

Insulated Gate Bipolar Transistor with Ultrafast Soft Recovery Diode

$V_{CES} = 600V$
$I_C = 15A, T_C = 100^\circ C$
$t_{sc} > 5\mu s, T_{jmax} = 175^\circ C$
$V_{CE(on) typ.} = 1.55V @ 8A$

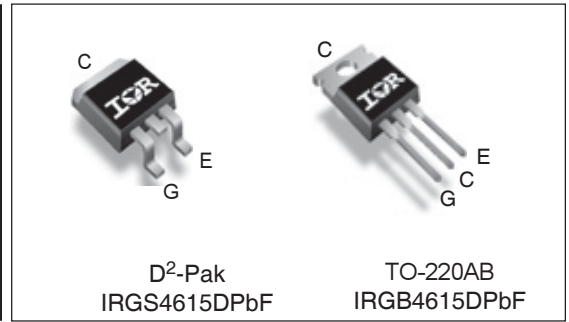
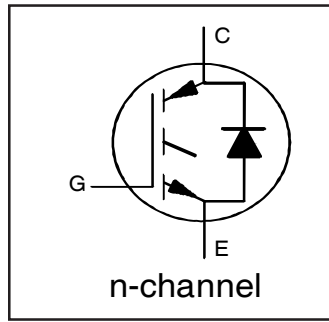

G	C	E
Gate	Collector	Emitter

Applications

- Appliance Drives
- Inverters
- UPS

Features	Benefits
Low $V_{CE(ON)}$ and switching losses	High efficiency in a wide range of applications and switching frequencies
Square RBSOA and maximum junction temperature 175°C	Improved reliability due to rugged hard switching performance and higher power capability
Positive $V_{CE(ON)}$ temperature coefficient and tighter distribution of parameters	Excellent current sharing in parallel operation
5µs short circuit SOA	Enables short circuit protection scheme
Lead-free, RoHS compliant	Environmentally friendly

Base part number	Package Type	Standard Pack □		Orderable Part Number
		Form	Quantity	
IRGS4615DPbF	D² PAK	Tube	50	IRGS4615DPbF
IRGS4615DTRRPbF		Tape and Reel Right	800	IRGS4615DTRRPbF
IRGS4615DTRLpBf		Tape and Reel Left	800	IRGS4615DTRLpBf
IRGB4615DPbF	TO-220AB	Tube	50	IRGB4615DPbF

Absolute Maximum Ratings

	Parameter	Max.	Units
V_{CES}	Collector-to-Emitter Breakdown Voltage	600	V
$I_C @ T_C = 25^\circ C$	Continuous Collector Current	23	A
$I_C @ T_C = 100^\circ C$	Continuous Collector Current	15	
I_{CM}	Pulsed Collector Current, $V_{GE} = 15V \text{Ⓞ}$	24	
I_{LM}	Clamped Inductive Load Current, $V_{GE} = 20V \text{Ⓞ}$	32	
$I_F @ T_C = 25^\circ C$	Diode Continuous Forward Current	14	
$I_F @ T_C = 100^\circ C$	Diode Continuous Forward Current	9	
I_{FM}	Diode Maximum Forward Current Ⓜ	32	
V_{GE}	Continuous Gate-to-Emitter Voltage	± 20	V
	Transient Gate-to-Emitter Voltage	± 30	
$P_D @ T_C = 25^\circ$	Maximum Power Dissipation	99	W
$P_D @ T_C = 100^\circ$	Maximum Power Dissipation	50	
T_J	Operating Junction and	-40 to + 175	°C
T_{STG}	Storage Temperature Range		
	Soldering Temperature, for 10 seconds (1.6mm from case)	300	
	Mounting Torque, 6-32 or M3 Screw TO-220	10lbf. In (1.1 N.m)	

Thermal Resistance^③

	Parameter	Min.	Typ.	Max.	Units
$R_{\theta JC}$	Thermal Resistance, Junction-to-Case -(each IGBT)	—	—	1.51	°C/W
$R_{\theta JC}$	Thermal Resistance, Junction-to-Case -(each Diode)	—	—	3.66	
$R_{\theta CS}$	Thermal Resistance, Case-to-Sink (flat, greased surface)	—	0.5	—	
$R_{\theta JA}$	Thermal Resistance, Junction-to-Ambient (PCB mount ^④ D ² PAK)	—	40	—	
	Thermal Resistance, Junction-to-Ambient (Socket mount: TO-220)	—	80	—	

Electrical Characteristics @ $T_J = 25^\circ\text{C}$ (unless otherwise specified)

	Parameter	Min.	Typ.	Max.	Units	Conditions
$V_{(BR)CES}$	Collector-to-Emitter Breakdown Voltage	600	—	—	V	$V_{GE} = 0V, I_C = 100\mu A$ ^⑤
$\Delta V_{(BR)CES}/\Delta T_J$	Temperature Coeff. of Breakdown Voltage	—	0.3	—	V/°C	$V_{GE} = 0V, I_C = 250\mu A$ (25 -175 °C) ^⑤
$V_{CE(on)}$	Collector-to-Emitter Saturation Voltage	—	1.55	1.85	V	$I_C = 8.0A, V_{GE} = 15V, T_J = 25^\circ\text{C}$
		—	1.95	—		$I_C = 8.0A, V_{GE} = 15V, T_J = 150^\circ\text{C}$
		—	2.00	—		$I_C = 8.0A, V_{GE} = 15V, T_J = 175^\circ\text{C}$
$V_{GE(th)}$	Gate Threshold Voltage	4.0	—	6.5	V	$V_{CE} = V_{GE}, I_C = 250\mu A$
$\Delta V_{GE(th)}/\Delta T_J$	Threshold Voltage temp. coefficient	—	-18	—	mV/°C	$V_{CE} = V_{GE}, I_C = 250\mu A$ (25 -175 °C)
g_{fe}	Forward Transconductance	—	5.6	—	S	$V_{CE} = 50V, I_C = 8.0A, PW = 80\mu s$
I_{CES}	Collector-to-Emitter Leakage Current	—	—	25	μA	$V_{GE} = 0V, V_{CE} = 600V$
		—	400	—		$V_{GE} = 0V, V_{CE} = 600V, T_J = 175^\circ\text{C}$
V_{FM}	Diode Forward Voltage Drop	—	1.80	2.8	V	$I_F = 8.0A$
		—	1.30	—		$I_F = 8.0A, T_J = 175^\circ\text{C}$
I_{GES}	Gate-to-Emitter Leakage Current	—	—	± 100	nA	$V_{GE} = \pm 20V$

Switching Characteristics @ $T_J = 25^\circ\text{C}$ (unless otherwise specified)

	Parameter	Min.	Typ.	Max.	Units	Conditions
Q_g	Total Gate Charge (turn-on)	—	19	—	nC	$I_C = 8.0A$
Q_{ge}	Gate-to-Emitter Charge (turn-on)	—	5	—		$V_{CC} = 400V$
Q_{gc}	Gate-to-Collector Charge (turn-on)	—	8	—		$V_{GE} = 15V$
E_{on}	Turn-On Switching Loss	—	70	—	μJ	$I_C = 8.0A, V_{CC} = 400V, V_{GE} = 15V$
E_{off}	Turn-Off Switching Loss	—	145	—		$R_G = 47\Omega, L = 1mH, L_S = 150nH, T_J = 25^\circ\text{C}$
E_{total}	Total Switching Loss	—	215	—		Energy losses include tail and diode reverse recovery
$t_{d(on)}$	Turn-On delay time	—	30	—	ns	$I_C = 8.0A, V_{CC} = 400V$
t_r	Rise time	—	15	—		$R_G = 47\Omega, L = 1mH, L_S = 150nH$
$t_{d(off)}$	Turn-Off delay time	—	95	—		$T_J = 25^\circ\text{C}$
t_f	Fall time	—	20	—	μJ	$I_C = 8.0A, V_{CC} = 400V, V_{GE} = 15V$
E_{on}	Turn-On Switching Loss	—	165	—		$R_G = 47\Omega, L = 1mH, L_S = 150nH, T_J = 175^\circ\text{C}$
E_{off}	Turn-Off Switching Loss	—	240	—		Energy losses include tail and diode reverse recovery
E_{total}	Total Switching Loss	—	405	—	ns	$I_C = 8.0A, V_{CC} = 400V$
$t_{d(on)}$	Turn-On delay time	—	28	—		$R_G = 47\Omega, L = 1mH, L_S = 150nH$
t_r	Rise time	—	17	—		$T_J = 175^\circ\text{C}$
$t_{d(off)}$	Turn-Off delay time	—	117	—	pF	$V_{GE} = 0V$
t_f	Fall time	—	35	—		$V_{CC} = 30V$
C_{ies}	Input Capacitance	—	535	—		$f = 1Mhz$
C_{oes}	Output Capacitance	—	45	—	FULL SQUARE	$T_J = 175^\circ\text{C}, I_C = 32A$
C_{res}	Reverse Transfer Capacitance	—	15	—		$V_{CC} = 480V, V_p = 600V$
RBSOA	Reverse Bias Safe Operating Area					$R_G = 47\Omega, V_{GE} = +20V$ to 0V
SCSOA	Short Circuit Safe Operating Area	5	—	—	μs	$V_{CC} = 400V, V_p = 600V$
E_{rec}	Reverse recovery energy of the diode	—	165	—	μJ	$R_G = 47\Omega, V_{GE} = +15V$ to 0V
t_{rr}	Diode Reverse recovery time	—	60	—	ns	$T_J = 175^\circ\text{C}$
I_{rr}	Peak Reverse Recovery Current	—	14	—	A	$V_{CC} = 400V, I_F = 8.0A$
		—	14	—		$V_{GE} = 15V, R_G = 47\Omega, L = 1mH, L_S = 150nH$

Notes:

- ① $V_{CC} = 80\% (V_{CES}), V_{GE} = 20V, L = 100\mu H, R_G = 47\Omega.$
- ② Pulse width limited by max. junction temperature.
- ③ R_{θ} is measured at T_J approximately $90^\circ\text{C}.$
- ④ When mounted on 1" square PCB (FR-4 or G-10 Material). For recommended footprint and soldering techniques refer to application note #AN-994
- ⑤ Refer to AN-1086 for guidelines for measuring $V_{(BR)CES}$ safely.

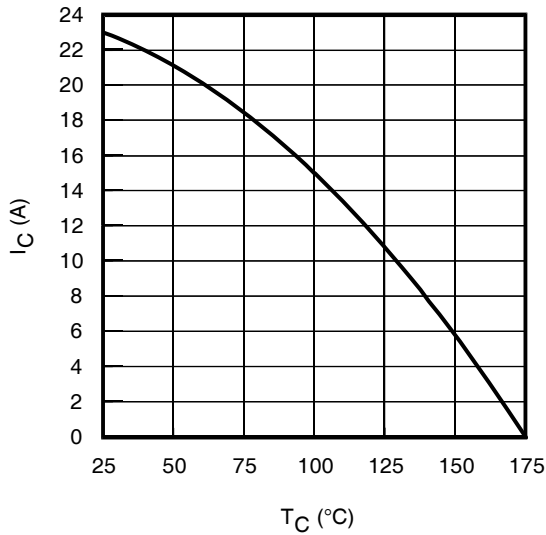

Fig. 1 - Maximum DC Collector Current vs. Case Temperature

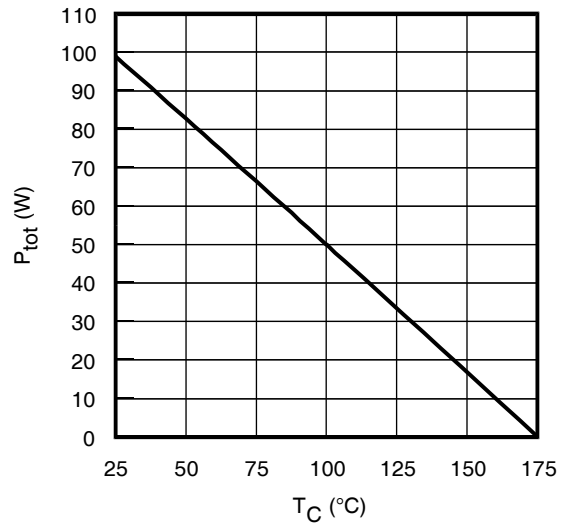
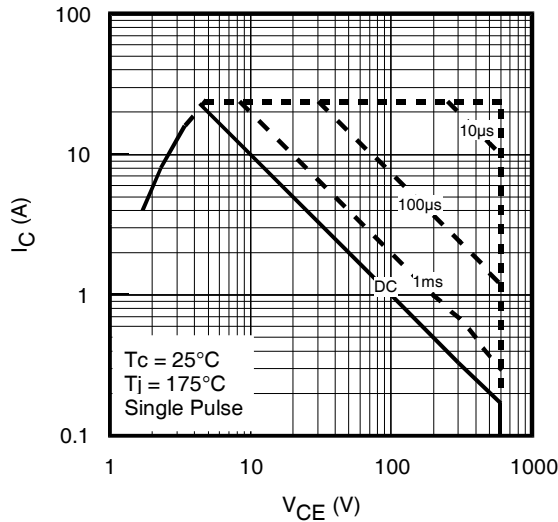
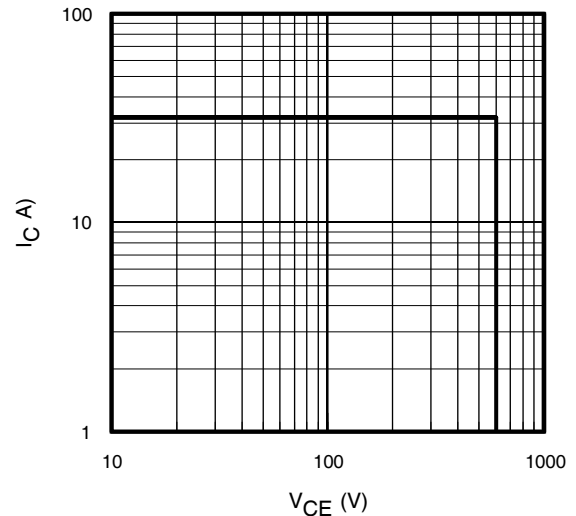

Fig. 2 - Power Dissipation vs. Case Temperature



**Fig. 3 - Forward SOA,
T_C = 25°C; T_J ≤ 175°C**



**Fig. 4 - Reverse Bias SOA
T_J = 175°C; V_{CE} = 15V**

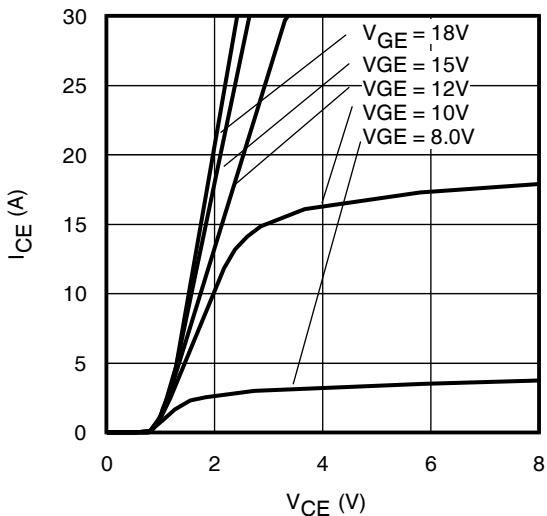

**Fig. 5 - Typ. IGBT Output Characteristics
T_J = -40°C; t_p = 80µs**

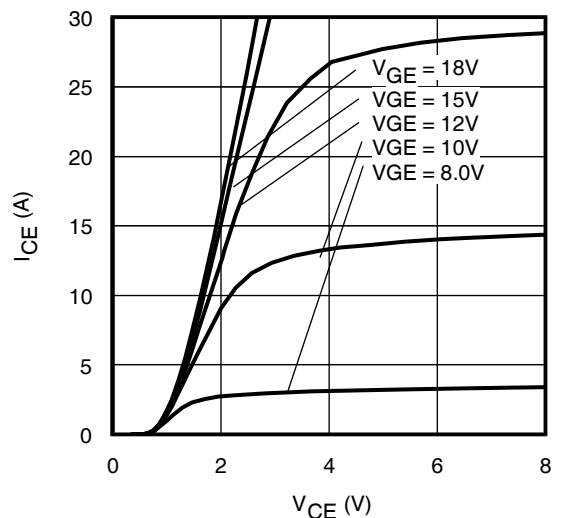

**Fig. 6 - Typ. IGBT Output Characteristics
T_J = 25°C; t_p = 80µs**

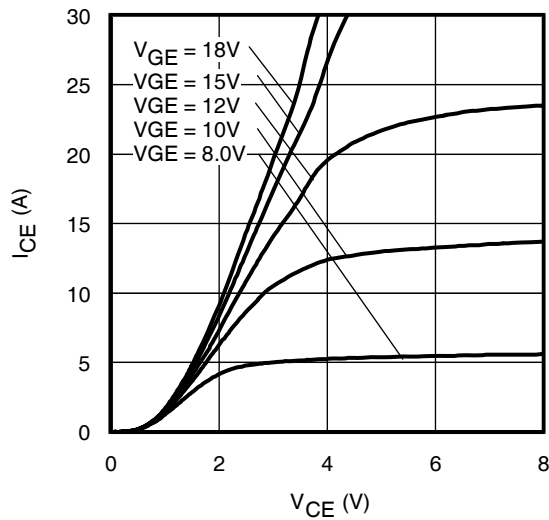

Fig. 7 - Typ. IGBT Output Characteristics
 $T_J = 175^\circ\text{C}$; $t_p = 80\mu\text{s}$

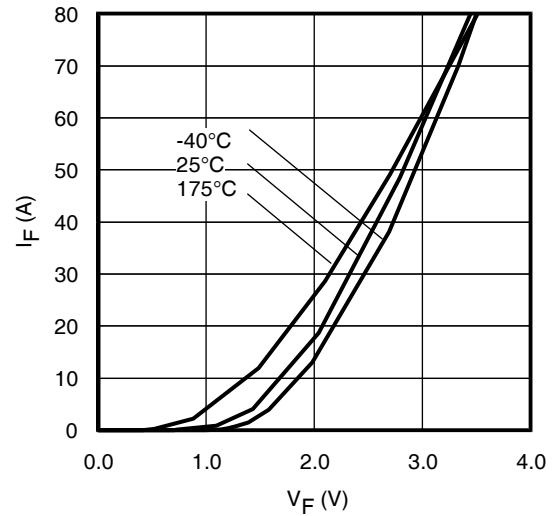

Fig. 8 - Typ. Diode Forward Characteristics
 $t_p = 80\mu\text{s}$

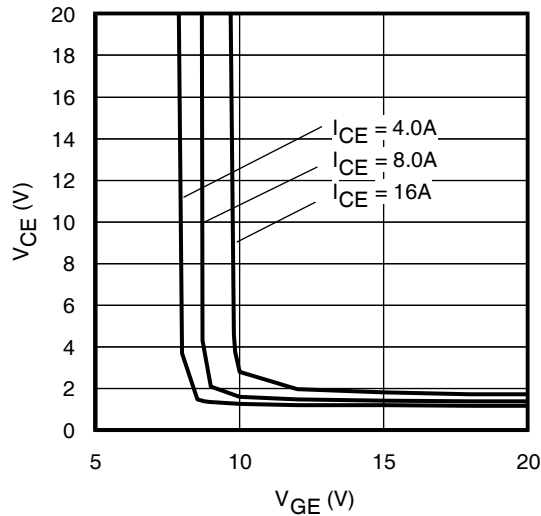

Fig. 9 - Typical V_{CE} vs. V_{GE}
 $T_J = -40^\circ\text{C}$

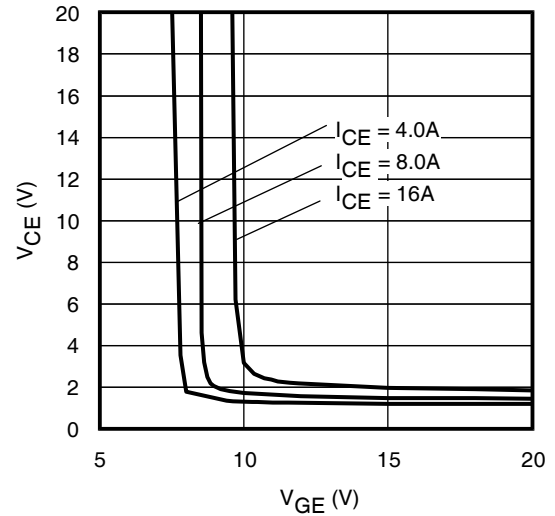

Fig. 10 - Typical V_{CE} vs. V_{GE}
 $T_J = 25^\circ\text{C}$

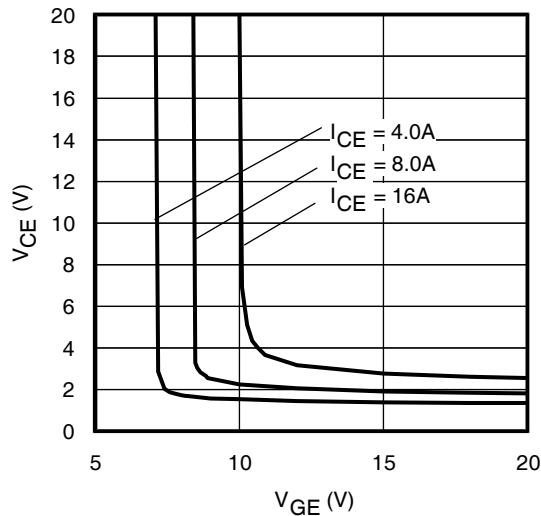

Fig. 11 - Typical V_{CE} vs. V_{GE}
 $T_J = 175^\circ\text{C}$

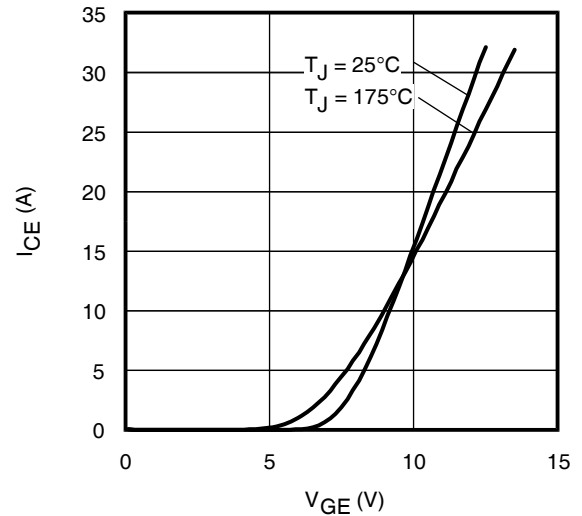

Fig. 12 - Typ. Transfer Characteristics
 $V_{CE} = 50\text{V}$; $t_p = 10\mu\text{s}$

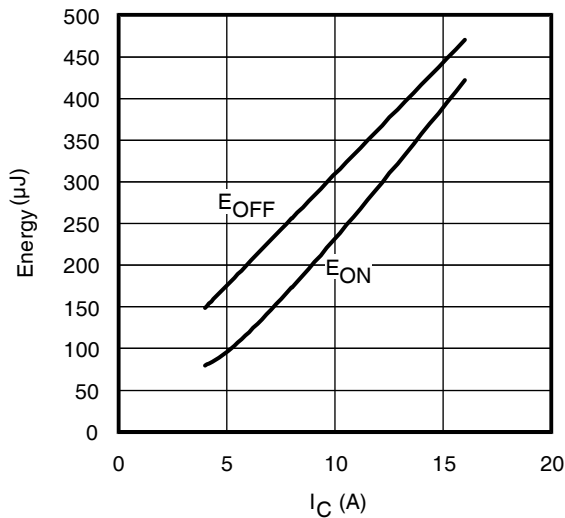

Fig. 13 - Typ. Energy Loss vs. I_C
 $T_J = 175^\circ C$; $L = 1mH$; $V_{CE} = 400V$, $R_G = 47\Omega$; $V_{GE} = 15V$.

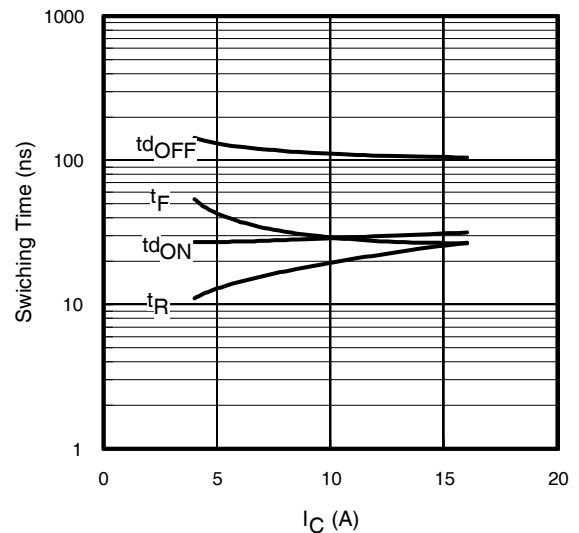

Fig. 14 - Typ. Switching Time vs. I_C
 $T_J = 175^\circ C$; $L = 1mH$; $V_{CE} = 400V$
 $R_G = 47\Omega$; $V_{GE} = 15V$

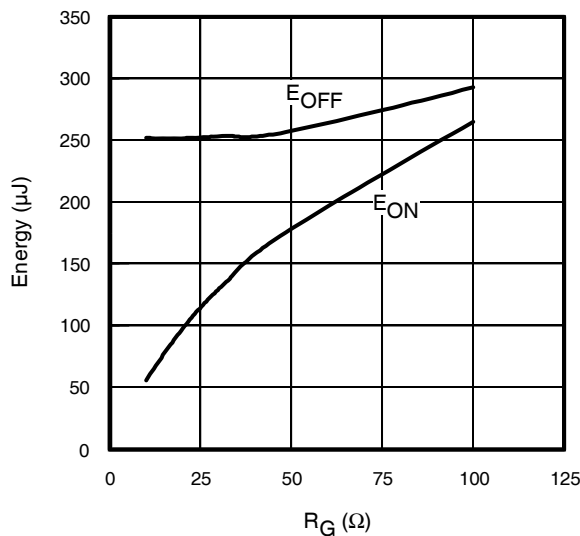

Fig. 15 - Typ. Energy Loss vs. R_G
 $T_J = 175^\circ C$; $L = 1mH$; $V_{CE} = 400V$, $I_{CE} = 8A$; $V_{GE} = 15V$

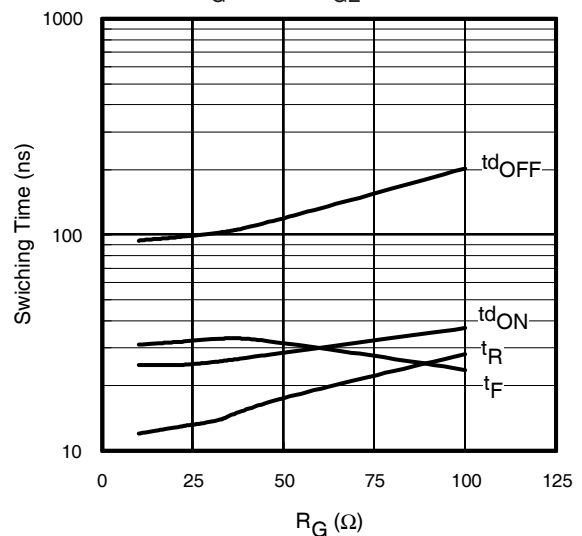

Fig. 16 - Typ. Switching Time vs. R_G
 $T_J = 175^\circ C$; $L = 1mH$; $V_{CE} = 400V$
 $I_{CE} = 8A$; $V_{GE} = 15V$

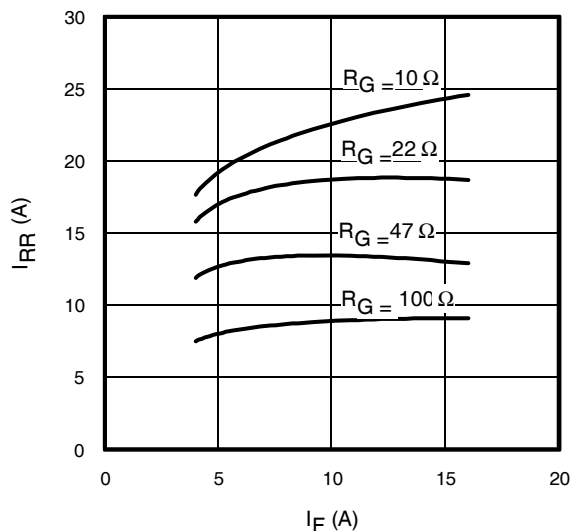

Fig. 17 - Typical Diode I_{RR} vs. I_F
 $T_J = 175^\circ C$

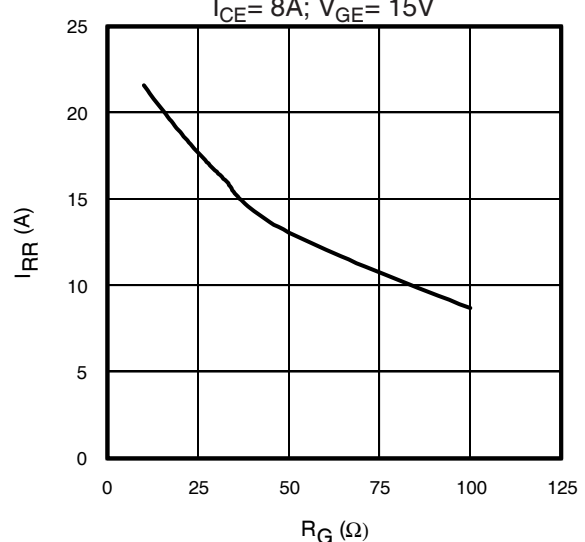

Fig. 18 - Typical Diode I_{RR} vs. R_G
 $T_J = 175^\circ C$; $I_F = 8.0A$

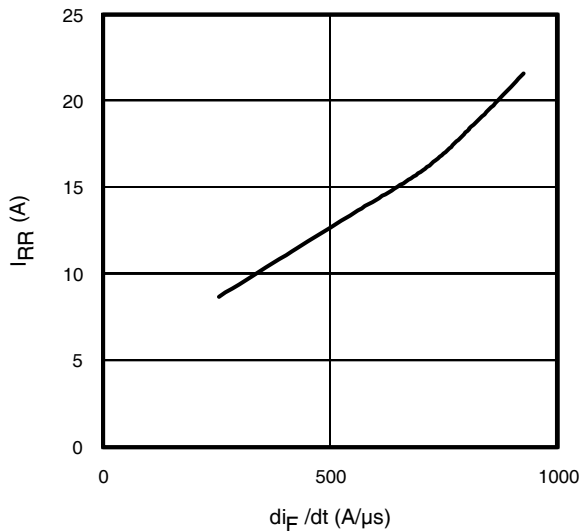

Fig. 19 - Typical Diode I_{RR} vs. di_F/dt
 $V_{CC}=400V$; $V_{GE}=15V$;
 $I_{CE}=8A$; $T_J=175^\circ C$

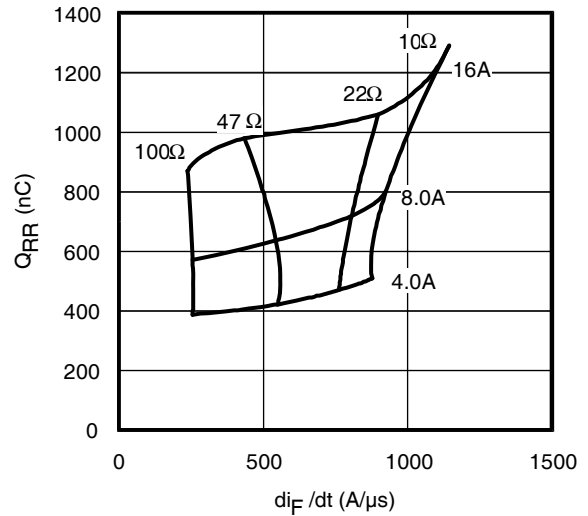

Fig. 20 - Typical Diode Q_{RR}
 $V_{CC}=400V$; $V_{GE}=15V$; $T_J=175^\circ C$

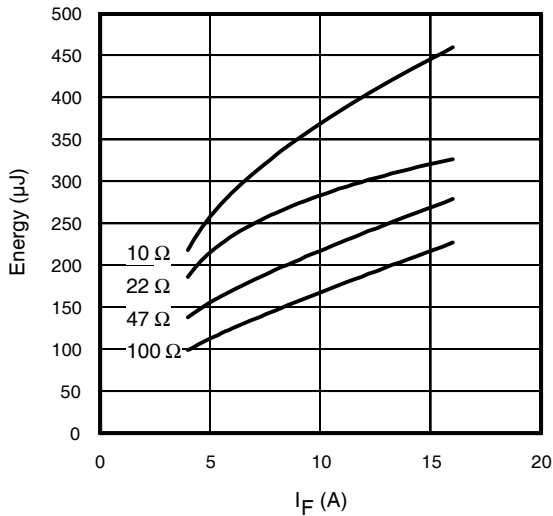

Fig. 21 - Typical Diode E_{RR} vs. I_F
 $T_J=175^\circ C$

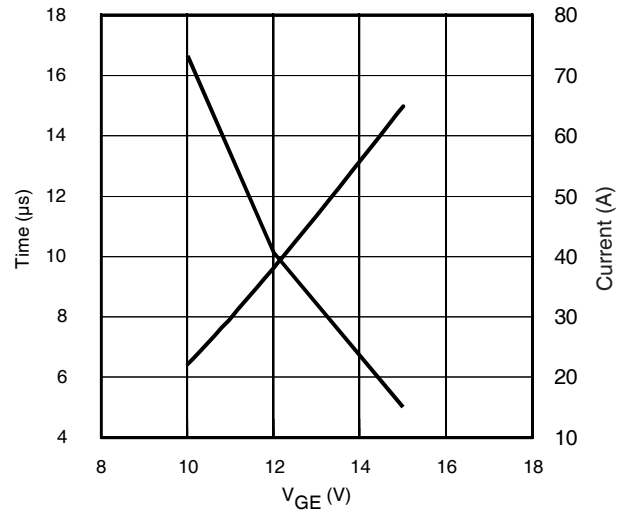

Fig. 22 - Typ. V_{GE} vs Short Circuit Time
 $V_{CC}=400V$, $T_C=25^\circ C$

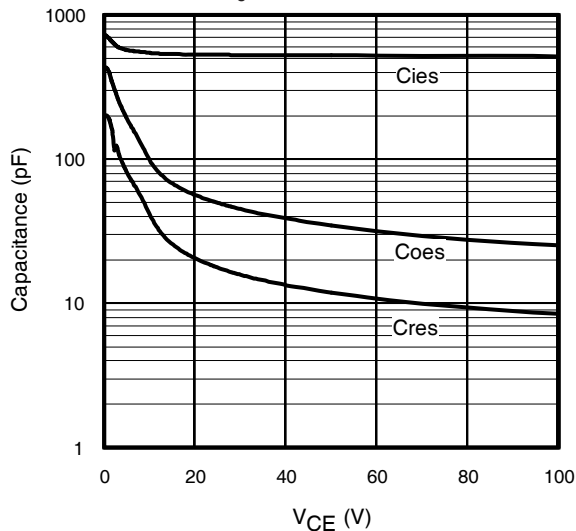

Fig. 23 - Typ. Capacitance vs. V_{CE}
 $V_{GE}=0V$; $f=1MHz$

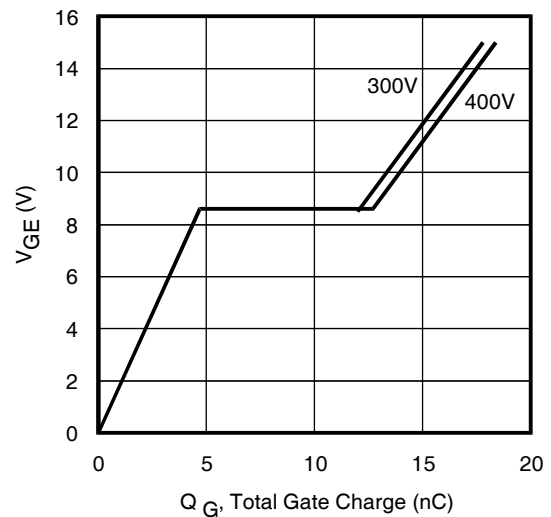
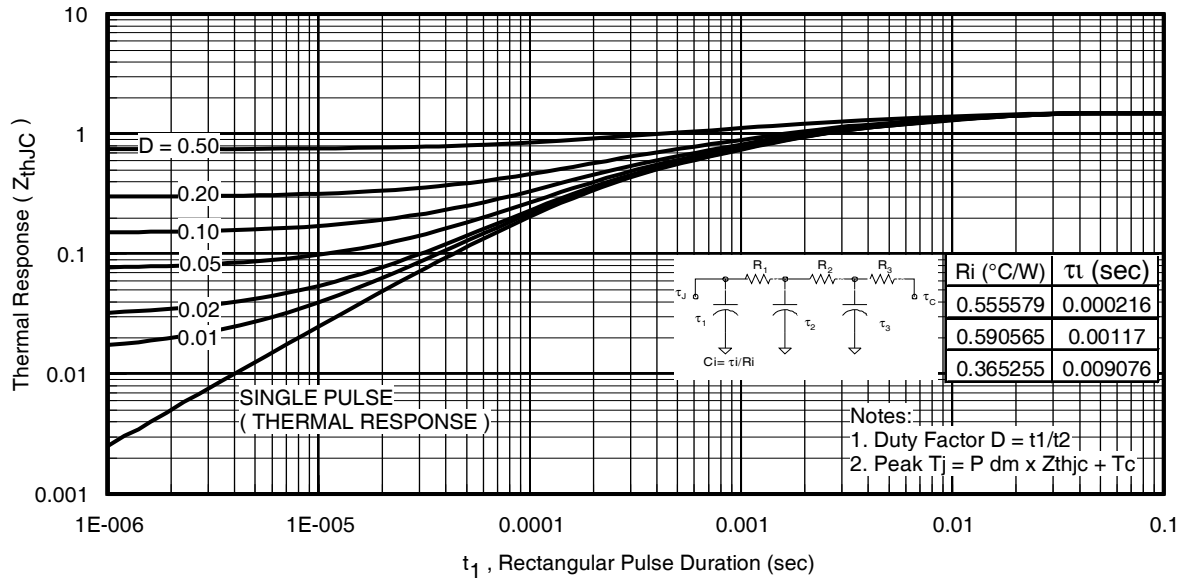
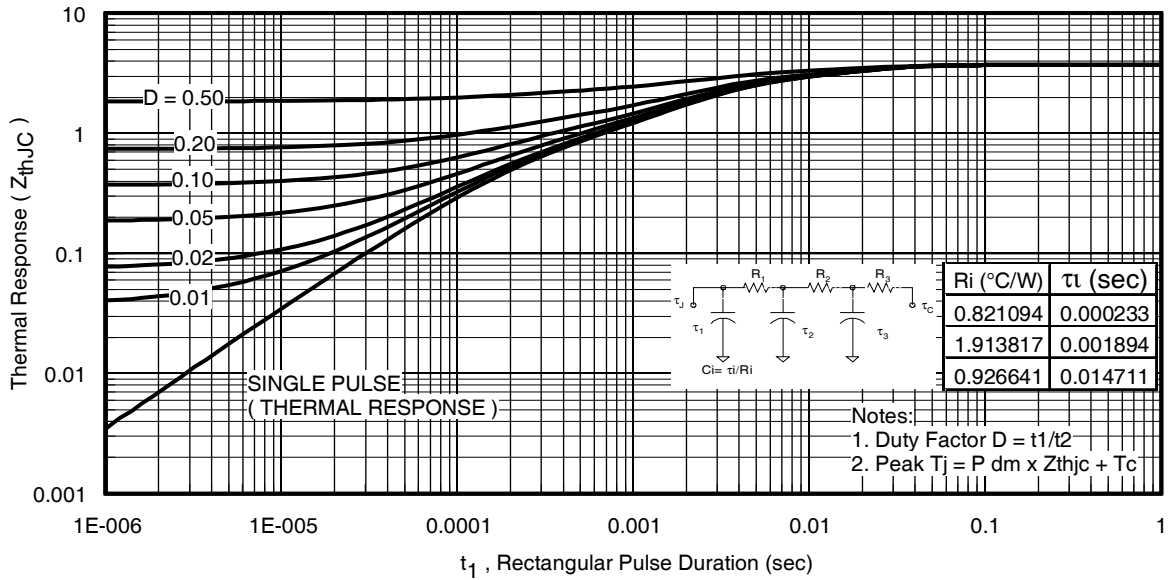

Fig. 24 - Typical Gate Charge vs. V_{GE}
 $I_{CE}=8A$, $L=600\mu H$

Fig 25. Maximum Transient Thermal Impedance, Junction-to-Case (IGBT)

Fig. 26. Maximum Transient Thermal Impedance, Junction-to-Case (DIODE)

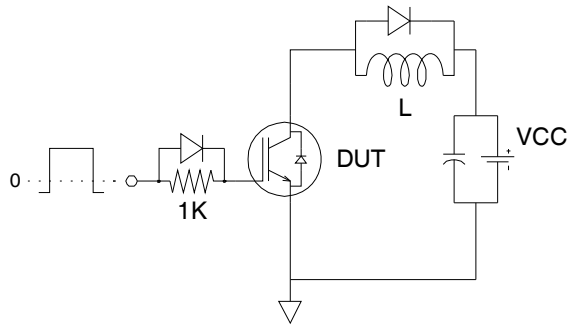
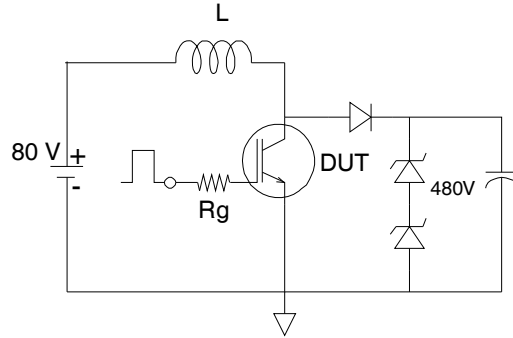
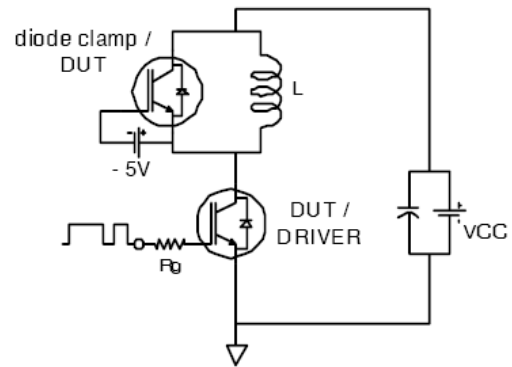
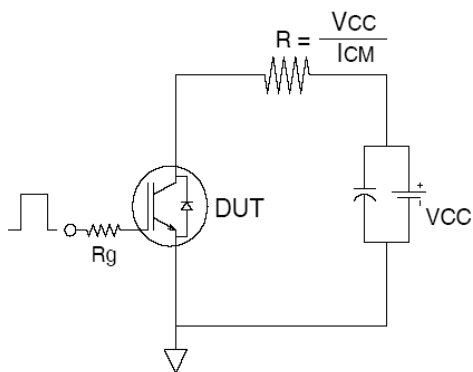
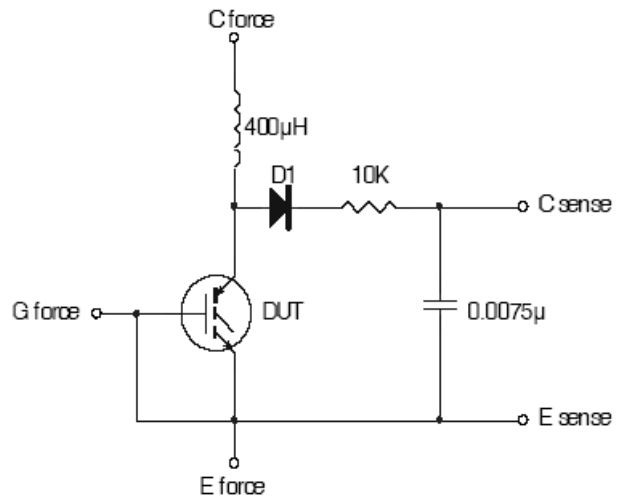

Fig.C.T.1 - Gate Charge Circuit (turn-off)

Fig.C.T.2 - RBSOA Circuit

Fig.C.T.3 - S.C.SOA Circuit

Fig.C.T.4 - Switching Loss Circuit

Fig.C.T.5 - Resistive Load Circuit

Fig.C.T.6 - Typical Filter Circuit for $V_{(BR)CES}$ Measurement

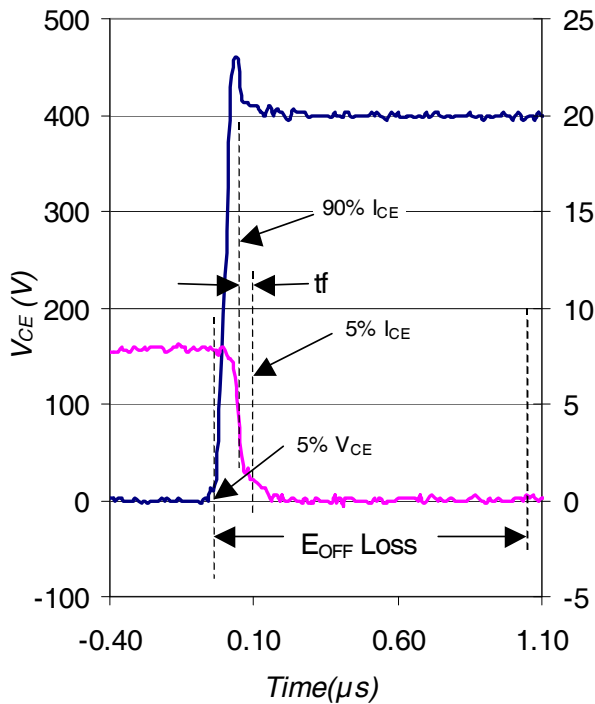

Fig. WF1 - Typ. Turn-off Loss Waveform
@ $T_J = 175^\circ\text{C}$ using Fig. CT.4

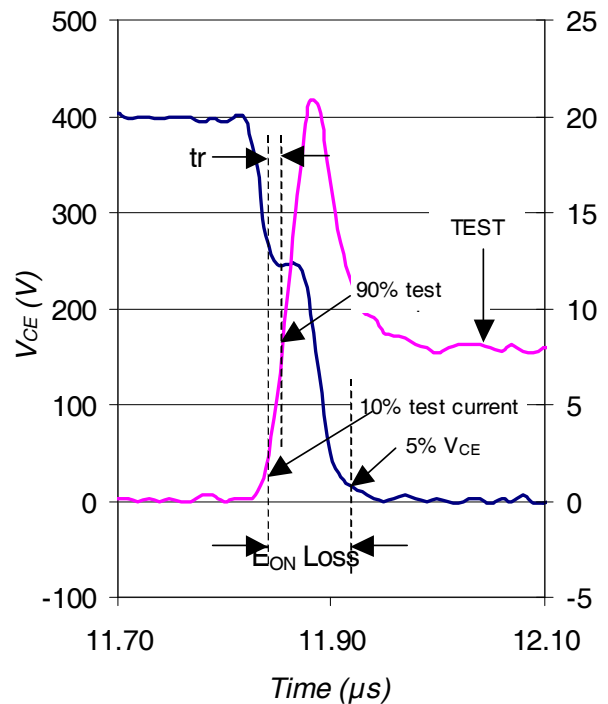
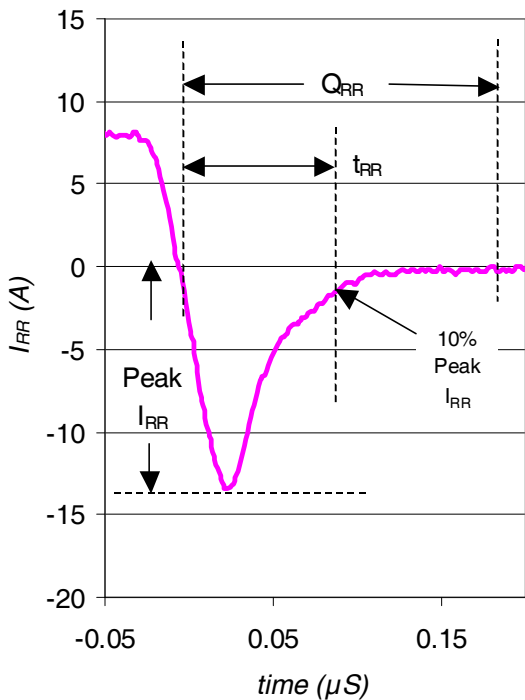
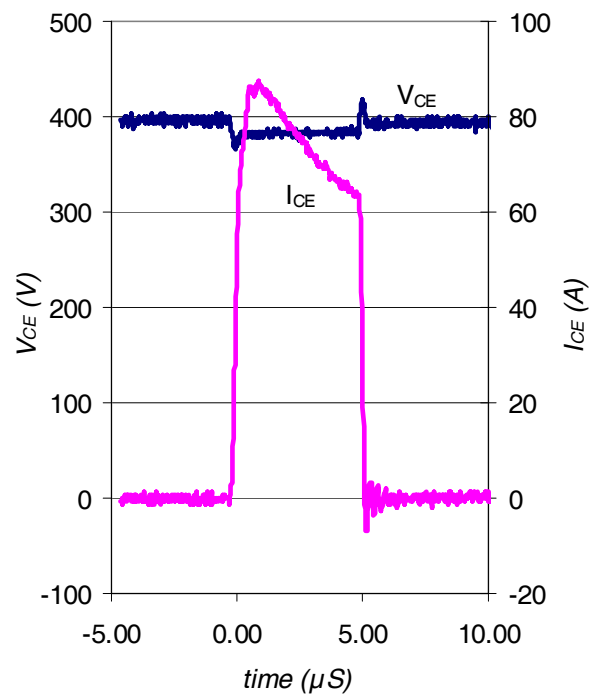

Fig. WF2 - Typ. Turn-on Loss Waveform
@ $T_J = 175^\circ\text{C}$ using Fig. CT.4



WF.3- Typ. Reverse Recovery Waveform
@ $T_J = 175^\circ\text{C}$ using CT.4



WF.4- Typ. Short Circuit Waveform
@ $T_J = 25^\circ\text{C}$ using CT.3

TO-220AB Package Outline (Dimensions are shown in millimeters (inches))

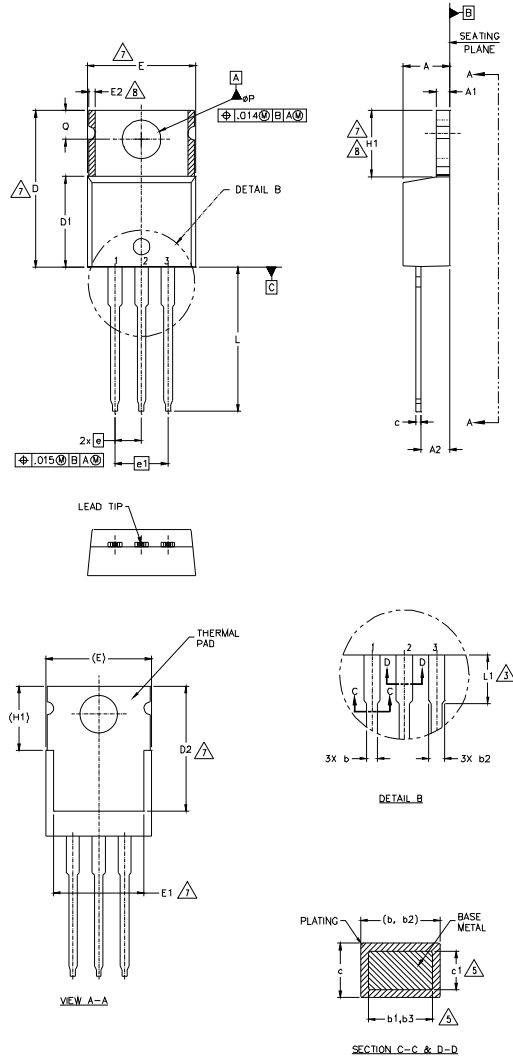
NOTES:

- 1.- DIMENSIONING AND TOLERANCING AS PER ASME Y14.5 M- 1994.
- 2.- DIMENSIONS ARE SHOWN IN INCHES [MILLIMETERS].
- 3.- LEAD DIMENSION AND FINISH UNCONTROLLED IN L1.
- 4.- DIMENSION D, D1 & E DO NOT INCLUDE MOLD FLASH. MOLD FLASH SHALL NOT EXCEED .005" (0.127) PER SIDE. THESE DIMENSIONS ARE MEASURED AT THE OUTERMOST EXTREMES OF THE PLASTIC BODY.
- 5.- DIMENSION b1, b3 & c1 APPLY TO BASE METAL ONLY.
- 6.- CONTROLLING DIMENSION : INCHES.
- 7.- THERMAL PAD CONTOUR OPTIONAL WITHIN DIMENSIONS E,H1,D2 & E1
- 8.- DIMENSION E2 X H1 DEFINE A ZONE WHERE STAMPING AND SINGULATION IRREGULARITIES ARE ALLOWED.
- 9.- OUTLINE CONFORMS TO JEDEC TO-220, EXCEPT A2 (max.) AND D2 (min.) WHERE DIMENSIONS ARE DERIVED FROM THE ACTUAL PACKAGE OUTLINE.

SYMBOL	DIMENSIONS				NOTES
	MILLIMETERS		INCHES		
	MIN.	MAX.	MIN.	MAX.	
A	3.56	4.83	.140	.190	
A1	0.51	1.40	.020	.055	
A2	2.03	2.92	.080	.115	
b	0.38	1.01	.015	.040	
b1	0.38	0.97	.015	.038	5
b2	1.14	1.78	.045	.070	
b3	1.14	1.73	.045	.068	5
c	0.36	0.61	.014	.024	
c1	0.36	0.56	.014	.022	5
D	14.22	16.51	.560	.650	4
D1	8.38	9.02	.330	.355	
D2	11.68	12.88	.460	.507	7
E	9.65	10.67	.380	.420	4,7
E1	6.86	8.89	.270	.350	7
E2	-	0.76	-	.030	8
e	2.54 BSC		.100 BSC		
e1	5.08 BSC		.200 BSC		
H1	5.84	6.86	.230	.270	7,8
L	12.70	14.73	.500	.580	
L1	-	6.35	-	.250	3
øP	3.54	4.08	.139	.161	
Q	2.54	3.42	.100	.135	

LEAD ASSIGNMENTS
HEXFET

- 1.- GATE
- 2.- DRAIN
- 3.- SOURCE

IGBTs, CoPACK

- 1.- GATE
- 2.- COLLECTOR
- 3.- EMITTER

DIODES

- 1.- ANODE/OPEN
- 2.- CATHODE
- 3.- ANODE

TO-220AB Part Marking Information

EXAMPLE: THIS IS AN IRF1010
 LOT CODE 1789
 ASSEMBLED ON VVW 19, 2000
 IN THE ASSEMBLY LINE "C"

Note: "P" in assembly line position indicates "Lead-Free"

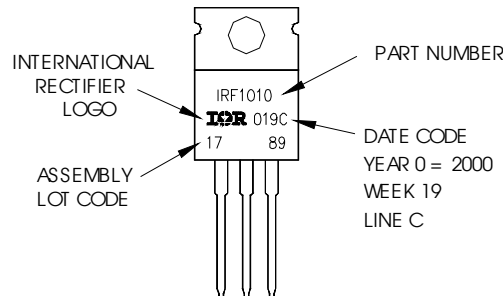

TO-220AB packages are not recommended for Surface Mount Application.

Note: For the most current drawing please refer to IR website at <http://www.irf.com/package/>

D²Pak Package Outline

Dimensions are shown in millimeters (inches)

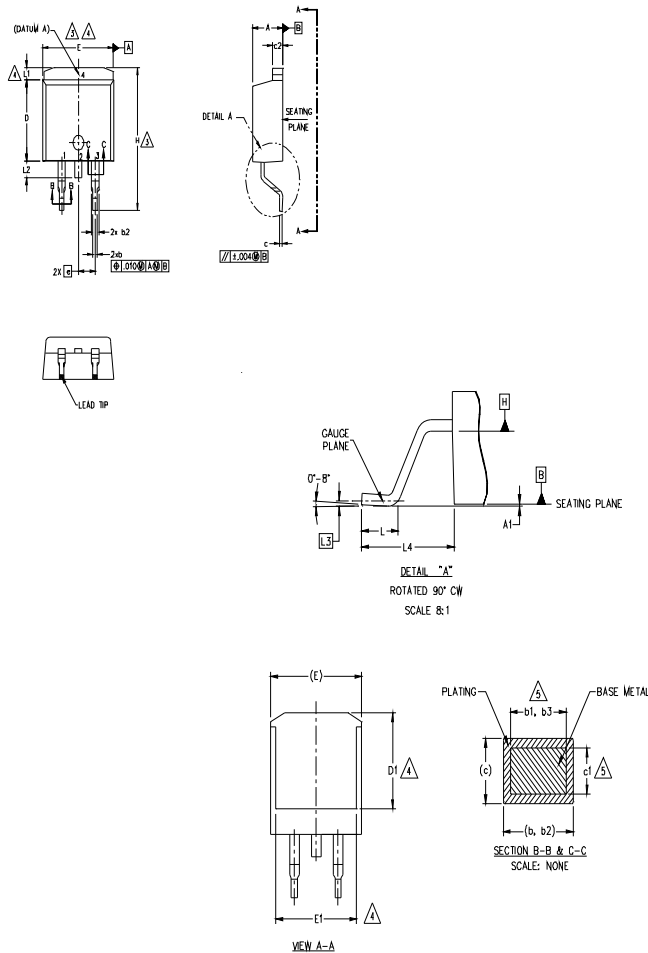

SYMBOL	DIMENSIONS				NOTES
	MILLIMETERS		INCHES		
	MIN.	MAX.	MIN.	MAX.	
A	4.06	4.83	.160	.190	5
A1	0.00	0.254	.000	.010	
b	0.51	0.99	.020	.039	
b1	0.51	0.89	.020	.035	
b2	1.14	1.78	.045	.070	
b3	1.14	1.73	.045	.068	
c	0.38	0.74	.015	.029	
c1	0.38	0.58	.015	.023	
c2	1.14	1.65	.045	.065	
D	8.38	9.65	.330	.380	
D1	6.86	—	.270	—	4
E	9.65	10.67	.380	.420	3,4
E1	6.22	—	.245	—	4
e	2.54 BSC		.100 BSC		
H	14.61	15.88	.575	.625	4
L	1.78	2.79	.070	.110	
L1	—	1.65	—	.066	
L2	—	1.78	—	.070	
L3	0.25 BSC		.010 BSC		
L4	4.78	5.28	.188	.208	

- NOTES:
1. DIMENSIONING AND TOLERANCING PER ASME Y14.5M-1994
 2. DIMENSIONS ARE SHOWN IN MILLIMETERS [INCHES]
 3. DIMENSION D & E DO NOT INCLUDE MOLD FLASH; MOLD FLASH SHALL NOT EXCEED 0.127 [0.005] PER SIDE. THESE DIMENSIONS ARE MEASURED AT THE OUTMOST EXTREMES OF THE PLASTIC BODY AT DATUM H.
 4. THERMAL PAD CONTOUR OPTIONAL WITHIN DIMENSION E, L1, D1 & E1.
 5. DIMENSION b1 AND c1 APPLY TO BASE METAL ONLY.
 6. DATUM A & B TO BE DETERMINED AT DATUM PLANE H.
 7. CONTROLLING DIMENSION: INCH.
 8. OUTLINE CONFORMS TO JEDEC OUTLINE TO-263AB.

D²Pak Part Marking Information

EXAMPLE: THIS IS AN IRF530S WITH
 LOT CODE 8024
 ASSEMBLED ON WW 02, 2000
 IN THE ASSEMBLY LINE "L"

Note: "P" in assembly line position
 indicates "Lead - Free"

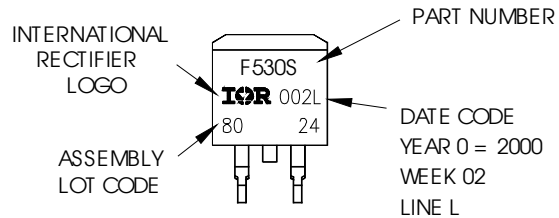

OR

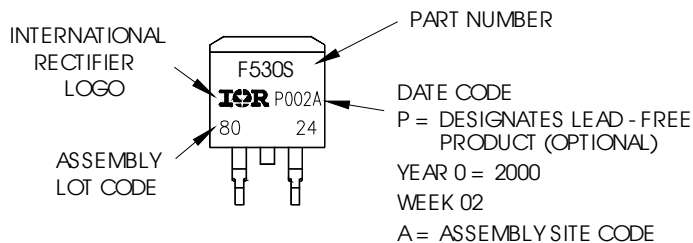

Note: For the most current drawing please refer to IR website at <http://www.irf.com/package/>

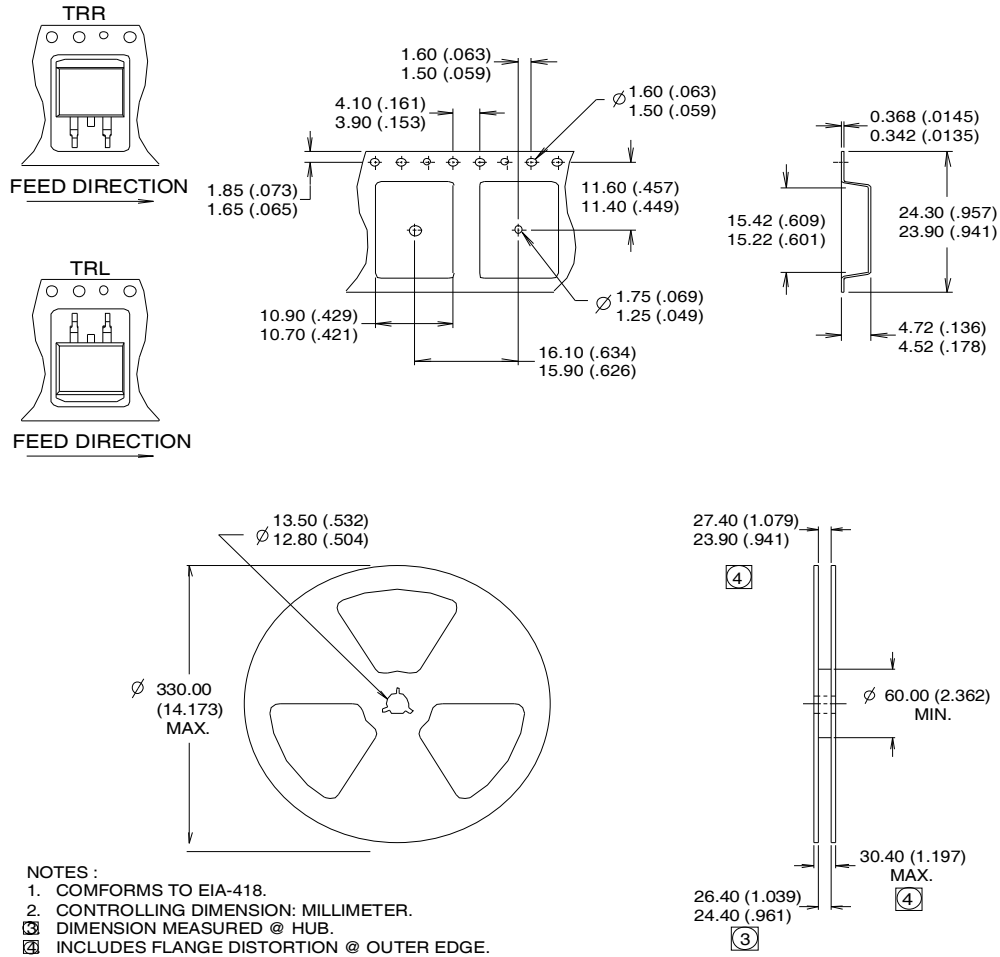
D²Pak Tape & Reel Information (Dimensions are shown in millimeters (inches))

Note: For the most current drawing please refer to IR website at <http://www.irf.com/package/>

Qualification Information[†]

Qualification Level	Industrial (per JEDEC JESD47F) ^{††}	
Moisture Sensitivity Level	D ² Pak	MSL1
	TO-220	N/A
RoHS Compliant	Yes	

[†] Qualification standards can be found at International Rectifier's web site: <http://www.irf.com/product-info/reliability>

^{††} Applicable version of JEDEC standard at the time of product release