

Part/Keyword Search



Detailed Drawing



Printer Friendly Datasheet

## PN3010 / SPN3010\*

\* Part number for additional environmental screening.

### Performance Data

Frequency	5.0 - 500.0 MHz
Gain	30.0 dB Typical 28.0 dB Min
Noise Figure	3.5 dB Typical 5.0 dB Max
P <sub>1dB</sub>	21.5 dBm Typical 20.0 dBm Min
3 <sup>rd</sup> Order Intercept	34.0 dBm Typical
2 <sup>nd</sup> Order Intercept	48.0 dBm Typical
VSWR	1.2/2.0 Input Typ/Max 1.8/2.0 Output Typ/Max
Reverse Isolation	-35.0 dB Typical -33.0 dB Min
Power Supply	12.0 Volts 130.0 mA
Operating Temperature	-55.0 - 85.0 °C

### Package Drawing

#### SM-11 (Surface Mount)

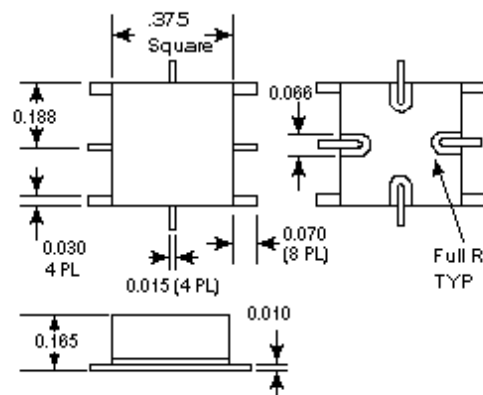

### Gain

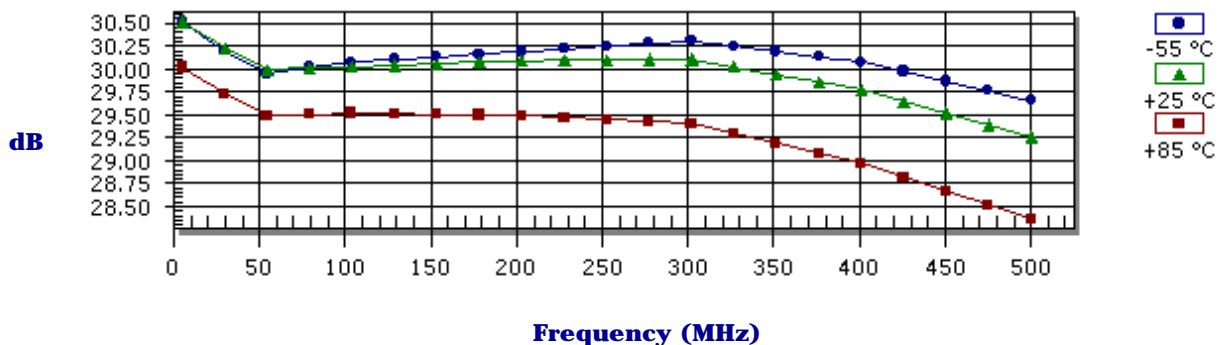

### Noise Figure

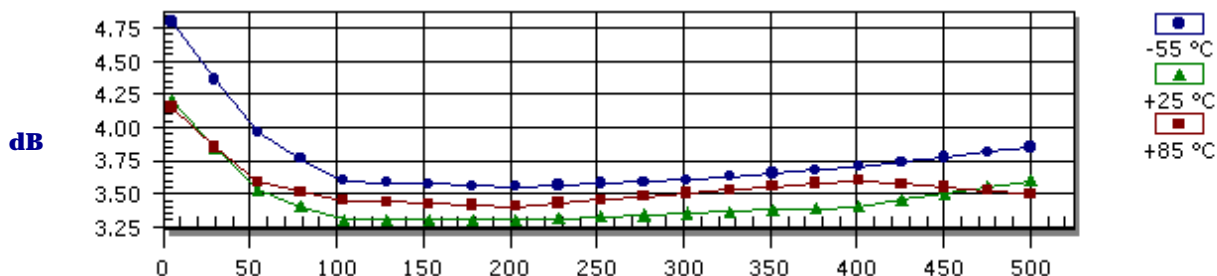

- Products
- Amplifiers
- VCOs
- Limiting Amplifiers
- Switches
- Linearizers
- Limiters
- Analog Attenuators
- Digital Attenuators
- Detectors

Frequency (MHz)

### $P_{1dB}$ Compression Point

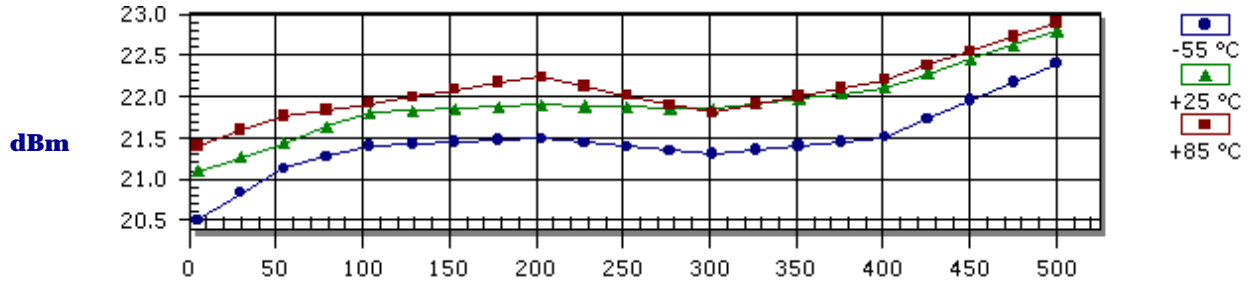

Frequency (MHz)

### Reverse Isolation

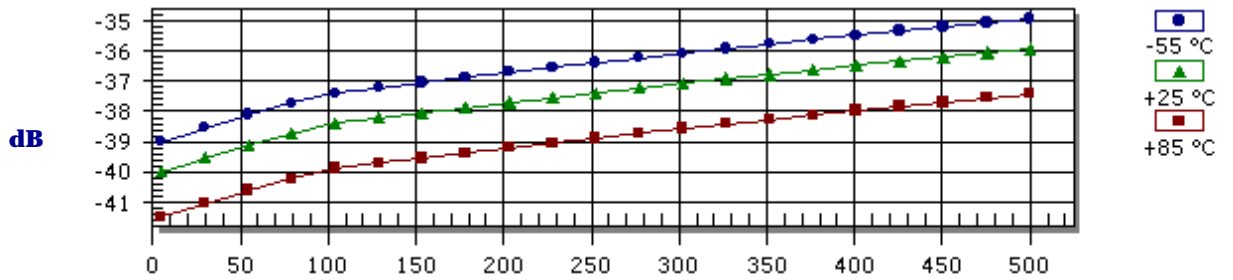

Frequency (MHz)

### Input VSWR

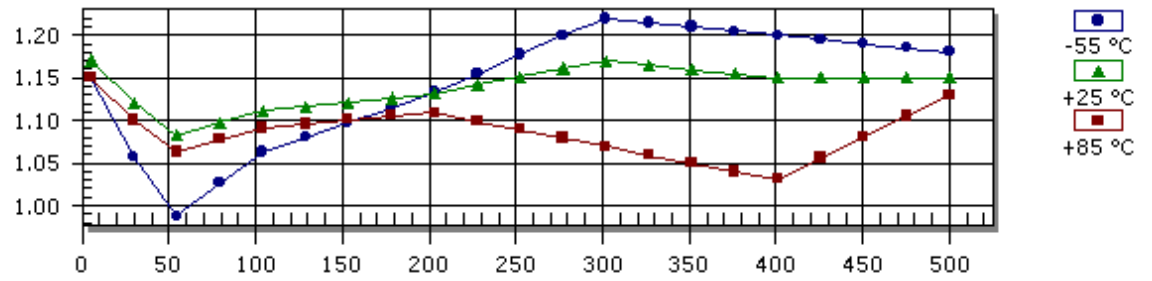

Frequency (MHz)

### Output VSWR

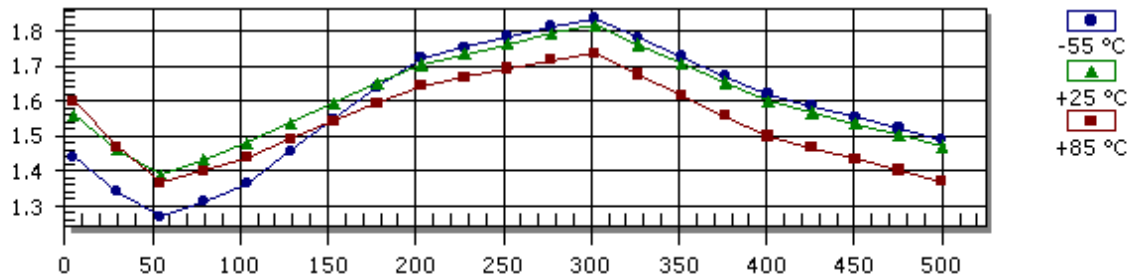

Frequency (MHz)

## S-Parameters

Frequency	S11 Mag	S11 Ang	S21 Mag	S21 Ang	S12 Mag	S12 Ang	S22 Mag	S22 Ang
5.0	0.080	105.00	33.560	15.00	0.010	13.00	0.220	-162.00
50.0	0.040	-30.00	31.600	-21.00	0.011	7.00	0.160	-165.00
100.0	0.050	-76.00	31.690	-44.00	0.012	9.00	0.190	-162.00
200.0	0.060	-149.00	31.970	-90.00	0.013	3.00	0.260	-176.00
300.0	0.080	148.00	32.040	-138.00	0.014	-1.00	0.290	163.00
400.0	0.070	78.00	30.840	172.00	0.015	-2.00	0.230	140.00
500.0	0.070	-45.00	29.030	121.00	0.016	-18.00	0.190	123.00

## Absolute Maximum Conditions

Maximum Operating Temperature	-55.0 - 100.0 °C	Maximum Storage Temperature	-62.0 - 125.0 °C
Maximum Case Temperature	125.0 °C	Maximum Supply Voltage	18.0 Volts
Continuous RF Input Power	13.0 dBm	Short Term RF Input Power (1 minute max)	50.0 mW
Maximum Peak Power (3 µsec max)	0.5 W		

Amplifonix | 2707 Black Lake Place | Philadelphia, PA 19154  
Tel: 215.464.4000 | FAX: 215.464.4001 | Email: [info@amplifonix.com](mailto:info@amplifonix.com)

# i2 Technologies US, Inc.

## HTML Pages converted to PDF Document

This document contains component information from the manufacturer's website which are not available in a revision controlled document from the manufacturer. To facilitate the addition of these parts into the Electronics Database, we are converting the HTML pages related to that part, from the manufacturer's website into Adobe PDF format. The contents of this document is based on the information provided on the manufacturer's website, therefore the information may have been changed by the manufacturer since this was created.

