

FEATURES

- SHIELDED POWER INDUCTOR
- HIGH CURRENT (UP TO 19.9 AMPS)
- SURFACE MOUNTABLE CONSTRUCTION
- HIGH INDUCTANCE (UP TO 3,300μH)
- TAPED AND REELED FOR AUTOMATIC INSERTION
- FOR USE IN DC/DC CONVERTERS

RoHS Compliant
includes all homogeneous materials

*See Part Number System for Details



CHARACTERISTICS

Case Size	NPIS62H	NPIS64H	NPIS73H	NPIS74H	NPIS14H
Inductance Range	3.3 ~ 330μH	10 ~ 1,000μH	10 ~ 1,000μH	10 ~ 1,000μH	4.7 ~ 470μH
Case Size	NPIS24H	NPIS25H	NPIS27H	NPIS29H	
Inductance Range	1.0 ~ 330μH	1.0 ~ 1,000μH	1.0 ~ 1,000μH	1.0 ~ 3,300μH	
Ambient Operating Temperature Range	-40°C ~ +125°C (including temperature rise)				
Temperature Rise at Irms	+40°C max.				
Inductance Change at Isat	-25% typical				
Inductance Tolerance	10% (K), 15% (L), 20% (M), 30% (Y)				
Resistance to Solder Heat	260°C for 10 seconds				

DIMENSIONS (mm)

Series	A	B	C	G	H	L
NPIS62H	6.8	7.0	3.0	4.6	1.9	7.4
NPIS64H	6.8	7.0	5.0	4.6	1.9	7.4
NPIS73H	7.8	7.8	4.0	4.8	2.2	8.0
NPIS74H	7.8	7.8	5.0	4.8	2.2	8.0
NPIS14H	10.5	10.5	5.0	6.8	4.4	10.8
NPIS24H	12.5	12.5	5.0	7.0	5.4	12.8
NPIS25H	12.5	12.5	6.0	7.0	5.4	12.8
NPIS27H	12.5	12.5	8.0	7.0	5.4	12.8
NPIS29H	12.0 ± 0.5	12.0 ± 0.5	10.0	7.0	5.4	12.8

LAND PATTERN (All Sizes)

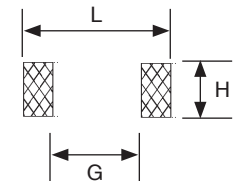

NPIS62H, NPIS64H

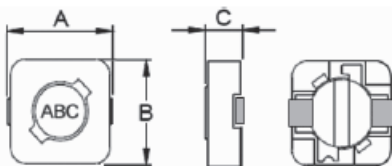

NPIS73H, NPIS74H

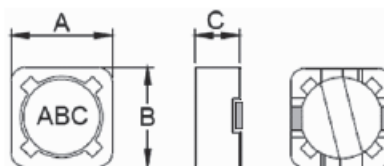

NPIS14H, NPIS24H, NPIS25H
NPIS27H, NPIS29H

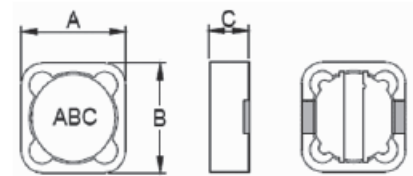

PART NUMBER SYSTEM

NPIS 24 H 560 M TR N F

- Series
- Size Code (see table for details)
- Construction Code (see drawing for details)
- Inductance Code (μH): 1st two digits are significant, 3rd digit is multiplier for values from 10μH and up.
- Inductance Tolerance Code: K=±10%, L=±15%, M=±20%, Y=±30%
- Packaging: TR = Tape & Reel
- Optional 90° Taping Orientation (Standard for NPIS29H)
- Termination Finish: F = Pb-free/RoHS Compliant (100%Sn)



Part Number	Standard Values - Case Size 62 (6.8 x 7.0 x 3.0)			
	Inductance Value (μH)	Test Conditions	DC Resistance (Ω)	DC Current Isat/Irms (Amps)
NPIS62H3R3MTRF	3.3 \pm 20%	100k, 0.3V	0.068	1.94
NPIS62H4R7MTRF	4.7 \pm 20%	100k, 0.3V	0.08	1.63
NPIS62H5R6MTRF	5.6 \pm 20%	100k, 0.3V	0.096	1.4
NPIS62H100MTRF	10 \pm 20%	1k, 0.3V	0.015	1.1
NPIS62H120MTRF	12 \pm 20%	1k, 0.3V	0.2	1
NPIS62H150MTRF	15 \pm 20%	1k, 0.3V	0.23	0.9
NPIS62H180MTRF	18 \pm 20%	1k, 0.3V	0.27	0.8
NPIS62H220MTRF	22 \pm 20%	1k, 0.3V	0.34	0.74
NPIS62H270MTRF	27 \pm 20%	1k, 0.3V	0.38	0.66
NPIS62H330MTRF	33 \pm 20%	1k, 0.3V	0.45	0.59
NPIS62H390MTRF	39 \pm 20%	1k, 0.3V	0.49	0.54
NPIS62H470MTRF	47 \pm 20%	1k, 0.3V	0.69	0.5
NPIS62H560MTRF	56 \pm 20%	1k, 0.3V	0.78	0.46
NPIS62H680MTRF	68 \pm 20%	1k, 0.3V	1.07	0.42
NPIS62H820MTRF	82 \pm 20%	1k, 0.3V	1.21	0.38
NPIS62H101MTRF	100 \pm 20%	1k, 0.3V	1.39	0.34
NPIS62H121MTRF	120 \pm 20%	1k, 0.3V	1.9	0.31
NPIS62H151MTRF	150 \pm 20%	1k, 0.3V	2.18	0.28
NPIS62H181MTRF	180 \pm 20%	1k, 0.3V	2.77	0.26
NPIS62H221MTRF	220 \pm 20%	1k, 0.3V	3.12	0.23
NPIS62H271MTRF	270 \pm 20%	1k, 0.3V	4.38	0.22
NPIS62H331MTRF	330 \pm 20%	1k, 0.3V	4.94	0.19

Irms/Isat specification is based on +40°C temperature rise or -25% inductance change whichever is less.



Part Number	Standard Values - Case Size 64 (6.8 x 7.0 x 5.0)			
	Inductance Value (μH)	Test Conditions	DC Resistance (Ω)	DC Current $I_{\text{sat}}/I_{\text{rms}}$ (Amps)
NPIS64H100MTRF	10 \pm 20%	1k, 0.3V	0.12	1.35
NPIS64H120MTRF	12 \pm 20%	1k, 0.3V	0.13	1.2
NPIS64H150MTRF	15 \pm 20%	1k, 0.3V	0.18	1.1
NPIS64H180MTRF	18 \pm 20%	1k, 0.3V	0.24	1
NPIS64H220MTRF	22 \pm 20%	1k, 0.3V	0.27	0.91
NPIS64H270MTRF	27 \pm 20%	1k, 0.3V	0.3	0.82
NPIS64H330MTRF	33 \pm 20%	1k, 0.3V	0.33	0.75
NPIS64H390MTRF	39 \pm 20%	1k, 0.3V	0.37	0.69
NPIS64H470MTRF	47 \pm 20%	1k, 0.3V	0.52	0.62
NPIS64H560MTRF	56 \pm 20%	1k, 0.3V	0.56	0.58
NPIS64H680MTRF	68 \pm 20%	1k, 0.3V	0.63	0.52
NPIS64H820MTRF	82 \pm 20%	1k, 0.3V	0.71	0.47
NPIS64H101MTRF	100 \pm 20%	1k, 0.3V	1.03	0.43
NPIS64H121MTRF	120 \pm 20%	1k, 0.3V	1.15	0.39
NPIS64H151MTRF	150 \pm 20%	1k, 0.3V	1.68	0.35
NPIS64H181MTRF	180 \pm 20%	1k, 0.3V	1.87	0.32
NPIS64H221MTRF	220 \pm 20%	1k, 0.3V	2.08	0.29
NPIS64H271MTRF	270 \pm 20%	1k, 0.3V	2.37	0.26
NPIS64H331MTRF	330 \pm 20%	1k, 0.3V	2.67	0.25
NPIS64H391MTRF	390 \pm 20%	1k, 0.3V	2.94	0.22
NPIS64H471MTRF	470 \pm 20%	1k, 0.3V	3.93	0.2
NPIS64H561MTRF	560 \pm 20%	1k, 0.3V	5.43	0.18
NPIS64H681MTRF	680 \pm 20%	1k, 0.3V	7.32	0.17
NPIS64H821MTRF	820 \pm 20%	1k, 0.3V	8.24	0.15
NPIS64H102MTRF	1000 \pm 20%	1k, 0.3V	9.26	0.14

$I_{\text{rms}}/I_{\text{sat}}$ specification is based on +40°C temperature rise or -25% inductance change whichever is less.



Part Number	Standard Values - Case Size 73 (7.8 x 7.8 x 4.0)			
	Inductance Value (μH)	Test Conditions	DC Resistance (Ω)	DC Current $I_{\text{sat}}/I_{\text{rms}}$ (Amps)
NPIS73H100MTRF	10 \pm 20%	1k, 0.3V	0.072	1.68
NPIS73H120MTRF	12 \pm 20%	1k, 0.3V	0.098	1.52
NPIS73H150MTRF	15 \pm 20%	1k, 0.3V	0.13	1.33
NPIS73H180MTRF	18 \pm 20%	1k, 0.3V	0.14	1.2
NPIS73H220MTRF	22 \pm 20%	1k, 0.3V	0.19	1.07
NPIS73H270MTRF	27 \pm 20%	1k, 0.3V	0.21	0.96
NPIS73H330MTRF	33 \pm 20%	1k, 0.3V	0.24	0.91
NPIS73H390MTRF	39 \pm 20%	1k, 0.3V	0.32	0.77
NPIS73H470MTRF	47 \pm 20%	1k, 0.3V	0.36	0.76
NPIS73H560MTRF	56 \pm 20%	1k, 0.3V	0.47	0.68
NPIS73H680MTRF	68 \pm 20%	1k, 0.3V	0.52	0.61
NPIS73H820MTRF	82 \pm 20%	1k, 0.3V	0.69	0.57
NPIS73H101MTRF	100 \pm 20%	1k, 0.3V	0.79	0.5
NPIS73H121MTRF	120 \pm 20%	1k, 0.3V	0.89	0.49
NPIS73H151MTRF	150 \pm 20%	1k, 0.3V	1.27	0.43
NPIS73H181MTRF	180 \pm 20%	1k, 0.3V	1.45	0.39
NPIS73H221MTRF	220 \pm 20%	1k, 0.3V	1.65	0.35
NPIS73H271MTRF	270 \pm 20%	1k, 0.3V	2.31	0.32
NPIS73H331MTRF	330 \pm 20%	1k, 0.3V	2.62	0.28
NPIS73H391MTRF	390 \pm 20%	1k, 0.3V	2.94	0.26
NPIS73H471MTRF	470 \pm 20%	1k, 0.3V	4.18	0.24
NPIS73H561MTRF	560 \pm 20%	1k, 0.3V	4.67	0.22
NPIS73H681MTRF	680 \pm 20%	1k, 0.3V	5.73	0.19
NPIS73H821MTRF	820 \pm 20%	1k, 0.3V	6.54	0.18
NPIS73H102MTRF	1000 \pm 20%	1k, 0.3V	9.44	0.16

$I_{\text{rms}}/I_{\text{sat}}$ specification is based on +40°C temperature rise or -25% inductance change whichever is less.



Part Number	Standard Values - Case Size 74 (7.8 x 7.8 x 5.0)			
	Inductance Value (μH)	Test Conditions	DC Resistance (Ω)	DC Current $I_{\text{sat}}/I_{\text{rms}}$ (Amps)
NPIS74H100MTRF	10 \pm 20%	1k, 0.3V	0.049	1.84
NPIS74H120MTRF	12 \pm 20%	1k, 0.3V	0.058	1.71
NPIS74H150MTRF	15 \pm 20%	1k, 0.3V	0.081	1.47
NPIS74H180MTRF	18 \pm 20%	1k, 0.3V	0.091	1.31
NPIS74H220MTRF	22 \pm 20%	1k, 0.3V	0.11	1.23
NPIS74H270MTRF	27 \pm 20%	1k, 0.3V	0.15	1.12
NPIS74H330MTRF	33 \pm 20%	1k, 0.3V	0.17	0.96
NPIS74H390MTRF	39 \pm 20%	1k, 0.3V	0.23	0.91
NPIS74H470MTRF	47 \pm 20%	1k, 0.3V	0.26	0.88
NPIS74H560MTRF	56 \pm 20%	1k, 0.3V	0.35	0.75
NPIS74H680MTRF	68 \pm 20%	1k, 0.3V	0.38	0.69
NPIS74H820MTRF	82 \pm 20%	1k, 0.3V	0.43	0.61
NPIS74H101MTRF	100 \pm 20%	1k, 0.3V	0.61	0.6
NPIS74H121MTRF	120 \pm 20%	1k, 0.3V	0.66	0.52
NPIS74H151MTRF	150 \pm 20%	1k, 0.3V	0.88	0.46
NPIS74H181MTRF	180 \pm 20%	1k, 0.3V	0.98	0.42
NPIS74H221MTRF	220 \pm 20%	1k, 0.3V	1.17	0.36
NPIS74H271MTRF	270 \pm 20%	1k, 0.3V	1.64	0.34
NPIS74H331MTRF	330 \pm 20%	1k, 0.3V	1.86	0.32
NPIS74H391MTRF	390 \pm 20%	1k, 0.3V	2.85	0.29
NPIS74H471MTRF	470 \pm 20%	1k, 0.3V	3.01	0.26
NPIS74H561MTRF	560 \pm 20%	1k, 0.3V	3.62	0.23
NPIS74H681MTRF	680 \pm 20%	1k, 0.3V	4.63	0.22
NPIS74H821MTRF	820 \pm 20%	1k, 0.3V	5.2	0.2
NPIS74H102MTRF	1000 \pm 20%	1k, 0.3V	6	0.18

$I_{\text{rms}}/I_{\text{sat}}$ specification is based on +40°C temperature rise or -25% inductance change whichever is less.



Part Number	Standard Values - Case Size 14 (10.5 x 10.5 x 5.0)			
	Inductance Value (μH)	Test Conditions	DC Resistance (Ω)	DC Current Isat/Irms (Amps)
NPIS14H4R7MTRF	4.7 \pm 20%	100k, 0.3V	0.035	3.2
NPIS14H6R8MTRF	6.8 \pm 20%	100k, 0.3V	0.044	2.8
NPIS14H100MTRF	10 \pm 20%	1k, 0.3V	0.05	2.4
NPIS14H120MTRF	12 \pm 20%	1k, 0.3V	0.054	2.25
NPIS14H150MTRF	15 \pm 20%	1k, 0.3V	0.061	2
NPIS14H180MTRF	18 \pm 20%	1k, 0.3V	0.084	1.8
NPIS14H220MTRF	22 \pm 20%	1k, 0.3V	0.094	1.65
NPIS14H270MTRF	27 \pm 20%	1k, 0.3V	0.11	1.45
NPIS14H330MTRF	33 \pm 20%	1k, 0.3V	0.15	1.35
NPIS14H390MTRF	39 \pm 20%	1k, 0.3V	0.17	1.2
NPIS14H470MTRF	47 \pm 20%	1k, 0.3V	0.21	1.1
NPIS14H560MTRF	56 \pm 20%	1k, 0.3V	0.23	1
NPIS14H680MTRF	68 \pm 20%	1k, 0.3V	0.26	0.93
NPIS14H820MTRF	82 \pm 20%	1k, 0.3V	0.36	0.84
NPIS14H101MTRF	100 \pm 20%	1k, 0.3V	0.41	0.76
NPIS14H151MTRF	150 \pm 20%	1k, 0.3V	0.64	0.63
NPIS14H181MTRF	180 \pm 20%	1k, 0.3V	0.84	0.57
NPIS14H221MTRF	220 \pm 20%	1k, 0.3V	0.96	0.52
NPIS14H271MTRF	270 \pm 20%	1k, 0.3V	1.07	0.47
NPIS14H331MTRF	330 \pm 20%	1k, 0.3V	1.37	0.43
NPIS14H391MTRF	390 \pm 20%	1k, 0.3V	1.55	0.39
NPIS14H471MTRF	470 \pm 20%	1k, 0.3V	1.74	0.36

Irms/Isat specification is based on +40°C temperature rise or -25% inductance change whichever is less.

Part Number	Standard Values - Case Size 24 (12.5 x 12.5 x 5.0)			
	Inductance Value (μ H)	Test Conditions	DC Resistance (Ω)	DC Current Isat/Irms (Amps)
NPIS24H1R0MTRF	1.0 \pm 20%	100k, 0.3V	0.010	8.0
NPIS24H2R2MTRF	2.2 \pm 20%	100k, 0.3V	0.014	4.9
NPIS24H3R3MTRF	3.3 \pm 20%	100k, 0.3V	0.015	4.5
NPIS24H4R7MTRF	4.7 \pm 20%	100k, 0.3V	0.018	5.7
NPIS24H5R6MTRF	5.6 \pm 20%	100k, 0.3V	0.020	5.2
NPIS24H6R8MTRF	6.8 \pm 20%	100k, 0.3V	0.023	4.9
NPIS24H8R2MTRF	8.2 \pm 20%	100k, 0.3V	0.026	4.6
NPIS24H100MTRF	10 \pm 20%	1k, 0.3V	0.028	4.5
NPIS24H120MTRF	12 \pm 20%	1k, 0.3V	0.038	4.0
NPIS24H150MTRF	15 \pm 20%	1k, 0.3V	0.050	3.2
NPIS24H180MTRF	18 \pm 20%	1k, 0.3V	0.057	3.1
NPIS24H220MTRF	22 \pm 20%	1k, 0.3V	0.066	2.9
NPIS24H270MTRF	27 \pm 20%	1k, 0.3V	0.080	2.8
NPIS24H330MTRF	33 \pm 20%	1k, 0.3V	0.097	2.7
NPIS24H390MTRF	39 \pm 20%	1k, 0.3V	0.132	2.1
NPIS24H470MTRF	47 \pm 20%	1k, 0.3V	0.16	1.9
NPIS24H560MTRF	56 \pm 20%	1k, 0.3V	0.19	1.8
NPIS24H680MTRF	68 \pm 20%	1k, 0.3V	0.22	1.5
NPIS24H820MTRF	82 \pm 20%	1k, 0.3V	0.26	1.3
NPIS24H101MTRF	100 \pm 20%	1k, 0.3V	0.31	1.2
NPIS24H121MTRF	120 \pm 20%	1k, 0.3V	0.38	1.1
NPIS24H151MTRF	150 \pm 20%	1k, 0.3V	0.53	0.95
NPIS24H181MTRF	180 \pm 20%	1k, 0.3V	0.62	0.85
NPIS24H221MTRF	220 \pm 20%	1k, 0.3V	0.70	0.80
NPIS24H271MTRF	270 \pm 20%	1k, 0.3V	0.87	0.60
NPIS24H331MTRF	330 \pm 20%	1k, 0.3V	0.99	0.50

Irms/Isat specification is based on +40°C temperature rise or -25% inductance change whichever is less.



Part Number	Standard Values - Case Size 25 (12.5 x 12.5 x 6.0)			
	Inductance Value (μH)	Test Conditions	DC Resistance (Ω)	DC Current $I_{\text{sat}}/I_{\text{rms}}$ (Amps)
NPIS25H1R0MTRF	1.0 \pm 20%	100k, 0.3V	0.01	8
NPIS25H2R2MTRF	2.2 \pm 20%	100k, 0.3V	0.014	7.8
NPIS25H3R3MTRF	3.3 \pm 20%	100k, 0.3V	0.014	8
NPIS25H8R2MTRF	8.2 \pm 20%	100k, 0.3V	0.021	4.4
NPIS25H100MTRF	10 \pm 20%	1k, 0.3V	0.025	4
NPIS25H120MTRF	12 \pm 20%	1k, 0.3V	0.027	3.5
NPIS25H150MTRF	15 \pm 20%	1k, 0.3V	0.03	3.3
NPIS25H180MTRF	18 \pm 20%	1k, 0.3V	0.034	3
NPIS25H220MTRF	22 \pm 20%	1k, 0.3V	0.036	2.8
NPIS25H270MTRF	27 \pm 20%	1k, 0.3V	0.051	2.3
NPIS25H330MTRF	33 \pm 20%	1k, 0.3V	0.057	2.1
NPIS25H390MTRF	39 \pm 20%	1k, 0.3V	0.068	2
NPIS25H470MTRF	47 \pm 20%	1k, 0.3V	0.075	1.8
NPIS25H560MTRF	56 \pm 20%	1k, 0.3V	0.11	1.7
NPIS25H680MTRF	68 \pm 20%	1k, 0.3V	0.12	1.5
NPIS25H820MTRF	82 \pm 20%	1k, 0.3V	0.14	1.4
NPIS25H101MTRF	100 \pm 20%	1k, 0.3V	0.16	1.3
NPIS25H121MTRF	120 \pm 20%	1k, 0.3V	0.17	1.1
NPIS25H151MTRF	150 \pm 20%	1k, 0.3V	0.23	1
NPIS25H181MTRF	180 \pm 20%	1k, 0.3V	0.29	0.9
NPIS25H221MTRF	220 \pm 20%	1k, 0.3V	0.4	0.8
NPIS25H271MTRF	270 \pm 20%	1k, 0.3V	0.46	0.75
NPIS25H331MTRF	330 \pm 20%	1k, 0.3V	0.51	0.68
NPIS25H391MTRF	390 \pm 20%	1k, 0.3V	0.69	0.65
NPIS25H471MTRF	470 \pm 20%	1k, 0.3V	0.77	0.58
NPIS25H561MTRF	560 \pm 20%	1k, 0.3V	0.86	0.54
NPIS25H681MTRF	680 \pm 20%	1k, 0.3V	1.2	0.48
NPIS25H821MTRF	820 \pm 20%	1k, 0.3V	1.34	0.43
NPIS25H102MTRF	1000 \pm 20%	1k, 0.3V	1.53	0.40

$I_{\text{rms}}/I_{\text{sat}}$ specification is based on +40°C temperature rise or -25% inductance change whichever is less.

Part Number	Standard Values - Case Size 27 (12.5 x 12.5 x 8.0)			
	Inductance Value (μ H)	Test Conditions	DC Resistance (Ω)	DC Current Isat/Irms (Amps)
NPIS27H1R0MTRF	1.0 \pm 20%	100k, 0.3V	0.006	12
NPIS27H1R2MTRF	1.2 \pm 20%	100k, 0.3V	0.008	8
NPIS27H2R2MTRF	2.2 \pm 20%	100k, 0.3V	0.0115	8
NPIS27H3R3MTRF	3.3 \pm 20%	100k, 0.3V	0.013	8
NPIS27H4R7MTRF	4.7 \pm 20%	100k, 0.3V	0.0158	6.8
NPIS27H6R8MTRF	6.8 \pm 20%	100k, 0.3V	0.019	6.6
NPIS27H8R2MTRF	8.2 \pm 20%	100k, 0.3V	0.02	5.6
NPIS27H100MTRF	10 \pm 20%	1k, 0.3V	0.0216	5.4
NPIS27H120MTRF	12 \pm 20%	1k, 0.3V	0.0243	4.9
NPIS27H150MTRF	15 \pm 20%	1k, 0.3V	0.027	4.5
NPIS27H180MTRF	18 \pm 20%	1k, 0.3V	0.0392	3.9
NPIS27H220MTRF	22 \pm 20%	1k, 0.3V	0.0432	3.6
NPIS27H270MTRF	27 \pm 20%	1k, 0.3V	0.0459	3.4
NPIS27H330MTRF	33 \pm 20%	1k, 0.3V	0.0648	3
NPIS27H390MTRF	39 \pm 20%	1k, 0.3V	0.0729	2.75
NPIS27H470MTRF	47 \pm 20%	1k, 0.3V	0.1	2.5
NPIS27H560MTRF	56 \pm 20%	1k, 0.3V	0.11	2.35
NPIS27H680MTRF	68 \pm 20%	1k, 0.3V	0.14	2.1
NPIS27H820MTRF	82 \pm 20%	1k, 0.3V	0.16	1.95
NPIS27H101MTRF	100 \pm 20%	1k, 0.3V	0.22	1.7
NPIS27H121MTRF	120 \pm 20%	1k, 0.3V	0.25	1.6
NPIS27H151MTRF	150 \pm 20%	1k, 0.3V	0.28	1.42
NPIS27H181MTRF	180 \pm 20%	1k, 0.3V	0.35	1.3
NPIS27H221MTRF	220 \pm 20%	1k, 0.3V	0.39	1.16
NPIS27H271MTRF	270 \pm 20%	1k, 0.3V	0.56	1.06
NPIS27H331MTRF	330 \pm 20%	1k, 0.3V	0.64	0.95
NPIS27H391MTRF	390 \pm 20%	1k, 0.3V	0.7	0.88
NPIS27H471MTRF	470 \pm 20%	1k, 0.3V	0.98	0.79
NPIS27H561MTRF	560 \pm 20%	1k, 0.3V	1.07	0.73
NPIS27H681MTRF	680 \pm 20%	1k, 0.3V	1.46	0.67
NPIS27H821MTRF	820 \pm 20%	1k, 0.3V	1.64	0.6
NPIS27H102MTRF	1000 \pm 20%	1k, 0.3V	1.82	0.55

Irms/Isat specification is based on +40°C temperature rise or -25% inductance change whichever is less.



Part Number	Standard Values - Case Size 29 (12.5 x 12.5 x 10.0)					
	Inductance Value (μH)	Tolerances (%)	Test Conditions	DC Resistance (Ω)	Isat (A)	Irms (A)
NPIS29H1R0YTRNF	1.0	30% (Y)	100k, 0.1V	5.5mΩ	19.9	11.6
NPIS29H1R8YTRNF	1.8	30% (Y)	100k, 0.1V	6.5mΩ	13.4	11
NPIS29H2R5YTRNF	2.5	30% (Y)	100k, 0.1V	8mΩ	12.16	10.3
NPIS29H3R5YTRNF	3.5	30% (Y)	100k, 0.1V	9.7mΩ	12	8.7
NPIS29H4R7YTRNF	4.7	30% (Y)	100k, 0.1V	11mΩ	11	8.4
NPIS29H5R8YTRNF	5.8	30% (Y)	100k, 0.1V	11.3mΩ	10.5	7.6
NPIS29H6R8_TRNF	6.8	30% (Y), 20% (M)	100k, 0.1V	11.5mΩ	10	7.1
NPIS29H7R5_TRNF	7.5	30% (Y), 20% (M)	100k, 0.1V	14mΩ	8.48	6.8
NPIS29H100_TRNF	10	30% (Y), 20% (M)	100k, 0.1V	17mΩ	8.2	6.95
NPIS29H120_TRNF	12	30% (Y), 20% (M)	100k, 0.1V	18.5mΩ	7.04	6.2
NPIS29H150_TRNF	15	30% (Y), 20% (M)	100k, 0.1V	25mΩ	5.8	5.22
NPIS29H220_TRNF	22	30% (Y), 20% (M)	100k, 0.1V	29mΩ	5.12	4.95
NPIS29H330_TRNF	33	30% (Y), 20% (M)	100k, 0.1V	53mΩ	4.25	3.6
NPIS29H470_TRNF	47	30% (Y), 20% (M)	100k, 0.1V	63mΩ	3.6	3.45
NPIS29H560_TRNF	56	30% (Y), 20% (M)	100k, 0.1V	68mΩ	2.85	2.95
NPIS29H680_TRNF	68	30% (Y), 20% (M)	100k, 0.1V	93mΩ	2.76	2.85
NPIS29H820_TRNF	82	30% (Y), 20% (M)	100k, 0.1V	99mΩ	2.62	2.6
NPIS29H101MTRNF	100	20% (M)	100k, 0.1V	0.126Ω	2.31	2.45
NPIS29H121MTRNF	120	20% (M)	100k, 0.1V	0.154Ω	2.05	2.2
NPIS29H151MTRNF	150	20% (M)	100k, 0.1V	0.174Ω	1.8	1.9
NPIS29H181MTRNF	180	20% (M)	100k, 0.1V	0.191Ω	1.66	1.86
NPIS29H221MTRNF	220	20% (M)	100k, 0.1V	0.246Ω	1.64	1.72
NPIS29H331MTRNF	330	20% (M)	100k, 0.1V	0.386Ω	1.28	1.28
NPIS29H471MTRNF	470	20% (M)	100k, 0.1V	0.471Ω	1.06	1.25
NPIS29H561MTRNF	560	20% (M)	100k, 0.1V	0.65Ω	1.01	0.98
NPIS29H681MTRNF	680	20% (M)	100k, 0.1V	0.73Ω	0.83	0.96
NPIS29H821MTRNF	820	20% (M)	100k, 0.1V	0.824Ω	0.81	0.94
NPIS29H102MTRNF	1000	20% (M)	100k, 0.1V	1.22Ω	0.7	0.78
NPIS29H122MTRNF	1200	20% (M)	100k, 0.1V	1.33Ω	0.64	0.79
NPIS29H152MTRNF	1500	20% (M)	100k, 0.1V	1.99Ω	0.56	0.58
NPIS29H182MTRNF	1800	20% (M)	100k, 0.1V	2.18Ω	0.48	0.54
NPIS29H222MTRNF	2200	20% (M)	100k, 0.1V	2.58Ω	0.43	0.52
NPIS29H332MTRNF	3300	20% (M)	100k, 0.1V	4.6Ω	0.3	0.4

Irms specification is based on +40°C temperature rise. Isat specification is based -25% inductance change.



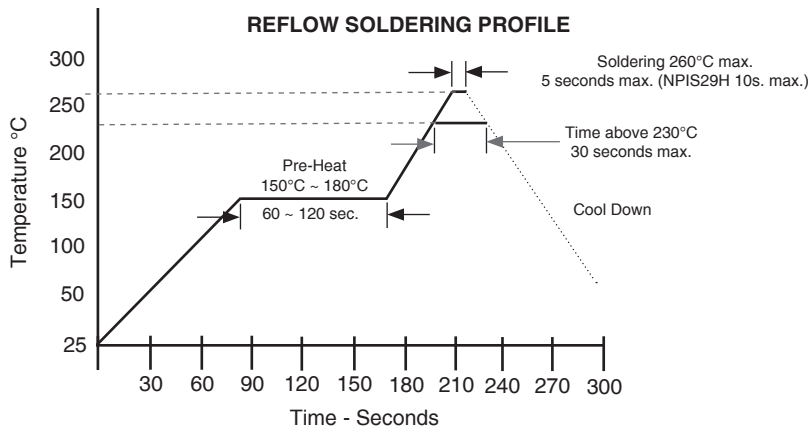

Case Size	TAPING DIMENSIONS (mm)					
	Ao	Bo	Ko	Co	W	Po
NPIS62H	7.0	6.6	3.2	7.5	16	12
NPIS64H	7.0	6.6	5.2	7.5	16	12
NPIS73H	7.6	7.6	4.2	7.5	16	12
NPIS74H			5.2			
NPIS14H	10.3	10.3	5.2	11.5	24	16
NPIS24H	12.9	12.9	4.9	11.5	24	16.0
NPIS25H			6.2			
NPIS27H			8.2			
NPIS29H	12.7 ± 0.1	12.7 ± 0.1	10.2 ± 0.1	11.5 ± 0.1	24 ± 0.2	24.0

STANDARD COMPONENT ORIENTATION ON TAPE (TRF) - (NPIS62H, 64H, 73H, 74H, 14H, 24H, 25H, & 27H)

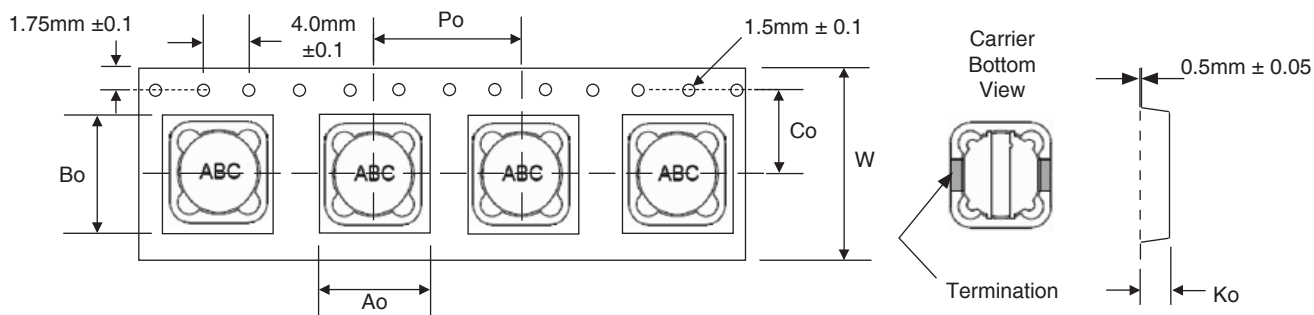

OPTIONAL COMPONENT ORIENTATION ON TAPE (TRNF) - Standard NPIS29H

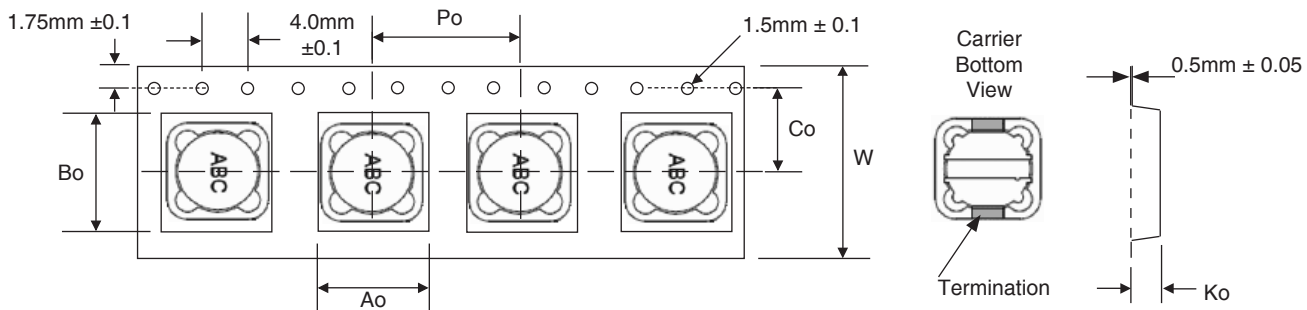

Tape Width	REEL DIMENSIONS (mm)			
	A(mm)	B(mm)	C(mm)	D(mm)
16mm	16.5 ± 0.5	100 ± 2.0	13 ± 0.5	330
24mm	24.5 ± 0.1	100 ± 2.0	13 ± 0.5	330

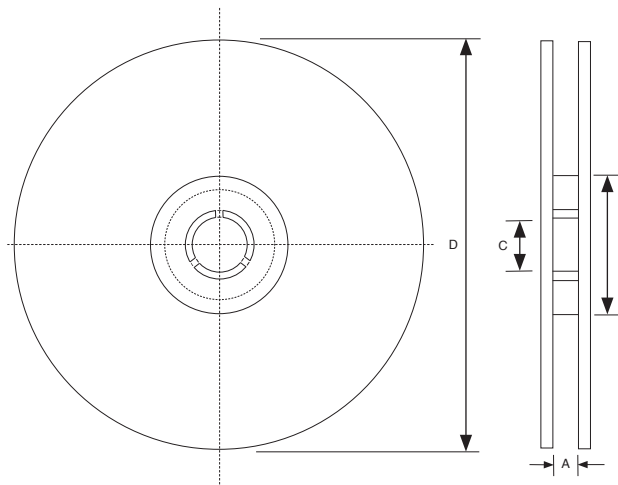

Size	REEL QUANTITY PER CASE SIZE								
	NPIS62H	NPIS64H	NPIS73H	NPIS74H	NPIS14H	NPIS24H	NPIS25H	NPIS27H	NPIS29H
Quantity per reel	1,500	1,000	1,000	1,000	1,000	600	600	400	250
Tape Width	16mm				24mm				