

# SMT POWER INDUCTORS

## Shielded Drum Core - PL93XX Series



- Height:** 0.157 inches (4.0mm) Max
- Footprint:** 0.410 inches x 0.410 inches (10.5mm x 10.5mm) Max
- Inductance Range:** 0.62μH to 278μH
- Current Rating:** up to 7.6A

### Electrical Specifications @ 25°C — Operating Temperature -55°C to +130°C

Part Numbers	Inductance @ Irated (μH TYP)	Irated <sup>2</sup> (A)	DCR (mΩ)		Inductance @ 0A <sub>DC</sub> (μH)	Saturation Current <sup>3</sup> (A) @25°C	Heating Current <sup>4</sup> (A)
			TYP	MAX			
PL9301	0.62	7.60	4.2	5.5	0.68±25%	10.00	7.60
PL9302	1.2	7.10	5.6	7.3	1.3±25%	8.00	7.10
PL9303	1.9	5.80	8.4	10.9	2.2±25%	6.15	5.80
PL9304	2.8	5.20	10.2	13.3	3.3±25%	5.80	5.20
PL9305	4.0	4.70	15.1	19.6	4.7±25%	5.40	4.70
PL9306	5.4	3.70	20.8	27.0	6.0±25%	4.50	3.70
PL9307	6.9	3.50	23.7	30.8	7.6±25%	4.00	3.50
PL9308	8.0	3.40	26.5	33.2	10±20%	3.80	3.40
PL9309	11	3.00	36.1	45.2	12±20%	3.40	3.00
PL9310	12	2.80	39.5	49.4	15±20%	3.10	2.80
PL9311	19	2.30	62	77	22±20%	2.80	2.30
PL9312	25	2.10	71	89	27±20%	2.30	2.10
PL9313	38	1.65	113	142	47±20%	2.10	1.65
PL9314	55	1.32	170	212	68±20%	1.50	1.32
PL9315	83	1.10	262	328	100±20%	1.35	1.10
PL9316	123	0.88	400	500	150±20%	1.15	0.88
PL9317	178	0.73	591	739	220±20%	0.92	0.73
PL9318	278	0.60	906	1133	330±20%	0.70	0.60

\*Inductance at 0A<sub>DC</sub> tolerance on indicated part numbers is ±30%; tolerance is ±20% on all other parts. Optional Tape & Reel packaging can be ordered by adding a "T" suffix to the part number (i.e. PL9301 becomes PL9301T). **NOTES FROM TABLE:** (See back page)

## Mechanical

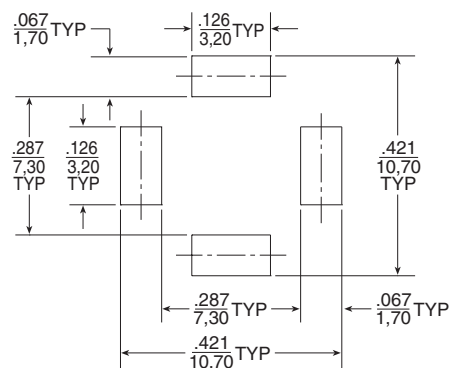
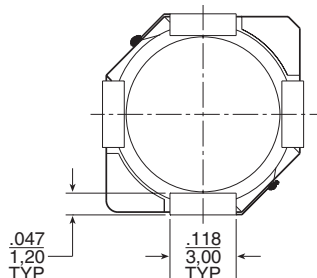
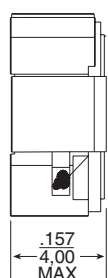
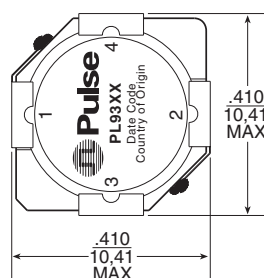

NOTE: Pin 3 and Pin 4 are for mechanical connection only.

## Schematic

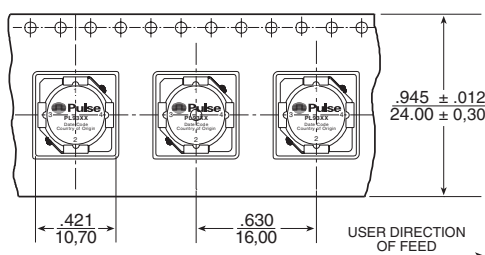
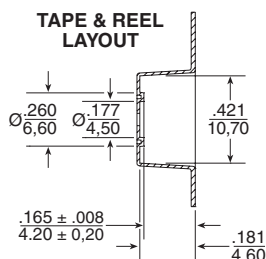
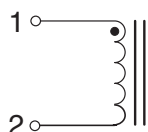

### SUGGESTED PAD LAYOUT

Weight . . . . . 2.5 grams  
Tape & Reel . . . . . 400/reel

Dimensions: Inches  
mm

Unless otherwise specified,  
all tolerances are ± .010  
0,25

# SMT POWER INDUCTORS

## Shielded Drum Core - PL93XX Series



### Notes from Tables

1. Temperature of the component (ambient plus temperature rise) must be within specified operating temperature range.
2. The rated current as listed is either the saturation current or the heating current depending on which value is lower.
3. The saturation current is the current which causes the inductance to drop to 75% of its initial inductance at zero bias. This current is determined by placing the component at room ambient (25°C), and applying a short duration pulse current (to eliminate self-heating effects) to the component.
4. The heating current is the DC current, which causes the temperature of the part to increase by approximately 40°C. This current is determined by extending the terminals of the component with 30mm length 28 gauge buss wires and applying the current to the device for 30 minutes. The temperature is measured by placing the thermocouple between the winding and the shield.
5. In high volt\*time applications, additional heating in the component can occur due to core losses in the inductor which may necessitate derating the current in order to limit the temperature rise of the component. In order to determine the approximate total loss (or temperature rise) for a given application, both copper losses and core losses should be taken into account.

### Inductance vs Current Characteristics

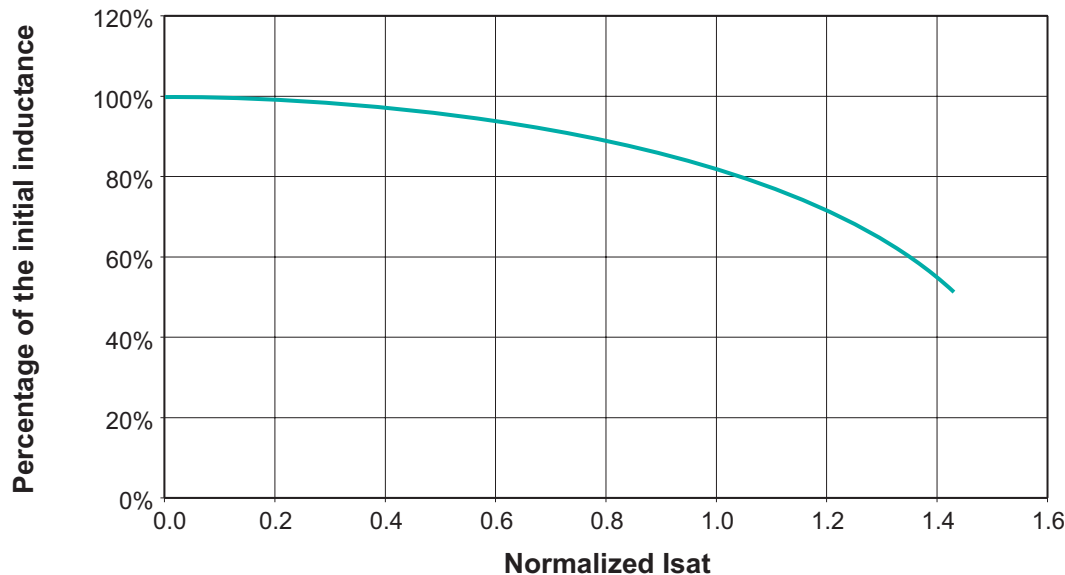

### For More Information:

**Pulse Worldwide Headquarters**  
2 Pearl Buck Court  
Bristol, PA 19007  
U.S.A.  
[www.pulseeng.com](http://www.pulseeng.com)

**Pulse Europe**  
Einsteinstrasse 1  
D-71083 Herrenberg  
Germany

**Pulse China Headquarters**  
B402, Shenzhen  
Tech-Innovation International  
Tenth Kejian Rd.  
High-Tech Industrial Park  
Nanshan District, Shenzhen  
China  
Tel: 86 755 33966678  
Fax: 86 755 33966700

**Pulse North China**  
Room 1503  
XinYin Building  
No. 888 YiShan Rd.  
Shanghai 200233  
China  
Tel: 86 21 54643211/2  
Fax: 86 21 54643210

**Pulse South Asia**  
150 Kampong Ampat  
#07-01/02  
KA Centre  
Singapore 368324  
Tel: 65 6287 8998  
Fax: 65 6280 0080

**Pulse North Asia**  
No. 26  
Kao Ching Rd.  
Yang Mei Chen  
Taoyuan Hsien  
Taiwan, R. O. C.  
Tel: 886 3 4641811  
Fax: 886 3 4641911

Tel: 215 781 6400  
Fax: 215 781 6403

Tel: 49 7032 7806 0  
Fax: 49 7032 7806 12

Performance warranty of products offered on this data sheet is limited to the parameters specified. Data is subject to change without notice. Other brand and product names mentioned herein may be trademarks or registered trademarks of their respective owners. © Copyright, 2007. Pulse Engineering, Inc. All rights reserved.