

GE730

N-CHANNEL ENHANCEMENT MODE POWER MOSFET

BVDSS	400V
RDS(ON)	1.0Ω
ID	5.5A

Description

The GE730 provide the designer with the best combination of fast switching, ruggedized device design, low on-resistance and cost-effectiveness.

The TO-220 is universally preferred for all commercial-industrial applications. The device is suited for switch mode power supplies, DC-AC converters and high current high speed switching circuits.

Features

- *Dynamic dv/dt Rating
- *Repetitive Avalanche Rated
- *Simple Drive Requirement
- *Fast Switching

Package Dimensions

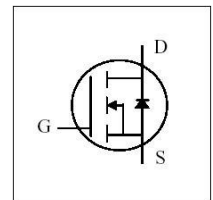
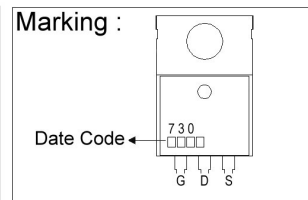
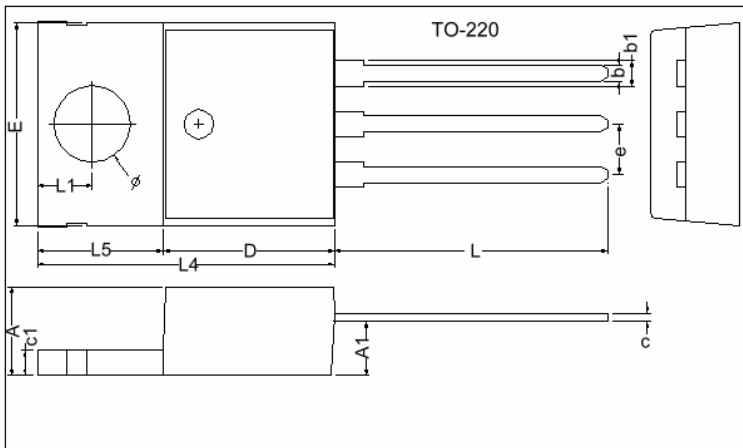

REF.	Millimeter		REF.	Millimeter	
	Min.	Max.		Min.	Max.
A	4.40	4.80	c1	1.25	1.45
b	0.76	1.00	b1	1.17	1.47
c	0.36	0.50	L	13.25	14.25
D	8.60	9.00	e	2.54 REF.	
E	9.80	10.4	L1	2.60	2.89
L4	14.7	15.3	∅	3.71	3.96
L5	6.20	6.60	A1	2.60	2.80

Absolute Maximum Ratings

Parameter	Symbol	Ratings	Unit
Drain-Source Voltage	V_{DS}	400	V
Gate-Source Voltage	V_{GS}	±30	V
Continuous Drain Current, $V_{GS}@10V$	$I_D @T_C=25^{\circ}C$	5.5	A
Continuous Drain Current, $V_{GS}@10V$	$I_D @T_C=100^{\circ}C$	3.5	A
Pulsed Drain Current ¹	I_{DM}	23	A
Total Power Dissipation	$P_D @T_C=25^{\circ}C$	74	W
Linear Derating Factor		0.59	W/°C
Single Pulse Avalanche Energy ²	E_{AS}	260	mJ
Avalanche Current	I_{AR}	5.5	A
Repetitive Avalanche Energy	E_{AR}	7	mJ
Operating Junction and Storage Temperature Range	T_j, T_{stg}	-55 ~ +150	°C

Thermal Data

Parameter	Symbol	Value	Unit
Thermal Resistance Junction-case Max.	Rthj-c	1.7	°C/W
Thermal Resistance Junction-ambient Max.	Rthj-a	62	°C/W

Electrical Characteristics(T_j = 25°C Unless otherwise specified)

Parameter	Symbol	Min.	Typ.	Max.	Unit	Test Conditions
Drain-Source Breakdown Voltage	BV _{DSS}	400	-	-	V	V _{GS} =0, I _D =1mA
Breakdown Voltage Temperature Coefficient	$\Delta BV_{DSS} / \Delta T_j$	-	0.36	-	V/°C	Reference to 25°C, I _D =1mA
Gate Threshold Voltage	V _{GS(th)}	2.0	-	4.0	V	V _{DS} =V _{GS} , I _D =250uA
Forward Transconductance	g _{fs}	-	30	-	S	V _{DS} =10V, I _D =2.75A
Gate-Source Leakage Current	I _{GSS}	-	-	±100	nA	V _{GS} = ±30V
Drain-Source Leakage Current(T _j =25°C)	I _{DSS}	-	-	10	uA	V _{DS} =400V, V _{GS} =0
Drain-Source Leakage Current(T _j =150°C)		-	-	100	uA	V _{DS} =320V, V _{GS} =0
Static Drain-Source On-Resistance	R _{DS(ON)}	-	-	1	Ω	V _{GS} =10V, I _D =2.75A
Total Gate Charge ³	Q _g	-	35	-	nC	I _D =5.5A V _{DS} =320V V _{GS} =10V
Gate-Source Charge	Q _{gs}	-	3.7	-		
Gate-Drain ("Miller") Change	Q _{gd}	-	20	-		
Turn-on Delay Time ³	T _{d(on)}	-	8	-	ns	V _{DD} =200V I _D =5.5A V _{GS} =10V R _G =10Ω R _D =36Ω
Rise Time	T _r	-	20	-		
Turn-off Delay Time	T _{d(off)}	-	47	-		
Fall Time	T _f	-	18	-		
Input Capacitance	C _{iss}	-	565	-	pF	V _{GS} =0V V _{DS} =25V f=1.0MHz
Output Capacitance	C _{oss}	-	70	-		
Reverse Transfer Capacitance	C _{rss}	-	38	-		

Source-Drain Diode

Parameter	Symbol	Min.	Typ.	Max.	Unit	Test Conditions
Forward On Voltage ³	V _{SD}	-	-	1.5	V	I _S =5.5A, V _{GS} =0V, T _j =25°C
Continuous Source Current (Body Diode)	I _S	-	-	5.5	A	V _D =V _G =0V, V _S =1.5V
Pulsed Source Current (Body Diode) ¹	I _{SM}	-	-	23	A	

Notes: 1. Pulse width limited by safe operating area.

2. Staring T_j=25°C, V_{DD}=50V, L=15mH, R_G=25Ω, I_{AS}=5.5A.

3. Pulse width ≤ 300us, duty cycle ≤ 2%.

Characteristics Curve

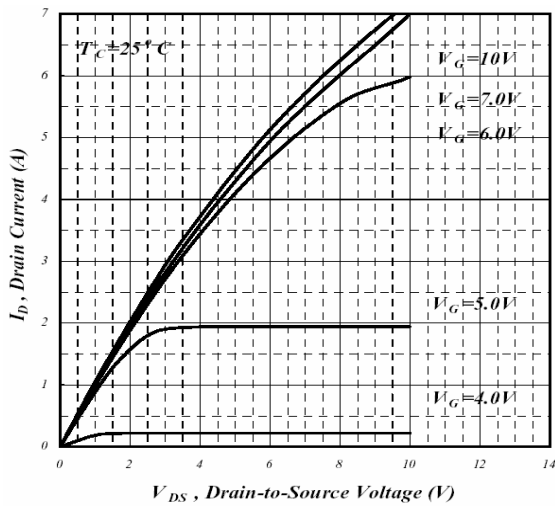

Fig 1. Typical Output Characteristics

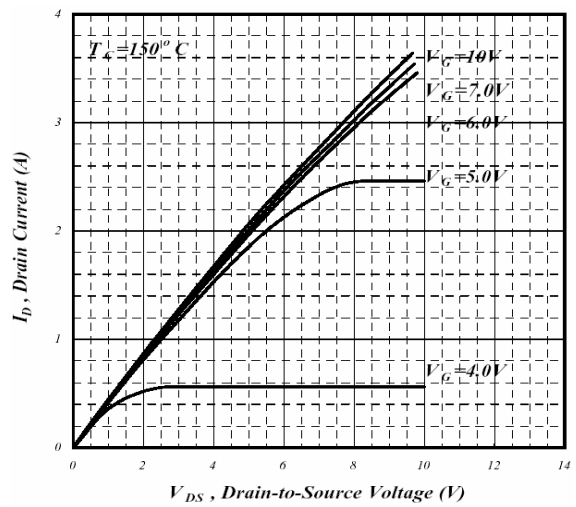

Fig 2. Typical Output Characteristics

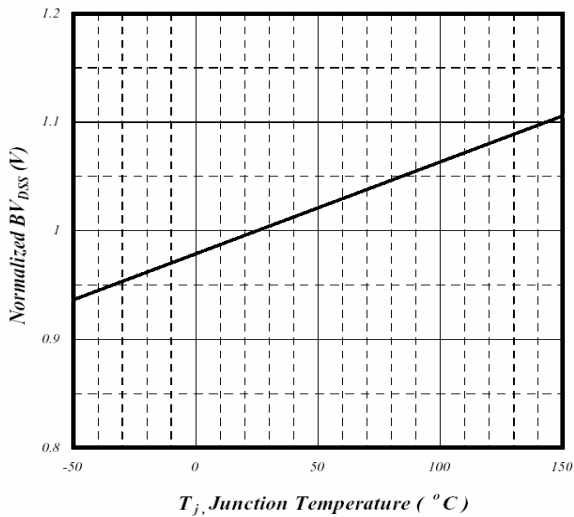

Fig 3. Normalized BV_{DSS} v.s. Junction Temperature

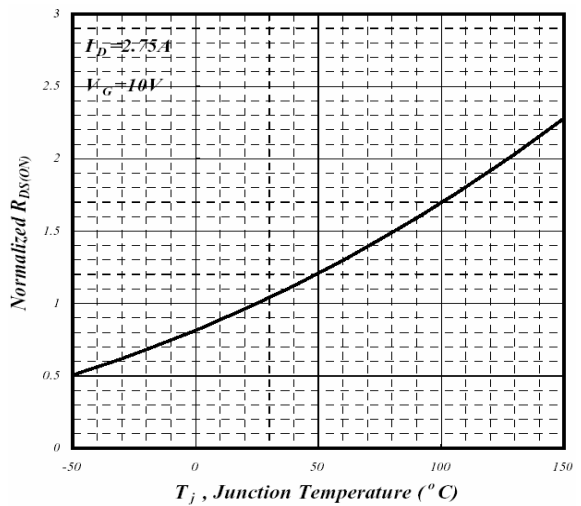

Fig 4. Normalized On-Resistance v.s. Junction Temperature

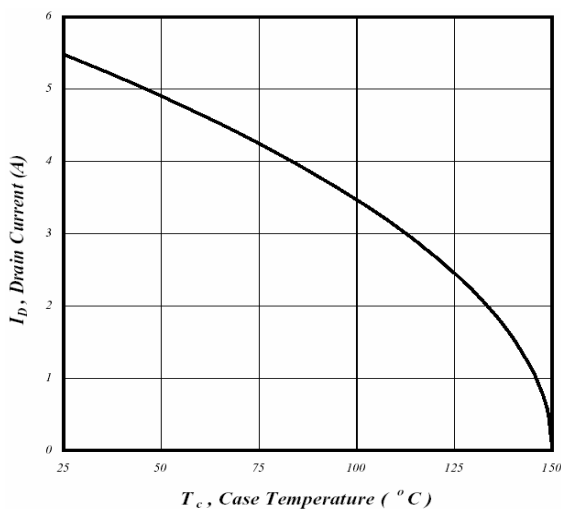

Fig 5. Maximum Drain Current v.s. Case Temperature

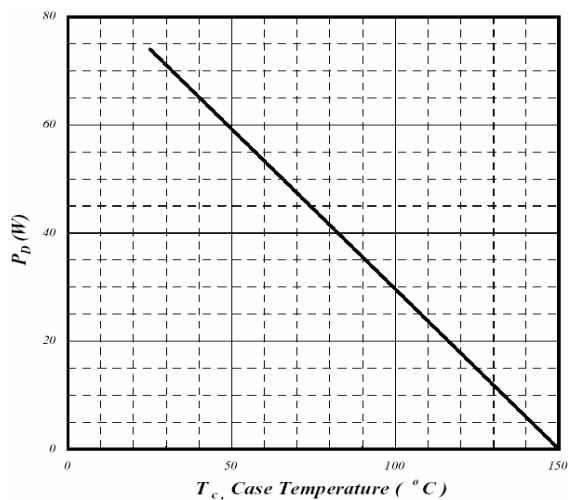

Fig 6. Type Power Dissipation

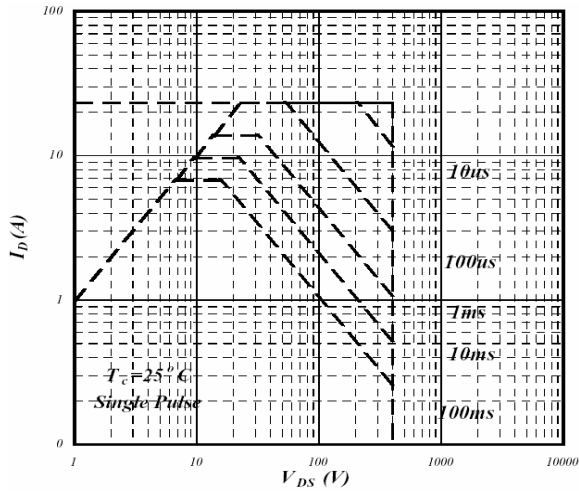

Fig 7. Maximum Safe Operating Area

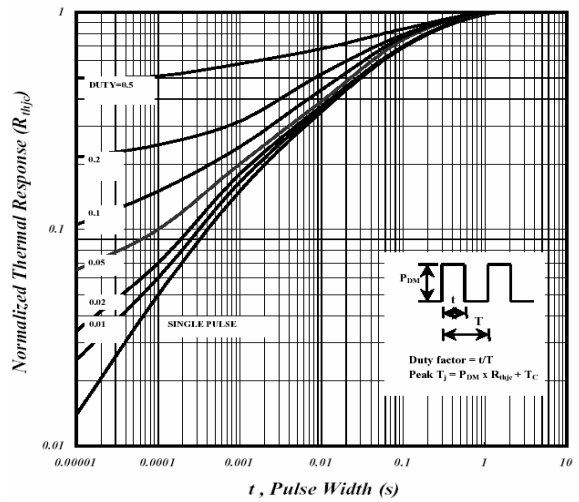

Fig 8. Effective Transient Thermal Impedance

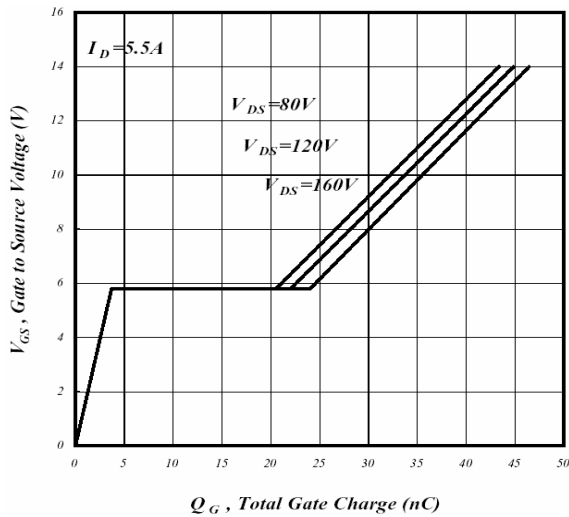

Fig 9. Gate Charge Characteristics

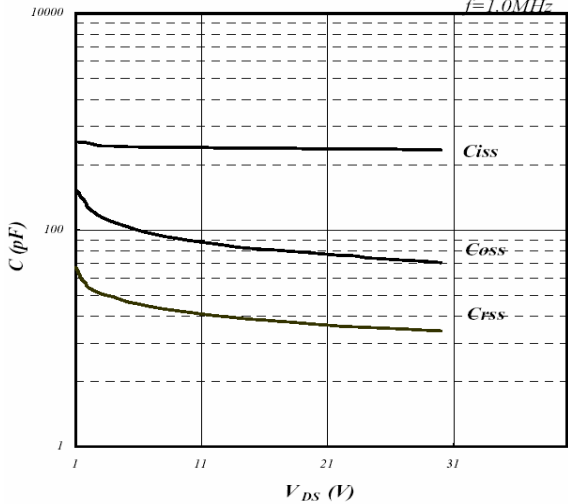

Fig 10. Typical Capacitance Characteristics

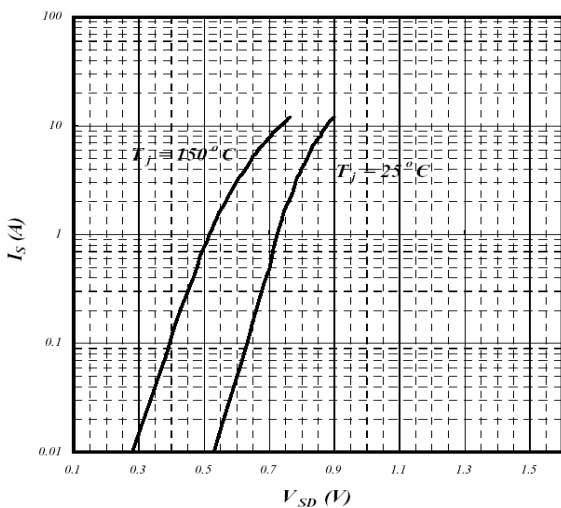

Fig 11. Forward Characteristics of Reverse Diode

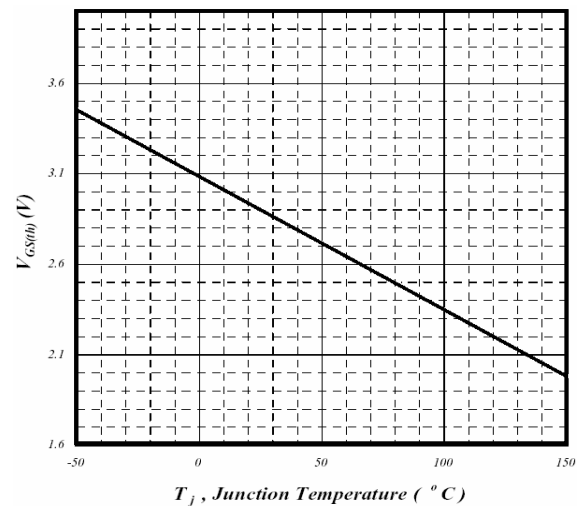

Fig 12. Gate Threshold Voltage v.s. Junction Temperature

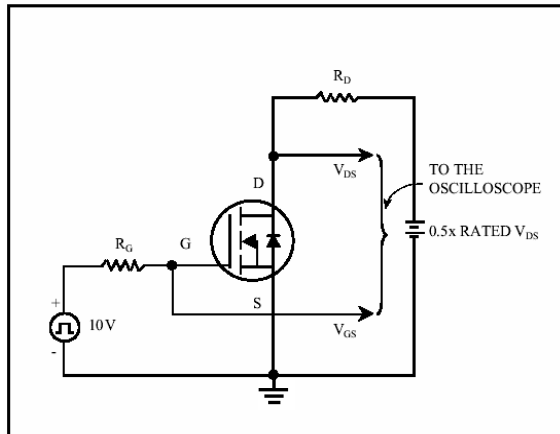

Fig 13. Switching Time Circuit

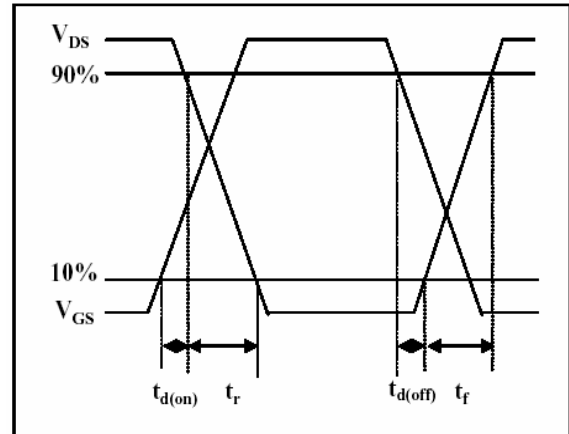

Fig 14. Switching Time Waveform

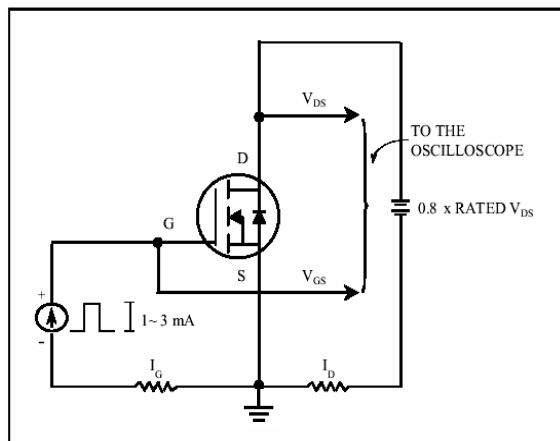

Fig 15. Gate Charge Circuit

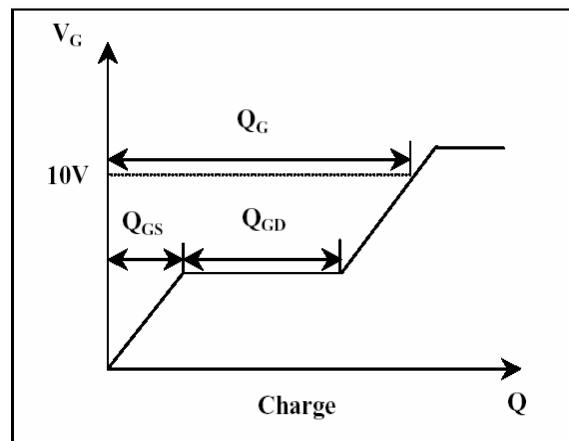

Fig 16. Gate Charge Waveform

Important Notice:

- All rights are reserved. Reproduction in whole or in part is prohibited without the prior written approval of GTM.
- GTM reserves the right to make changes to its products without notice.
- GTM semiconductor products are not warranted to be suitable for use in life-support Applications, or systems.
- GTM assumes no liability for any consequence of customer product design, infringement of patents, or application assistance.

Head Office And Factory:

- **Taiwan:** No. 17-1 Tatung Rd. Fu Kou Hsin-Chu Industrial Park, Hsin-Chu, Taiwan, R. O. C.
- TEL : 886-3-597-7061 FAX : 886-3-597-9220, 597-0785
- **China:** (201203) No.255, Jang-Jiang Tsai-Lueng RD. , Pu-Dung-Hsin District, Shang-Hai City, China
- TEL : 86-21-5895-7671 ~ 4 FAX : 86-21-38950165