

T.41-05

ML4016N, ML4016C, ML4016R ML4406, ML4446N

TYPE
NAME

DESCRIPTION

Mitsubishi ML4XX6 are AlGaAs laser diodes emitting light beams around 780nm wavelength. They lase by applying forward current exceeding threshold values, and emit light power of about 3mW/facet at an operating current of around 10mA in excess of the threshold current. They operate, under CW or pulse conditions according to input current, at case temperatures up to 60°C.

ML4XX6 are hermetically sealed devices having a Si photodiode for monitoring the light output. Output current of the photodiode can be used for automatic control of the operating currents or case temperatures of the lasers. They are well suited for optical information systems and other optical systems.

FEATURES

- Si photodiode is installed in the laser package
- High reliability, long operation life
- Low optical noise (High S/N)
- Multi-mode oscillation

APPLICATION

Video disk-players, CD-ROM

ABSOLUTE MAXIMUM RATINGS

Symbol	Parameter	Conditions	Ratings	Unit
P _O	Light output	CW	5	mW
		Pulse (Note 1)	6	
V _{RL}	Reverse voltage (Laser diode)	—	2	V
V _{RD}	Reverse voltage (Photodiode)	—	15	V
I _{FD}	Forward current (Photodiode)	—	10	mA
T _C	Case temperature	—	-40~+60	°C
T _{stg}	Storage temperature	—	-55~+100	°C

Note 1 : Duty less than 50%, pulse width less than 1μs.

ELECTRICAL/OPTICAL CHARACTERISTICS (T_C=25°C)

Symbol	Parameter	Test conditions	Limits			Unit
			Min.	Typ.	Max.	
I _{th}	Threshold current	CW	—	45	70	mA
I _{OP}	Operating current	CW, P _O =3mW	—	55	80	mA
V _{OP}	Operating voltage (Laser diode)	CW, P _O =3mW	—	1.8	2.5	V
P _O	Light output	CW, I _F =I _{th} +10mA	—	3	—	mW
λ _F	Lasing wavelength	CW, P _O =3mW	765	780	795	nm
θ	Full angle at half maximum	CW, P _O =3mW	9	11	17	deg.
θ _⊥			20	38	48	deg.
I _m	Monitoring output current	CW, P _O =3mW V _{RD} =1V R _L =10Ω (Note 2)	0, 15	0.35	0.7	mA
I _D	Dark current (Photodiode)	V _{RD} =10V	—	—	0.5	μA
C _t	Capacitance (Photodiode)	V _B =0V, f=1MHz	—	7	—	pF

Note 2 : R_L is load resistance of the photodiode.

T-41-05

OUTLINE DRAWINGS

ML4016N/
ML4016C/
ML4016R

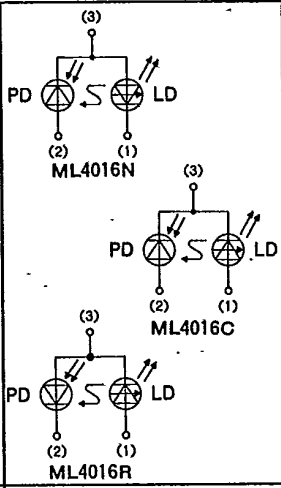
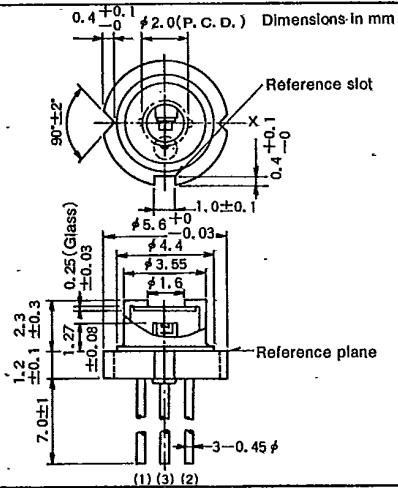
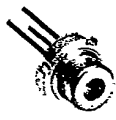

ML4406

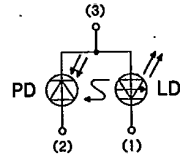
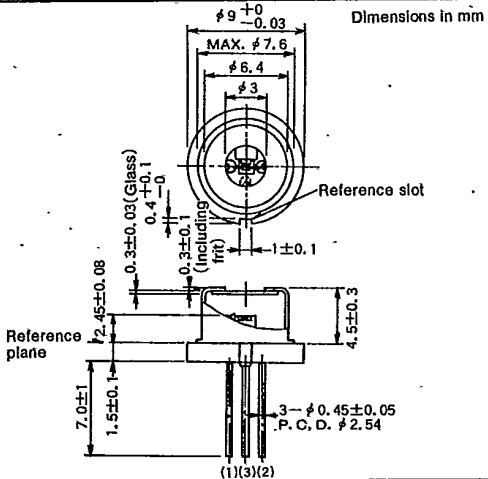
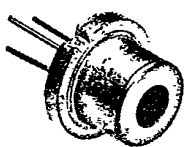

ML4446N

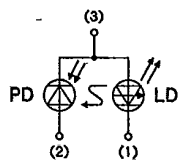
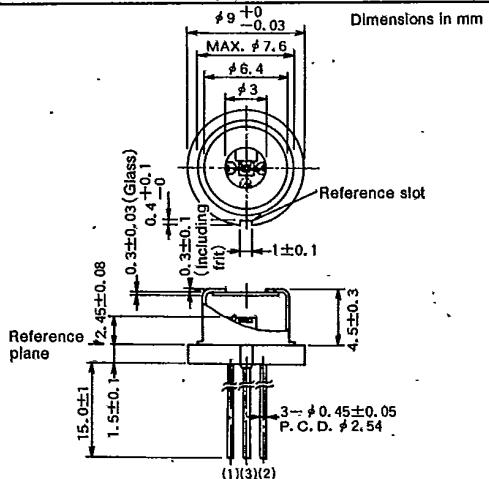
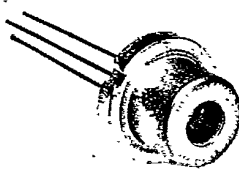

1 Light output vs. forward current

Typical light output vs. forward current characteristics are shown in Fig. 1. The threshold current for lasing is typically 45mA at room temperature. Above the threshold, the light output increases linearly with current, and no kinks are observed in the curves. As can be seen in Fig. 1, the threshold current and slope efficiency (dP_o/dI_f) depend on case temperature of the lasers. This suggests that automatic control of temperature or current is necessary to keep the light output constant since temperature variation is inevitable in practical systems. The automatic controls should be such that the maximum ratings for the light output and the case temperature are not exceeded. "OPERATING CONSIDERATIONS" gives an example of an automatic light output control circuit.

2 Temperature dependence of threshold current (I_{th})

A typical temperature dependence of the threshold current is shown in Fig. 2. The characteristic temperature T_0 of the threshold current is typically 130K in $T_c \leq 60^\circ\text{C}$, where the definition of T_0 is $I_{th} \propto \exp(T_c/T_0)$

3 Temperature dependence of slope efficiency (η_o)

A typical temperature dependence of the slope efficiency η_o is shown in Fig. 3. The gradient is about $0\text{mW/mA}^\circ\text{C}$.

Fig. 1 Light output vs. forward current

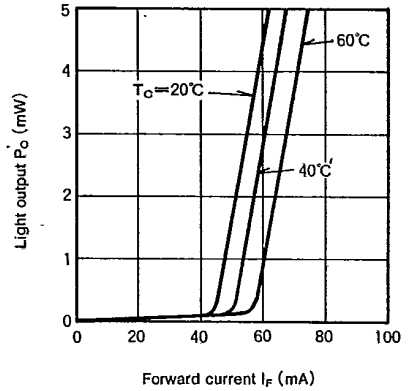

Fig. 2 Temperature dependence of threshold current

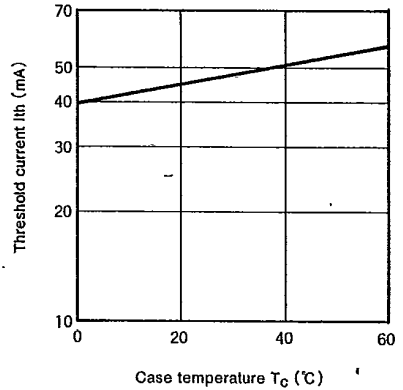
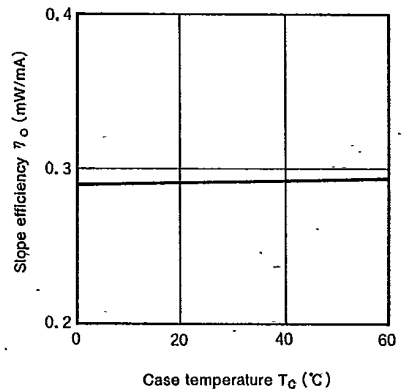

Fig. 3 Temperature dependence of slope efficiency



4 Forward current vs. voltage

Typical forward current vs. voltage characteristics are shown in Fig. 4. In general, as the case temperature rises, the forward voltage V_F decreases slightly against the constant current I_F . V_F varies typically at a rate of $-2.0\text{mV}/^\circ\text{C}$ at $I_F = 1\text{mA}$.

Fig. 4 Forward current vs. voltage characteristics

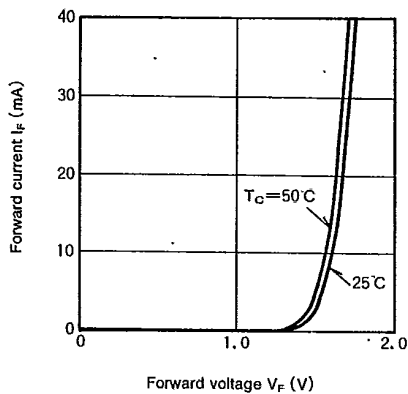

5 Emission spectra

Typical emission spectra under CW operation are shown in Fig. 5. In general, at an output of 3mW, multi mode is observed. The peak wavelength depends on the operating case temperature and forward current (output level).

Fig. 5 Emission spectra under CW operation

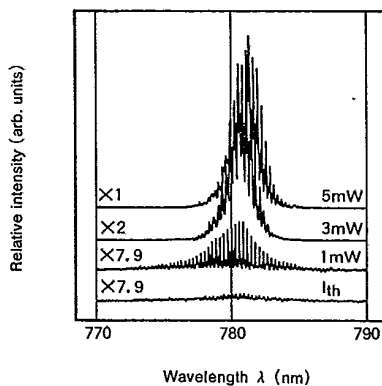

6 Temperature dependence of peak wavelength

A typical temperature dependence of the peak wavelength at an output of 3mW is shown in Fig. 6.

The peak wavelength of the beam shifts to adjacent longitudinal mode by variation of operating temperature. Averaged temperature coefficient is about $0.26\text{nm}/^\circ\text{C}$.

Fig. 6 Temperature dependence of peak wavelength

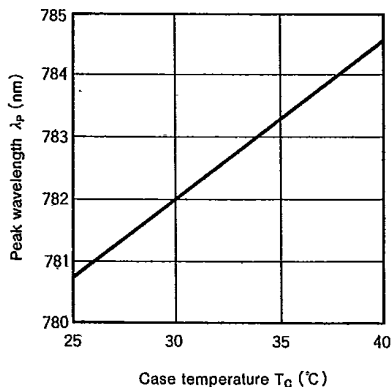

7 Far-field radiation pattern

The ML4XX6 laser diodes lase in fundamental transverse (TE_{00}) mode and the mode does not change with the current. They have a typical emitting area (size of near-field pattern) of $2.1 \times 0.6 \mu\text{m}^2$. Fig. 7 and Fig. 8 show typical far-field radiation patterns in "parallel" and "perpendicular" planes.

The full angles at half maximum points (FAHM) are typically 11° and 38° .

Fig. 7 Far-field patterns in plane parallel to heterojunctions

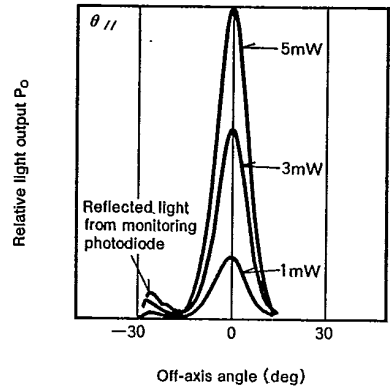
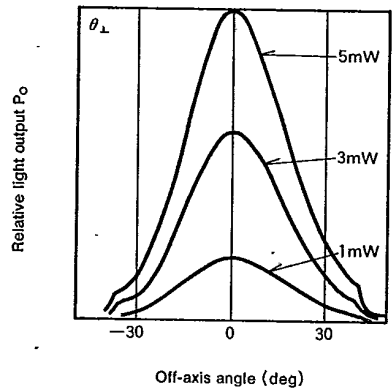

Fig. 8 Far-field patterns in plane perpendicular to heterojunctions



8 Monitoring output

The laser diodes emit beams from both of their mirror surfaces, front and rear surfaces (see the outline drawing). The rear beam can be used for monitoring power of front beam since the rear beam is proportional to the front one. In the case of ML4XX6 lasers, the rear beam powers are changed into photocurrent by the monitoring photodiodes. Fig. 9 shows an example of light output vs. monitoring photocurrent characteristics. Above the threshold current, the monitored photocurrent linearly increases with the light output.

Fig. 9 Light output vs. monitoring output current

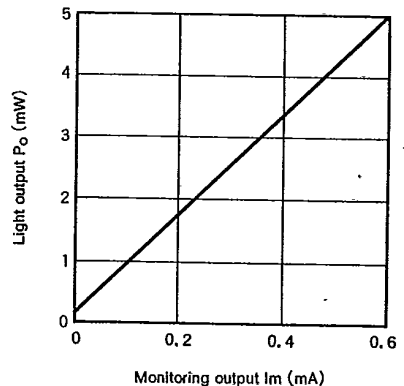
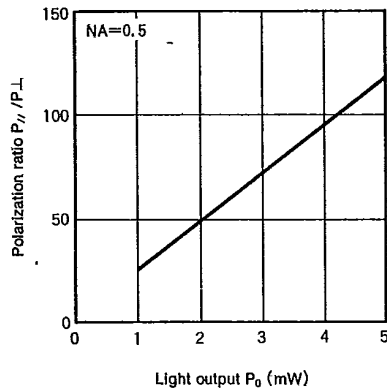

Fig. 10 Polarization ratio vs. light output

9 Polarization ratio

The polarization ratio ($P_{//}/P_{\perp}$), which is the ratio of the parallel polarized light output and the perpendicular polarized one, vs. total light output characteristics is shown in Fig. 10. The polarization ratio linearly increases with the light power.



10 S/N vs optical feedback ratio

S/N vs optical feedback ratio, where the frequency is 20kHz and the bandwidth is 300Hz is shown in Fig. 11.

That where the frequency is 10MHz and the bandwidth is 300kHz is shown in Fig. 12.

Fig. 11 S/N vs. optical feedback ratio

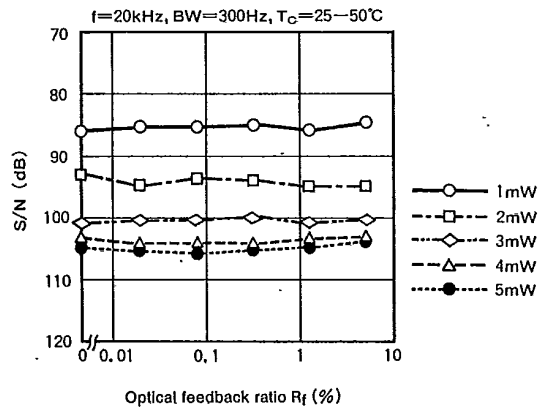
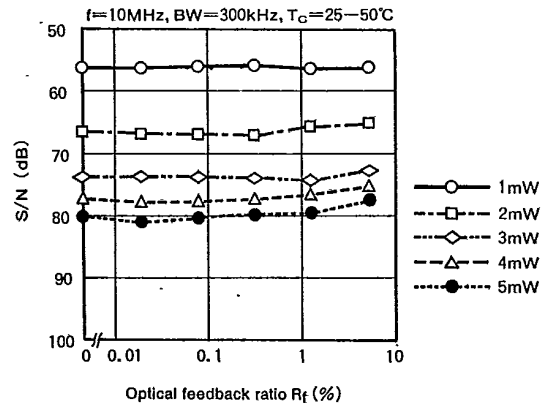

Fig. 12 S/N vs. optical feedback ratio



11 Astigmatic focal distance

There seems to be a difference in luminous point in the parallel and perpendicular direction with the laser beam. This distance between the two points is astigmatic focal distance. Therefore, when the laser beam is focused, there is a difference in focal point in the two directions.

The typical astigmatic focal distance at $NA=0.7$ of ML4XX6 is shown in Fig. 13.

Fig. 13 Astigmatic focal distance

