

Type 500C 95 °C Long-Life, Screw Terminal, Aluminum Electrolytic

–40 °C to +95 °C, Long Life

Twice the Life!

Type 500C capacitors are designed for mainframe computers and other long life UPS and power supply filter applications. They deliver nearly as much capacitance as the Type DCMC capacitors, but with two times the life expectancy. They are an excellent choice for high ripple applications. The extended cathode foil of the 500C assures cool operation with heat flow from the capacitor element to the can.



Highlights

- Long-life, High-Capacitance
- Better for Power-supply and UPS systems
- Thermal-Pak™ extended cathode construction

Specifications

Operating Temperature:	–40 °C to +95 °C
Rated Voltage:	6.3 to 500 Vdc
Capacitance:	100 μF to 2.6 F
Capacitance Tolerance:	<200 Vdc: –10 +75%; ≥200 Vdc: –10% +50%
Leakage Current:	≤3√CV μA at 5 minutes; 4 mA max.
Cold Impedance:	20 °C multiple of 25 °C Z ≤20 for 6.3–10 V, 8 for 16–50 V, 4 for 63–100 V, 3 for 150 V and up.
Ripple Current Multipliers:	Ambient Temperature

45 °C	55 °C	65 °C	75 °C	85 °C
2.00	1.82	1.59	1.33	1.00

Frequency

	50 Hz	60 Hz	120 Hz	360 Hz	1 kHz	5 kHz	10 kHz & up
1 3/8" & 1 3/4" Diameters							
6.3 to 160 V	0.91	0.93	1.00	1.06	1.08	1.10	1.10
200 to 350 V	0.76	0.81	1.00	1.24	1.36	1.43	1.44
400 to 500 Vx	0.76	0.81	1.00	1.24	1.37	1.44	1.45
2" & 2 1/2" Diameters							
6.3 to 160 V	0.93	0.95	1.00	1.04	1.06	1.06	1.07
200 to 350 V	0.78	0.83	1.00	1.20	1.29	1.34	1.35
400 to 500 V	0.77	0.82	1.00	1.22	1.33	1.39	1.40
3" & 3 1/2" Diameters							
6.3 to 160 V	0.95	0.97	1.00	1.03	1.04	1.04	1.04
200 to 350 V	0.84	0.88	1.00	1.12	1.17	1.20	1.20
400 to 500 V	0.79	0.84	1.00	1.18	1.26	1.31	1.32



Complies with the EU Directive 2002/95/EC requirement restricting the use of Lead (Pb), Mercury (Hg), Cadmium (Cd), Hexavalent chromium (Cr(VI)), PolyBrominated Biphenyls (PBB) and PolyBrominated Diphenyl Ethers (PBDE).

EIA Ripple Life: 5,000 h at full load @ +85 °C per EIA IS-749

ΔCapacitance ±20%
ESR 200% of limit
DCL 100% of limit

Life Test: 5,000 h at 95 °C and rated voltage

ΔCapacitance ±20%
ESR 200% of limit
DCL 100% of limit

Shelf Life: 500 h @ +95 °C, Capacitance, ESR and DCL, initial requirements.

Vibration: 10 to 55 Hz, 0.06" and 10 g max, 1.5 h ea. of 2 axis

Type 500C 95 °C Long-Life, Screw Terminal, Aluminum Electrolytic

Outline Drawings

Case Dimensions Uninsulated Case Dimensions

For insulated case, add 0.024”(0.610 mm) to “D”and 0.030”(0.762 mm) to height.

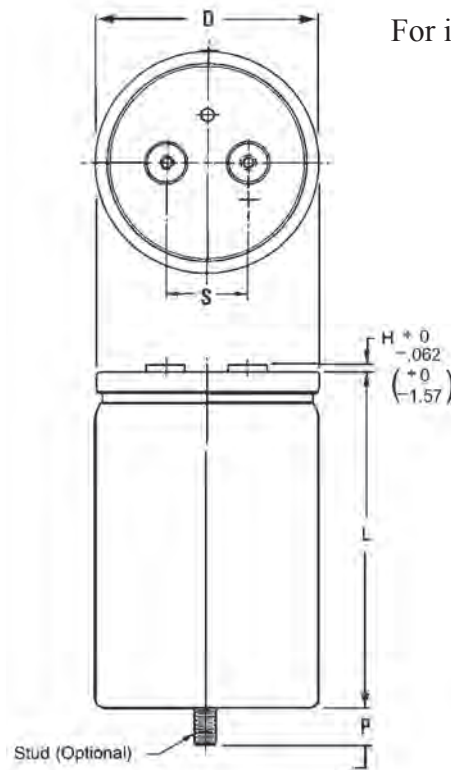

NOTE: With the stud-mount feature, a thermally-conductive disk can be inserted in the bottom flush with the outer insulating sleeve. This reduces the thermal resistance through the can bottom by 0.3 °C/W. Can Style P.

Case Code	Diam. (D)		Length (L)		Terminals (S)		Typical Weight	
	±.031 Inches	±.78 mm	±.062 Inches	±1.57 mm	±0.015 Inches	±.38 mm	oz	g
AK	1.375	34.93	1.625	41.28	0.50	12.70	1.9	54
AA	1.375	34.93	2.125	53.98	0.50	12.70	2.0	57
AH	1.375	34.93	2.625	66.68	0.50	12.70	2.7	77
AB	1.375	34.93	3.125	79.38	0.50	12.70	3.3	94
AJ	1.375	34.93	3.625	92.08	0.50	12.70	3.8	108
AC	1.375	34.93	4.125	104.78	0.50	12.70	4.4	125
AD	1.375	34.93	4.625	117.48	0.50	12.70	5.1	145
AE	1.375	34.93	5.125	130.18	0.50	12.70	6.8	193
AF	1.375	34.93	5.625	142.88	0.50	12.70	8.1	230
EA	1.750	44.45	2.125	53.98	0.75	19.05	2.7	76
EH	1.750	44.45	2.625	66.68	0.75	19.05	3.8	108
EB	1.750	44.45	3.125	79.38	0.75	19.05	5.1	145
EJ	1.750	44.45	3.625	92.08	0.75	19.05	6.8	193
EC	1.750	44.45	4.125	104.78	0.75	19.05	8.1	230
ED	1.750	44.45	4.625	117.48	0.75	19.05	9.0	255
EE	1.750	44.45	5.125	130.18	0.75	19.05	9.5	269
EF	1.750	44.45	5.625	142.88	0.75	19.05	10.5	298
BA	2.000	50.80	2.125	53.98	0.88	22.23	5.4	153
BH	2.000	50.80	2.625	66.68	0.88	22.23	6.1	173
BB	2.000	50.80	3.125	79.38	0.88	22.23	6.8	193
BJ	2.000	50.80	3.625	92.08	0.88	22.23	8.2	232
BC	2.000	50.80	4.125	104.78	0.88	22.23	9.5	269
BD	2.000	50.80	4.625	117.48	0.88	22.23	10.3	292
BE	2.000	50.80	5.125	130.18	0.88	22.23	10.7	303
BF	2.000	50.80	5.625	142.88	0.88	22.23	13.0	369
CH	2.500	63.50	2.625	66.68	1.13	28.58	9.2	261
CB	2.500	63.50	3.125	79.38	1.13	28.58	10.4	295
CJ	2.500	63.50	3.625	92.08	1.13	28.58	12.7	361
CC	2.500	63.50	4.125	104.78	1.13	28.58	15.0	425
CD	2.500	63.50	4.625	117.48	1.13	28.58	17.2	488
CE	2.500	63.50	5.125	130.18	1.13	28.58	19.3	547
CF	2.500	63.50	5.625	142.88	1.13	28.58	21.4	607
DB	3.000	76.20	3.125	79.38	1.25	31.75	16.7	473
DJ	3.000	76.20	3.625	92.08	1.25	31.75	20.0	567
DC	3.000	76.20	4.125	104.78	1.25	31.75	22.2	629
DD	3.000	76.20	4.625	117.48	1.25	31.75	25.5	723
DE	3.000	76.20	5.125	130.18	1.25	31.75	30.0	850
DF	3.000	76.20	5.625	142.88	1.25	31.75	31.9	904
DP	3.000	76.20	5.875	149.23	1.25	31.75	32.8	931
DN	3.000	76.20	7.625	193.68	1.25	31.75	39.5	1119
DG	3.000	76.20	8.625	219.08	1.25	31.75	43.3	1227
FC	3.500	88.90	4.125	104.78	1.25	31.75	30.0	850
FD	3.500	88.90	4.625	117.48	1.25	31.75	34.4	976
FE	3.500	88.90	5.125	130.18	1.25	31.75	40.5	1148
FF	3.500	88.90	5.625	142.88	1.25	31.75	43.1	1221
FP	3.500	88.90	5.875	149.23	1.25	31.75	44.3	1257
FN	3.500	88.90	7.625	193.68	1.25	31.75	53.3	1512
FG	3.500	88.90	8.625	219.08	1.25	31.75	58.5	1658

Stud Dimensions

Case Diam.	Stud Thread	P ± 0.039” (±1.0 mm)
1.38	M8	0.470” (12.0)
1.75	M8	0.470” (12.0)
2.00	M12	0.630” (16.0)
2.50	M12	0.630” (16.0)
3.00	M12	0.630” (16.0)
3.50	M12	0.630” (16.0)

Terminal Dimensions

Terminal Style	For Case Diameters	Code	Post Diameter		H max		Thread	min Full Thread		Torque	
			in	mm	in	mm		in	mm	in-lb	N-m
Low Post	1 ³ / ₈ to 3	A	0.314	8.0	0.094	2.4	10-32	0.218	5.5	25	2.82
High Post	1 ³ / ₈ to 3	B	0.314	8.0	0.281	7.1	10-32	0.375	9.5	25	2.82
High Current, Low	2 ¹ / ₂ to 3 ¹ / ₂	D	0.684	17.4	0.125	3.2	¼-28	0.344	8.7	60	6.78
High Current, High	2 ¹ / ₂ to 3 ¹ / ₂	E	0.684	17.4	0.281	7.1	¼-28	0.469	11.9	60	6.78
M5 Post, Small	1 ³ / ₈ to 2	M	0.314	8.0	0.281	7.1	M5	0.375	9.5	25	2.82
M5 Post	2 ¹ / ₂ & 3	F	0.512	13.0	0.230	5.8	M5	0.344	8.7	25	2.82
M6 Low Post	2 ¹ / ₂ to 3 ¹ / ₂	G	0.684	17.4	0.125	3.2	M6	0.344	8.7	60	6.78
M6 High Post	2 ¹ / ₂ to 3 ¹ / ₂	H	0.684	17.4	0.281	7.1	M6	0.469	11.9	60	6.78

NOTE: Only high post and M5 post terminals are available at 550 Vdc as they meet the required creepage distance.

[Click here to see Hardware & Mounting Options](#)

Type 500C 95 °C Long-Life, Screw Terminal, Aluminum Electrolytic

Part Numbering System

500C	492	U	063	AA	2	B	S
Type	Capacitance	Tolerance	Voltage	Case Code	Insulation	Terminal	Can Style
500C	100 = 10 μ F 101 = 100 μ F 492 = 4900 μ F 433 = 43,000 μ F	M= 20% U= 10%+75% T= 10%+50%	6R3 = 6.3 Vdc 063 = 63 Vdc 100 = 100 Vdc		0= None 1= Polyester 2= PVC	A= Low Post B= High Post D= High Current, Low Post E= High Current, High Post F or M= M5 Post G= M6 Low Post H= M6 High Post	Blank = Standard Can S = Stud Bottom P = Stud with Thermal Pad

Standard insulation is 0.008-in PVC sleeve with 0.01-in polypropylene end disk. Polyester insulation is not available for 3.5 inch diameter units.

Typical Performance Curves

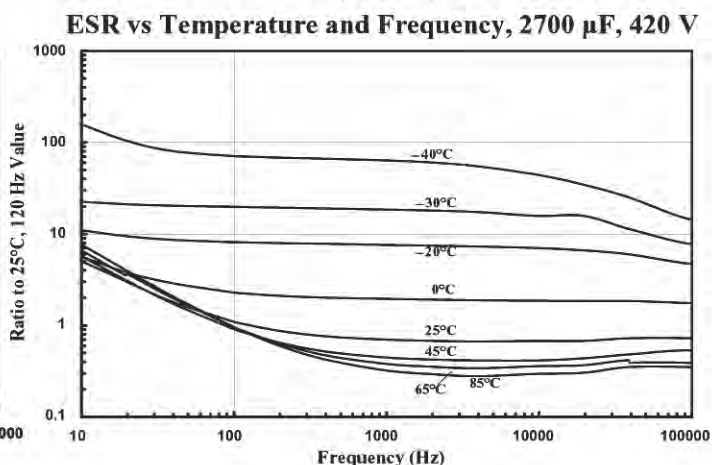
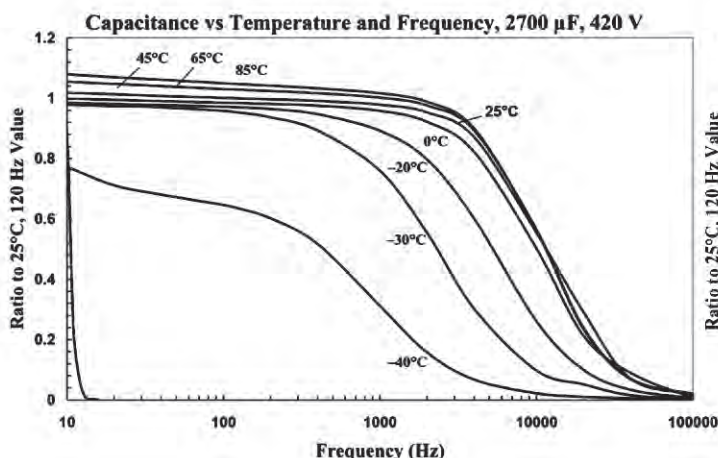
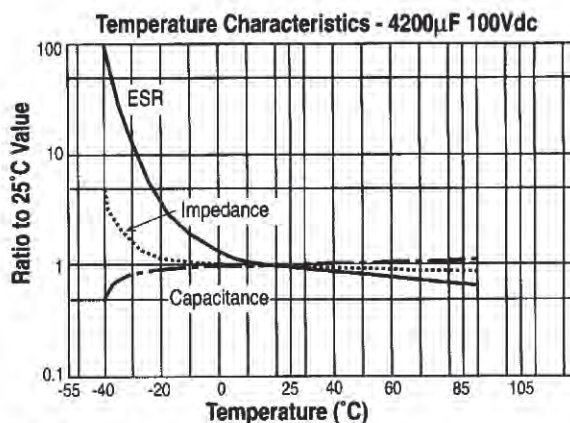
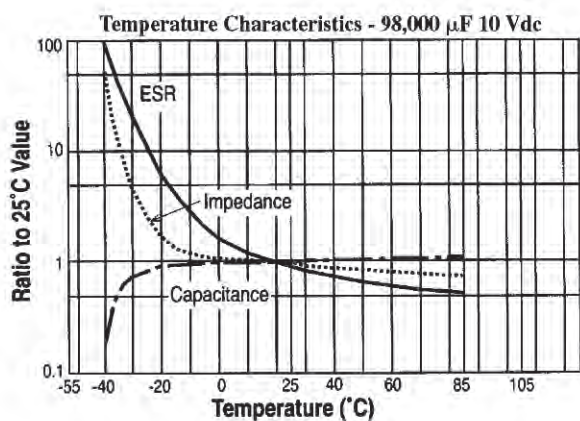
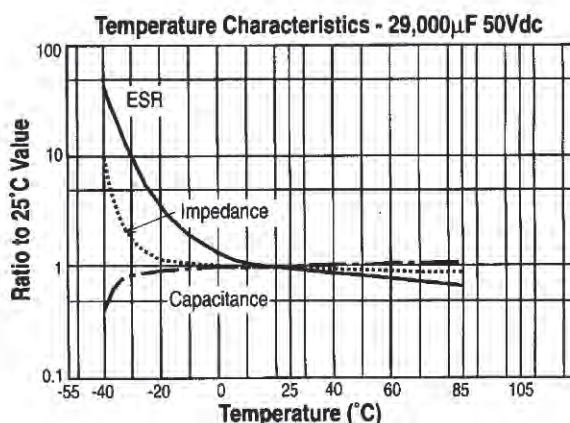
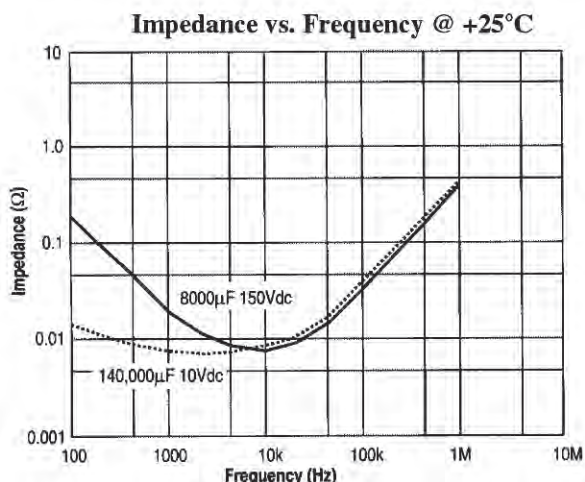

Type 500C 95 °C Long-Life, Screw Terminal, Aluminum Electrolytic

Typical Performance Curves

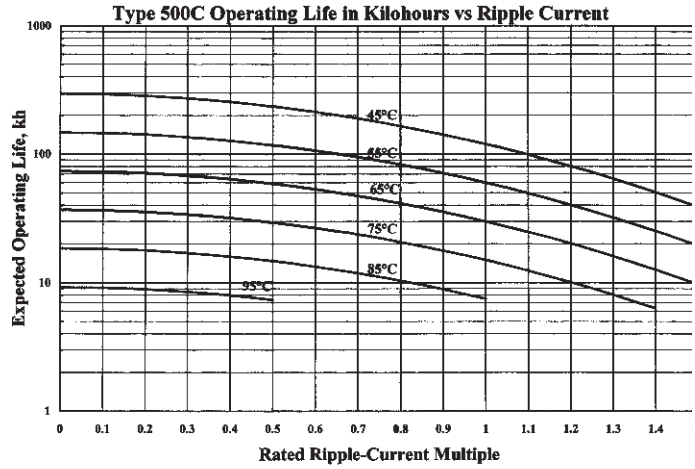
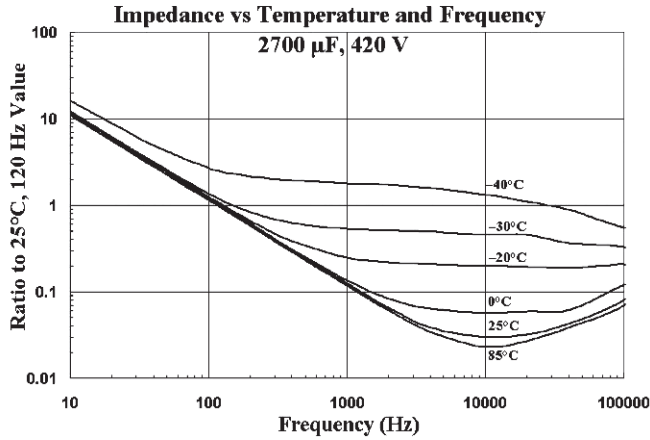

Ratings

Cap. (µF)	Catalog Part Number	ESR Max. @ 25 °C 120 Hz (mΩ)	Ripple Max. @ 85 °C 120 Hz (A)	Nominal Size D x L (inches)
6.3 Vdc (8 Vdc Surge)				
27000	500C273U6R3AK2B	46.9	4.70	1 3/8 x 1 5/8
55000	500C553U6R3AA2B	26.5	6.90	1 3/8 x 2 1/8
66000	500C663U6R3AH2B	18.8	8.90	1 3/8 x 2 5/8
87000	500C873U6R3AB2B	14.7	10.70	1 3/8 x 3 1/8
96000	500C963U6R3EA2B	18.8	9.60	1 3/4 x 2 1/8
110000	500C114U6R3AJ2B	12.8	12.10	1 3/8 x 3 5/8
120000	500C124U6R3EH2B	14.3	11.80	1 3/4 x 2 5/8
120000	500C124U6R3BA2B	14.2	12.00	2 x 2 1/8
130000	500C134U6R3AC2B	11.0	13.70	1 3/8 x 4 1/8
140000	500C144U6R3BH2B	9.9	15.50	2 x 2 5/8
150000	500C154U6R3AD2B	9.8	15.20	1 3/8 x 4 5/8
160000	500C164U6R3EB2B	11.0	14.30	1 3/4 x 3 1/8
170000	500C174U6R3AE2B	8.9	16.50	1 3/8 x 5 1/8
190000	500C194U6R3AF2B	8.3	17.80	1 3/8 x 5 5/8
190000	500C194U6R3EJ2B	9.1	16.60	1 3/4 x 3 5/8
200000	500C204U6R3BB2B	7.8	18.40	2 x 3 1/8
230000	500C234U6R3EC2B	7.9	18.70	1 3/4 x 4 1/8
250000	500C254U6R3BJ2B	6.5	21.40	2 x 3 5/8
250000	500C254U6R3CH2B	6.9	21.20	2 1/2 x 2 5/8
270000	500C274U6R3ED2B	7.0	20.60	1 3/4 x 4 5/8
300000	500C304U6R3BC2B	5.6	24.10	2 x 4 1/8
310000	500C314U6R3EE2B	6.4	22.40	1 3/4 x 5 1/8
340000	500C344U6R3CB2B	5.3	25.80	2 1/2 x 3 1/8
350000	500C354U6R3EF2B	6.0	24.00	1 3/4 x 5 5/8
360000	500C364U6R3BD2B	5.0	26.60	2 x 4 5/8
410000	500C414U6R3BE2B	4.5	28.80	2 x 5 1/8
420000	500C424U6R3CJ2B	4.3	29.90	2 1/2 x 3 5/8
450000	500C454U6R3BF2D	4.2	30.90	2 x 5 5/8
500000	500C504U6R3DB2D	4.1	32.90	3 x 3 1/8

Cap. (µF)	Catalog Part Number	ESR Max. @ 25 °C 120 Hz (mΩ)	Ripple Max. @ 85 °C 120 Hz (A)	Nominal Size D x L (inches)
510000	500C514U6R3CC2D	3.8	33.40	2 1/2 x 4 1/8
580000	500C584U6R3CD2D	3.4	36.80	2 1/2 x 4 5/8
620000	500C624U6R3DJ2D	3.3	38.20	3 x 3 5/8
680000	500C684U6R3CE2D	3.1	40.00	2 1/2 x 5 1/8
740000	500C744U6R3DC2D	2.9	42.50	3 x 4 1/8
760000	500C764U6R3CF2D	2.8	42.90	2 1/2 x 5 5/8
880000	500C884U6R3DD2D	2.6	46.70	3 x 4 5/8
980000	500C984U6R3DE2D	2.4	50.60	3 x 5 1/8
1100000	500C115U6R3DF2D	2.4	51.30	3 x 5 5/8
1100000	500C115U6R3FC2D	3.0	46.40	3 1/2 x 4 1/8
1100000	500C115U6R3FD2D	2.6	51.00	3 1/2 x 4 5/8
1200000	500C125U6R3DP2D	2.4	52.00	3 x 5 7/8
1400000	500C145U6R3FE2D	2.4	55.40	3 1/2 x 5 1/8
1600000	500C165U6R3FF2D	2.4	56.10	3 1/2 x 5 5/8
1600000	500C165U6R3DN2D	2.6	55.90	3 x 7 5/8
1700000	500C175U6R3FP2D	2.4	57.00	3 1/2 x 5 7/8
1800000	500C185U6R3DG2D	2.4	58.60	3 x 8 5/8
2300000	500C235U6R3FN2D	2.4	61.70	3 1/2 x 7 5/8
2600000	500C265U6R3FG2D	2.4	64.40	3 1/2 x 8 5/8
10 Vdc (12 Vdc Surge)				
22000	500C223U010AK2B	46.9	4.70	1 3/8 x 1 5/8
39000	500C393U010AA2B	26.5	6.90	1 3/8 x 2 1/8
52000	500C523U010AH2B	20.1	8.60	1 3/8 x 2 5/8
70000	500C703U010AB2B	15.5	10.50	1 3/8 x 3 1/8
71000	500C713U010EA2B	18.8	9.60	1 3/4 x 2 1/8
87000	500C873U010AJ2B	12.8	12.10	1 3/8 x 3 5/8
95000	500C953U010EH2B	14.3	11.80	1 3/4 x 2 5/8
100000	500C104U010AC2B	11.0	13.70	1 3/8 x 4 1/8
100000	500C104U010BA2B	17.6	10.70	2 x 2 1/8
120000	500C124U010AD2B	9.8	15.20	1 3/8 x 4 5/8

Type 500C 95 °C Long-Life, Screw Terminal, Aluminum Electrolytic

Cap. (µF)	Catalog Part Number	ESR Max. @ 25 °C 120 Hz (mΩ)	Ripple Max. @ 85°C 120 Hz (A)	Nominal Size D x L (inches)	Cap. (µF)	Catalog Part Number	ESR Max. @ 25 °C 120 Hz (mΩ)	Ripple Max. @ 85°C 120 Hz (A)	Nominal Size D x L (inches)
130000	500C134U010EB2B	11.0	14.30	1 3/4 x 3 1/8	85000	500C853U016AD2B	9.8	15.20	1 3/8 x 4 5/8
130000	500C134U010BH2B	13.4	13.30	2 x 2 5/8	88000	500C883U016EB2B	12.5	13.50	1 3/4 x 3 1/8
140000	500C144U010AE2B	8.9	16.50	1 3/8 x 5 1/8	90000	500C903U016BH2B	13.4	13.30	2 x 2 5/8
160000	500C164U010AF2B	8.3	17.80	1 3/8 x 5 5/8	97000	500C973U016AE2B	8.9	16.50	1 3/8 x 5 1/8
160000	500C164U010EJ2B	9.1	16.60	1 3/4 x 3 5/8	110000	500C114U016AF2B	8.3	17.80	1 3/8 x 5 5/8
160000	500C164U010BB2B	10.5	16.00	2 x 3 1/8	110000	500C114U016EJ2B	10.9	15.20	1 3/4 x 3 5/8
190000	500C194U010EC2B	7.9	18.70	1 3/4 x 4 1/8	110000	500C114U016BB2B	10.5	16.00	2 x 3 1/8
200000	500C204U010BJ2B	8.7	18.50	2 x 3 5/8	130000	500C134U016EC2B	9.7	16.90	1 3/4 x 4 1/8
200000	500C204U010CH2B	8.8	18.90	2 1/2 x 2 5/8	140000	500C144U016BJ2B	8.7	18.50	2 x 3 5/8
220000	500C224U010ED2B	7.0	20.60	1 3/4 x 4 5/8	140000	500C144U016CH2B	8.8	18.90	2 1/2 x 2 5/8
240000	500C244U010BC2B	7.5	20.80	2 x 4 1/8	150000	500C154U016ED2B	8.8	18.50	1 3/4 x 4 5/8
250000	500C254U010EE2B	6.4	22.40	1 3/4 x 5 1/8	170000	500C174U016BC2B	7.5	20.80	2 x 4 1/8
270000	500C274U010CB2B	6.7	22.90	2 1/2 x 3 1/8	180000	500C184U016EE2B	8.2	19.90	1 3/4 x 5 1/8
280000	500C284U010EF2B	6.0	24.00	1 3/4 x 5 5/8	190000	500C194U016CB2B	6.7	22.90	2 1/2 x 3 1/8
280000	500C284U010BD2B	6.7	22.90	2 x 4 5/8	200000	500C204U016EF2B	7.8	21.10	1 3/4 x 5 5/8
320000	500C324U010BE2B	6.1	24.80	2 x 5 1/8	200000	500C204U016BD2B	6.7	22.90	2 x 4 5/8
340000	500C344U010CJ2B	5.5	26.50	2 1/2 x 3 5/8	220000	500C224U016BE2B	6.1	24.80	2 x 5 1/8
360000	500C364U010BF2B	5.7	26.50	2 x 5 5/8	230000	500C234U016CJ2B	5.5	26.50	2 1/2 x 3 5/8
400000	500C404U010DB2D	4.1	32.90	3 x 3 1/8	250000	500C254U016BF2B	5.7	26.50	2 x 5 5/8
410000	500C414U010CC2B	4.8	29.60	2 1/2 x 4 1/8	280000	500C284U016CC2B	5.0	29.20	2 1/2 x 4 1/8
480000	500C484U010CD2D	4.3	32.60	2 1/2 x 4 5/8	280000	500C284U016DB2D	4.2	32.40	3 x 3 1/8
500000	500C504U010DJ2D	3.3	38.20	3 x 3 5/8	320000	500C324U016CD2D	4.6	31.40	2 1/2 x 4 5/8
550000	500C554U010CE2D	3.9	35.30	2 1/2 x 5 1/8	350000	500C354U016DJ2D	3.6	36.80	3 x 3 5/8
600000	500C604U010DC2D	2.9	42.50	3 x 4 1/8	370000	500C374U016CE2D	4.4	33.40	2 1/2 x 5 1/8
610000	500C614U010CF2D	3.6	37.90	2 1/2 x 5 5/8	420000	500C424U016CF2D	4.2	35.20	2 1/2 x 5 5/8
700000	500C704U010DD2D	2.6	46.70	3 x 4 5/8	420000	500C424U016DC2D	3.3	40.20	3 x 4 1/8
800000	500C804U010DE2D	2.4	50.60	3 x 5 1/8	490000	500C494U016DD2D	3.1	42.80	3 x 4 5/8
830000	500C834U010FC2D	2.9	47.30	3 1/2 x 4 1/8	550000	500C554U016DE2D	2.8	46.20	3 x 5 1/8
870000	500C874U010DF2D	2.3	53.00	3 x 5 5/8	600000	500C604U016FC2D	2.9	47.30	3 1/2 x 4 1/8
930000	500C934U010DP2D	2.3	53.30	3 x 5 7/8	610000	500C614U016DF2D	2.8	48.10	3 x 5 5/8
970000	500C974U010FD2D	2.8	49.60	3 1/2 x 4 5/8	640000	500C644U016DP2D	2.8	48.80	3 x 5 7/8
1100000	500C115U010FE2D	2.5	54.50	3 1/2 x 5 1/8	700000	500C704U016FD2D	2.8	49.70	3 1/2 x 4 5/8
1200000	500C125U010FF2D	2.2	59.00	3 1/2 x 5 5/8	800000	500C804U016FE2D	2.5	54.40	3 1/2 x 5 1/8
1300000	500C135U010FP2D	2.1	60.80	3 1/2 x 5 7/8	870000	500C874U016FF2D	2.4	56.70	3 1/2 x 5 5/8
1300000	500C135U010DN2D	2.1	60.10	3 x 7 5/8	870000	500C874U016DN2D	2.6	54.10	3 x 7 5/8
1500000	500C155U010DG2D	2.1	63.70	3 x 8 5/8	920000	500C924U016FP2D	2.4	57.30	3 1/2 x 5 7/8
1700000	500C175U010FN2D	1.8	73.40	3 1/2 x 7 5/8	1000000	500C105U016DG2D	2.6	57.10	3 x 8 5/8
2000000	500C205U010FG2D	1.5	80.50	3 1/2 x 8 5/8	1300000	500C135U016FN2D	2.3	63.10	3 1/2 x 7 5/8
16 Vdc (20 Vdc Surge)					25 Vdc (30 Vdc Surge)				
15000	500C153U016AK2B	46.9	4.7	1 3/8 x 1 5/8	11000	500C113U025AK2B	37.1	5.30	1 3/8 x 1 5/8
27000	500C273U016AA2B	26.5	6.9	1 3/8 x 2 1/8	18000	500C183U025AA2B	23.6	7.40	1 3/8 x 2 1/8
36000	500C363U016AH2B	20.1	8.6	1 3/8 x 2 5/8	26000	500C263U025AH2B	16.9	9.40	1 3/8 x 2 5/8
48000	500C483U016AB2B	15.5	10.5	1 3/8 x 3 1/8	33000	500C333U025EA2B	21.8	8.90	1 3/4 x 2 1/8
49000	500C493U016EA2B	18.8	9.6	1 3/4 x 2 1/8	34000	500C343U025AB2B	17.1	10.00	1 3/8 x 3 1/8
61000	500C613U016AJ2B	12.8	12.1	1 3/8 x 3 5/8	39000	500C393U025EH2B	19.4	10.20	1 3/4 x 2 5/8
66000	500C663U016EH2B	15.3	11.4	1 3/4 x 2 5/8	43000	500C433U025AJ2B	17.7	10.30	1 3/8 x 3 5/8
71000	500C713U016BA2B	17.6	10.7	2 x 2 1/8	47000	500C473U025BA2B	21.8	9.70	2 x 2 1/8
73000	500C733U016AC2B	11.0	13.7	1 3/8 x 4 1/8					

Type 500C 95 °C Long-Life, Screw Terminal, Aluminum Electrolytic

Cap. (µF)	Catalog Part Number	ESR Max. @ 25 °C 120 Hz (mΩ)	Ripple Max. @ 85°C 120 Hz (A)	Nominal Size D x L (inches)	Cap. (µF)	Catalog Part Number	ESR Max. @ 25 °C 120 Hz (mΩ)	Ripple Max. @ 85°C 120 Hz (A)	Nominal Size D x L (inches)
51000	500C513U025AC2B	16.3	11.30	1 3/8 x 4 1/8	32000	500C323U035AC2B	18.7	10.50	1 3/8 x 4 1/8
53000	500C533U025BH2B	16.5	12.00	2 x 2 5/8	33000	500C333U035BH2B	20.1	10.80	2 x 2 5/8
54000	500C543U025EB2B	15.2	12.20	1 3/4 x 3 1/8	34000	500C343U035EB2B	15.5	12.10	1 3/4 x 3 1/8
60000	500C603U025AD2B	15.4	12.10	1 3/8 x 4 5/8	37000	500C373U035AD2B	16.7	11.60	1 3/8 x 4 5/8
69000	500C693U025AE2B	14.4	13.00	1 3/8 x 5 1/8	42000	500C423U035AE2B	14.8	12.90	1 3/8 x 5 1/8
69000	500C693U025BB2B	12.2	14.80	2 x 3 1/8	43000	500C433U035EJ2B	13.2	13.80	1 3/4 x 3 5/8
70000	500C703U025EJ2B	12.8	14.10	1 3/4 x 3 5/8	43000	500C433U035BB2B	15.9	13.00	2 x 3 1/8
77000	500C773U025AF2B	13.4	14.00	1 3/8 x 5 5/8	48000	500C483U035AF2B	13.5	14.00	1 3/8 x 5 5/8
82000	500C823U025CH2B	9.5	18.10	2 1/2 x 2 5/8	51000	500C513U035CH2B	14.8	14.50	2 1/2 x 2 5/8
86000	500C863U025EC2B	11.2	15.70	1 3/4 x 4 1/8	53000	500C533U035EC2B	11.8	15.30	1 3/4 x 4 1/8
89000	500C893U025BJ2B	9.8	17.40	2 x 3 5/8	55000	500C553U035BJ2B	13.2	15.00	2 x 3 5/8
100000	500C104U025ED2B	10.2	17.10	1 3/4 x 4 5/8	62000	500C623U035ED2B	10.6	16.80	1 3/4 x 4 5/8
110000	500C114U025BC2B	8.3	19.70	2 x 4 1/8	67000	500C673U035BC2B	11.6	16.70	2 x 4 1/8
110000	500C114U025CB2B	7.6	21.50	2 1/2 x 3 1/8	71000	500C713U035CB2B	11.5	17.50	2 1/2 x 3 1/8
120000	500C124U025EE2B	9.6	18.40	1 3/4 x 5 1/8	72000	500C723U035EE2B	9.8	18.20	1 3/4 x 5 1/8
130000	500C134U025EF2B	9.1	19.50	1 3/4 x 5 5/8	80000	500C803U035BD2B	10.5	18.20	2 x 4 5/8
130000	500C134U025BD2B	7.3	21.90	2 x 4 5/8	82000	500C823U035EF2B	9.4	19.20	1 3/4 x 5 5/8
150000	500C154U025BE2B	6.6	23.90	2 x 5 1/8	91000	500C913U035CJ2B	9.4	20.30	2 1/2 x 3 5/8
150000	500C154U025CJ2B	6.4	24.60	2 1/2 x 3 5/8	92000	500C923U035BE2B	9.8	19.50	2 x 5 1/8
170000	500C174U025BF2B	6.1	25.70	2 x 5 5/8	100000	500C104U035BF2B	9.4	20.70	2 x 5 5/8
170000	500C174U025DB2B	5.0	29.70	3 x 3 1/8	110000	500C114U035CC2B	8.2	22.60	2 1/2 x 4 1/8
180000	500C184U025CC2B	5.8	27.00	2 1/2 x 4 1/8	110000	500C114U035DB2B	6.9	25.30	3 x 3 1/8
210000	500C214U025CD2B	5.2	29.50	2 1/2 x 4 5/8	130000	500C134U035CD2B	7.4	24.80	2 1/2 x 4 5/8
220000	500C224U025DJ2D	4.3	31.10	3 x 3 5/8	140000	500C144U035DJ2B	5.7	29.10	3 x 3 5/8
250000	500C254U025CE2D	5.0	33.60	2 1/2 x 5 1/8	150000	500C154U035CE2B	6.8	26.80	2 1/2 x 5 1/8
270000	500C274U025DC2D	3.9	36.90	3 x 4 1/8	170000	500C174U035CF2B	6.1	29.20	2 1/2 x 5 5/8
280000	500C284U025CF2D	4.6	33.70	2 1/2 x 5 5/8	170000	500C174U035DC2D	5.2	32.00	3 x 4 1/8
320000	500C324U025DD2D	3.5	40.00	3 x 4 5/8	200000	500C204U035DD2D	4.7	34.80	3 x 4 5/8
370000	500C374U025DE2D	3.3	42.70	3 x 5 1/8	230000	500C234U035DE2D	4.4	37.20	3 x 5 1/8
390000	500C394U025FC2D	3.8	40.90	3 1/2 x 4 1/8	240000	500C244U035FC2D	4.9	36.00	3 1/2 x 4 1/8
420000	500C424U025DF2D	3.2	44.90	3 x 5 5/8	260000	500C264U035DF2D	4.0	39.90	3 x 5 5/8
440000	500C444U025DP2D	3.1	46.50	3 x 5 7/8	270000	500C274U035DP2D	3.9	41.30	3 x 5 7/8
460000	500C464U025FD2D	3.5	44.40	3 1/2 x 4 5/8	280000	500C284U035FD2D	4.5	39.00	3 1/2 x 4 5/8
530000	500C534U025FE2D	3.2	47.40	3 1/2 x 5 1/8	330000	500C334U035FE2D	4.0	42.60	3 1/2 x 5 1/8
600000	500C604U025FF2D	3.1	50.20	3 1/2 x 5 5/8	370000	500C374U035FF2D	3.6	46.00	3 1/2 x 5 5/8
610000	500C614U025DN2D	3.1	50.20	3 x 7 5/8	380000	500C384U035DN2D	3.8	45.30	3 x 7 5/8
630000	500C634U025FP2D	2.9	51.80	3 1/2 x 5 7/8	390000	500C394U035FP2D	3.5	47.50	3 1/2 x 5 7/8
710000	500C714U025DG2D	3.0	52.80	3 x 8 5/8	440000	500C444U035DG2D	3.6	48.10	3 x 8 5/8
870000	500C874U025FN2D	3.0	55.60	3 1/2 x 7 5/8	540000	500C544U035FN2D	3.4	52.10	3 1/2 x 7 5/8
1000000	500C105U025FG2D	2.9	58.30	3 1/2 x 8 5/8	630000	500C634U035FG2D	3.3	55.20	3 1/2 x 8 5/8
35 Vdc (40 Vdc Surge)					50 Vdc (65 Vdc Surge)				
6600	500C662U035AK2B	41.7	5.00	1 3/8 x 1 5/8	4500	500C452U050AK2B	47.9	4.70	1 3/8 x 1 5/8
11000	500C113U035AA2B	26.7	6.90	1 3/8 x 2 1/8	7600	500C762U050AA2B	30.9	6.40	1 3/8 x 2 1/8
16000	500C163U035AH2B	19.5	8.70	1 3/8 x 2 5/8	11000	500C113U050AH2B	21.8	8.30	1 3/8 x 2 5/8
20000	500C203U035EA2B	22.3	8.80	1 3/4 x 2 1/8	14000	500C143U050AB2B	20.9	9.00	1 3/8 x 3 1/8
21000	500C213U035AB2B	19.4	9.30	1 3/8 x 3 1/8	14000	500C143U050EA2B	22.8	8.70	1 3/4 x 2 1/8
24000	500C243U035EH2B	19.2	10.20	1 3/4 x 2 5/8	16000	500C163U050EH2B	20.2	10.00	1 3/4 x 2 5/8
26000	500C263U035AJ2B	19.7	9.80	1 3/8 x 3 5/8	17000	500C173U050BA2B	25.3	9.00	2 x 2 1/8
26000	500C263U035BA2B	24.5	9.10	2 x 2 1/8	18000	500C183U050AJ2B	17.8	10.30	1 3/8 x 3 5/8

Type 500C 95 °C Long-Life, Screw Terminal, Aluminum Electrolytic

Cap. (µF)	Catalog Part Number	ESR Max. @ 25 °C 120 Hz (mΩ)	Ripple Max. @ 85°C 120 Hz (A)	Nominal Size D x L (inches)
21000	500C213U050AC2B	17.3	11.00	1 3/8 x 4 1/8
22000	500C223U050BH2B	20.8	10.70	2 x 2 5/8
23000	500C233U050EB2B	15.6	12.10	1 3/4 x 3 1/8
25000	500C253U050AD2B	16.8	11.60	1 3/8 x 4 5/8
29000	500C293U050AE2B	15.1	12.70	1 3/8 x 5 1/8
29000	500C293U050EJ2B	13.5	13.60	1 3/4 x 3 5/8
29000	500C293U050BB2B	16.3	12.80	2 x 3 1/8
32000	500C323U050AF2B	13.8	13.80	1 3/8 x 5 5/8
34000	500C343U050CH2B	15.1	14.40	2 1/2 x 2 5/8
36000	500C363U050EC2B	12.0	15.20	1 3/4 x 4 1/8
37000	500C373U050BJ2B	13.6	14.80	2 x 3 5/8
42000	500C423U050ED2B	10.8	16.60	1 3/4 x 4 5/8
46000	500C463U050BC2B	11.9	16.50	2 x 4 1/8
48000	500C483U050CB2B	12.0	17.10	2 1/2 x 3 1/8
49000	500C493U050EE2B	9.8	18.10	1 3/4 x 5 1/8
54000	500C543U050BD2B	10.8	18.00	2 x 4 5/8
55000	500C553U050EF2B	9.5	19.10	1 3/4 x 5 5/8
62000	500C623U050BE2B	10.0	19.40	2 x 5 1/8
62000	500C623U050CJ2B	10.3	19.40	2 1/2 x 3 5/8
70000	500C703U050BF2B	9.5	20.50	2 x 5 5/8
72000	500C723U050DB2B	9.1	22.00	3 x 3 1/8
75000	500C753U050CC2B	8.9	21.80	2 1/2 x 4 1/8
89000	500C893U050CD2B	7.9	24.00	2 1/2 x 4 5/8
92000	500C923U050DJ2B	7.7	25.10	3 x 3 5/8
100000	500C104U050CE2B	7.2	26.00	2 1/2 x 5 1/8
110000	500C114U050DC2B	6.9	27.60	3 x 4 1/8
120000	500C124U050CF2B	6.7	27.90	2 1/2 x 5 5/8
130000	500C134U050DD2D	6.1	30.40	3 x 4 5/8
150000	500C154U050DE2D	5.9	32.00	3 x 5 1/8
150000	500C154U050FC2D	6.4	31.70	3 1/2 x 4 1/8
170000	500C174U050DF2D	5.6	33.80	3 x 5 5/8
180000	500C184U050DP2D	5.4	35.00	3 x 5 7/8
180000	500C184U050FD2D	5.7	34.70	3 1/2 x 4 5/8
200000	500C204U050FE2D	5.4	36.80	3 1/2 x 5 1/8
230000	500C234U050FF2D	5.0	39.00	3 1/2 x 5 5/8
250000	500C254U050FP2D	5.0	40.00	3 1/2 x 5 7/8
260000	500C264U050DN2D	5.0	42.00	3 x 7 5/8
300000	500C304U050DG2D	4.0	45.00	3 x 8 5/8
340000	500C344U050FN2D	4.0	47.00	3 1/2 x 7 5/8
400000	500C404U050FG2D	4.0	51.00	3 1/2 x 8 5/8
63 Vdc (75 Vdc Surge)				
3400	500C342U063AK2B	60.6	4.10	1 3/8 x 1 5/8
5800	500C582U063AA2B	39.0	5.70	1 3/8 x 2 1/8
8200	500C822U063AH2B	27.4	7.40	1 3/8 x 2 5/8
11000	500C113U063AB2B	25.2	8.20	1 3/8 x 3 1/8
11000	500C113U063EA2B	27.9	7.90	1 3/4 x 2 1/8
12000	500C123U063EH2B	25.6	8.80	1 3/4 x 2 5/8
13000	500C133U063BA2B	28.0	8.50	2 x 2 1/8
14000	500C143U063AJ2B	23.7	8.90	1 3/8 x 3 5/8

Cap. (µF)	Catalog Part Number	ESR Max. @ 25 °C 120 Hz (mΩ)	Ripple Max. @ 85°C 120 Hz (A)	Nominal Size D x L (inches)
15000	500C153U063BH2B	22.6	10.20	2 x 2 5/8
16000	500C163U063AC2B	20.4	10.10	1 3/8 x 4 1/8
17000	500C173U063EB2B	19.5	10.80	1 3/4 x 3 1/8
19000	500C193U063AD2B	18.1	11.20	1 3/8 x 4 5/8
20000	500C203U063BB2B	18.1	12.10	2 x 3 1/8
22000	500C223U063AE2B	16.4	12.20	1 3/8 x 5 1/8
22000	500C223U063EJ2B	16.2	12.50	1 3/4 x 3 5/8
24000	500C243U063CH2B	26.8	10.80	2 1/2 x 2 5/8
25000	500C253U063AF2B	15.1	13.20	1 3/8 x 5 5/8
26000	500C263U063BJ2B	15.1	14.00	2 x 3 5/8
27000	500C273U063EC2B	14.2	14.00	1 3/4 x 4 1/8
32000	500C323U063ED2B	12.8	15.30	1 3/4 x 4 5/8
32000	500C323U063BC2B	13.3	15.60	2 x 4 1/8
34000	500C343U063CB2B	19.3	13.50	2 1/2 x 3 1/8
37000	500C373U063EE2B	11.8	16.50	1 3/4 x 5 1/8
38000	500C383U063BD2B	12.1	17.00	2 x 4 5/8
42000	500C423U063EF2B	11.2	17.60	1 3/4 x 5 5/8
43000	500C433U063CJ2B	17.1	15.10	2 1/2 x 3 5/8
44000	500C443U063BE2B	11.3	18.30	2 x 5 1/8
49000	500C493U063BF2B	10.7	19.40	2 x 5 5/8
50000	500C503U063DB2B	14.9	17.20	3 x 3 1/8
53000	500C533U063CC2B	13.7	17.50	2 1/2 x 4 1/8
62000	500C623U063CD2B	11.8	19.60	2 1/2 x 4 5/8
65000	500C653U063DJ2B	12.1	20.00	3 x 3 5/8
72000	500C723U063CE2B	11.0	21.10	2 1/2 x 5 1/8
79000	500C793U063DC2B	10.8	22.10	3 x 4 1/8
82000	500C823U063CF2B	10.5	22.30	2 1/2 x 5 5/8
93000	500C933U063DD2B	9.9	23.90	3 x 4 5/8
110000	500C114U063DE2B	8.8	26.30	3 x 5 1/8
110000	500C114U063FC2D	9.9	25.40	3 1/2 x 4 1/8
120000	500C124U063DF2B	7.9	28.50	3 x 5 5/8
130000	500C134U063DP2B	7.5	29.60	3 x 5 7/8
130000	500C134U063FD2D	9.0	27.60	3 1/2 x 4 5/8
150000	500C154U063FE2D	7.9	30.30	3 1/2 x 5 1/8
170000	500C174U063FF2D	7.2	32.80	3 1/2 x 5 5/8
180000	500C184U063DN2D	6.5	35.00	3 x 7 5/8
180000	500C184U063FP2D	6.8	34.00	3 1/2 x 5 7/8
210000	500C214U063DG2D	5.7	38.30	3 x 8 5/8
250000	500C254U063FN2D	5.8	40.20	3 1/2 x 7 5/8
290000	500C294U063FG2D	5.2	43.90	3 1/2 x 8 5/8
75 Vdc (95 Vdc Surge)				
2700	500C272U075AK2B	76.2	3.70	1 3/8 x 1 5/8
4300	500C432U075AA2B	50.7	5.00	1 3/8 x 2 1/8
6400	500C642U075AH2B	35.0	6.50	1 3/8 x 2 5/8
8300	500C832U075EA2B	55.6	5.60	1 3/4 x 2 1/8
8600	500C862U075AB2B	34.0	7.10	1 3/8 x 3 1/8
9800	500C982U075EH2B	47.3	6.50	1 3/4 x 2 5/8
10000	500C103U075BA2B	34.8	7.70	2 x 2 1/8
11000	500C113U075AJ2B	31.1	7.80	1 3/8 x 3 5/8

Type 500C 95 °C Long-Life, Screw Terminal, Aluminum Electrolytic

Cap. (µF)	Catalog Part Number	ESR Max. @ 25 °C 120 Hz (mΩ)	Ripple Max. @ 85°C 120 Hz (A)	Nominal Size D x L (inches)	Cap. (µF)	Catalog Part Number	ESR Max. @ 25 °C 120 Hz (mΩ)	Ripple Max. @ 85°C 120 Hz (A)	Nominal Size D x L (inches)
11000	500C113U075BH2B	27.5	9.30	2 x 2 5/8	7300	500C732U100BH2B	37.8	7.90	2 x 2 5/8
13000	500C133U075AC2B	28.2	8.60	1 3/8 x 4 1/8	7600	500C762U100AC2B	30.7	8.20	1 3/8 x 4 1/8
14000	500C143U075EB2B	34.1	8.20	1 3/4 x 3 1/8	8100	500C812U100EB2B	38.0	7.70	1 3/4 x 3 1/8
15000	500C153U075AD2B	24.5	9.60	1 3/8 x 4 5/8	8900	500C892U100AD2B	29.0	8.80	1 3/8 x 4 5/8
16000	500C163U075BB2B	21.4	11.20	2 x 3 1/8	10000	500C103U100AE2B	28.3	9.30	1 3/8 x 5 1/8
17000	500C173U075AE2B	22.5	10.40	1 3/8 x 5 1/8	10000	500C103U100EJ2B	29.9	9.20	1 3/4 x 3 5/8
18000	500C183U075EJ2B	26.9	9.70	1 3/4 x 3 5/8	10000	500C103U100BB2B	30.6	9.30	2 x 3 1/8
19000	500C193U075AF2B	20.4	11.30	1 3/8 x 5 5/8	11000	500C113U100AF2B	27.6	9.70	1 3/8 x 5 5/8
19000	500C193U075CH2B	30.0	10.20	2 1/2 x 2 5/8	12000	500C123U100CH2B	33.7	9.60	2 1/2 x 2 5/8
21000	500C213U075EC2B	22.3	11.10	1 3/4 x 4 1/8	13000	500C133U100EC2B	24.8	10.60	1 3/4 x 4 1/8
21000	500C213U075BJ2B	18.0	12.80	2 x 3 5/8	13000	500C133U100BJ2B	22.3	11.50	2 x 3 5/8
25000	500C253U075ED2B	19.2	12.50	1 3/4 x 4 5/8	15000	500C153U100ED2B	21.2	11.90	1 3/4 x 4 5/8
25000	500C253U075BC2B	15.6	14.40	2 x 4 1/8	16000	500C163U100BC2B	19.9	12.80	2 x 4 1/8
26000	500C263U075CB2B	21.6	12.70	2 1/2 x 3 1/8	17000	500C173U100EE2B	18.7	13.10	1 3/4 x 5 1/8
29000	500C293U075EE2B	16.9	13.80	1 3/4 x 5 1/8	17000	500C173U100CB2B	23.4	12.30	2 1/2 x 3 1/8
30000	500C303U075BD2B	13.9	15.80	2 x 4 5/8	19000	500C193U100BD2B	17.7	14.10	2 x 4 5/8
33000	500C333U075EF2B	15.2	15.10	1 3/4 x 5 5/8	20000	500C203U100EF2B	16.8	14.30	1 3/4 x 5 5/8
34000	500C343U075BE2B	12.8	17.10	2 x 5 1/8	22000	500C223U100BE2B	15.6	15.50	2 x 5 1/8
34000	500C343U075CJ2B	17.8	14.80	2 1/2 x 3 5/8	22000	500C223U100CJ2B	19.1	14.30	2 1/2 x 3 5/8
39000	500C393U075BF2B	12.0	18.30	2 x 5 5/8	25000	500C253U100BF2B	14.9	16.40	2 x 5 5/8
40000	500C403U075DB2B	18.0	15.60	3 x 3 1/8	25000	500C253U100DB2B	19.9	14.90	3 x 3 1/8
42000	500C423U075CC2B	15.1	16.70	2 1/2 x 4 1/8	27000	500C273U100CC2B	16.5	16.00	2 1/2 x 4 1/8
49000	500C493U075CD2B	13.5	18.40	2 1/2 x 4 5/8	32000	500C323U100CD2B	14.7	17.60	2 1/2 x 4 5/8
51000	500C513U075DJ2B	14.4	18.30	3 x 3 5/8	33000	500C333U100DJ2B	16.4	17.20	3 x 3 5/8
57000	500C573U075CE2B	12.0	20.20	2 1/2 x 5 1/8	36000	500C363U100CE2B	13.4	19.10	2 1/2 x 5 1/8
62000	500C623U075DC2B	12.9	20.20	3 x 4 1/8	40000	500C403U100DC2B	14.4	19.10	3 x 4 1/8
64000	500C643U075CF2B	11.2	21.50	2 1/2 x 5 5/8	41000	500C413U100CF2B	12.5	20.40	2 1/2 x 5 5/8
74000	500C743U075DD2B	11.8	21.90	3 x 4 5/8	47000	500C473U100DD2B	13.0	20.90	3 x 4 5/8
85000	500C853U075DE2B	10.4	24.10	3 x 5 1/8	54000	500C543U100DE2B	12.0	22.50	3 x 5 1/8
85000	500C853U075FC2D	11.8	23.20	3 1/2 x 4 1/8	55000	500C553U100FC2D	13.4	21.80	3 1/2 x 4 1/8
96000	500C963U075DF2B	9.4	26.20	3 x 5 5/8	62000	500C623U100DF2B	11.2	23.90	3 x 5 5/8
100000	500C104U075DP2B	8.9	27.20	3 x 5 7/8	65000	500C653U100DP2B	11.1	24.40	3 x 5 7/8
100000	500C104U075FD2D	10.7	25.30	3 1/2 x 4 5/8	65000	500C653U100FD2D	12.1	23.80	3 1/2 x 4 5/8
120000	500C124U075FE2D	9.4	27.80	3 1/2 x 5 1/8	74000	500C743U100FE2D	10.9	25.90	3 1/2 x 5 1/8
130000	500C134U075FF2D	8.4	30.20	3 1/2 x 5 5/8	84000	500C843U100FF2D	10.2	27.50	3 1/2 x 5 5/8
140000	500C144U075DN2D	7.7	32.10	3 x 7 5/8	89000	500C893U100FP2D	10.0	28.10	3 1/2 x 5 7/8
140000	500C144U075FP2D	8.1	31.30	3 1/2 x 5 7/8	94000	500C943U100DN2D	9.2	29.40	3 x 7 5/8
160000	500C164U075DG2D	6.8	35.10	3 x 8 5/8	110000	500C114U100DG2D	8.2	32.10	3 x 8 5/8
190000	500C194U075FN2D	6.9	36.80	3 1/2 x 7 5/8	120000	500C124U100FN2D	8.3	33.70	3 1/2 x 7 5/8
220000	500C224U075FG2D	6.2	40.20	3 1/2 x 8 5/8	140000	500C144U100FG2D	7.3	36.80	3 1/2 x 8 5/8
100 Vdc (125 Vdc Surge)					160 Vdc (200 Vdc)				
1600	500C162U100AK2B	98.4	3.30	1 3/8 x 1 5/8	750	500C751T160AK2B	150.0	2.60	1 3/8 x 1 5/8
2500	500C252U100AA2B	60.2	4.60	1 3/8 x 2 1/8	1200	500C122T160AA2B	93.0	3.70	1 3/8 x 2 1/8
3800	500C382U100AH2B	42.7	5.90	1 3/8 x 2 5/8	1500	500C152T160AH2B	70.5	4.60	1 3/8 x 2 5/8
4900	500C492U100EA2B	62.0	5.30	1 3/4 x 2 1/8	2100	500C212T160AB2B	58.5	5.40	1 3/8 x 3 1/8
5100	500C512U100AB2B	38.2	6.70	1 3/8 x 3 1/8	2300	500C232T160EA2B	62.0	5.30	1 3/4 x 2 1/8
5100	500C512U100BA2B	51.8	6.30	2 x 2 1/8	2400	500C242T160BA2B	70.5	5.40	2 x 2 1/8
5800	500C582U100EH2B	52.8	6.20	1 3/4 x 2 5/8	2700	500C272T160AJ2B	50.2	6.10	1 3/8 x 3 5/8
6300	500C632U100AJ2B	33.0	7.60	1 3/8 x 3 5/8	2700	500C272T160EH2B	52.8	6.20	1 3/4 x 2 5/8

Type 500C 95 °C Long-Life, Screw Terminal, Aluminum Electrolytic

Cap. (µF)	Catalog Part Number	ESR Max. @ 25 °C 120 Hz (mΩ)	Ripple Max. @ 85°C 120 Hz (A)	Nominal Size D x L (inches)	Cap. (µF)	Catalog Part Number	ESR Max. @ 25 °C 120 Hz (mΩ)	Ripple Max. @ 85°C 120 Hz (A)	Nominal Size D x L (inches)
3300	500C332T160AC2B	42.9	7.00	1 3/8 x 4 1/8	2100	500C212T200AC2B	51.7	6.30	1 3/8 x 4 1/8
3500	500C352T160BH2B	46.5	7.10	2 x 2 5/8	2200	500C222T200BH2B	61.0	6.20	2 x 2 5/8
3800	500C382T160EB2B	38.0	7.70	1 3/4 x 3 1/8	2400	500C242T200EB2B	48.4	6.90	1 3/4 x 3 1/8
3900	500C392T160AD2B	37.7	7.70	1 3/8 x 4 5/8	2500	500C252T200AD2B	43.2	7.20	1 3/8 x 4 5/8
4500	500C452T160AE2B	34.7	8.40	1 3/8 x 5 1/8	2900	500C292T200AE2B	37.8	8.00	1 3/8 x 5 1/8
4900	500C492T160EJ2B	29.9	9.20	1 3/4 x 3 5/8	3100	500C312T200EJ2B	37.9	8.20	1 3/4 x 3 5/8
4900	500C492T160BB2B	33.5	8.90	2 x 3 1/8	3100	500C312T200BB2B	46.1	7.60	2 x 3 1/8
5100	500C512T160AF2B	32.2	9.00	1 3/8 x 5 5/8	3300	500C332T200AF2B	33.4	8.90	1 3/8 x 5 5/8
5500	500C552T160CH2B	30.1	10.20	2 1/2 x 2 5/8	3500	500C352T200CH2B	42.2	8.60	2 1/2 x 2 5/8
6000	500C602T160EC2B	24.8	10.60	1 3/4 x 4 1/8	3800	500C382T200EC2B	31.3	9.40	1 3/4 x 4 1/8
6300	500C632T160BJ2B	26.4	10.60	2 x 3 5/8	4000	500C402T200BJ2B	36.2	9.00	2 x 3 5/8
7100	500C712T160ED2B	21.2	11.90	1 3/4 x 4 5/8	4500	500C452T200ED2B	26.8	10.60	1 3/4 x 4 5/8
7700	500C772T160BC2B	21.9	12.20	2 x 4 1/8	4900	500C492T200BC2B	28.5	10.60	2 x 4 1/8
7700	500C772T160CB2B	21.3	12.80	2 1/2 x 3 1/8	4900	500C492T200CB2B	31.2	10.60	2 1/2 x 3 1/8
8200	500C822T160EE2B	18.7	13.10	1 3/4 x 5 1/8	5200	500C522T200EE2B	23.5	11.70	1 3/4 x 5 1/8
9100	500C912T160BD2B	18.8	13.60	2 x 4 5/8	5800	500C582T200BD2B	24.4	12.00	2 x 4 5/8
9300	500C932T160EF2B	16.8	14.30	1 3/4 x 5 5/8	5900	500C592T200EF2B	21.0	12.80	1 3/4 x 5 5/8
9900	500C992T160CJ2B	17.0	15.10	2 1/2 x 3 5/8	6200	500C622T200CJ2B	22.3	13.20	2 1/2 x 3 5/8
10000	500C103T160BE2B	16.6	15.00	2 x 5 1/8	6700	500C672T200BE2B	21.7	13.20	2 x 5 1/8
11000	500C113T160DB2B	14.7	17.30	3 x 3 1/8	7600	500C762T200BF2B	19.6	14.30	2 x 5 5/8
12000	500C123T160BF2B	14.9	16.40	2 x 5 5/8	7600	500C762T200CC2B	20.3	14.40	2 1/2 x 4 1/8
12000	500C123T160CC2B	14.1	17.30	2 1/2 x 4 1/8	7600	500C762T200DB2B	30.3	12.10	3 x 3 1/8
14000	500C143T160CD2B	11.9	19.60	2 1/2 x 4 5/8	9000	500C902T200CD2B	17.3	16.20	2 1/2 x 4 5/8
15000	500C153T160DJ2B	11.5	20.50	3 x 3 5/8	9800	500C982T200DJ2B	23.7	14.30	3 x 3 5/8
16000	500C163T160CE2B	10.7	21.30	2 1/2 x 5 1/8	10000	500C103T200CE2B	15.8	17.60	2 1/2 x 5 1/8
18000	500C183T160DC2B	9.6	23.40	3 x 4 1/8	12000	500C123T200CF2B	13.7	19.40	2 1/2 x 5 5/8
19000	500C193T160CF2B	9.6	23.20	2 1/2 x 5 5/8	12000	500C123T200DC2B	19.7	16.30	3 x 4 1/8
21000	500C213T160DD2B	8.2	26.20	3 x 4 5/8	14000	500C143T200DD2B	16.9	18.30	3 x 4 5/8
25000	500C253T160DE2B	7.3	28.90	3 x 5 1/8	15000	500C153T200FC2B	17.1	19.30	3 1/2 x 4 1/8
25000	500C253T160FC2D	9.2	26.40	3 1/2 x 4 1/8	16000	500C163T200FG2B	14.8	20.20	3 x 5 1/8
28000	500C283T160DF2D	6.5	31.40	3 x 5 5/8	18000	500C183T200DF2B	13.3	22.00	3 x 5 5/8
29000	500C293T160DP2D	6.2	32.60	3 x 5 7/8	19000	500C193T200DP2B	15.3	20.70	3 x 5 7/8
29000	500C293T160FD2D	7.9	29.50	3 1/2 x 4 5/8	20000	500C203T200FD2B	12.7	23.30	3 1/2 x 4 5/8
34000	500C343T160FE2D	6.9	32.40	3 1/2 x 5 1/8	21000	500C213T200FE2D	13.4	23.30	3 1/2 x 5 1/8
38000	500C383T160FF2D	6.2	35.10	3 1/2 x 5 5/8	24000	500C243T200FF2D	12.0	25.30	3 1/2 x 5 5/8
40000	500C403T160FP2D	5.9	36.50	3 1/2 x 5 7/8	25000	500C253T200FP2D	11.5	26.30	3 1/2 x 5 7/8
41000	500C413T160DN2D	5.1	39.80	3 x 7 5/8	26000	500C263T200DN2B	11.7	26.40	3 x 7 5/8
47000	500C473T160DG2D	4.3	44.00	3 x 8 5/8	31000	500C313T200DG2B	9.6	29.60	3 x 8 5/8
56000	500C563T160FN2D	4.9	44.30	3 1/2 x 7 5/8	35000	500C353T200FN2D	9.3	32.10	3 1/2 x 7 5/8
65000	500C653T160FG2D	4.2	48.80	3 1/2 x 8 5/8	40000	500C403T200FG2D	7.9	35.50	3 1/2 x 8 5/8
200 Vdc (250 Vdc Surge)					250 Vdc (300 Vdc Surge)				
540	500C541T200AK2B	206.0	2.30	1 3/8 x 1 5/8	380	500C381T250AK2B	260.0	2.00	1 3/8 x 1 5/8
770	500C771T200AA2B	140.0	3.00	1 3/8 x 2 1/8	680	500C681T250AA2B	156.0	2.90	1 3/8 x 2 1/8
970	500C971T200AH2B	101.0	3.90	1 3/8 x 2 5/8	830	500C831T250AH2B	119.0	3.50	1 3/8 x 2 5/8
1400	500C142T200AB2B	78.5	4.60	1 3/8 x 3 1/8	1100	500C112T250AB2B	87.5	4.40	1 3/8 x 3 1/8
1500	500C152T200EA2B	79.1	4.70	1 3/4 x 2 1/8	1100	500C112T250EA2B	99.1	4.20	1 3/4 x 2 1/8
1600	500C162T200BA2B	82.0	5.00	2 x 2 1/8	1200	500C122T250BA2B	94.6	4.60	2 x 2 1/8
1700	500C172T200AJ2B	63.9	5.40	1 3/8 x 3 5/8	1300	500C132T250EH2B	82.8	4.90	1 3/4 x 2 5/8
1700	500C172T200EH2B	62.5	5.70	1 3/4 x 2 5/8	1400	500C142T250AJ2B	69.5	5.20	1 3/8 x 3 5/8

Type 500C 95 °C Long-Life, Screw Terminal, Aluminum Electrolytic

Cap. (µF)	Catalog Part Number	ESR Max. @ 25 °C 120 Hz (mΩ)	Ripple Max. @ 85°C 120 Hz (A)	Nominal Size D x L (inches)	Cap. (µF)	Catalog Part Number	ESR Max. @ 25 °C 120 Hz (mΩ)	Ripple Max. @ 85°C 120 Hz (A)	Nominal Size D x L (inches)
1700	500C172T250AC2B	57.8	6.00	1 3/8 x 4 1/8	1300	500C132T300AC2B	90.4	4.80	1 3/8 x 4 1/8
1700	500C172T250BH2B	65.7	6.00	2 x 2 5/8	1300	500C132T300BH2B	103.0	4.80	2 x 2 5/8
1800	500C182T250EB2B	61.1	6.10	1 3/4 x 3 1/8	1400	500C142T300EB2B	84.5	5.20	1 3/4 x 3 1/8
2000	500C202T250AD2B	51.5	6.60	1 3/8 x 4 5/8	1600	500C162T300AD2B	77.4	5.40	1 3/8 x 4 5/8
2300	500C232T250AE2B	44.1	7.40	1 3/8 x 5 1/8	1800	500C182T300AE2B	65.7	6.10	1 3/8 x 5 1/8
2300	500C232T250EJ2B	48.5	7.20	1 3/4 x 3 5/8	1800	500C182T300EJ2B	68.3	6.10	1 3/4 x 3 5/8
2400	500C242T250BB2B	46.2	7.60	2 x 3 1/8	1900	500C192T300BB2B	71.1	6.10	2 x 3 1/8
2600	500C262T250AF2B	38.4	8.30	1 3/8 x 5 5/8	2000	500C202T300AF2B	60.3	6.60	1 3/8 x 5 5/8
2600	500C262T250CH2B	51.6	7.80	2 1/2 x 2 5/8	2200	500C222T300EC2B	56.7	7.00	1 3/4 x 4 1/8
2800	500C282T250EC2B	40.4	8.30	1 3/4 x 4 1/8	2200	500C222T300CH2B	60.5	7.20	2 1/2 x 2 5/8
3100	500C312T250BJ2B	38.1	8.80	2 x 3 5/8	2400	500C242T300BJ2B	55.5	7.30	2 x 3 5/8
3300	500C332T250ED2B	34.7	9.30	1 3/4 x 4 5/8	2600	500C262T300ED2B	48.5	7.90	1 3/4 x 4 5/8
3700	500C372T250CB2B	32.0	10.50	2 1/2 x 3 1/8	2900	500C292T300BC2B	45.7	8.40	2 x 4 1/8
3800	500C382T250EE2B	30.5	10.30	1 3/4 x 5 1/8	2900	500C292T300CB2B	46.5	8.70	2 1/2 x 3 1/8
3800	500C382T250BC2B	31.4	10.10	2 x 4 1/8	3000	500C302T300EE2B	42.5	8.70	1 3/4 x 5 1/8
4300	500C432T250EF2B	27.3	11.20	1 3/4 x 5 5/8	3400	500C342T300EF2B	37.9	9.50	1 3/4 x 5 5/8
4500	500C452T250BD2B	26.9	11.40	2 x 4 5/8	3500	500C352T300BD2B	38.9	9.50	2 x 4 5/8
4700	500C472T250CJ2B	25.0	12.40	2 1/2 x 3 5/8	3700	500C372T300CJ2B	38.1	10.10	2 1/2 x 3 5/8
5200	500C522T250BE2B	23.6	12.60	2 x 5 1/8	4000	500C402T300BE2B	34.0	10.50	2 x 5 1/8
5600	500C562T250DB2B	27.6	12.60	3 x 3 1/8	4100	500C412T300DB2B	42.8	10.10	3 x 3 1/8
5800	500C582T250CC2B	20.7	14.30	2 1/2 x 4 1/8	4500	500C452T300BF2B	30.2	11.50	2 x 5 5/8
5900	500C592T250BF2B	21.0	13.80	2 x 5 5/8	4500	500C452T300CC2B	29.9	11.90	2 1/2 x 4 1/8
6900	500C692T250CD2B	17.7	16.10	2 1/2 x 4 5/8	5200	500C522T300DJ2B	34.0	11.90	3 x 3 5/8
7200	500C722T250DJ2B	21.6	15.00	3 x 3 5/8	5300	500C532T300CD2B	25.5	13.40	2 1/2 x 4 5/8
7900	500C792T250CE2B	15.5	17.70	2 1/2 x 5 1/8	6100	500C612T300CE2B	22.2	14.80	2 1/2 x 5 1/8
8800	500C882T250DC2B	17.6	17.30	3 x 4 1/8	6400	500C642T300DC2B	26.2	14.20	3 x 4 1/8
9000	500C902T250CF2B	13.8	19.40	2 1/2 x 5 5/8	6900	500C692T300CF2B	19.8	16.20	2 1/2 x 5 5/8
10000	500C103T250DD2B	16.3	18.60	3 x 4 5/8	7500	500C752T300DD2B	23.6	15.50	3 x 4 5/8
11000	500C113T250FC2D	19.5	18.10	3 1/2 x 4 1/8	8700	500C872T300DE2B	20.5	17.20	3 x 5 1/8
12000	500C123T250DE2B	14.3	20.60	3 x 5 1/8	8900	500C892T300FC2D	21.0	17.40	3 1/2 x 4 1/8
13000	500C133T250FD2D	17.2	19.90	3 1/2 x 4 5/8	9800	500C982T300DF2B	18.0	18.90	3 x 5 5/8
14000	500C143T250DF2B	12.0	23.20	3 x 5 5/8	10000	500C103T300DP2B	17.0	19.70	3 x 5 7/8
15000	500C153T250DP2B	11.5	23.90	3 x 5 7/8	10000	500C103T300FD2D	18.2	19.40	3 1/2 x 4 5/8
15000	500C153T250FE2D	15.1	22.00	3 1/2 x 5 1/8	12000	500C123T300FE2D	16.0	21.30	3 1/2 x 5 1/8
17000	500C173T250FF2D	13.2	24.20	3 1/2 x 5 5/8	13000	500C133T300FF2D	14.3	23.20	3 1/2 x 5 5/8
18000	500C183T250FP2D	12.8	24.80	3 1/2 x 5 7/8	14000	500C143T300FP2D	13.5	24.20	3 1/2 x 5 7/8
21000	500C213T250DN2D	9.6	30.90	3 x 7 5/8	15000	500C153T300DN2B	13.2	24.90	3 x 7 5/8
24000	500C243T250DG2D	7.0	34.60	3 x 8 5/8	17000	500C173T300DG2B	10.8	27.90	3 x 8 5/8
25000	500C253T250FN2D	10.5	30.00	3 1/2 x 7 5/8	19000	500C193T300FN2D	11.0	29.50	3 1/2 x 7 5/8
29000	500C293T250FG2D	9.2	33.00	3 1/2 x 8 5/8	22000	500C223T300FG2D	9.3	32.60	3 1/2 x 8 5/8
300 Vdc (350 Vdc Surge)					350 Vdc (400 Vdc Surge)				
290	500C291T300AK2B	418.0	1.60	1 3/8 x 1 5/8	200	500C201T350AK2B	605.0	1.30	1 3/8 x 1 5/8
520	500C521T300AA2B	231.0	2.30	1 3/8 x 2 1/8	320	500C321T350AA2B	379.0	1.80	1 3/8 x 2 1/8
630	500C631T300AH2B	189.0	2.80	1 3/8 x 2 5/8	470	500C471T350AH2B	253.0	2.40	1 3/8 x 2 5/8
870	500C871T300AB2B	138.0	3.50	1 3/8 x 3 1/8	630	500C631T350AB2B	190.0	3.00	1 3/8 x 3 1/8
870	500C871T300EA2B	139.0	3.50	1 3/4 x 2 1/8	720	500C721T350EA2B	177.0	3.10	1 3/4 x 2 1/8
1000	500C102T300BA2B	131.0	3.90	2 x 2 1/8	770	500C771T350EH2B	162.0	3.50	1 3/4 x 2 5/8
1100	500C112T300AJ2B	107.0	4.20	1 3/8 x 3 5/8	790	500C791T350AJ2B	153.0	3.50	1 3/8 x 3 5/8
1100	500C112T300EH2B	117.0	4.10	1 3/4 x 2 5/8	790	500C791T350BA2B	168.0	3.50	2 x 2 1/8

Type 500C 95 °C Long-Life, Screw Terminal, Aluminum Electrolytic

Cap. (µF)	Catalog Part Number	ESR Max. @ 25 °C 120 Hz (mΩ)	Ripple Max. @ 85 °C 120 Hz (A)	Nominal Size D x L (inches)	Cap. (µF)	Catalog Part Number	ESR Max. @ 25 °C 120 Hz (mΩ)	Ripple Max. @ 85 °C 120 Hz (A)	Nominal Size D x L (inches)
950	500C951T350AC2B	127.0	4.00	1 3/8 x 4 1/8	750	500C751T400AC2B	137.0	3.90	1 3/8 x 4 1/8
970	500C971T350BH2B	132.0	4.20	2 x 2 5/8	780	500C781T400BH2B	142.0	4.10	2 x 2 5/8
990	500C991T350EB2B	125.0	4.30	1 3/4 x 3 1/8	790	500C791T400EB2B	134.0	4.10	1 3/4 x 3 1/8
1100	500C112T350AD2B	110.0	4.50	1 3/8 x 4 5/8	880	500C881T400AD2B	118.0	4.40	1 3/8 x 4 5/8
1300	500C132T350AE2B	96.3	5.00	1 3/8 x 5 1/8	1000	500C102T400AE2B	104.0	4.90	1 3/8 x 5 1/8
1300	500C132T350EJ2B	97.3	5.10	1 3/4 x 3 5/8	1000	500C102T400EJ2B	105.0	4.90	1 3/4 x 3 5/8
1300	500C132T350BB2B	101.0	5.10	2 x 3 1/8	1000	500C102T400BB2B	109.0	5.00	2 x 3 1/8
1400	500C142T350AF2B	85.9	5.50	1 3/8 x 5 5/8	1100	500C112T400AF2B	92.4	5.30	1 3/8 x 5 5/8
1500	500C152T350CH2B	86.9	6.00	2 1/2 x 2 5/8	1200	500C122T400EC2B	85.8	5.70	1 3/4 x 4 1/8
1600	500C162T350EC2B	79.9	5.90	1 3/4 x 4 1/8	1200	500C122T400CH2B	93.1	5.80	2 1/2 x 2 5/8
1600	500C162T350BJ2B	79.2	6.10	2 x 3 5/8	1300	500C132T400BJ2B	85.0	5.90	2 x 3 5/8
1800	500C182T350ED2B	67.8	6.60	1 3/4 x 4 5/8	1500	500C152T400ED2B	72.9	6.40	1 3/4 x 4 5/8
2000	500C202T350BC2B	65.1	7.00	2 x 4 1/8	1600	500C162T400BC2B	69.8	6.80	2 x 4 1/8
2100	500C212T350EE2B	59.1	7.40	1 3/4 x 5 1/8	1700	500C172T400EE2B	63.4	7.10	1 3/4 x 5 1/8
2100	500C212T350CB2B	61.0	7.60	2 1/2 x 3 1/8	1700	500C172T400CB2B	65.3	7.30	2 1/2 x 3 1/8
2300	500C232T350BD2B	55.4	8.00	2 x 4 5/8	1900	500C192T400EF2B	56.2	7.80	1 3/4 x 5 5/8
2400	500C242T350EF2B	52.4	8.10	1 3/4 x 5 5/8	1900	500C192T400BD2B	59.3	7.70	2 x 4 5/8
2700	500C272T350BE2B	48.3	8.80	2 x 5 1/8	2100	500C212T400BE2B	51.7	8.50	2 x 5 1/8
2700	500C272T350CJ2B	48.5	8.90	2 1/2 x 3 5/8	2100	500C212T400CJ2B	52.0	8.60	2 1/2 x 3 5/8
2900	500C292T350DB2B	54.0	9.00	3 x 3 1/8	2300	500C232T400DB2B	57.5	8.80	3 x 3 1/8
3100	500C312T350BF2B	42.8	9.70	2 x 5 5/8	2400	500C242T400BF2B	45.9	9.30	2 x 5 5/8
3300	500C332T350CC2B	39.9	10.30	2 1/2 x 4 1/8	2600	500C262T400CC2B	42.8	9.90	2 1/2 x 4 1/8
3700	500C372T350DJ2B	41.7	10.80	3 x 3 5/8	3000	500C302T400DJ2B	44.9	10.40	3 x 3 5/8
3900	500C392T350CD2B	34.0	11.60	2 1/2 x 4 5/8	3100	500C312T400CD2B	35.6	11.30	2 1/2 x 4 5/8
4500	500C452T350CE2B	29.6	12.80	2 1/2 x 5 1/8	3500	500C352T400CE2B	31.7	12.40	2 1/2 x 5 1/8
4600	500C462T350DC2B	34.7	12.30	3 x 4 1/8	3600	500C362T400DC2B	37.0	11.90	3 x 4 1/8
5100	500C512T350CF2B	26.2	14.10	2 1/2 x 5 5/8	4000	500C402T400CF2B	31.5	12.80	2 1/2 x 5 5/8
5400	500C542T350DD2B	29.6	13.90	3 x 4 5/8	4300	500C432T400DD2B	28.1	14.20	3 x 4 5/8
6200	500C622T350DE2B	25.8	15.30	3 x 5 1/8	4900	500C492T400DE2B	27.4	14.80	3 x 5 1/8
6400	500C642T350FC2D	29.9	14.60	3 1/2 x 4 1/8	5100	500C512T400FC2D	31.9	14.10	3 1/2 x 4 1/8
7000	500C702T350DF2B	22.9	16.70	3 x 5 5/8	5600	500C562T400DF2B	24.4	16.20	3 x 5 5/8
7500	500C752T350DP2B	21.7	17.40	3 x 5 7/8	5900	500C592T400DP2B	23.1	16.90	3 x 5 7/8
7500	500C752T350FD2D	25.7	16.30	3 1/2 x 4 5/8	6000	500C602T400FD2D	27.4	15.80	3 1/2 x 4 5/8
8700	500C872T350FE2D	22.5	18.00	3 1/2 x 5 1/8	6900	500C692T400FE2D	23.9	17.50	3 1/2 x 5 1/8
9800	500C982T350FF2D	20.0	19.60	3 1/2 x 5 5/8	7800	500C782T400FF2D	21.2	19.00	3 1/2 x 5 5/8
10000	500C103T350DN2B	17.1	21.80	3 x 7 5/8	8200	500C822T400DN2B	18.2	21.20	3 x 7 5/8
10000	500C103T350FP2D	18.9	20.40	3 1/2 x 5 7/8	8300	500C832T400FP2D	20.1	19.80	3 1/2 x 5 7/8
12000	500C123T350DG2B	14.2	24.30	3 x 8 5/8	9500	500C952T400DG2B	15.1	23.60	3 x 8 5/8
15000	500C153T350FN2D	14.9	25.40	3 1/2 x 7 5/8	11000	500C113T400FN2D	15.8	24.70	3 1/2 x 7 5/8
17000	500C173T350FG2D	12.4	28.30	3 1/2 x 8 5/8	13000	500C133T400FG2D	13.1	27.50	3 1/2 x 8 5/8
400 Vdc (450 Vdc Surge)					450 Vdc (500 Vdc Surge)				
160	500C161T400AK2B	652.0	1.30	1 3/8 x 1 5/8	140	500C141T450AK2B	797.0	1.10	1 3/8 x 1 5/8
250	500C251T400AA2B	408.0	1.80	1 3/8 x 2 1/8	220	500C221T450AA2B	438.0	1.70	1 3/8 x 2 1/8
380	500C381T400AH2B	273.0	2.30	1 3/8 x 2 5/8	330	500C331T450AH2B	337.0	2.10	1 3/8 x 2 5/8
500	500C501T400AB2B	205.0	2.90	1 3/8 x 3 1/8	420	500C421T450EA2B	264.0	2.60	1 3/4 x 2 1/8
570	500C571T400EA2B	189.0	3.00	1 3/4 x 2 1/8	440	500C441T450AB2B	253.0	2.60	1 3/8 x 3 1/8
610	500C611T400EH2B	174.0	3.40	1 3/4 x 2 5/8	520	500C521T450EH2B	213.0	3.10	1 3/4 x 2 5/8
630	500C631T400AJ2B	164.0	3.40	1 3/8 x 3 5/8	550	500C551T450AJ2B	203.0	3.10	1 3/8 x 3 5/8
630	500C631T400BA2B	179.0	3.40	2 x 2 1/8	550	500C551T450BA2B	228.0	3.00	2 x 2 1/8

