



2GB: 256M x 72 / 4GB: 512M x 72 / 8GB: 1G x 72 / 16GB: 2G x 72
PC3-8500 / PC3-10600
Registered DDR3 SDRAM DIMM

Based on DDR3-1066/1333 256Mx8 (2GB/4GB) / 512Mx4 (4GB/8GB) SDRAM B-Die
 Based on DDR3-1066 1Gx4 (DDP) (16GB) SDRAM B-Die

Features

•Performance:

Speed Sort	PC3-8500	PC3-10600	Unit
	-BE	-CG	
DIMM CAS Latency	7	9	
fck – Clock Frequency	533	667	MHz
tck – Clock Cycle	1.875	1.5	ns
fDQ – DQ Burst Frequency	1066	1333	Mbps

- 240-Pin Registered Dual In-Line Memory Module (RDIMM)
- 2GB/4GB: 256Mx72/512Mx72 DDR3 Registered DIMM based on 256Mx8 DDR3 SDRAM B-Die devices
- 4GB/8GB: 512Mx72/1024Mx72 DDR3 Registered DIMM based on 512Mx4 DDR3 SDRAM B-Die devices
- 16GB: 2Gx72 DDR3 Registered DIMM based on 1024Mx4 (DDP) DDR3 SDRAM B-Die devices
- Intended for 533MHz/667MHz applications
- Inputs and outputs are SSTL-15 compatible
- $V_{DD} = V_{DDQ} = 1.5V \pm 0.075V$ (for DDR3)
- $V_{DD} = V_{DDQ} = 1.35V - 0.0675V + 0.1V$ (for DDR3L)
- SDRAMs have 8 internal banks for concurrent operation
- Differential clock inputs
- Data is read or written on both clock edges
- DRAM DLL aligns DQ and DQS transitions with clock transitions.
- Address and control signals are fully synchronous to positive clock edge
- Nominal and Dynamic On-Die Termination support
- Programmable Operation:
 - DIMM \overline{CAS} Latency: 6,7,8,9
 - Burst Type: Sequential or Interleave
 - Burst Length: BC4, BL8
 - Operation: Burst Read and Write
- Two different termination values (Rtt_Nom & Rtt_WR)
- 15/10/1 (row/column/rank) Addressing for 2GB
- 15/11/1 (row/column/rank) Addressing for 4GB (512Mx4 Device)
- 15/10/2 (row/column/rank) Addressing for 4GB (256Mx8 Device)
- 15/11/2 (row/column/rank) Addressing for 8GB
- 15/11/4 (row/column/rank) Addressing for 16GB
- Extended operating temperature range
- Auto Self-Refresh option
- Serial Presence Detect
- Gold contacts
- SDRAMs are in 78-ball BGA Package
- RoHS compliance and Halogen free

Description

NT2GC72B89B0NJ, NT2GC72B89B2NJ, NT2GC72C89B0NJ, NT2GC72C89B2NJ, NT4GC72B4PB0NL, NT4GC72C4PB0NL, NT4GC72C4PB2NL, NT4GC72B8PB0NL, NT4GC72C8PB0NL, NT4GC72C8PB2NL, NT8GC72B4NB1NJ, NT8GC72B4NB3NJ, NT8GC72C4NB1NJ, NT8GC72C4NB3NJ, NT16TC72B4NB1NL, NT16TC72C4NB1NL and NT16TC72C4NB3NL are 240-Pin Double Data Rate 3 (DDR3) Synchronous DRAM Registered Dual In-Line Memory Module, organized as one rank of 256Mx72 (2GB), one rank or two ranks of 512Mx72 (4GB), two ranks of 1Gx72 (8GB) and four ranks of 2Gx72 (16GB) high-speed memory array. Modules use nine 256Mx8 (2GB) 78-ball BGA packaged devices, eighteen 256Mx8 (4GB) 78-ball BGA packaged devices, thirty-six 512Mx4 (8GB) 78-ball BGA packaged devices and thirty-six 1Gx4 (DDP) (16GB) 78-ball BGA packaged devices. These DIMMs are manufactured using raw cards developed for broad industry use as reference designs. The use of these common design files minimizes electrical variation between suppliers. All NANYA DDR3 SDRAM DIMMs provide a high-performance, flexible 8-byte interface in a 5.25" long space-saving footprint.

The DIMM is intended for use in applications operating of 533MHz/667MHz clock speeds and achieves high-speed data transfer rates of 1066Mbps/1333Mbps. Prior to any access operation, the device \overline{CAS} latency and burst/length/operation type must be programmed into the DIMM by address inputs A0-A14 and I/O inputs BA0~BA2 using the mode register set cycle.

The DIMM uses serial presence-detect implemented via a serial EEPROM using a standard IIC protocol. The first 128 bytes of SPD data are programmed and locked during module assembly. The remaining 128 bytes are available for use by the customer.

NT2GC72B89B0NJ/NT2GC72B89B2NJ/NT2GC72C89B0NJ/NT2GC72C89B2NJ
 NT4GC72B4PB0NL/NT4GC72C4PB0NL/NT4GC72C4PB2NL/NT4GC72B8PB0NL/NT4GC72C8PB0NL/NT4GC72C8PB2NL
 NT8GC72B4NB1NJ/NT8GC72B4NB3NJ/NT8GC72C4NB1NJ/NT8GC72C4NB3NJ
 NT16TC72B4NB1NL/NT16TC72C4NB1NL/NT16TC72C4NB3NL



2GB: 256M x 72 / 4GB: 512M x 72 / 8GB: 1G x 72 / 16GB: 2G x 72
PC3-8500 / PC3-10600
Registered DDR3 SDRAM DIMM

Ordering Information

Part Number	Speed			Organization	Power	Leads	Note
NT2GC72B89B0NJ-CG	DDR3-1333	PC3-10600	667MHz (1.5ns @ CL = 9)	256Mx72	1.5V	Gold	
NT2GC72B89B2NJ-CG	DDR3-1333	PC3-10600	667MHz (1.5ns @ CL = 9)				
NT4GC72B4PB0NL-CG	DDR3-1333	PC3-10600	667MHz (1.5ns @ CL = 9)	512Mx72			
NT4GC72B8PB0NL-CG	DDR3-1333	PC3-10600	667MHz (1.5ns @ CL = 9)	1Gx72			
NT8GC72B4NB1NJ-CG	DDR3-1333	PC3-10600	667MHz (1.5ns @ CL = 9)				
NT8GC72B4NB3NJ-CG	DDR3-1333	PC3-10600	667MHz (1.5ns @ CL = 9)				
NT16TC72B4NB1NL-BE	DDR3-1066	PC3-8500	533MHz (1.875ns @ CL = 7)	2Gx72			
NT2GC72C89B0NJ-CG	DDR3L-1333	PC3L-10600	667MHz (1.5ns @ CL = 9)	256Mx72	1.35V		
NT2GC72C89B2NJ-CG	DDR3L-1333	PC3L-10600	667MHz (1.5ns @ CL = 9)				
NT4GC72C4PB0NL-CG	DDR3L-1333	PC3L-10600	667MHz (1.5ns @ CL = 9)	512Mx72			
NT4GC72C4PB2NL-CG	DDR3L-1333	PC3L-10600	667MHz (1.5ns @ CL = 9)				
NT4GC72C8PB0NL-CG	DDR3L-1333	PC3L-10600	667MHz (1.5ns @ CL = 9)				
NT4GC72C8PB2NL-CG	DDR3L-1333	PC3L-10600	667MHz (1.5ns @ CL = 9)				
NT8GC72C4NB1NJ-CG	DDR3L-1333	PC3L-10600	667MHz (1.5ns @ CL = 9)	1Gx72			
NT8GC72C4NB3NJ-CG	DDR3L-1333	PC3L-10600	667MHz (1.5ns @ CL = 9)	2Gx72			
NT16TC72C4NB1NL-BE	DDR3L-1066	PC3L-8500	533MHz (1.875ns @ CL = 7)				
NT16TC72C4NB3NL-BE	DDR3L-1066	PC3L-8500	533MHz (1.875ns @ CL = 7)				

Pin Description

Pin Name	Description	Pin Name	Description
CK0, CK1	Clock Inputs, positive line	ODT0, ODT1	Active termination control lines
$\overline{\text{CK0}}, \overline{\text{CK1}}$	Clock Inputs, negative line	DQ0-DQ63	Data input/output
CKE0, CKE1	Clock Enable	DQS0-DQS17	Data strobes
RAS	Row Address Strobe	$\overline{\text{DQS0}}-\overline{\text{DQS17}}$	Data strobes complement
CAS	Column Address Strobe	TDQS9-TDQS17	Termination data strobes
WE	Write Enable	$\overline{\text{TDQS9}}-\overline{\text{TDQS17}}$	Termination data strobes
S0-S3	Chip Selects	DM0-DM8	Data Masks
A0-A9, A11, A13	Address Inputs	CB0-CB7	ECC Check Bits
A10/AP	Address Input/Auto-Precharge	EVENT	Temperature event pin
A12/BC	Address Input/Burst Chop	RESET	Reset pin
BA0-BA2	SDRAM Bank Address Inputs	V _{REFDQ} , V _{REFCA}	Input/Output Reference
SCL	Serial Presence Detect Clock Input	V _{DDSPD}	SPD and Temp sensor power
SDA	Serial Presence Detect Data input/output	SA0, SA1, SA2	Serial Presence Detect Address Inputs
Par_In	Parity bit for the Address and Control bus	V _{tt}	Termination voltage
Err_Out	Parity error found on the Address and Control bus	V _{ss}	Ground
NC	No Connect	V _{DD}	Core and I/O power



2GB: 256M x 72 / 4GB: 512M x 72 / 8GB: 1G x 72 / 16GB: 2G x 72
PC3-8500 / PC3-10600
Registered DDR3 SDRAM DIMM

DDR3 SDRAM Pin Assignment

Pin	Front	Pin	Back	Pin	Front	Pin	Back	Pin	Front	Pin	Back	Pin	Front	Pin	Back
1	V _{REFDQ}	121	V _{SS}	31	DQ25	151	V _{SS}	61	A2	181	A1	91	DQ41	211	V _{SS}
2	V _{SS}	122	DQ4	32	V _{SS}	152	DM3/DQS12 /TDQS12	62	V _{DD}	182	V _{DD}	92	V _{SS}	212	DM5/DQS14 /TDQS14
3	DQ0	123	DQ5	33	$\overline{\text{DQS}}3$	153	NC/DQS12 /TDQS12	63	NC	183	V _{DD}	93	$\overline{\text{DQS}}5$	213	NC/DQS14 /TDQS14
4	DQ1	124	V _{SS}	34	DQS3	154	V _{SS}	64	NC ⁻	184	CK0	94	DQS5	214	V _{SS}
5	V _{SS}	125	DM0/DQS9 /TDQS9	35	V _{SS}	155	DQ30	65	V _{DD}	185	$\overline{\text{CK}}0$	95	V _{SS}	215	DQ46
6	$\overline{\text{DQS}}0$	126	NC/DQS9 /TDQS9	36	DQ26	156	DQ31	66	V _{DD}	186	V _{DD}	96	DQ42	216	DQ47
7	DQS0	127	V _{SS}	37	DQ27	157	V _{SS}	67	V _{REFCA}	187	$\overline{\text{EVENT}}$	97	DQ43	217	V _{SS}
8	V _{SS}	128	DQ6	38	V _{SS}	158	CB4	68	Par_In/NC	188	A0	98	V _{SS}	218	DQ52
9	DQ2	129	DQ7	39	CB0	159	CB5	69	V _{DD}	189	V _{DD}	99	DQ48	219	DQ53
10	DQ3	130	V _{SS}	40	CB1	160	V _{SS}	70	A10/AP	190	BA1	100	DQ49	220	V _{SS}
11	V _{SS}	131	DQ12	41	V _{SS}	161	DM8/DQS17 /TDQS17	71	BA0	191	V _{DD}	101	V _{SS}	221	DM6/DQS15 /TDQS15
12	DQ8	132	DQ13	42	$\overline{\text{DQS}}8$	162	NC/DQS17 /TDQS17	72	V _{DD}	192	$\overline{\text{RAS}}$	102	$\overline{\text{DQS}}6$	222	NC/DQS15 /TDQS15
13	DQ9	133	V _{SS}	43	DQS8	163	V _{SS}	73	$\overline{\text{WE}}$	193	$\overline{\text{S}}0$	103	DQS6	223	V _{SS}
14	V _{SS}	134	DM1/DQS10 /TDQS10	44	V _{SS}	164	CB6	74	$\overline{\text{CAS}}$	194	V _{DD}	104	V _{SS}	224	DQ54
15	$\overline{\text{DQS}}1$	135	NC/DQS10 /TDQS10	45	CB2	165	CB7	75	V _{DD}	195	ODT0	105	DQ50	225	DQ55
16	DQS1	136	V _{SS}	46	CB3	166	V _{SS}	76	$\overline{\text{S}}1$ /NC	196	A13	106	DQ51	226	V _{SS}
17	V _{SS}	137	DQ14	47	V _{SS}	167	NC	77	ODT1/NC	197	V _{DD}	107	V _{SS}	227	DQ60
18	DQ10	138	DQ15	48	V _{TT} /NC	168	$\overline{\text{RESET}}$	78	V _{DD}	198	$\overline{\text{S}}3$ /NC	108	DQ56	228	DQ61
19	DQ11	139	V _{SS}	49	V _{TT} /NC	169	CKE1/NC	79	$\overline{\text{S}}2$ /NC	199	V _{SS}	109	DQ57	229	V _{SS}
20	V _{SS}	140	DQ20	50	CKE0	170	V _{DD}	80	V _{SS}	200	DQ36	110	V _{SS}	230	DM7/DQS16 /TDQS16
21	DQ16	141	DQ21	51	V _{DD}	171	NC	81	DQ32	201	DQ37	111	$\overline{\text{DQS}}7$	231	NC/DQS16 /TDQS16
22	DQ17	142	V _{SS}	52	BA2	172	NC	82	DQ33	202	V _{SS}	112	DQS7	232	V _{SS}
23	V _{SS}	143	DM2/DQS11 /TDQS11	53	$\overline{\text{Err}}_Out$ /NC	173	V _{DD}	83	V _{SS}	203	DM4/DQS13 /TDQS13	113	V _{SS}	233	DQ62
24	$\overline{\text{DQS}}2$	144	NC/DQS11 /TDQS11	54	V _{DD}	174	A12/BC	84	$\overline{\text{DQS}}4$	204	NC/DQS13 /TDQS13	114	DQ58	234	DQ63
25	DQS2	145	V _{SS}	55	A11	175	A9	85	DQS4	205	V _{SS}	115	DQ59	235	V _{SS}
26	V _{SS}	146	DQ22	56	A7	176	V _{DD}	86	V _{SS}	206	DQ38	116	V _{SS}	236	V _{DDSPD}
27	DQ18	147	DQ23	57	V _{DD}	177	A8	87	DQ34	207	DQ39	117	SA0	237	SA1
28	DQ19	148	V _{SS}	58	A5	178	A6	88	DQ35	208	V _{SS}	118	SCL	238	SDA
29	V _{SS}	149	DQ28	59	A4	179	V _{DD}	89	V _{SS}	209	DQ44	119	SA2	239	V _{SS}
30	DQ24	150	DQ29	60	V _{DD}	180	A3	90	DQ40	210	DQ45	120	V _{TT}	240	V _{TT}

- Note: 1. CKE1, $\overline{\text{S}}1$ and ODT1 are for 2GB/4GB/8GB only.
 2. $\overline{\text{S}}2$ and $\overline{\text{S}}3$ are for 8GB only.
 3. TDQS9-TDQS17 and $\overline{\text{TDQS}}9$ - $\overline{\text{TDQS}}17$ are for 1GB/2GB only.



2GB: 256M x 72 / 4GB: 512M x 72 / 8GB: 1G x 72 / 16GB: 2G x 72
PC3-8500 / PC3-10600
Registered DDR3 SDRAM DIMM

Input/Output Functional Description

Symbol	Type	Polarity	Function
CK0, CK1 $\overline{\text{CK0}}, \overline{\text{CK1}}$	Input	Cross point	The system clock inputs. All address and command lines are sampled on the cross point of the rising edge of CK and falling edge of $\overline{\text{CK}}$. A Delay Locked Loop (DLL) circuit is driven from the clock inputs and output timing for read operations is synchronized to the input clock. However, CK1 and $\overline{\text{CK1}}$ are terminated but not used on RDIMMs.
CKE0, CKE1	Input	Active High	Activates the DDR3 SDRAM CK signal when high and deactivates the CK signal when low. By deactivating the clocks, CKE low initiates the Power Down mode or the Self Refresh mode.
$\overline{\text{S0}} - \overline{\text{S3}}$	Input	Active Low	Enable the command decoders for the associated rank of SDRAM when low and disables decoders when high. When decoders are disabled, new commands are ignored and previous operations continue. Other combinations of these input signals perform unique functions, including disabling all outputs (except CKE and ODT) of the register(s) on the DIMM or accessing internal control words in the register device(s). For modules with two registers, $\overline{\text{S2}}$ and $\overline{\text{S3}}$ operate similarly to $\overline{\text{S0}}$ and $\overline{\text{S1}}$ for the second set of register outputs or register control words.
$\overline{\text{RAS}}, \overline{\text{CAS}}, \overline{\text{WE}}$	Input	Active Low	When sampled at the positive rising edge of CK and falling edge of $\overline{\text{CK}}$, signals $\overline{\text{RAS}}$, $\overline{\text{CAS}}$, $\overline{\text{WE}}$ define the operation to be executed by the SDRAM.
ODT0, ODT1	Input	Active High	Asserts on-die termination for DQ, DM, DQS, and $\overline{\text{DQS}}$ signals if enabled via the DDR3 SDRAM mode register.
DM0 – DM8	Input	Active High	The data write masks, associated with one data byte. In Write mode, DM operates as a byte mask by allowing input data to be written if it is low but blocks the write operation if it is high. In Read mode, DM lines have no effect.
DQS0 – DQS17 $\overline{\text{DQS0}} - \overline{\text{DQS17}}$	I/O	Cross point	The data strobes, associated with one data byte, sourced with data transfers. In Write mode, the data strobe is sourced by the controller and is centered in the data window. In Read mode, the data strobe is sourced by the DDR3 SDRAM and is sent at the leading edge of the data window. $\overline{\text{DQS}}$ signals are complements, and timing is relative to the cross point of respective DQS and $\overline{\text{DQS}}$. If the module is to be operated in single ended strobe mode, all DQS signals must be tied on the system board to V_{SS} and DDR3 SDRAM mode registers programmed appropriately.
TDQS9 – TDQS17 $\overline{\text{TDQS9}} - \overline{\text{TDQS17}}$	Output		TDQS/ $\overline{\text{TDQS}}$ is applicable for x8 DRAMs only. When enabled via mode register A11=1 in MR1, DRAM will enable the same termination resistance function on TDQS/ $\overline{\text{TDQS}}$ that is applied to DQS/ $\overline{\text{DQS}}$. When disabled via mode register A11=0 in MR1, DM/TDQS will provide the data mask function TDQS is not used. X4/x16 DRAMs must disable the TDQS function via mode register A11=0 in MR1.
BA0, BA1, BA2	Input	-	Selects which DDR3 SDRAM internal bank of four or eight is activated.
A0 – A9 A10/AP A11 A12/ $\overline{\text{BC}}$ A13	Input	-	During a Bank Activate command cycle, defines the row address when sampled at the cross point of the rising edge of CK and falling edge of $\overline{\text{CK}}$. During a Read or Write command cycle, defines the column address when sampled at the cross point of the rising edge of CK and falling edge of $\overline{\text{CK}}$. In addition to the column address, AP is used to invoke autoprecharge operation at the end of the burst read or write cycle. If AP is high, autoprecharge is selected and BA0-BAn defines the bank to be precharged. If AP is low, autoprecharge is disabled. During a Precharge command cycle, AP is used in conjunction with BA0-BAn to control which bank(s) to precharge. If AP is high, all banks will be precharged regardless of the state of BA0-BAn inputs. If AP is low, then BA0-BAn are used to define which bank to precharge.
DQ0 – DQ63	Input	-	Data Input/Output pins.
CB0 – CB7	I/O	-	Check bits are used for ECC.
$V_{DD}, V_{DDSPD}, V_{SS}$	Supply	-	Power supplies for core, I/O, Serial Presence Detect, Temp sensor, and ground for the module.
V_{REFDQ}, V_{REFCA}	Supply	-	Reference voltage for SSTL15 inputs.
SDA	I/O	-	This is a bidirectional pin used to transfer data into or out of the SPD EEPROM and temp sensor. A resistor must be connected from the SDA bus line to V_{DDSPD} on the system planar to act as a pull up.
SCL	Input	-	This signal is used to clock data into and out of the SPD EEPROM and Temp sensor.
SA0 – SA2	Input	-	Address pins used to select the Serial Presence Detect and Temp sensor base address.
$\overline{\text{EVENT}}$	Output	-	The $\overline{\text{EVENT}}$ pin is reserved for use to flag critical module temperature.
$\overline{\text{RESET}}$	Input	-	This signal resets the DDR3 SDRAM.
Par_In	Input	-	Parity bit for the Address and Control bus.
$\overline{\text{Err_Out}}$	Output	-	Parity error detected on the Address and Control bus. A resistor may be connected from bus line to V_{DD} on the system planar to act as a pull up.



2GB: 256M x 72 / 4GB: 512M x 72 / 8GB: 1G x 72 / 16GB: 2G x 72
PC3-8500 / PC3-10600
Registered DDR3 SDRAM DIMM

Functional Block Diagram (Part 1 of 2)

[2GB – 1 Rank, 256Mx8 DDR3 SDRAMs]

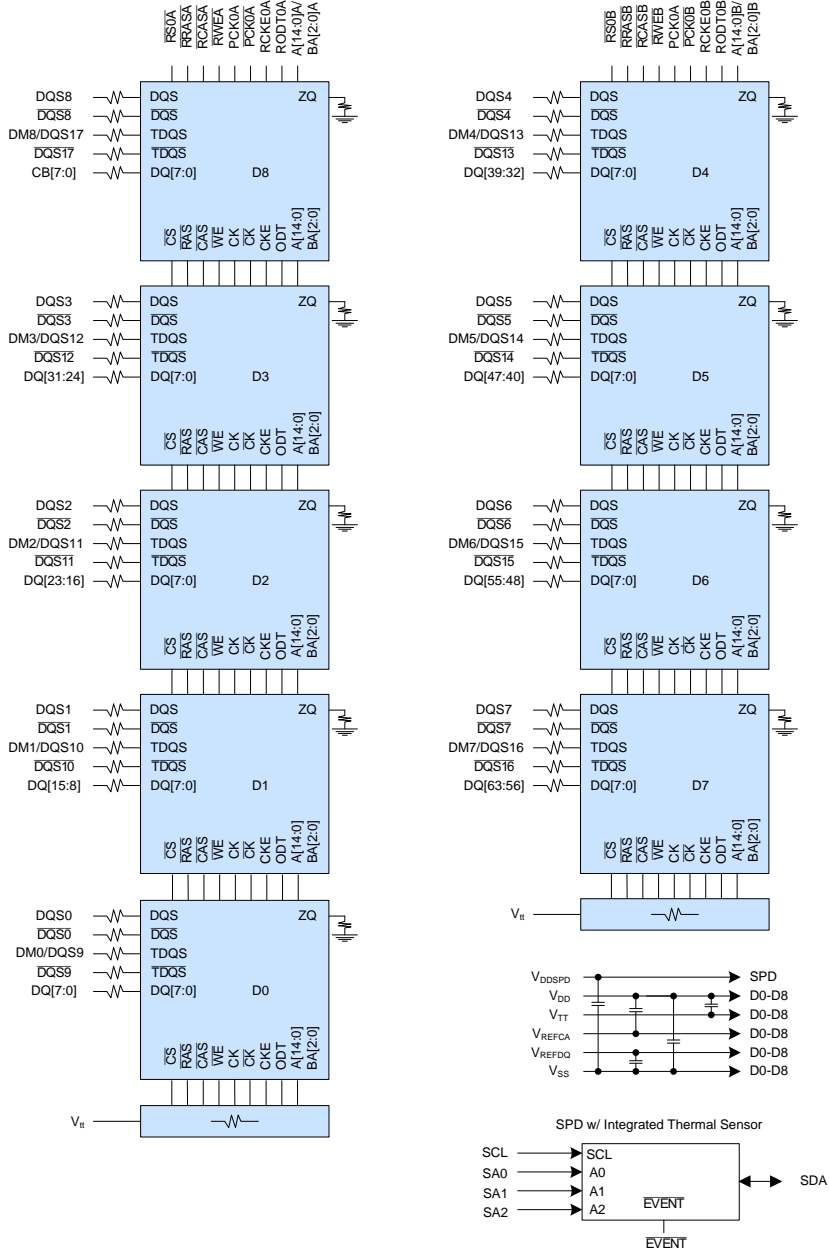

Notes :

1. DQ-to-I/O wiring is shown as recommended but may be changed.
2. ZQ resistors are 240Ω ±1%. For all other resistor values refer to the appropriate wiring diagram.



2GB: 256M x 72 / 4GB: 512M x 72 / 8GB: 1G x 72 / 16GB: 2G x 72
PC3-8500 / PC3-10600
Registered DDR3 SDRAM DIMM

Functional Block Diagram (Part 2 of 2)

[2GB – 1 Rank, 256Mx8 DDR3 SDRAMs]

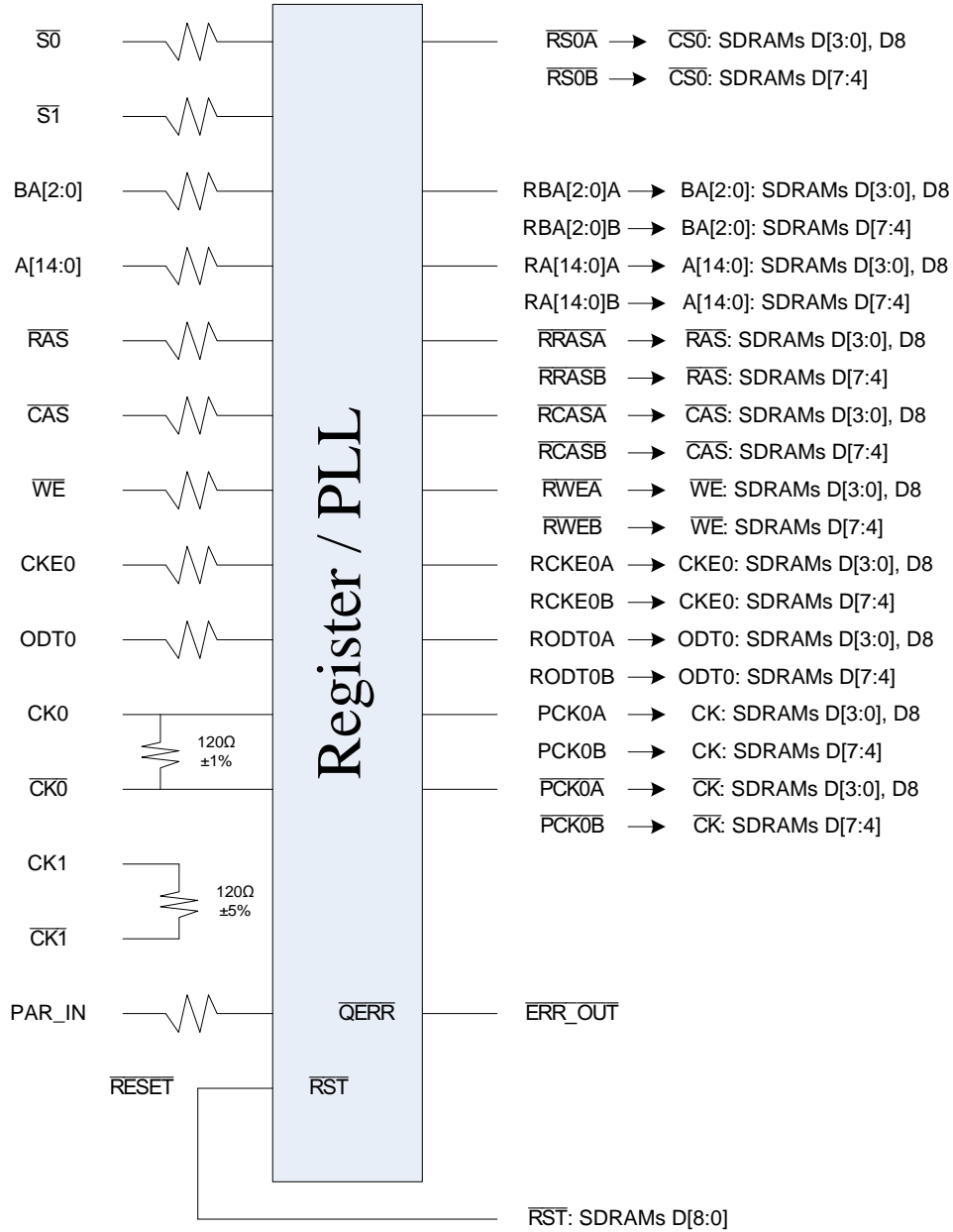

Note: S[3:2], CKE1, ODT1 are NC
 (Unused register inputs ODT1 and CKE1 have a 330Ω resistor to ground)



2GB: 256M x 72 / 4GB: 512M x 72 / 8GB: 1G x 72 / 16GB: 2G x 72
PC3-8500 / PC3-10600
Registered DDR3 SDRAM DIMM

Functional Block Diagram (Part 1 of 2)

[4GB – 2 Ranks, 256Mx8 DDR3 SDRAMs]

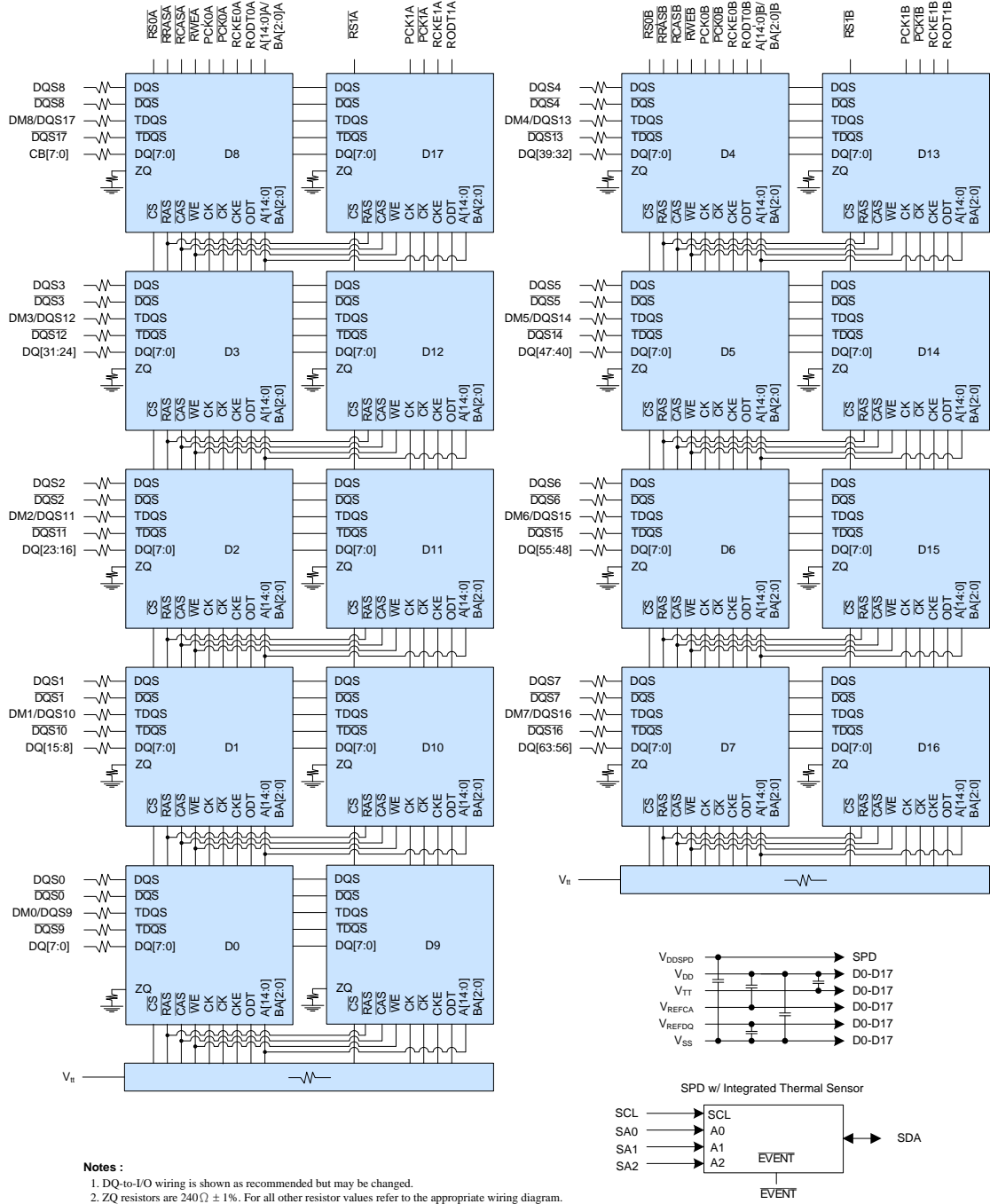

- Notes :**
1. DQ-to-I/O wiring is shown as recommended but may be changed.
 2. ZQ resistors are $240\ \Omega \pm 1\%$. For all other resistor values refer to the appropriate wiring diagram.
 3. Unless otherwise noted, resistor values are $15\ \Omega \pm 5\%$.
 4. See the wiring diagrams for all resistors associated with the command, address and control bus.



2GB: 256M x 72 / 4GB: 512M x 72 / 8GB: 1G x 72 / 16GB: 2G x 72
PC3-8500 / PC3-10600
Registered DDR3 SDRAM DIMM

Functional Block Diagram (Part 2 of 2)

[4GB – 2 Ranks, 256Mx8 DDR3 SDRAMs]

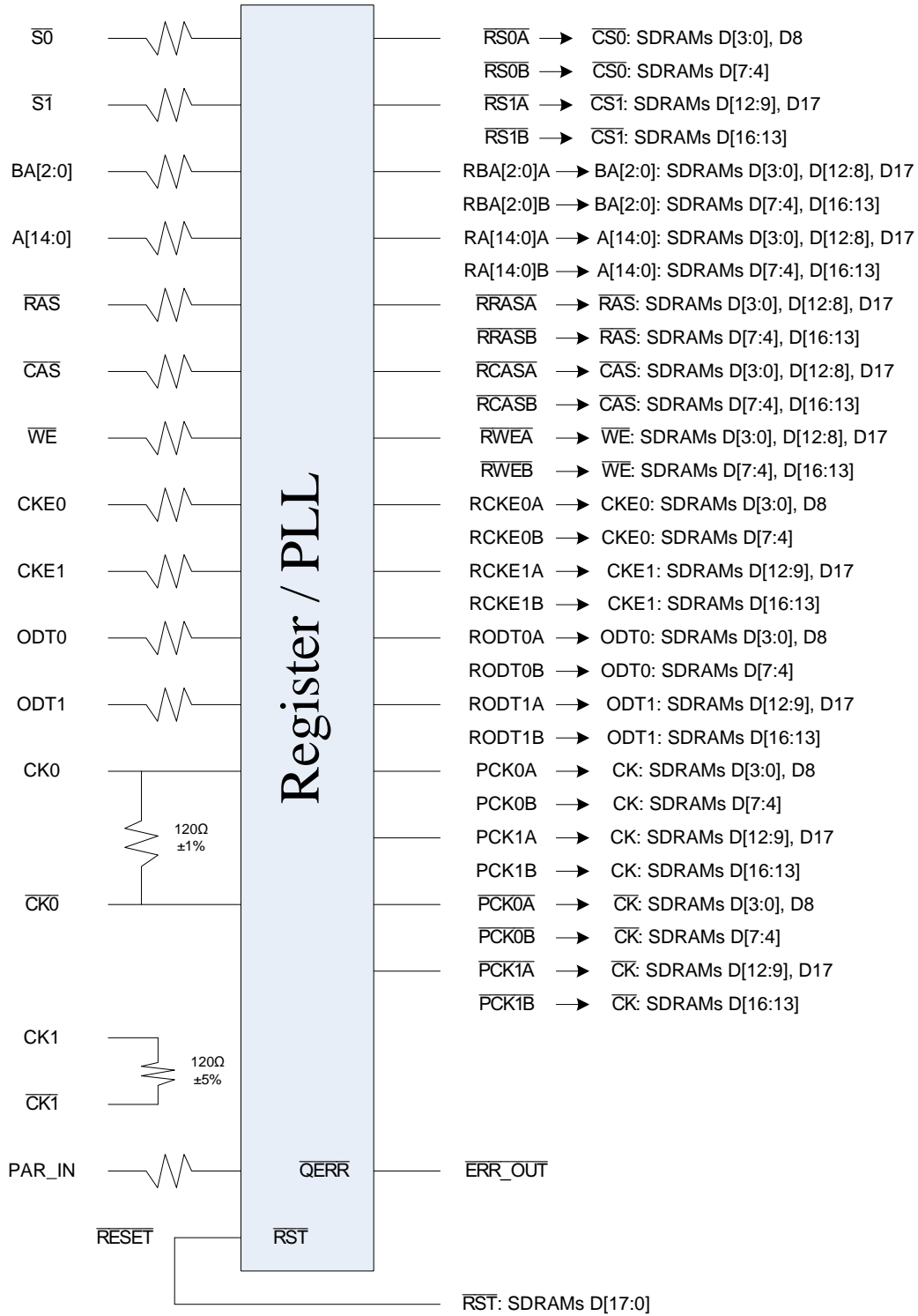



2GB: 256M x 72 / 4GB: 512M x 72 / 8GB: 1G x 72 / 16GB: 2G x 72
PC3-8500 / PC3-10600
Registered DDR3 SDRAM DIMM

Functional Block Diagram (Part 1 of 3)

[4GB – 1 Rank, 512Mx4 DDR3 SDRAMs]

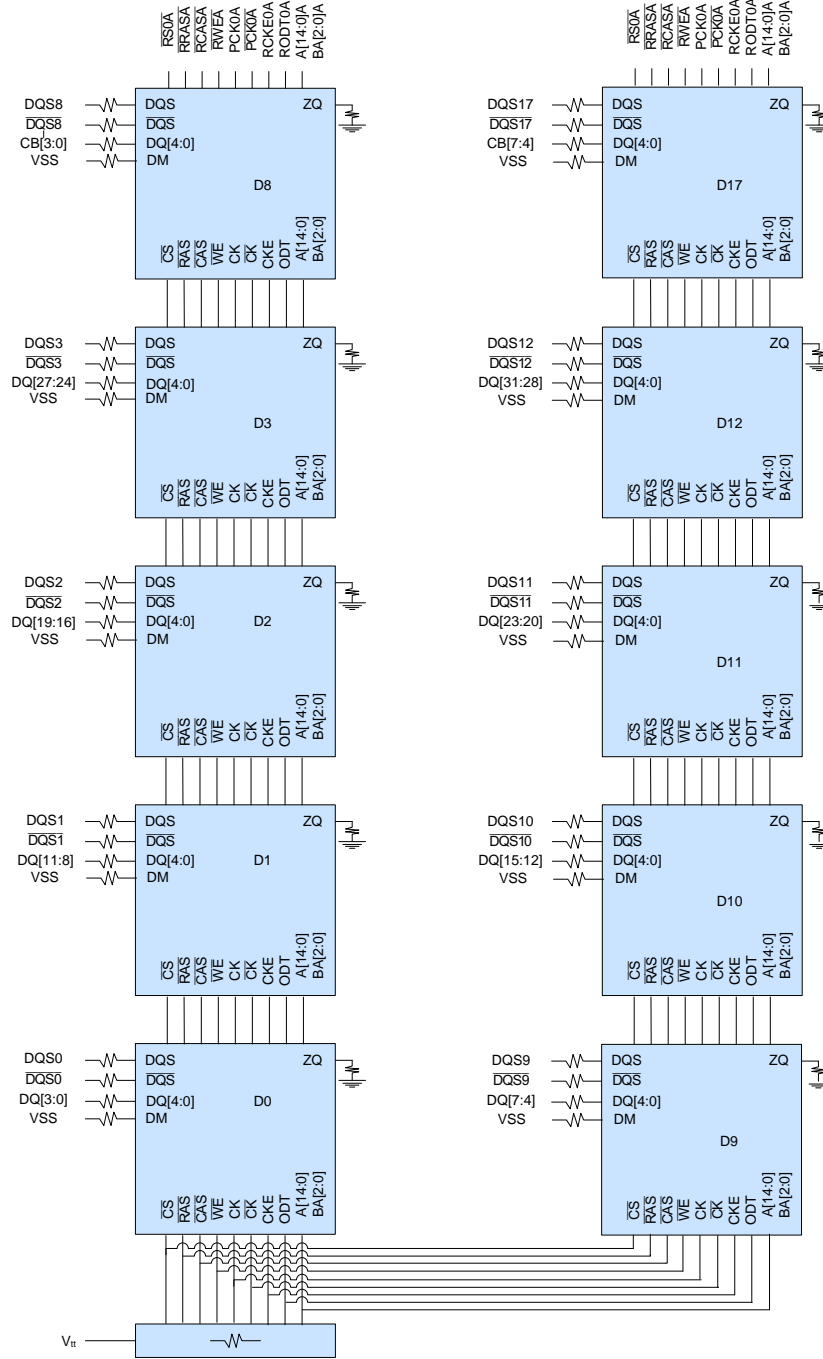



2GB: 256M x 72 / 4GB: 512M x 72 / 8GB: 1G x 72 / 16GB: 2G x 72
PC3-8500 / PC3-10600
Registered DDR3 SDRAM DIMM

Functional Block Diagram (Part 2 of 3)

[4GB – 1 Rank, 512Mx4 DDR3 SDRAMs]

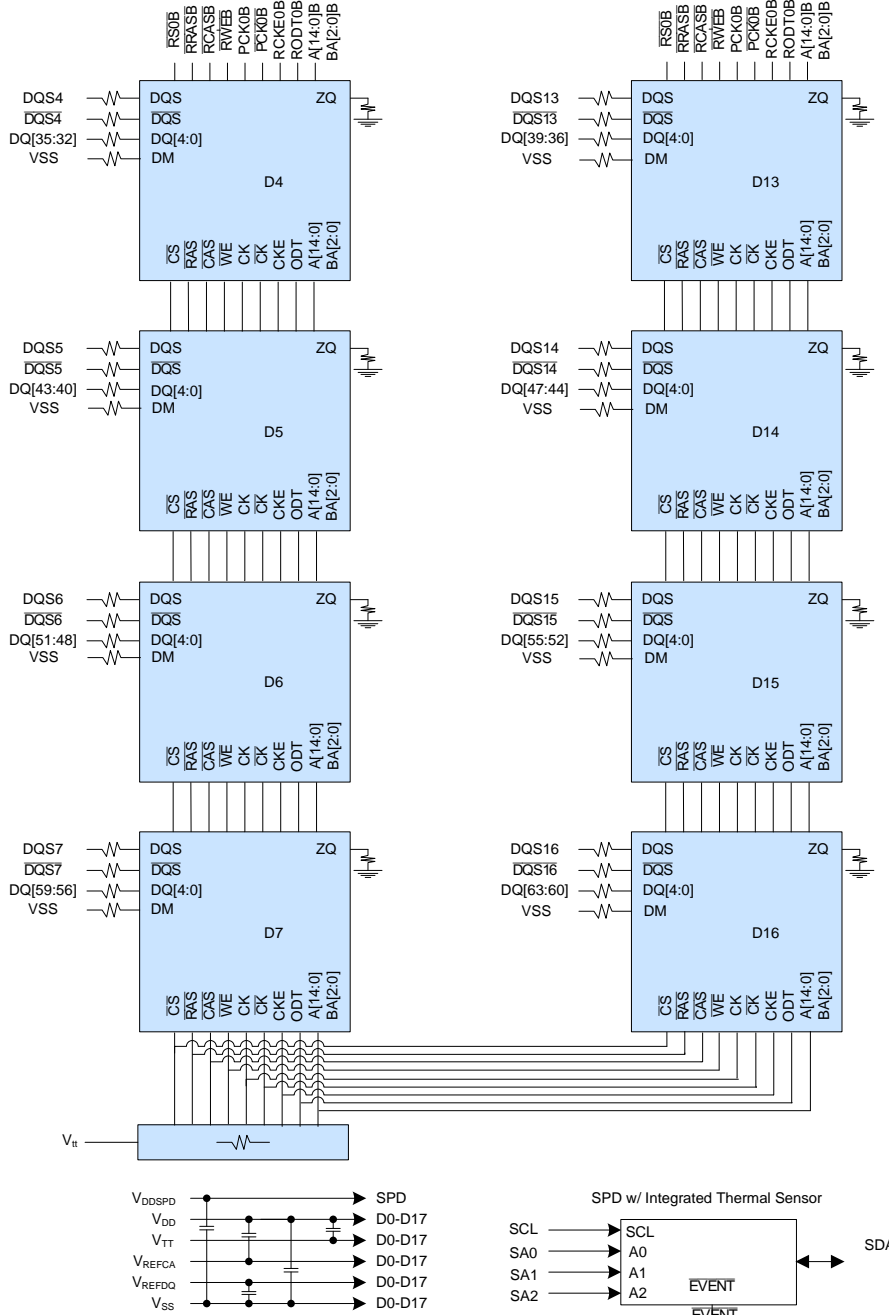

Notes :

1. DQ-to-I/O wiring is shown as recommended but may be changed.
2. ZQ resistors are 240Ω ± 1%. For all other resistor values refer to the appropriate wiring diagram.
3. Unless otherwise noted, resistor values are 15Ω ± 5%.
4. See the wiring diagrams for all resistors associated with the command, address and control bus.



2GB: 256M x 72 / 4GB: 512M x 72 / 8GB: 1G x 72 / 16GB: 2G x 72
PC3-8500 / PC3-10600
Registered DDR3 SDRAM DIMM

Functional Block Diagram (Part 3 of 3)

[4GB – 1 Rank, 512Mx4 DDR3 SDRAMs]

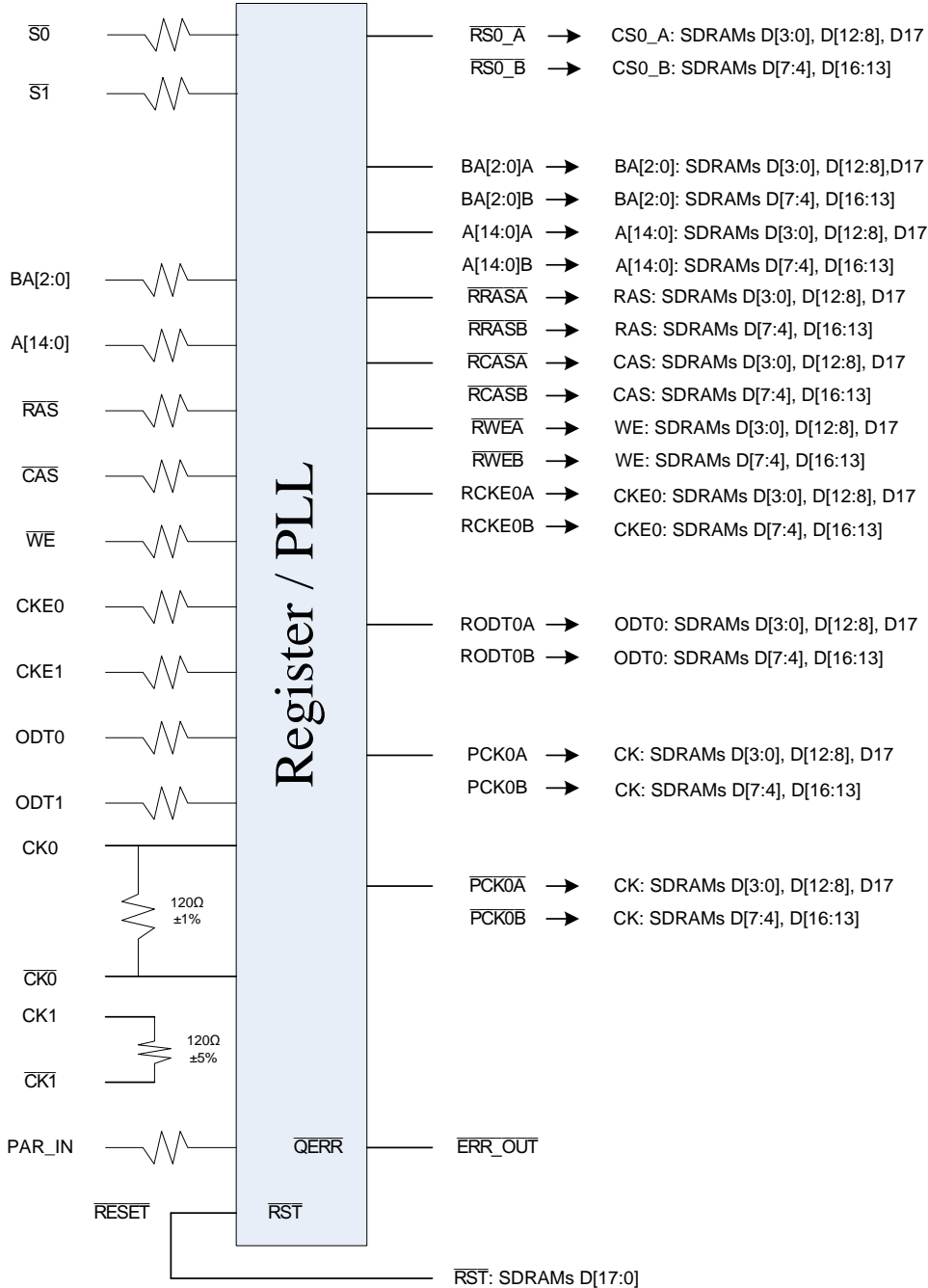



2GB: 256M x 72 / 4GB: 512M x 72 / 8GB: 1G x 72 / 16GB: 2G x 72
PC3-8500 / PC3-10600
Registered DDR3 SDRAM DIMM

Functional Block Diagram (Part 2 of 3)

[8GB — 2 Ranks, 512Mx4 DDR3 SDRAMs]

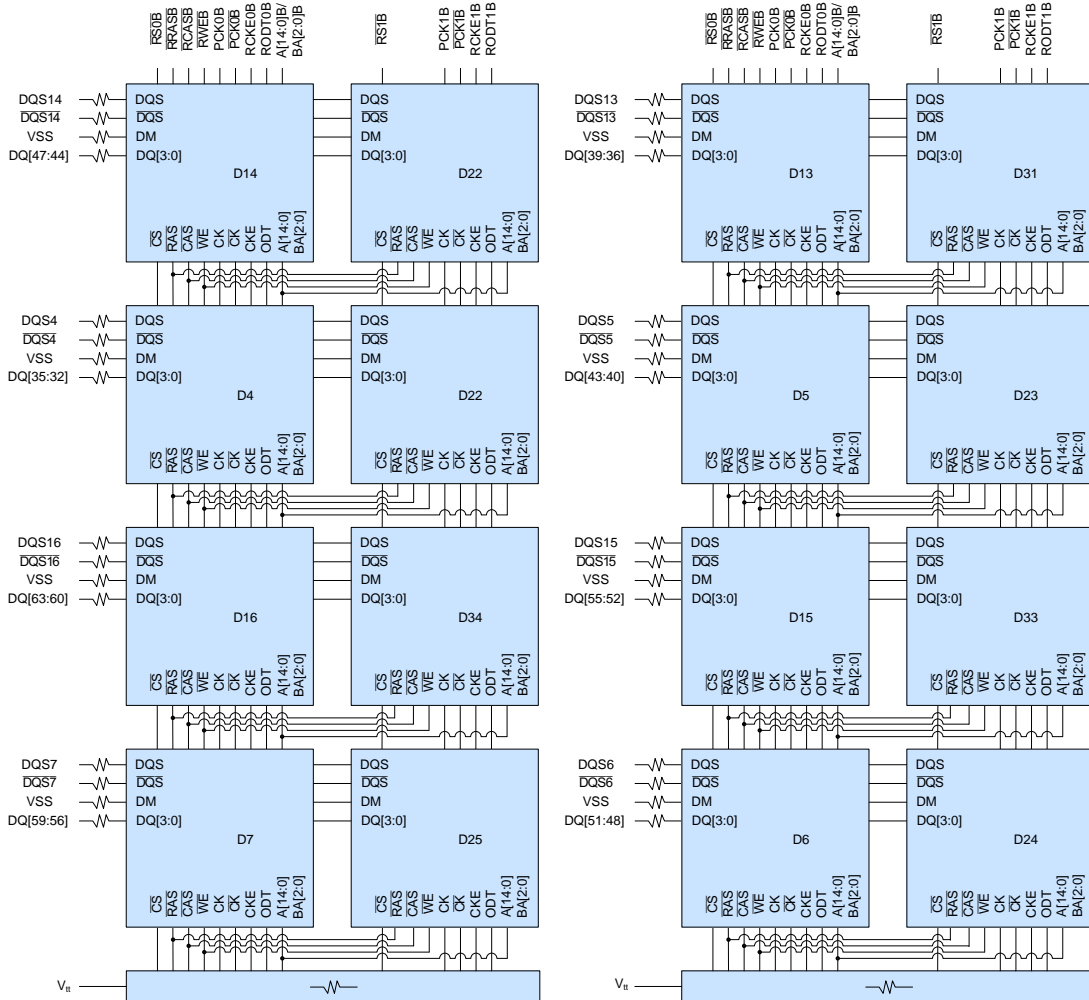

Notes :

1. DQ-to-I/O wiring is shown as recommended but may be changed.
2. ZQ pins of each SDRAM are connected to individual RZQ resistors (240Ω ± 1%).
3. See the wiring diagrams for resistor values.

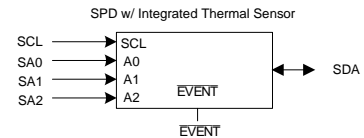
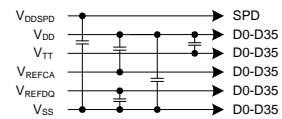



2GB: 256M x 72 / 4GB: 512M x 72 / 8GB: 1G x 72 / 16GB: 2G x 72
PC3-8500 / PC3-10600
Registered DDR3 SDRAM DIMM

Functional Block Diagram (Part 3 of 3)

[8GB – 2 Ranks, 512Mx4 DDR3 SDRAMs]

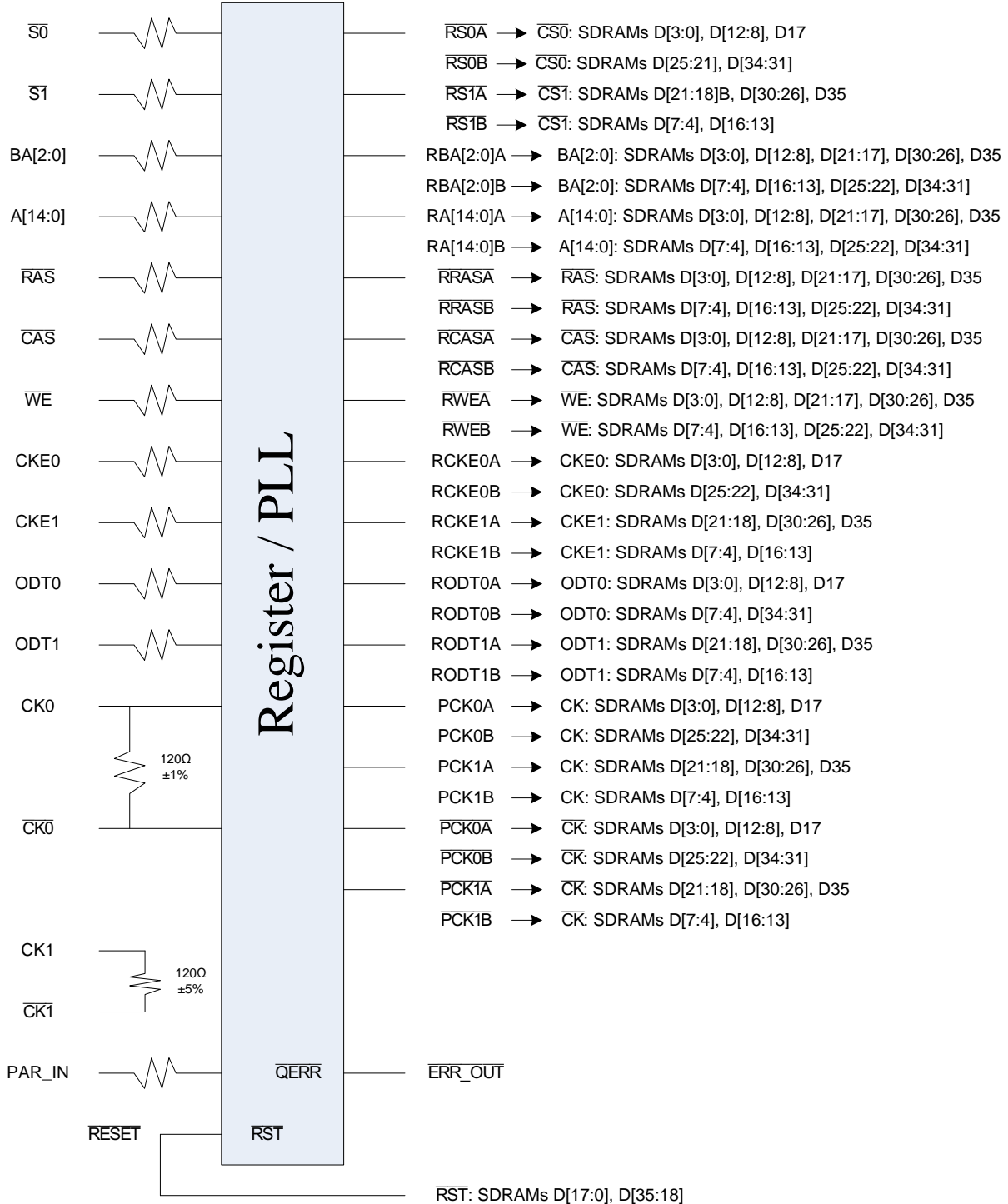



2GB: 256M x 72 / 4GB: 512M x 72 / 8GB: 1G x 72 / 16GB: 2G x 72
PC3-8500 / PC3-10600
Registered DDR3 SDRAM DIMM

Functional Block Diagram (Part 1 of 5)

[16GB – 4 Ranks, 1Gx4 (DDP) DDR3 SDRAMs]

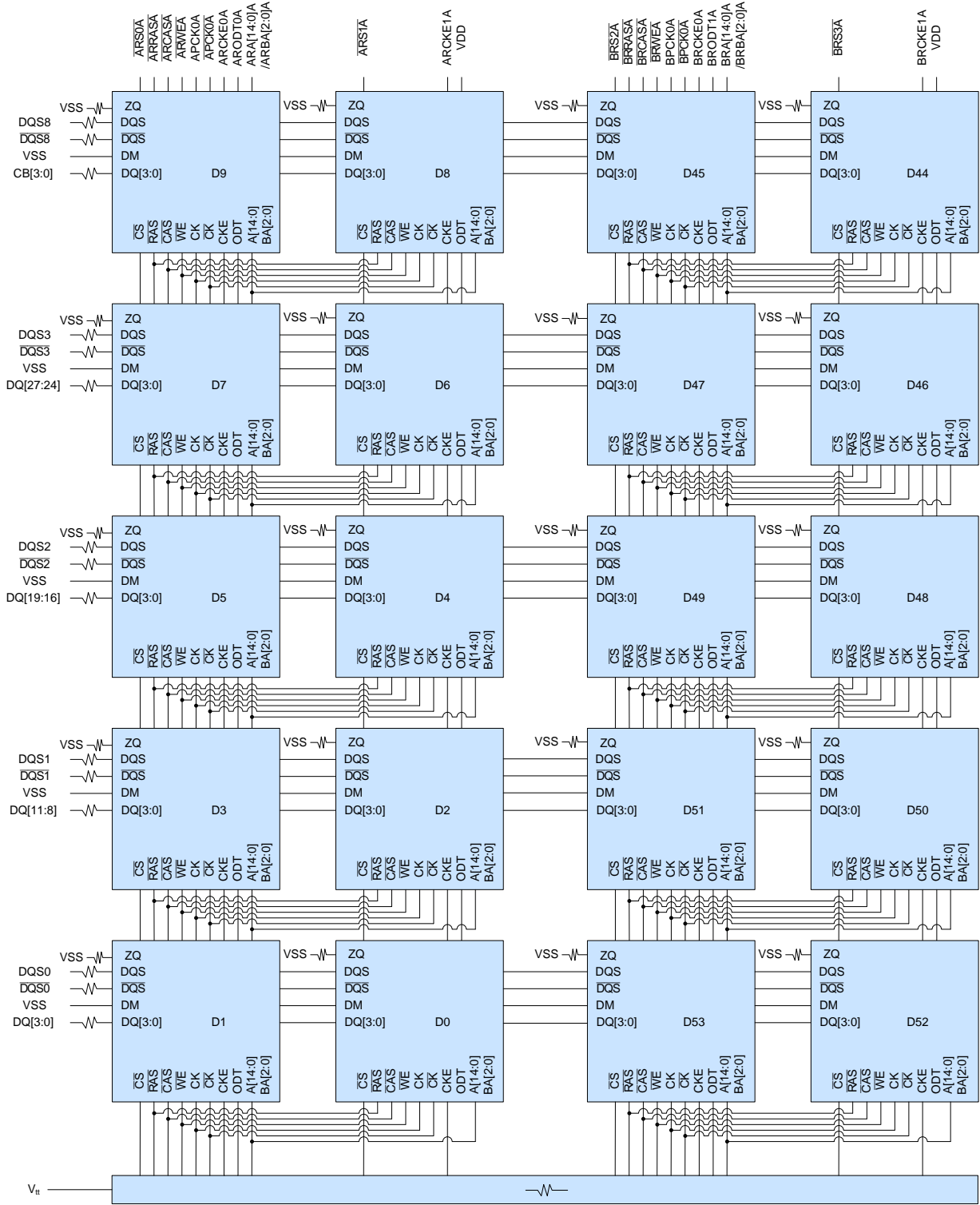



2GB: 256M x 72 / 4GB: 512M x 72 / 8GB: 1G x 72 / 16GB: 2G x 72
PC3-8500 / PC3-10600
Registered DDR3 SDRAM DIMM

Functional Block Diagram (Part 2 of 5)

[16GB – 4 Ranks, 1Gx4 (DDP) DDR3 SDRAMs]

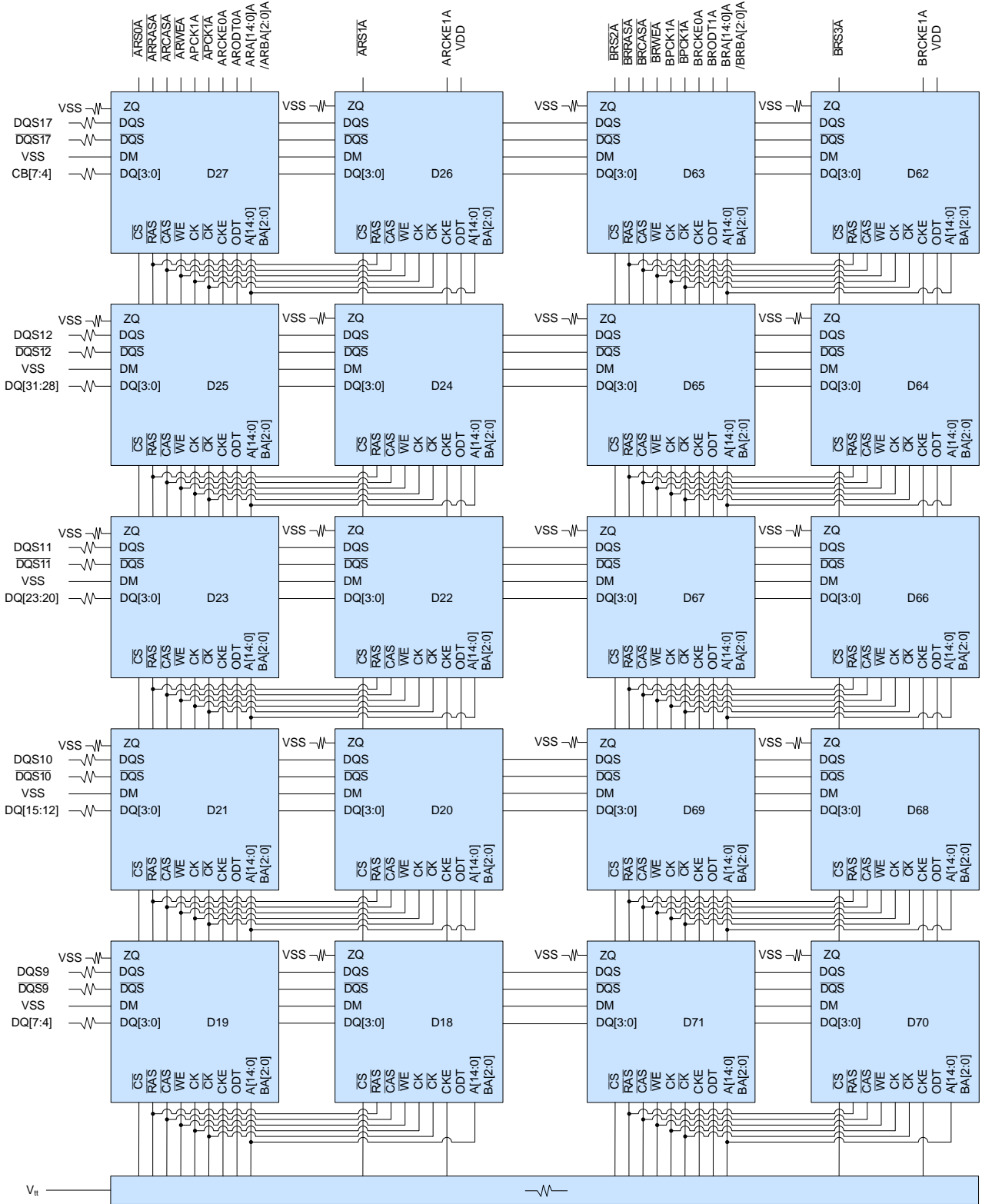



2GB: 256M x 72 / 4GB: 512M x 72 / 8GB: 1G x 72 / 16GB: 2G x 72
PC3-8500 / PC3-10600
Registered DDR3 SDRAM DIMM

Functional Block Diagram (Part 3 of 5)

[16GB – 4 Ranks, 1Gx4 (DDP) DDR3 SDRAMs]

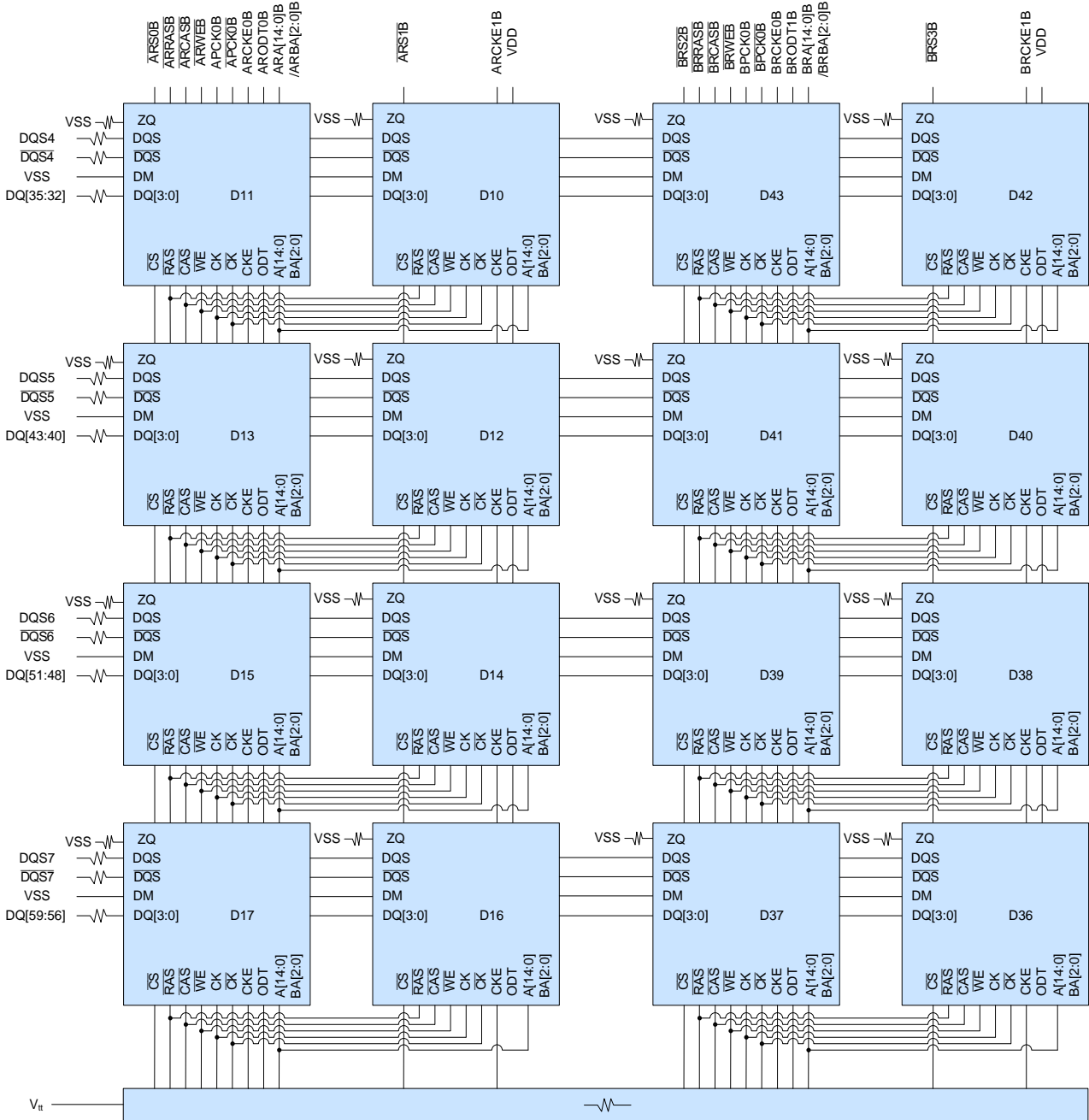



2GB: 256M x 72 / 4GB: 512M x 72 / 8GB: 1G x 72 / 16GB: 2G x 72
PC3-8500 / PC3-10600
Registered DDR3 SDRAM DIMM

Functional Block Diagram (Part 4 of 5)

[16GB – 4 Ranks, 1Gx4 (DDP) DDR3 SDRAMs]

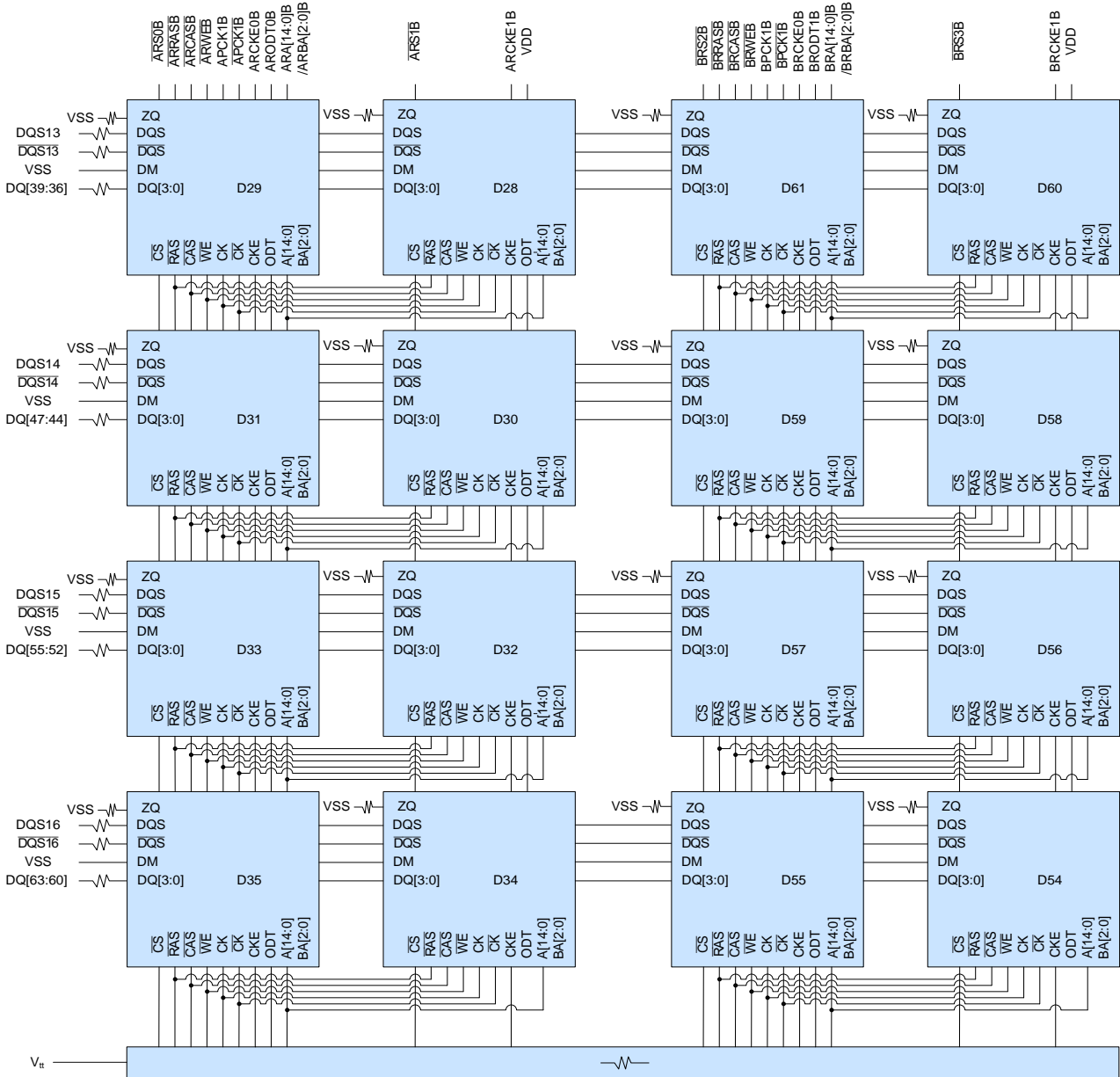

- Notes :**
1. DQ-to-I/O wiring is may be changed within a nibble.
 2. Resistor values are $15\Omega \pm 5\%$.
 3. ZQ resistors are $240\Omega \pm 1\%$.
 3. See the wiring diagrams for resistor values.

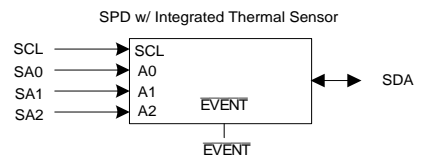
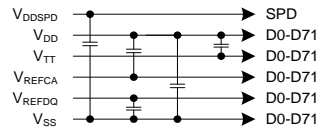



2GB: 256M x 72 / 4GB: 512M x 72 / 8GB: 1G x 72 / 16GB: 2G x 72
PC3-8500 / PC3-10600
Registered DDR3 SDRAM DIMM

Functional Block Diagram (Part 5 of 5)

[16GB – 4 Ranks, 1Gx4 (DDP) DDR3 SDRAMs]

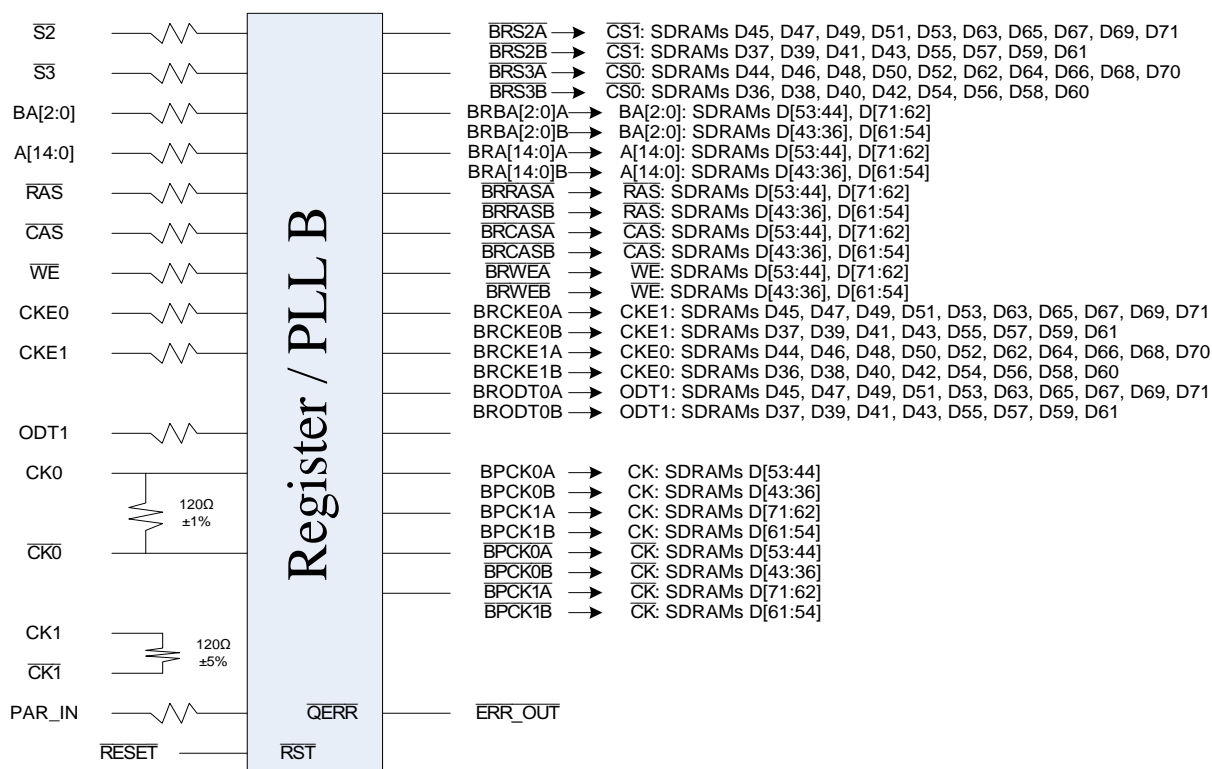
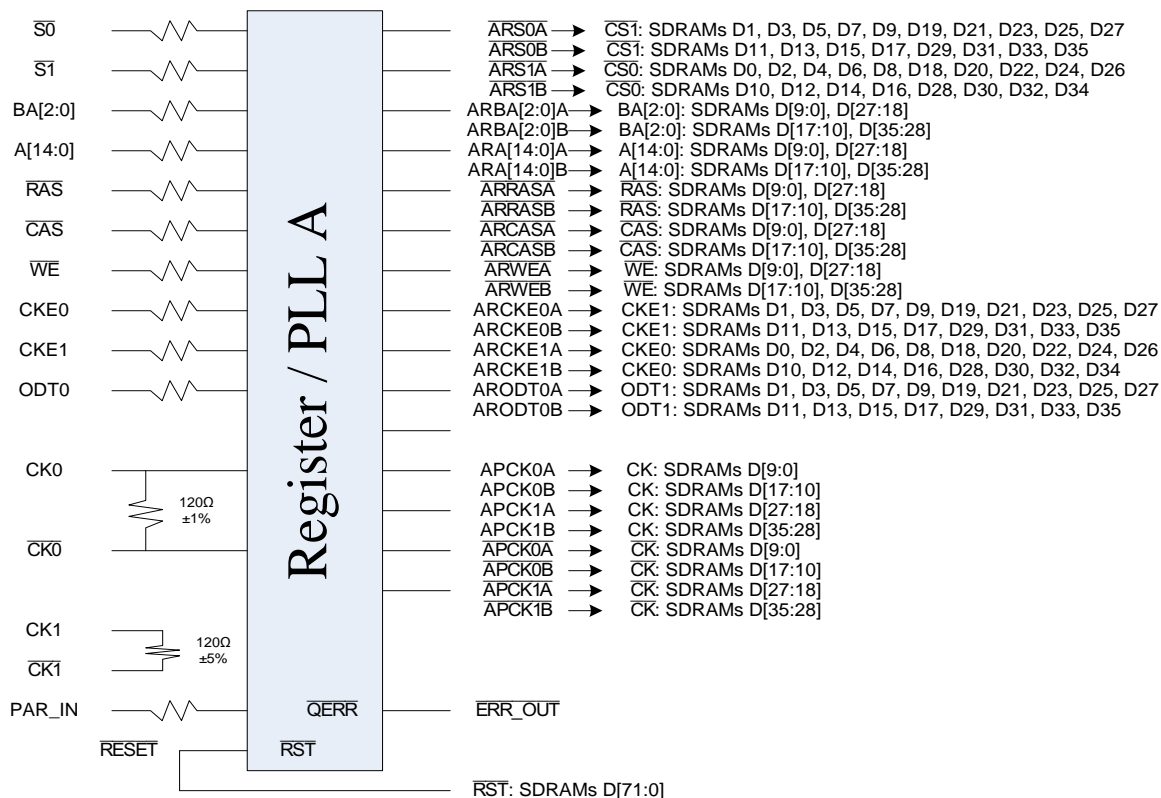



2GB: 256M x 72 / 4GB: 512M x 72 / 8GB: 1G x 72 / 16GB: 2G x 72
PC3-8500 / PC3-10600
Registered DDR3 SDRAM DIMM

Environmental Requirements

Symbol	Parameter	Rating	Units	Note
H _{OPR}	Operating Humidity (relative)	10 to 90	%	1
T _{STG}	Storage Temperature (Plastic)	-55 to 100	°C	1
H _{STG}	Storage Humidity (without condensation)	5 to 95	%	1
P _{BAR}	Barometric Pressure (operating & storage)	105 to 69	K Pascal	1, 2

Note:

- Stresses greater than those listed may cause permanent damage to the device. This is a stress rating only and device functional operation at or above the conditions indicated is not implied. Exposure to absolute maximum rating conditions for extended periods may affect reliability.
- Up to 9850 ft.

Absolute Maximum DC Ratings

Symbol	Parameter	Rating	Units	Note
V _{DD}	Voltage on VDD pins relative to Vss	-0.4 V ~ 1.975 V	V	1, 3
V _{DDQ}	Voltage on VDDQ pins relative to Vss	-0.4 V ~ 1.975 V	V	1, 3
V _{IN} , V _{OUT}	Voltage on I/O pins relative to Vss	-0.4 V ~ 1.975 V	V	1
T _{STG}	Storage Temperature	-55 to +100	°C	1, 2

Note:

- Stresses greater than those listed under "Absolute Maximum Ratings" may cause permanent damage to the device. This is a stress rating only and functional operation of the device at these or any other conditions above those indicated in the operational sections of this specification is not implied. Exposure to absolute maximum rating conditions for extended periods may affect reliability
- Storage Temperature is the case surface temperature on the center/top side of the DRAM.
- VDD and VDDQ must be within 300 mV of each other at all times;and VREF must be not greater

Operating temperature Conditions

Symbol	Parameter	Rating	Units	Note
T _{OPER}	Normal Operating Temperature Range	0 to 85	°C	1, 2
	Extended Temperature Range (Optional)	85 to 95	°C	1, 3

Note:

- Operating Temperature TOPER is the case surface temperature on the center / top side of the DRAM.
- The Normal Temperature Range specifies the temperatures where all DRAM specifications will be supported. During operation, the DRAM case temperature must be maintained between 0 to 85 °C under all operating conditions
- Some applications require operation of the DRAM in the Extended Temperature Range between 85 °C and 95 °C case temperature. Full specifications are supported in this range, but the following additional conditions apply:
 - Refresh commands must be doubled in frequency, therefore reducing the Refresh interval tREFI to 3.9 μs. It is also possible to specify a component with 1X refresh (tREFI to 7.8μs) in the Extended Temperature Range. Please refer to supplier data sheet and/or the DIMM SPD for option availability.
 - If Self-Refresh operation is required in the Extended Temperature Range, then it is mandatory to either use the Manual Self-Refresh mode with Extended Temperature Range capability (MR2 A6 = 0b and MR2 A7 = 1b) or enable the optional Auto Self-Refresh mode (MR2 A6 = 1b and MR2 A7 = 0b). Please refer to the supplier data sheet and/or the DIMM SPD for Auto Self-Refresh option availability, Extended Temperature Range support and tREFI requirements in the Extended Temperature Range.



2GB: 256M x 72 / 4GB: 512M x 72 / 8GB: 1G x 72 / 16GB: 2G x 72
PC3-8500 / PC3-10600
Registered DDR3 SDRAM DIMM

DC Electrical Characteristics and Operating Conditions

Symbol	Parameter	Min	Type	Max	Units	Notes
VDD	Supply Voltage	1.425	1.5	1.575	V	1,2
VDDQ	Output Supply Voltage	1.425	1.5	1.575	V	1,2
VDD	Supply Voltage	1.28	1.35	1.45	V	DDR3L
VDDQ	Output Supply Voltage	1.28	1.35	1.45	V	DDR3L

Note:

- Under all conditions VDDQ must be less than or equal to VDD.
- VDDQ tracks with VDD. AC parameters are measured with VDD and VDDQ tied together.

Single-Ended AC and DC Input Levels for Command and Address

Symbol	Parameter	DDR3-1066 (-BE)		DDR3-1333 (-CG)		Units	Note
		Min.	Max.	Min.	Max.		
VIH.CA(DC)	DC Input Logic High	Vref + 0.100	VDD	Vref + 0.100	VDD	V	1
VIL.CA(DC)	DC Input Logic Low	VSS	Vref - 0.100	VSS	Vref - 0.100	V	1
VIH.CA(AC)	AC Input Logic High	Vref + 0.175	Note 2	Vref + 0.175	Note 2	V	1, 2
VIL.CA(AC)	AC Input Logic Low	Note 2	Vref - 0.175	Note 2	Vref - 0.175	V	1, 2
VIH.CA(AC150)	AC Input Logic High	-	-	Vref + 0.15	Note 2	V	1, 2
VIL.CA(AC150)	AC Input Logic Low	-	-	Note 2	Vref - 0.15	V	1, 2
V _{RefCA(DC)}	Reference Voltage for ADD, CMD Inputs	0.49 x VDD	0.51 x VDD	0.49 x VDD	0.51 x VDD	V	3, 4

Note:

- For input only pins except $\overline{\text{RESET}}$. Vref = VrefCA(DC).
- See "Overshoot and Undershoot Specifications" in the device datasheet.
- The ac peak noise on VRef may not allow VRef to deviate from VRefDQ(DC) by more than +/-1% VDD (for reference: approx. +/- 15 mV).
- For reference: approx. VDD/2 +/- 15 mV.

Single-Ended AC and DC Input Levels for DQ and DM

Symbol	Parameter	DDR3-1066 (-BE)		DDR3-1333 (-CG)		Units	Note
		Min.	Max.	Min.	Max.		
VIH.DQ(DC)	DC Input Logic High	Vref + 0.100	VDD	Vref + 0.100	VDD	V	1
VIL.DQ(DC)	DC Input Logic Low	VSS	Vref - 0.100	VSS	Vref - 0.100	V	1
VIH.DQ(AC)	AC Input Logic High	Vref + 0.175	Note 2	Vref + 0.15	Note 2	V	1, 2, 5
VIL.DQ(AC)	AC Input Logic Low	Note 2	Vref - 0.175	Note 2	Vref - 0.15	V	1, 2, 5
V _{RefDQ(DC)}	Reference Voltage for DQ, DM Inputs	0.49 x VDD	0.51 x VDD	0.49 x VDD	0.51 x VDD	V	3, 4

Note:

- For input only pins except $\overline{\text{RESET}}$. Vref = VrefDQ(DC).
- See "Overshoot and Undershoot Specifications" in the device datasheet.
- The ac peak noise on VRef may not allow VRef to deviate from VRefDQ(DC) by more than +/-1% VDD (for reference: approx. +/- 15 mV).
- For reference: approx. VDD/2 +/- 15 mV.
- Single-ended swing requirement for DQS, DQS# is 350 mV (peak to peak). Differential swing requirement for DQS - DQS# is 700 mV (peak to peak).

NT2GC72B89B0NJ/NT2GC72B89B2NJ/NT2GC72C89B0NJ/NT2GC72C89B2NJ
 NT4GC72B4PB0NL/NT4GC72C4PB0NL/NT4GC72C4PB2NL/NT4GC72B8PB0NL/NT4GC72C8PB0NL/NT4GC72C8PB2NL
 NT8GC72B4NB1NJ/NT8GC72B4NB3NJ/NT8GC72C4NB1NJ/NT8GC72C4NB3NJ
 NT16TC72B4NB1NL/NT16TC72C4NB1NL/NT16TC72C4NB3NL



2GB: 256M x 72 / 4GB: 512M x 72 / 8GB: 1G x 72 / 16GB: 2G x 72
PC3-8500 / PC3-10600
Registered DDR3 SDRAM DIMM

Operating, Standby, and Refresh Currents

$T_{CASE} = 0\text{ }^{\circ}\text{C} \sim 85\text{ }^{\circ}\text{C}$; $V_{DDQ} = V_{DD} = 1.5V \pm 0.075V$ [2GB – 1 Rank, 256Mx8 DDR3 SDRAMs]

Symbol	Parameter/Condition	PC3-8500	PC3-10600	Unit
		(-BE)	(-CG)	
IDD0	Operating One Bank Active-Precharge Current	649	697	mA
IDD1	Operating One Bank Active-Read-Precharge Current	816	879	mA
IDD2P1	Precharge Power-Down Current Fast Exit	117	135	mA
IDD2Q	Precharge Quiet Standby Current	187	214	mA
IDD2N	Precharge Standby Current	205	238	mA
IDD3P	Active Power-Down Current	128	145	mA
IDD3N	Active Standby Current	265	265	mA
IDD4R	Operating Burst Read Current	1137	1370	mA
IDD4W	Operating Burst Write Current	1156	1378	mA
IDD5B	Burst Refresh Current	1723	1733	mA
IDD6	Self Refresh Current: Normal Temperature Range	94	94	mA
IDD7	Operating Bank Interleave Read Current	2914	3552	mA

$T_{CASE} = 0\text{ }^{\circ}\text{C} \sim 85\text{ }^{\circ}\text{C}$; $V_{DDQ} = V_{DD} = 1.35V -0.0675/+0.1V$ [2GB – 1 Rank, 256Mx8 DDR3 SDRAMs]

Symbol	Parameter/Condition	PC3-8500	PC3-10600	Unit
		(-BE)	(-CG)	
IDD0	Operating One Bank Active-Precharge Current	634	673	mA
IDD1	Operating One Bank Active-Read-Precharge Current	780	836	mA
IDD2P1	Precharge Power-Down Current Fast Exit	103	117	mA
IDD2Q	Precharge Quiet Standby Current	157	177	mA
IDD2N	Precharge Standby Current	172	193	mA
IDD3P	Active Power-Down Current	111	125	mA
IDD3N	Active Standby Current	228	228	mA
IDD4R	Operating Burst Read Current	1119	1346	mA
IDD4W	Operating Burst Write Current	1139	1356	mA
IDD5B	Burst Refresh Current	1663	1673	mA
IDD6	Self Refresh Current: Normal Temperature Range	74	74	mA
IDD7	Operating Bank Interleave Read Current	2822	3406	mA

NT2GC72B89B0NJ/NT2GC72B89B2NJ/NT2GC72C89B0NJ/NT2GC72C89B2NJ
 NT4GC72B4PB0NL/NT4GC72C4PB0NL/NT4GC72C4PB2NL/NT4GC72B8PB0NL/NT4GC72C8PB0NL/NT4GC72C8PB2NL
 NT8GC72B4NB1NJ/NT8GC72B4NB3NJ/NT8GC72C4NB1NJ/NT8GC72C4NB3NJ
 NT16TC72B4NB1NL/NT16TC72C4NB1NL/NT16TC72C4NB3NL



2GB: 256M x 72 / 4GB: 512M x 72 / 8GB: 1G x 72 / 16GB: 2G x 72
PC3-8500 / PC3-10600
Registered DDR3 SDRAM DIMM

T_{CASE} = 0 °C ~ 85 °C; V_{DDQ} = V_{DD} = 1.5V ± 0.075V [4GB – 2 Rank, 256Mx8 DDR3 SDRAMs]

Symbol	Parameter/Condition	PC3-8500	PC3-10600	Unit
		(-BE)	(-CG)	
IDD0	Operating One Bank Active-Precharge Current	915	962	mA
IDD1	Operating One Bank Active-Read-Precharge Current	1081	1144	mA
IDD2P1	Precharge Power-Down Current Fast Exit	235	269	mA
IDD2Q	Precharge Quiet Standby Current	375	428	mA
IDD2N	Precharge Standby Current	409	475	mA
IDD3P	Active Power-Down Current	256	290	mA
IDD3N	Active Standby Current	531	531	mA
IDD4R	Operating Burst Read Current	1402	1635	mA
IDD4W	Operating Burst Write Current	1422	1643	mA
IDD5B	Burst Refresh Current	1988	1998	mA
IDD6	Self Refresh Current: Normal Temperature Range	187	187	mA
IDD7	Operating Bank Interleave Read Current	3179	3817	mA

T_{CASE} = 0 °C ~ 85 °C; V_{DDQ} = V_{DD} = 1.35V -0.0675/+0.1V [4GB – 2 Rank, 256Mx8 DDR3 SDRAMs]

Symbol	Parameter/Condition	PC3-8500	PC3-10600	Unit
		(-BE)	(-CG)	
IDD0	Operating One Bank Active-Precharge Current	863	902	mA
IDD1	Operating One Bank Active-Read-Precharge Current	1010	1064	mA
IDD2P1	Precharge Power-Down Current Fast Exit	206	235	mA
IDD2Q	Precharge Quiet Standby Current	314	354	mA
IDD2N	Precharge Standby Current	343	385	mA
IDD3P	Active Power-Down Current	222	251	mA
IDD3N	Active Standby Current	457	457	mA
IDD4R	Operating Burst Read Current	1348	1575	mA
IDD4W	Operating Burst Write Current	1368	1585	mA
IDD5B	Burst Refresh Current	1893	1901	mA
IDD6	Self Refresh Current: Normal Temperature Range	148	148	mA
IDD7	Operating Bank Interleave Read Current	3051	3634	mA

NT2GC72B89B0NJ/NT2GC72B89B2NJ/NT2GC72C89B0NJ/NT2GC72C89B2NJ
 NT4GC72B4PB0NL/NT4GC72C4PB0NL/NT4GC72C4PB2NL/NT4GC72B8PB0NL/NT4GC72C8PB0NL/NT4GC72C8PB2NL
 NT8GC72B4NB1NJ/NT8GC72B4NB3NJ/NT8GC72C4NB1NJ/NT8GC72C4NB3NJ
 NT16TC72B4NB1NL/NT16TC72C4NB1NL/NT16TC72C4NB3NL



2GB: 256M x 72 / 4GB: 512M x 72 / 8GB: 1G x 72 / 16GB: 2G x 72
PC3-8500 / PC3-10600
Registered DDR3 SDRAM DIMM

T_{CASE} = 0 °C ~ 85 °C; V_{DDQ} = V_{DD} = 1.5V ± 0.075V [4GB – 1 Rank, 512Mx4 DDR3 SDRAMs]

Symbol	Parameter/Condition	PC3-8500	PC3-10600	Unit
		(-BE)	(-CG)	
IDD0	Operating One Bank Active-Precharge Current	1307	1402	mA
IDD1	Operating One Bank Active-Read-Precharge Current	1624	1734	mA
IDD2P1	Precharge Power-Down Current Fast Exit	285	325	mA
IDD2Q	Precharge Quiet Standby Current	428	483	mA
IDD2N	Precharge Standby Current	467	523	mA
IDD3P	Active Power-Down Current	317	356	mA
IDD3N	Active Standby Current	491	554	mA
IDD4R	Operating Burst Read Current	2202	2645	mA
IDD4W	Operating Burst Write Current	2154	2574	mA
IDD5B	Burst Refresh Current	3366	3445	mA
IDD6	Self Refresh Current: Normal Temperature Range	135	135	mA
IDD7	Operating Bank Interleave Read Current	5655	6930	mA

T_{CASE} = 0 °C ~ 85 °C; V_{DDQ} = V_{DD} = 1.35V -0.0675/+0.1V [4GB – 1 Rank, 512Mx4 DDR3 SDRAMs]

Symbol	Parameter/Condition	PC3-8500	PC3-10600	Unit
		(-BE)	(-CG)	
IDD0	Operating One Bank Active-Precharge Current	1283	1378	mA
IDD1	Operating One Bank Active-Read-Precharge Current	1600	1711	mA
IDD2P1	Precharge Power-Down Current Fast Exit	285	317	mA
IDD2Q	Precharge Quiet Standby Current	420	475	mA
IDD2N	Precharge Standby Current	459	515	mA
IDD3P	Active Power-Down Current	309	348	mA
IDD3N	Active Standby Current	483	546	mA
IDD4R	Operating Burst Read Current	2075	2487	mA
IDD4W	Operating Burst Write Current	2123	2534	mA
IDD5B	Burst Refresh Current	3263	3334	mA
IDD6	Self Refresh Current: Normal Temperature Range	135	135	mA
IDD7	Operating Bank Interleave Read Current	5536	6780	mA

NT2GC72B89B0NJ/NT2GC72B89B2NJ/NT2GC72C89B0NJ/NT2GC72C89B2NJ
 NT4GC72B4PB0NL/NT4GC72C4PB0NL/NT4GC72C4PB2NL/NT4GC72B8PB0NL/NT4GC72C8PB0NL/NT4GC72C8PB2NL
 NT8GC72B4NB1NJ/NT8GC72B4NB3NJ/NT8GC72C4NB1NJ/NT8GC72C4NB3NJ
 NT16TC72B4NB1NL/NT16TC72C4NB1NL/NT16TC72C4NB3NL



2GB: 256M x 72 / 4GB: 512M x 72 / 8GB: 1G x 72 / 16GB: 2G x 72
PC3-8500 / PC3-10600
Registered DDR3 SDRAM DIMM

T_{CASE} = 0 °C ~ 85 °C; V_{DDQ} = V_{DD} = 1.5V ± 0.075V [8GB – 2 Rank, 512Mx4 DDR3 SDRAMs]

Symbol	Parameter/Condition	PC3-8500	PC3-10600	Unit
		(-BE)	(-CG)	
IDD0	Operating One Bank Active-Precharge Current	1798	1956	mA
IDD1	Operating One Bank Active-Read-Precharge Current	2115	2289	mA
IDD2P1	Precharge Power-Down Current Fast Exit	570	649	mA
IDD2Q	Precharge Quiet Standby Current	855	966	mA
IDD2N	Precharge Standby Current	935	1045	mA
IDD3P	Active Power-Down Current	634	713	mA
IDD3N	Active Standby Current	982	1109	mA
IDD4R	Operating Burst Read Current	2693	3200	mA
IDD4W	Operating Burst Write Current	2645	3128	mA
IDD5B	Burst Refresh Current	3857	4000	mA
IDD6	Self Refresh Current: Normal Temperature Range	269	269	mA
IDD7	Operating Bank Interleave Read Current	6146	7484	mA

T_{CASE} = 0 °C ~ 85 °C; V_{DDQ} = V_{DD} = 1.35V -0.0675/+0.1V [8GB – 2 Rank, 512Mx4 DDR3 SDRAMs]

Symbol	Parameter/Condition	PC3-8500	PC3-10600	Unit
		(-BE)	(-CG)	
IDD0	Operating One Bank Active-Precharge Current	1766	1925	mA
IDD1	Operating One Bank Active-Read-Precharge Current	2083	2257	mA
IDD2P1	Precharge Power-Down Current Fast Exit	570	634	mA
IDD2Q	Precharge Quiet Standby Current	840	950	mA
IDD2N	Precharge Standby Current	919	1030	mA
IDD3P	Active Power-Down Current	618	697	mA
IDD3N	Active Standby Current	966	1093	mA
IDD4R	Operating Burst Read Current	2558	3033	mA
IDD4W	Operating Burst Write Current	2606	3081	mA
IDD5B	Burst Refresh Current	3746	3881	mA
IDD6	Self Refresh Current: Normal Temperature Range	269	269	mA
IDD7	Operating Bank Interleave Read Current	6019	7326	mA

NT2GC72B89B0NJ/NT2GC72B89B2NJ/NT2GC72C89B0NJ/NT2GC72C89B2NJ
 NT4GC72B4PB0NL/NT4GC72C4PB0NL/NT4GC72C4PB2NL/NT4GC72B8PB0NL/NT4GC72C8PB0NL/NT4GC72C8PB2NL
 NT8GC72B4NB1NJ/NT8GC72B4NB3NJ/NT8GC72C4NB1NJ/NT8GC72C4NB3NJ
 NT16TC72B4NB1NL/NT16TC72C4NB1NL/NT16TC72C4NB3NL



2GB: 256M x 72 / 4GB: 512M x 72 / 8GB: 1G x 72 / 16GB: 2G x 72
PC3-8500 / PC3-10600
Registered DDR3 SDRAM DIMM

T_{CASE} = 0 °C ~ 85 °C; V_{DDQ} = V_{DD} = 1.5V ± 0.075V [16GB – 4 Rank, 1024Mx4 DDR3 SDRAMs]

Symbol	Parameter/Condition	PC3-8500	PC3-10600	Unit
		(-BE)	(-CG)	
IDD0	Operating One Bank Active-Precharge Current	2780	3065	mA
IDD1	Operating One Bank Active-Read-Precharge Current	3097	3398	mA
IDD2P1	Precharge Power-Down Current Fast Exit	1140	1299	mA
IDD2Q	Precharge Quiet Standby Current	1711	1932	mA
IDD2N	Precharge Standby Current	1869	2091	mA
IDD3P	Active Power-Down Current	1267	1426	mA
IDD3N	Active Standby Current	1964	2218	mA
IDD4R	Operating Burst Read Current	3675	4308	mA
IDD4W	Operating Burst Write Current	3627	4237	mA
IDD5B	Burst Refresh Current	4839	5108	mA
IDD6	Self Refresh Current: Normal Temperature Range	539	539	mA
IDD7	Operating Bank Interleave Read Current	7128	8593	mA

T_{CASE} = 0 °C ~ 85 °C; V_{DDQ} = V_{DD} = 1.35V -0.0675/+0.1V [16GB – 4 Rank, 1024Mx4 DDR3 SDRAMs]

Symbol	Parameter/Condition	PC3-8500	PC3-10600	Unit
		(-BE)	(-CG)	
IDD0	Operating One Bank Active-Precharge Current	2732	3018	mA
IDD1	Operating One Bank Active-Read-Precharge Current	3049	3350	mA
IDD2P1	Precharge Power-Down Current Fast Exit	1140	1267	mA
IDD2Q	Precharge Quiet Standby Current	1679	1901	mA
IDD2N	Precharge Standby Current	1837	2059	mA
IDD3P	Active Power-Down Current	1236	1394	mA
IDD3N	Active Standby Current	1932	2186	mA
IDD4R	Operating Burst Read Current	3524	4126	mA
IDD4W	Operating Burst Write Current	3572	4174	mA
IDD5B	Burst Refresh Current	4712	4974	mA
IDD6	Self Refresh Current: Normal Temperature Range	539	539	mA
IDD7	Operating Bank Interleave Read Current	6985	8419	mA



2GB: 256M x 72 / 4GB: 512M x 72 / 8GB: 1G x 72 / 16GB: 2G x 72
PC3-8500 / PC3-10600
Registered DDR3 SDRAM DIMM

Standard Speed Bins

DDR3-1066MHz

Speed Bin		DDR3-1066		Unit	
CL-nRCD-nRP		7-7-7 (-BE)			
Parameter	Symbol	Min	Max		
Internal read command to first data	tAA	13.125	20.000	ns	
ACT to internal read or write delay time	tRCD	13.125	-	ns	
PRE command period	tRP	13.125	-	ns	
ACT to ACT or REF command period	tRC	50.625	-	ns	
ACT to PRE command period	tRAS	37.500	9*tREFI	ns	
CL=5	CWL=5	tCK(AVG)	3.000	3.300	ns
	CWL=6	tCK(AVG)	Reserved		ns
CL=6	CWL=5	tCK(AVG)	2.500	3.300	ns
	CWL=6	tCK(AVG)	Reserved		ns
CL=7	CWL=5	tCK(AVG)	Reserved		ns
	CWL=6	tCK(AVG)	1.875	<2.5	ns
CL=8	CWL=5	tCK(AVG)	Reserved		ns
	CWL=6	tCK(AVG)	1.875	<2.5	ns
Supported CL Settings		6,7,8		nCK	
Supported CWL Settings		5,6		nCK	

DDR3-1333MHz

Speed Bin		DDR3-1333		Unit	
CL-nRCD-nRP		9-9-9 (-CG)			
Parameter	Symbol	Min	Max		
Internal read command to first data	tAA	13.125 (13.125) ^{5,11}	20.000	ns	
ACT to internal read or write delay time	tRCD	13.125 (13.125) ^{5,11}	-	ns	
PRE command period	tRP	13.125 (13.125) ^{5,11}	-	ns	
ACT to ACT or REF command period	tRC	49.125 (49.125) ^{5,11}	-	ns	
ACT to PRE command period	tRAS	36.000	9*tREFI	ns	
CL=5	CWL=5	tCK(AVG)	Reserved	Reserved	ns
	CWL=6	tCK(AVG)	Reserved	Reserved	ns
	CWL=7	tCK(AVG)	Reserved	Reserved	ns
CL=6	CWL=5	tCK(AVG)	2.500	3.300	ns
	CWL=6	tCK(AVG)	Reserved	Reserved	ns
	CWL=7	tCK(AVG)	Reserved	Reserved	ns
CL=7	CWL=5	tCK(AVG)	Reserved	Reserved	ns
	CWL=6	tCK(AVG)	1.875*	<2.5*	ns
	CWL=7	tCK(AVG)	Reserved	Reserved	ns
CL=8	CWL=5	tCK(AVG)	Reserved	Reserved	ns
	CWL=6	tCK(AVG)	1.875	<2.5	ns
	CWL=7	tCK(AVG)	Reserved	Reserved	ns
CL=9	CWL=5	tCK(AVG)	Reserved	Reserved	ns
	CWL=6	tCK(AVG)	Reserved	Reserved	ns
	CWL=7	tCK(AVG)	1.500	<1.875	ns
CL=10	CWL=5	tCK(AVG)	Reserved	Reserved	ns
	CWL=6	tCK(AVG)	Reserved	Reserved	ns
	CWL=7	tCK(AVG)	1.500*	<1.875*	ns
Supported CL Settings		6,7,8,9		nCK	
Supported CWL Settings		5,6,7		nCK	



2GB: 256M x 72 / 4GB: 512M x 72 / 8GB: 1G x 72 / 16GB: 2G x 72
PC3-8500 / PC3-10600
Registered DDR3 SDRAM DIMM

AC Timing Specifications for DDR3 SDRAM Devices Used on Module (1066MHz)

Parameter	Symbol	DDR3-1066		Units	Notes
		Min.	Max.		
Clock Timing					
Minimum Clock Cycle Time (DLL off mode)	tCK (DLL_OFF)	8	-	ns	
Average Clock Period	tCK(avg)	Refer to *Standard Speed Bins		ps	
Average high pulse width	tCH(avg)	0.47	0.53	tCK(avg)	
Average low pulse width	tCL(avg)	0.47	0.53	tCK(avg)	
Absolute Clock Period	tCK(abs)	Min.: tCK(avg)min + tJIT(per)min Max.: tCK(avg)max + tJIT(per)max		ps	
Absolute clock HIGH pulse width	tCH(abs)	0.43	-	tCK(avg)	
Absolute clock LOW pulse width	tCL(abs)	0.43	-	tCK(avg)	
Clock Period Jitter	JIT(per)	-90	90	ps	
Clock Period Jitter during DLL locking period	JIT(per, lck)	-80	80	ps	
Cycle to Cycle Period Jitter	tJIT(cc)	180	180	ps	
Cycle to Cycle Period Jitter during DLL locking period	JIT(cc, lck)	160	160	ps	
Duty Cycle Jitter	tJIT(duty)	-	-	ps	
Cumulative error across 2 cycles	tERR(2per)	-132	132	ps	
Cumulative error across 3 cycles	tERR(3per)	-157	157	ps	
Cumulative error across 4 cycles	tERR(4per)	-175	175	ps	
Cumulative error across 5 cycles	tERR(5per)	-188	188	ps	
Cumulative error across 6 cycles	tERR(6per)	-200	200	ps	
Cumulative error across 7 cycles	tERR(7per)	-209	209	ps	
Cumulative error across 8 cycles	tERR(8per)	-217	217	ps	
Cumulative error across 9 cycles	tERR(9per)	-224	224	ps	
Cumulative error across 10 cycles	tERR(10per)	-231	231	ps	
Cumulative error across 11 cycles	tERR(11per)	-237	237	ps	
Cumulative error across 12 cycles	tERR(12per)	-242	242	ps	
Cumulative error across n = 13, 14 . . . 49, 50 cycles	tERR(nper)	tERR(nper)min = (1 + 0.68ln(n)) * tJIT(per)min tERR(nper)max = (1 + 0.68ln(n)) * tJIT(per)max		ps	
Data Timing					
DQS, DQS# to DQ skew, per group, per access	tDQSQ	-	150	ps	
DQ output hold time from DQS, DQS#	tQH	0.38	-	tCK(avg)	
DQ low-impedance time from CK, CK#	tLZ(DQ)	-600	300	ps	
DQ high impedance time from CK, CK#	tHZ(DQ)	-	300	ps	
Data setup time to DQS, DQS# referenced to Vih(ac) / Vil(ac) levels	tDS(base) AC175	25		ps	
Data setup time to DQS, DQS# referenced to Vih(ac) / Vil(ac) levels	tDS(base) AC150	75		ps	
Data hold time from DQS, DQS# referenced to Vih(dc) / Vil(dc) levels	tDH(base) DC100	100		ps	
DQ and DM Input pulse width for each input	tDIPW	490		ps	
Data Strobe Timing					
DQS, DQS# differential READ Preamble	tRPRE	0.9	Note 19	tCK(avg)	
DQS, DQS# differential READ Postamble	tRPST	0.3	Note 11	tCK(avg)	
DQS, DQS# differential output high time	tQSH	0.38	-	tCK(avg)	
DQS, DQS# differential output low time	tQSL	0.38	-	tCK(avg)	
DQS, DQS# differential WRITE Preamble	tWPRE	0.9	-	tCK(avg)	
DQS, DQS# differential WRITE Postamble	tWPST	0.3	-	tCK(avg)	
DQS, DQS# rising edge output access time from rising CK, CK#	tDQSCK	-300	300	tCK(avg)	
DQS and DQS# low-impedance time (Referenced from RL - 1)	tLZ(DQS)	-600	300	tCK(avg)	
DQS and DQS# high-impedance time (Referenced from RL + BL/2)	tHZ(DQS)	-	300	tCK(avg)	
DQS, DQS# differential input low pulse width	tDQSL	0.45	0.55	tCK(avg)	
DQS, DQS# differential input high pulse width	tDQSH	0.45	0.55	tCK(avg)	
DQS, DQS# rising edge to CK, CK# rising edge	tDQSS	-0.25	0.25	tCK(avg)	
DQS, DQS# falling edge setup time to CK, CK# rising edge	tDSS	0.2	-	tCK(avg)	
DQS, DQS# falling edge hold time from CK, CK# rising edge	tDSH	0.2	-	tCK(avg)	
Command and Address Timing					



2GB: 256M x 72 / 4GB: 512M x 72 / 8GB: 1G x 72 / 16GB: 2G x 72
PC3-8500 / PC3-10600
Registered DDR3 SDRAM DIMM

DLL locking time	tDLLK	512	-	nCK	
Internal READ Command to PRECHARGE Command delay	tRTP		tRTPmin.: max(4nCK, 7.5ns) tRTPmax.: -		
Delay from start of internal write transaction to internal read command	tWTR		tWTRmin.: max(4nCK, 7.5ns) tWTRmax.:		
WRITE recovery time	tWR	15	-	ns	
Mode Register Set command cycle time	tMRD	4	-	nCK	
Mode Register Set command update delay	tMOD		tMODmin.: max(12nCK, 15ns) tMODmax.:		
ACT to internal read or write delay time	tRCD				
PRE command period	tRP				
ACT to ACT or REF command period	tRC				
CAS# to CAS# command delay	tCCD	4	-	nCK	
Auto precharge write recovery + precharge time	tDAL(min)		WR + roundup(tRP / tCK(avg))	nCK	
Multi-Purpose Register Recovery Time	tMPRR	1	-	nCK	
ACTIVE to PRECHARGE command period	tRAS		Standard Speed Bins		
ACTIVE to ACTIVE command period for 1KB page size	tRRD		max(4nCK, 7.5ns)	-	
ACTIVE to ACTIVE command period for 2KB page size	tRRD		tRRDmin.: max(4nCK, 10ns) tRRDmax.:		
Four activate window for 1KB page size	tFAW	37.5	-	ns	
Four activate window for 2KB page size	tFAW	50	-	ns	
Command and Address setup time to CK, CK# referenced to Vih(ac) / Vil(ac) levels	tIS(base)	125	-	ps	
Command and Address hold time from CK, CK# referenced to Vih(dc) / Vil(dc) levels	tIH(base)	200	-	ps	
Command and Address setup time to CK, CK# referenced to Vih(ac) / Vil(ac) levels	tIS(base) AC150	125+150	-	ps	
Control and Address Input pulse width for each input	tIPW	780	-	ps	
Calibration Timing					
Power-up and RESET calibration time	tZQinit	512	-	nCK	
Normal operation Full calibration time	tZQoper	256	-	nCK	
Normal operation Short calibration time	tZQCS	64	-	nCK	
Reset Timing					
Exit Reset from CKE HIGH to a valid command	tXPR		tXPRmin.: max(5nCK, tRFC(min) + 10ns) tXPRmax.: -		
Self Refresh Timings					
Exit Self Refresh to commands not requiring a locked DLL	tXS		tXSmin.: max(5nCK, tRFC(min) + 10ns) tXSmax.: -		
Exit Self Refresh to commands requiring a locked DLL	tXSDLL		tXSDLLmin.: tDLLK(min) tXSDLLmax.: -	nCK	
Minimum CKE low width for Self Refresh entry to exit timing	tCKESR		tCKESRmin.: tCKE(min) + 1 nCK tCKESRmax.: -		
Valid Clock Requirement after Self Refresh Entry (SRE) or Power-Down Entry (PDE)	tCKSRE		tCKSREmin.: max(5 nCK, 10 ns) tCKSREmax.: -		
Valid Clock Requirement before Self Refresh Exit (SRX) or Power-Down Exit (PDX) or Reset Exit	tCKSRX		tCKSRXmin.: max(5 nCK, 10 ns) tCKSRXmax.: -		
Power Down Timings					
Exit Power Down with DLL on to any valid command; Exit Precharge Power Down with DLL frozen to commands not requiring a locked DLL	tXP		tXPmin.: max(3nCK, 7.5ns) tXPmax.: -		
Exit Precharge Power Down with DLL frozen to commands requiring a locked DLL	tXPDLL		tXPDLLmin.: max(10nCK, 24ns) tXPDLLmax.: -		
CKE minimum pulse width	tCKE		tCKEmin.: max(3nCK 5.625ns) tCKEmax.: -		
Command pass disable delay	tCPDED		tCPDEDmin.: 1 tCPDEDmin.: -	nCK	
Power Down Entry to Exit Timing	tPD		tPDmin.: tCKE(min) tPDmax.: 9*tREFI		
Timing of ACT command to Power Down entry	tACTPDEN		tACTPDENmin.: 1 tACTPDENmax.: -	nCK	
Timing of PRE or PREA command to Power Down entry	tPRPDEN		tPRPDENmin.: 1	nCK	

NT2GC72B89B0NJ/NT2GC72B89B2NJ/NT2GC72C89B0NJ/NT2GC72C89B2NJ
 NT4GC72B4PB0NL/NT4GC72C4PB0NL/NT4GC72C4PB2NL/NT4GC72B8PB0NL/NT4GC72C8PB0NL/NT4GC72C8PB2NL
 NT8GC72B4NB1NJ/NT8GC72B4NB3NJ/NT8GC72C4NB1NJ/NT8GC72C4NB3NJ
 NT16TC72B4NB1NL/NT16TC72C4NB1NL/NT16TC72C4NB3NL



2GB: 256M x 72 / 4GB: 512M x 72 / 8GB: 1G x 72 / 16GB: 2G x 72
PC3-8500 / PC3-10600
Registered DDR3 SDRAM DIMM

		tPRPDENmax.: -			
Timing of RD/RDA command to Power Down entry	tRDPDEN	tRDPDENmin.: RL+4+1 tRDPDENmax.: -		nCK	
Timing of WR command to Power Down entry (BL8OTF, BL8MRS, BC4OTF)	tWRPDEN	tWRPDENmin.: WL + 4 + (tWR / tCK(avg)) tWRPDENmax.: -		nCK	
Timing of WRA command to Power Down entry (BL8OTF, BL8MRS, BC4OTF)	tWRAPDEN	tWRAPDENmin.: WL+4+WR+1 tWRAPDENmax.: -		nCK	
Timing of WR command to Power Down entry (BC4MRS)	tWRPDEN	tWRPDENmin.: WL + 2 + (tWR / tCK(avg)) tWRPDENmax.: -		nCK	
Timing of WRA command to Power Down entry (BC4MRS)	tWRAPDEN	tWRAPDENmin.: WL + 2 +WR + 1 tWRAPDENmax.: -		nCK	
Timing of REF command to Power Down entry	tREFPDEN	tREFPDENmin.: 1 tREFPDENmax.: -		nCK	
Timing of MRS command to Power Down entry	tMRSPDEN	tMRSPDENmin.: tMOD(min) tMRSPDENmax.: -			
ODT Timings					
ODT high time without write command or with write command and BC4	ODTH4	ODTH4min.: 4 ODTH4max.: -		nCK	
ODT high time with Write command and BL8	ODTH8	ODTH8min.: 6 ODTH8max.: -		nCK	
Asynchronous RTT turn-on delay (Power-Down with DLL frozen)	tAONPD	2	8.5	ns	
Asynchronous RTT turn-off delay (Power-Down with DLL frozen)	tAOFPD	2	8.5	ns	
RTT turn-on	tAON	-300	300	ps	
RTT_Nom and RTT_WR turn-off time from ODTLoff reference	tAOF	0.3	0.7	tCK(avg)	
RTT dynamic change skew	tADC	0.3	0.7	tCK(avg)	
Write Leveling Timings					
First DQS/DQS# rising edge after write leveling mode is programmed	tWLMRD	40	-	nCK	
DQS/DQS# delay after write leveling mode is programmed	tWLDQSEN	25	-	nCK	
Write leveling setup time from rising CK, CK# crossing to rising DQS, DQS# crossing	tWLS	245	-	ps	
Write leveling hold time from rising DQS, DQS# crossing to rising CK, CK# crossing	tWLH	245	-	ps	
Write leveling output delay	tWLO	0	9	ns	
Write leveling output error	tWLOE	0	2	ns	



2GB: 256M x 72 / 4GB: 512M x 72 / 8GB: 1G x 72 / 16GB: 2G x 72
PC3-8500 / PC3-10600
Registered DDR3 SDRAM DIMM

AC Timing Specifications for DDR3 SDRAM Devices Used on Module (1333MHz)

Parameter	Symbol	DDR3-1333		Units	Notes
		Min.	Max.		
Clock Timing					
Minimum Clock Cycle Time (DLL off mode)	tCK (DLL_OFF)	8	-	ns	
Average Clock Period	tCK(avg)	Refer to *Standard Speed Bins		ps	
Average high pulse width	tCH(avg)	0.47	0.53	tCK(avg)	
Average low pulse width	tCL(avg)	0.47	0.53	tCK(avg)	
Absolute Clock Period	tCK(abs)	Min.: tCK(avg)min + tJIT(per)min Max.: tCK(avg)max + tJIT(per)max		ps	
Absolute clock HIGH pulse width	tCH(abs)	0.43	-	tCK(avg)	
Absolute clock LOW pulse width	tCL(abs)	0.43	-	tCK(avg)	
Clock Period Jitter	JIT(per)	-80	80	ps	
Clock Period Jitter during DLL locking period	JIT(per, lck)	-70	70	ps	
Cycle to Cycle Period Jitter	tJIT(cc)	160	160	ps	
Cycle to Cycle Period Jitter during DLL locking period	JIT(cc, lck)	140	140	ps	
Duty Cycle Jitter	tJIT(duty)	-	-	ps	
Cumulative error across 2 cycles	tERR(2per)	-118	118	ps	
Cumulative error across 3 cycles	tERR(3per)	-140	140	ps	
Cumulative error across 4 cycles	tERR(4per)	-155	155	ps	
Cumulative error across 5 cycles	tERR(5per)	-168	168	ps	
Cumulative error across 6 cycles	tERR(6per)	-177	177	ps	
Cumulative error across 7 cycles	tERR(7per)	-186	186	ps	
Cumulative error across 8 cycles	tERR(8per)	-193	193	ps	
Cumulative error across 9 cycles	tERR(9per)	-200	200	ps	
Cumulative error across 10 cycles	tERR(10per)	-205	205	ps	
Cumulative error across 11 cycles	tERR(11per)	-210	210	ps	
Cumulative error across 12 cycles	tERR(12per)	-215	215	ps	
Cumulative error across n = 13, 14 . . . 49, 50 cycles	tERR(nper)	tERR(nper)min = (1 + 0.68ln(n)) * tJIT(per)min tERR(nper)max = (1 + 0.68ln(n)) * tJIT(per)max		ps	
Data Timing					
DQS, DQS# to DQ skew, per group, per access	tDQSQ	-	125	ps	
DQ output hold time from DQS, DQS#	tQH	0.38	-	tCK(avg)	
DQ low-impedance time from CK, CK#	tLZ(DQ)	-500	250	ps	
DQ high impedance time from CK, CK#	tHZ(DQ)	-	250	ps	
Data setup time to DQS, DQS# referenced to Vih(ac) / Vil(ac) levels	tDS(base) AC175	-	-	ps	
Data setup time to DQS, DQS# referenced to Vih(ac) / Vil(ac) levels	tDS(base) AC150	30	-	ps	
Data hold time from DQS, DQS# referenced to Vih(dc) / Vil(dc) levels	tDH(base) DC100	65	-	ps	
DQ and DM Input pulse width for each input	tDIPW	400	-	ps	
Data Strobe Timing					
DQS, DQS# differential READ Preamble	tRPRE	0.9	Note 19	tCK(avg)	
DQS, DQS# differential READ Postamble	tRPST	0.3	Note 11	tCK(avg)	
DQS, DQS# differential output high time	tQSH	0.4	-	tCK(avg)	
DQS, DQS# differential output low time	tQSL	0.4	-	tCK(avg)	
DQS, DQS# differential WRITE Preamble	tWPRE	0.9	-	tCK(avg)	
DQS, DQS# differential WRITE Postamble	tWPST	0.3	-	tCK(avg)	
DQS, DQS# rising edge output access time from rising CK, CK#	tDQSCK	-255	255	tCK(avg)	
DQS and DQS# low-impedance time (Referenced from RL - 1)	tLZ(DQS)	-500	250	tCK(avg)	
DQS and DQS# high-impedance time (Referenced from RL + BL/2)	tHZ(DQS)	-	250	tCK(avg)	
DQS, DQS# differential input low pulse width	tDQSL	0.45	0.55	tCK(avg)	
DQS, DQS# differential input high pulse width	tDQSH	0.45	0.55	tCK(avg)	
DQS, DQS# rising edge to CK, CK# rising edge	tDQSS	-0.25	0.25	tCK(avg)	
DQS, DQS# falling edge setup time to CK, CK# rising edge	tDSS	0.2	-	tCK(avg)	
DQS, DQS# falling edge hold time from CK, CK# rising edge	tDSH	0.2	-	tCK(avg)	
Command and Address Timing					



2GB: 256M x 72 / 4GB: 512M x 72 / 8GB: 1G x 72 / 16GB: 2G x 72
PC3-8500 / PC3-10600
Registered DDR3 SDRAM DIMM

DLL locking time	tDLLK	512	-	nCK	
Internal READ Command to PRECHARGE Command delay	tRTP	tRTPmin.: max(4nCK, 7.5ns) tRTPmax.: -			
Delay from start of internal write transaction to internal read command	tWTR	tWTRmin.: max(4nCK, 7.5ns) tWTRmax.:			
WRITE recovery time	tWR	15	-	ns	
Mode Register Set command cycle time	tMRD	4	-	nCK	
Mode Register Set command update delay	tMOD	tMODmin.: max(12nCK, 15ns) tMODmax.:			
ACT to internal read or write delay time	tRCD				
PRE command period	tRP				
ACT to ACT or REF command period	tRC				
CAS# to CAS# command delay	tCCD	4		nCK	
Auto precharge write recovery + precharge time	tDAL(min)	WR + roundup(tRP / tCK(avg))		nCK	
Multi-Purpose Register Recovery Time	tMPRR	1	-	nCK	
ACTIVE to PRECHARGE command period	tRAS	Standard Speed Bins			
ACTIVE to ACTIVE command period for 1KB page size	tRRD	tRRDmin.: max(4nCK, 6ns) tRRDmax.:			
ACTIVE to ACTIVE command period for 2KB page size	tRRD	tRRDmin.: max(4nCK, 7.5ns) tRRDmax.:			
Four activate window for 1KB page size	tFAW	30	0	ns	
Four activate window for 2KB page size	tFAW	45	0	ns	
Command and Address setup time to CK, CK# referenced to Vih(ac) / Vil(ac) levels	tIS(base)	65	-	ps	
Command and Address hold time from CK, CK# referenced to Vih(dc) / Vil(dc) levels	tIH(base)	140	-	ps	
Command and Address setup time to CK, CK# referenced to Vih(ac) / Vil(ac) levels	tIS(base) AC150	65+125	-	ps	
Control and Address Input pulse width for each input	tIPW	620	-	ps	
Calibration Timing					
Power-up and RESET calibration time	tZQinit	512	-	nCK	
Normal operation Full calibration time	tZQoper	256	-	nCK	
Normal operation Short calibration time	tZQCS	64	-	nCK	
Reset Timing					
Exit Reset from CKE HIGH to a valid command	tXPR	tXPRmin.: max(5nCK, tRFC(min) + 10ns) tXPRmax.: -			
Self Refresh Timings					
Exit Self Refresh to commands not requiring a locked DLL	tXS	tXSmin.: max(5nCK, tRFC(min) + 10ns) tXSmax.: -			
Exit Self Refresh to commands requiring a locked DLL	tXSDLL	tXSDLLmin.: tDLLK(min) tXSDLLmax.: -		nCK	
Minimum CKE low width for Self Refresh entry to exit timing	tCKESR	tCKESRmin.: tCKE(min) + 1 nCK tCKESRmax.: -			
Valid Clock Requirement after Self Refresh Entry (SRE) or Power-Down Entry (PDE)	tCKSRE	tCKSREmin.: max(5 nCK, 10 ns) tCKSREmax.: -			
Valid Clock Requirement before Self Refresh Exit (SRX) or Power-Down Exit (PDX) or Reset Exit	tCKSRX	tCKSRXmin.: max(5 nCK, 10 ns) tCKSRXmax.: -			
Power Down Timings					
Exit Power Down with DLL on to any valid command; Exit Precharge Power Down with DLL frozen to commands not requiring a locked DLL	tXP	tXPmin.: max(3nCK, 6ns) tXPmax.: -			
Exit Precharge Power Down with DLL frozen to commands requiring a locked DLL	tXPDLL	tXPDLLmin.: max(10nCK, 24ns) tXPDLLmax.: -			
CKE minimum pulse width	tCKE	tCKEmin.: max(3nCK, 5.625ns) tCKEmax.: -			
Command pass disable delay	tCPDED	tCPDEDmin.: 1 tCPDEDmin.: -		nCK	
Power Down Entry to Exit Timing	tPD	tPDmin.: tCKE(min) tPDmax.: 9*tREFI			
Timing of ACT command to Power Down entry	tACTPDEN	tACTPDENmin.: 1 tACTPDENmax.: -		nCK	



2GB: 256M x 72 / 4GB: 512M x 72 / 8GB: 1G x 72 / 16GB: 2G x 72
PC3-8500 / PC3-10600
Registered DDR3 SDRAM DIMM

Timing of PRE or PREA command to Power Down entry	tPRPDEN	tPRPDENmin.: 1 tPRPDENmax.: -		nCK	
Timing of RD/RDA command to Power Down entry	tRDPDEN	tRDPDENmin.: RL+4+1 tRDPDENmax.: -		nCK	
Timing of WR command to Power Down entry (BL8OTF, BL8MRS, BC4OTF)	tWRPDEN	tWRPDENmin.: WL + 4 + (tWR / tCK(avg)) tWRPDENmax.: -		nCK	
Timing of WRA command to Power Down entry (BL8OTF, BL8MRS, BC4OTF)	tWRAPDEN	tWRAPDENmin.: WL+4+WR+1 tWRAPDENmax.: -		nCK	
Timing of WR command to Power Down entry (BC4MRS)	tWRPDEN	tWRPDENmin.: WL + 2 + (tWR / tCK(avg)) tWRPDENmax.: -		nCK	
Timing of WRA command to Power Down entry (BC4MRS)	tWRAPDEN	tWRAPDENmin.: WL + 2 +WR + 1 tWRAPDENmax.: -		nCK	
Timing of REF command to Power Down entry	tREFPDEN	tREFPDENmin.: 1 tREFPDENmax.: -		nCK	
Timing of MRS command to Power Down entry	tMRSPDEN	tMRSPDENmin.: tMOD(min) tMRSPDENmax.: -			
ODT Timings					
ODT high time without write command or with write command and BC4	ODTH4	ODTH4min.: 4 ODTH4max.: -		nCK	
ODT high time with Write command and BL8	ODTH8	ODTH8min.: 6 ODTH8max.: -		nCK	
Asynchronous RTT turn-on delay (Power-Down with DLL frozen)	tAONPD	2	8.5	ns	
Asynchronous RTT turn-off delay (Power-Down with DLL frozen)	tAOFDP	2	8.5	ns	
RTT turn-on	tAON	-250	250	ps	
RTT_Nom and RTT_WR turn-off time from ODTLoff reference	tAOF	0.3	0.7	tCK(avg)	
RTT dynamic change skew	tADC	0.3	0.7	tCK(avg)	
Write Leveling Timings					
First DQS/DQS# rising edge after write leveling mode is programmed	tWLMRD	40	-	nCK	
DQS/DQS# delay after write leveling mode is programmed	tWLDQSEN	25	-	nCK	
Write leveling setup time from rising CK, CK# crossing to rising DQS, DQS# crossing	tWLS	195	-	ps	
Write leveling hold time from rising DQS, DQS# crossing to rising CK, CK# crossing	tWLH	195	-	ps	
Write leveling output delay	tWLO	0	9	ns	
Write leveling output error	tWLOE	0	2	ns	

NT2GC72B89B0NJ/NT2GC72B89B2NJ/NT2GC72C89B0NJ/NT2GC72C89B2NJ
 NT4GC72B4PB0NL/NT4GC72C4PB0NL/NT4GC72C4PB2NL/NT4GC72B8PB0NL/NT4GC72C8PB0NL/NT4GC72C8PB2NL
 NT8GC72B4NB1NJ/NT8GC72B4NB3NJ/NT8GC72C4NB1NJ/NT8GC72C4NB3NJ
 NT16TC72B4NB1NL/NT16TC72C4NB1NL/NT16TC72C4NB3NL



2GB: 256M x 72 / 4GB: 512M x 72 / 8GB: 1G x 72 / 16GB: 2G x 72
PC3-8500 / PC3-10600
Registered DDR3 SDRAM DIMM

Package Dimensions

[2GB – 1 Rank, 256Mx8 DDR3 SDRAMs]

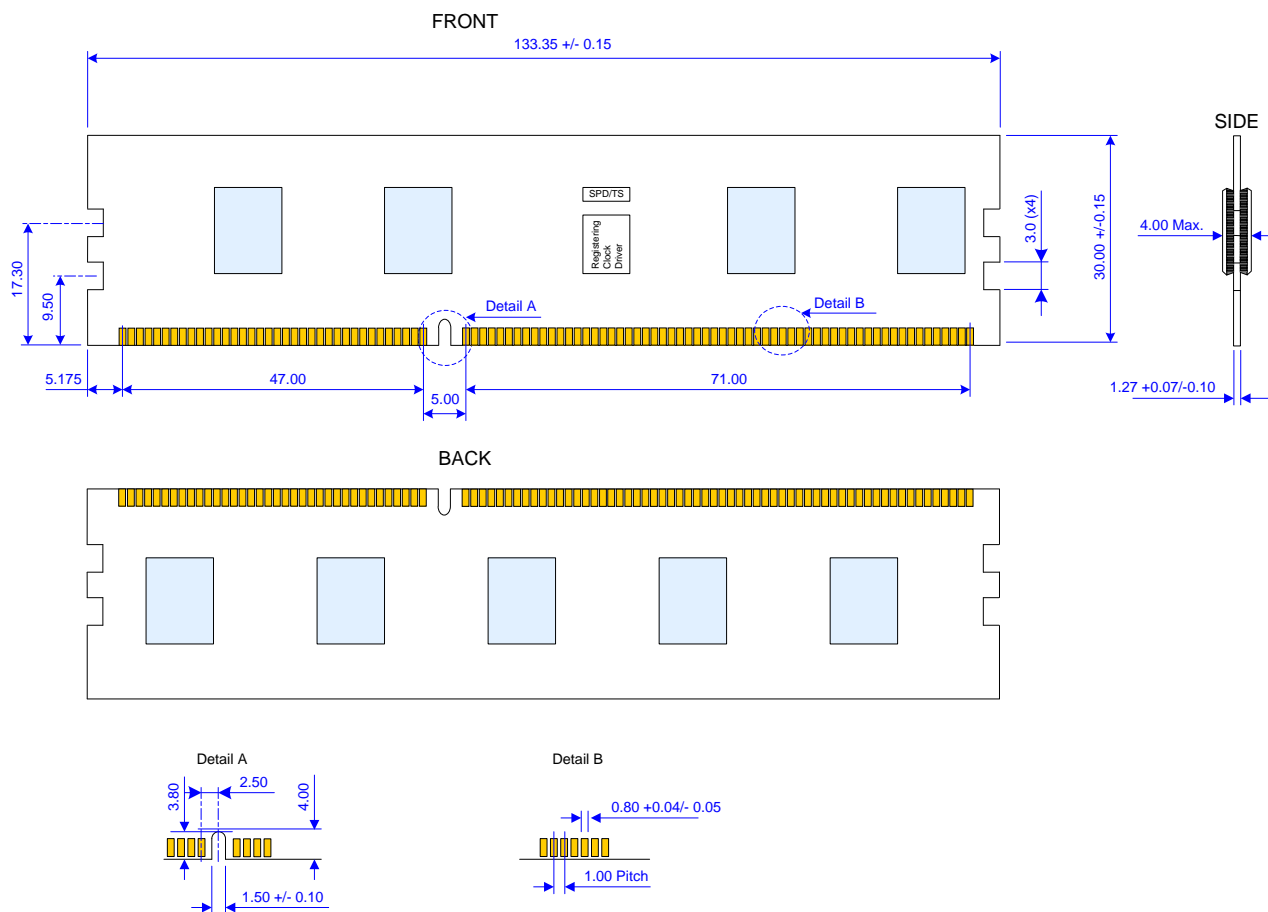

Units: Millimeters

Note: Device position and scale are only for reference.

NT2GC72B89B0NJ/NT2GC72B89B2NJ/NT2GC72C89B0NJ/NT2GC72C89B2NJ
 NT4GC72B4PB0NL/NT4GC72C4PB0NL/NT4GC72C4PB2NL/NT4GC72B8PB0NL/NT4GC72C8PB0NL/NT4GC72C8PB2NL
 NT8GC72B4NB1NJ/NT8GC72B4NB3NJ/NT8GC72C4NB1NJ/NT8GC72C4NB3NJ
 NT16TC72B4NB1NL/NT16TC72C4NB1NL/NT16TC72C4NB3NL



2GB: 256M x 72 / 4GB: 512M x 72 / 8GB: 1G x 72 / 16GB: 2G x 72
PC3-8500 / PC3-10600
Registered DDR3 SDRAM DIMM

Package Dimensions

[4GB – 1 Rank, 512Mx4 DDR3 SDRAMs]

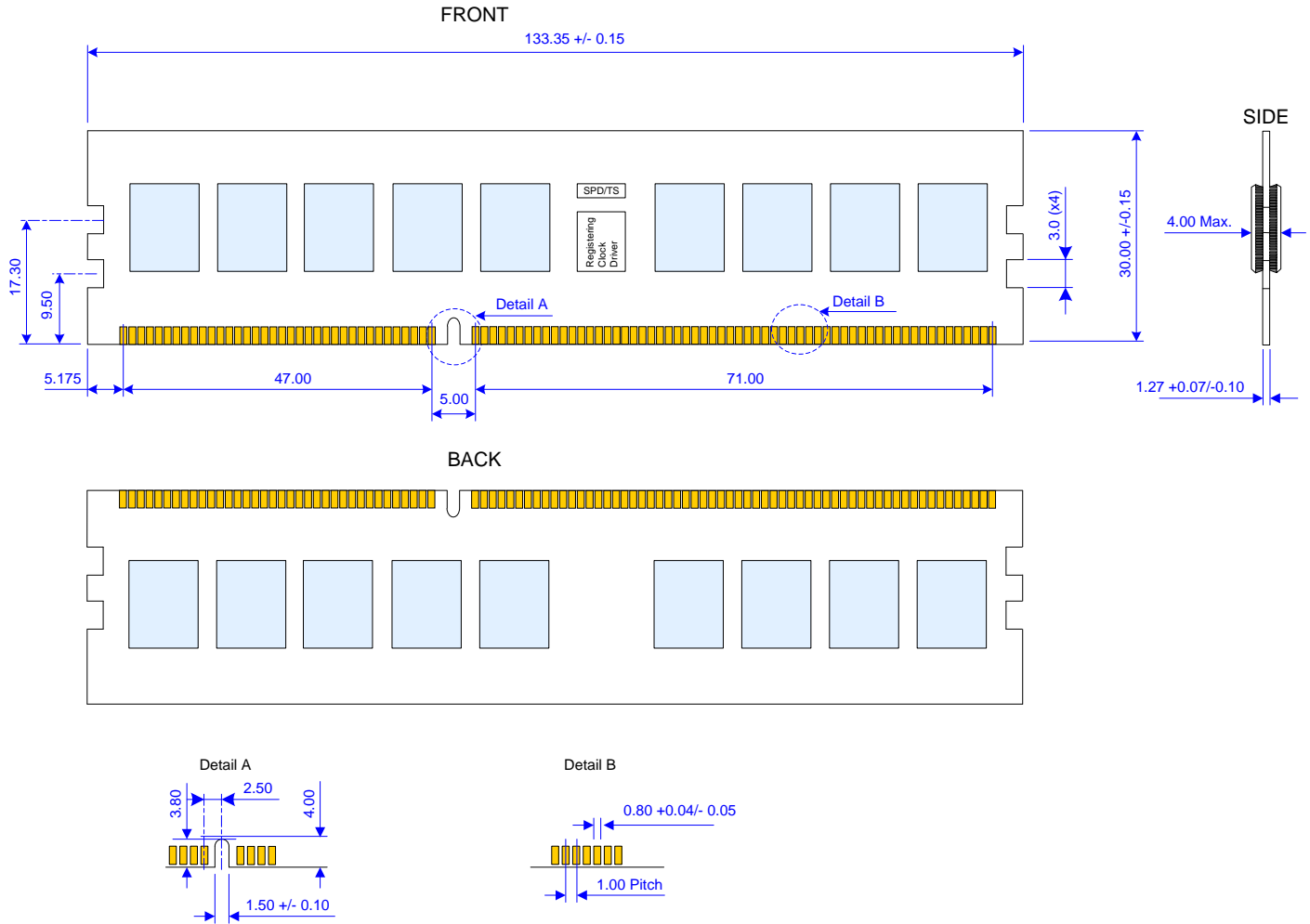

Units: Millimeters

Note: Device position and scale are only for reference.

NT2GC72B89B0NJ/NT2GC72B89B2NJ/NT2GC72C89B0NJ/NT2GC72C89B2NJ
 NT4GC72B4PB0NL/NT4GC72C4PB0NL/NT4GC72C4PB2NL/NT4GC72B8PB0NL/NT4GC72C8PB0NL/NT4GC72C8PB2NL
 NT8GC72B4NB1NJ/NT8GC72B4NB3NJ/NT8GC72C4NB1NJ/NT8GC72C4NB3NJ
 NT16TC72B4NB1NL/NT16TC72C4NB1NL/NT16TC72C4NB3NL



2GB: 256M x 72 / 4GB: 512M x 72 / 8GB: 1G x 72 / 16GB: 2G x 72
PC3-8500 / PC3-10600
Registered DDR3 SDRAM DIMM

Package Dimensions

[8GB – 2 Ranks, 512Mx4 DDR3 SDRAMs without H/S]

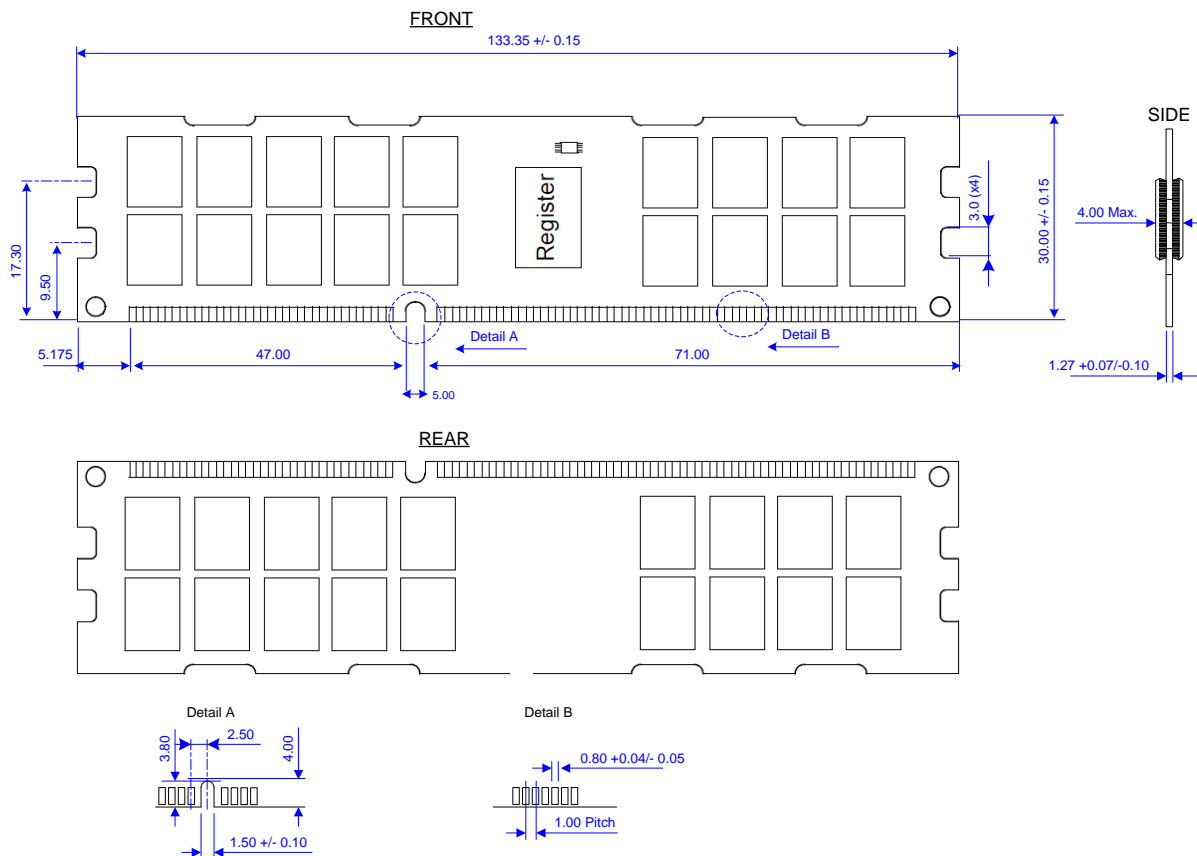

Units: Millimeters

Note: Device position and scale are only for reference.

NT2GC72B89B0NJ/NT2GC72B89B2NJ/NT2GC72C89B0NJ/NT2GC72C89B2NJ
 NT4GC72B4PB0NL/NT4GC72C4PB0NL/NT4GC72C4PB2NL/NT4GC72B8PB0NL/NT4GC72C8PB0NL/NT4GC72C8PB2NL
 NT8GC72B4NB1NJ/NT8GC72B4NB3NJ/NT8GC72C4NB1NJ/NT8GC72C4NB3NJ
 NT16T72B4NB1NL/NT16T72C4NB1NL/NT16T72C4NB3NL



2GB: 256M x 72 / 4GB: 512M x 72 / 8GB: 1G x 72 / 16GB: 2G x 72
PC3-8500 / PC3-10600
Registered DDR3 SDRAM DIMM

Package Dimensions

[8GB – 2 Ranks, 512Mx4 DDR3 SDRAMs with H/S]

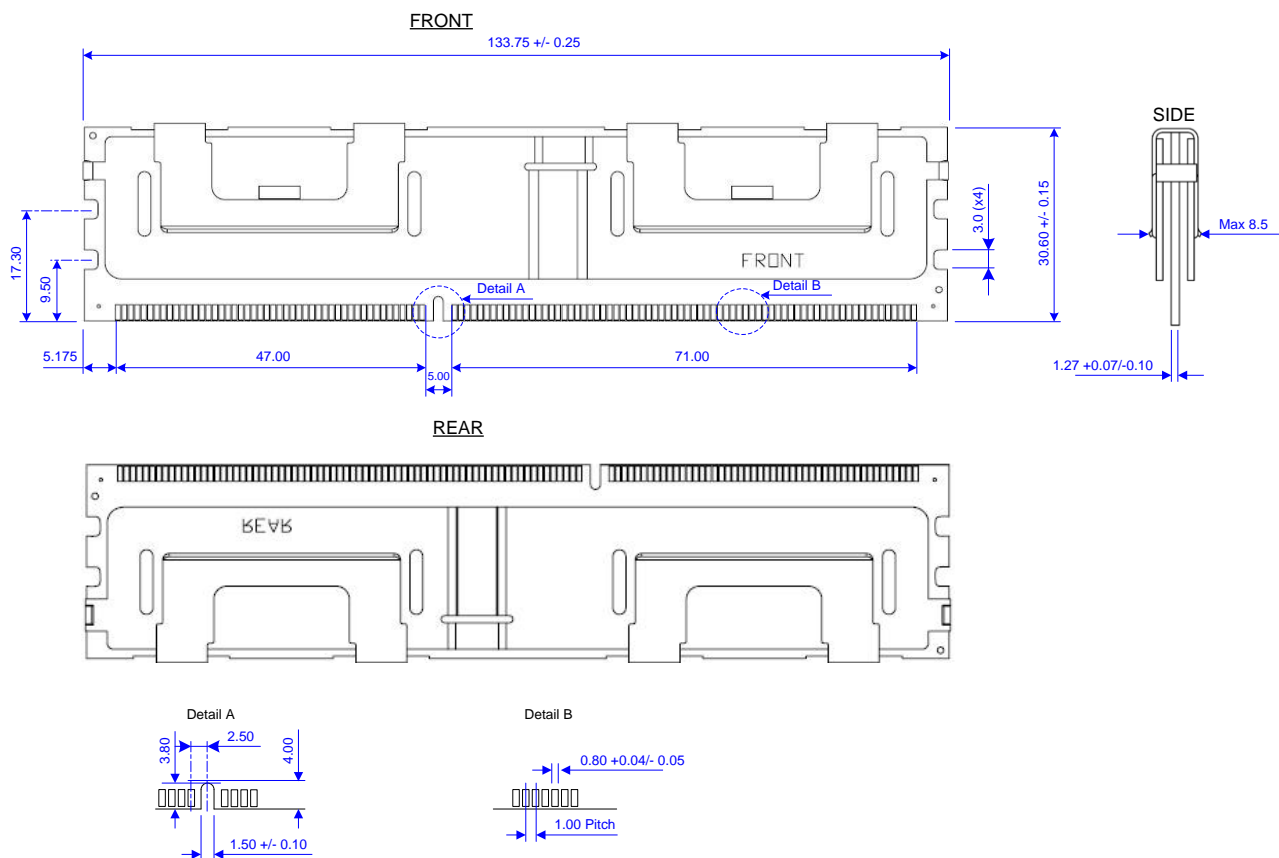

Units: Millimeters

Note: Device position and scale are only for reference.

NT2GC72B89B0NJ/NT2GC72B89B2NJ/NT2GC72C89B0NJ/NT2GC72C89B2NJ
 NT4GC72B4PB0NL/NT4GC72C4PB0NL/NT4GC72C4PB2NL/NT4GC72B8PB0NL/NT4GC72C8PB0NL/NT4GC72C8PB2NL
 NT8GC72B4NB1NJ/NT8GC72B4NB3NJ/NT8GC72C4NB1NJ/NT8GC72C4NB3NJ
 NT16TC72B4NB1NL/NT16TC72C4NB1NL/NT16TC72C4NB3NL



2GB: 256M x 72 / 4GB: 512M x 72 / 8GB: 1G x 72 / 16GB: 2G x 72
PC3-8500 / PC3-10600
Registered DDR3 SDRAM DIMM

Package Dimensions

[16GB – 4 Ranks, 1Gx4 (DDP) DDR3 SDRAMs]

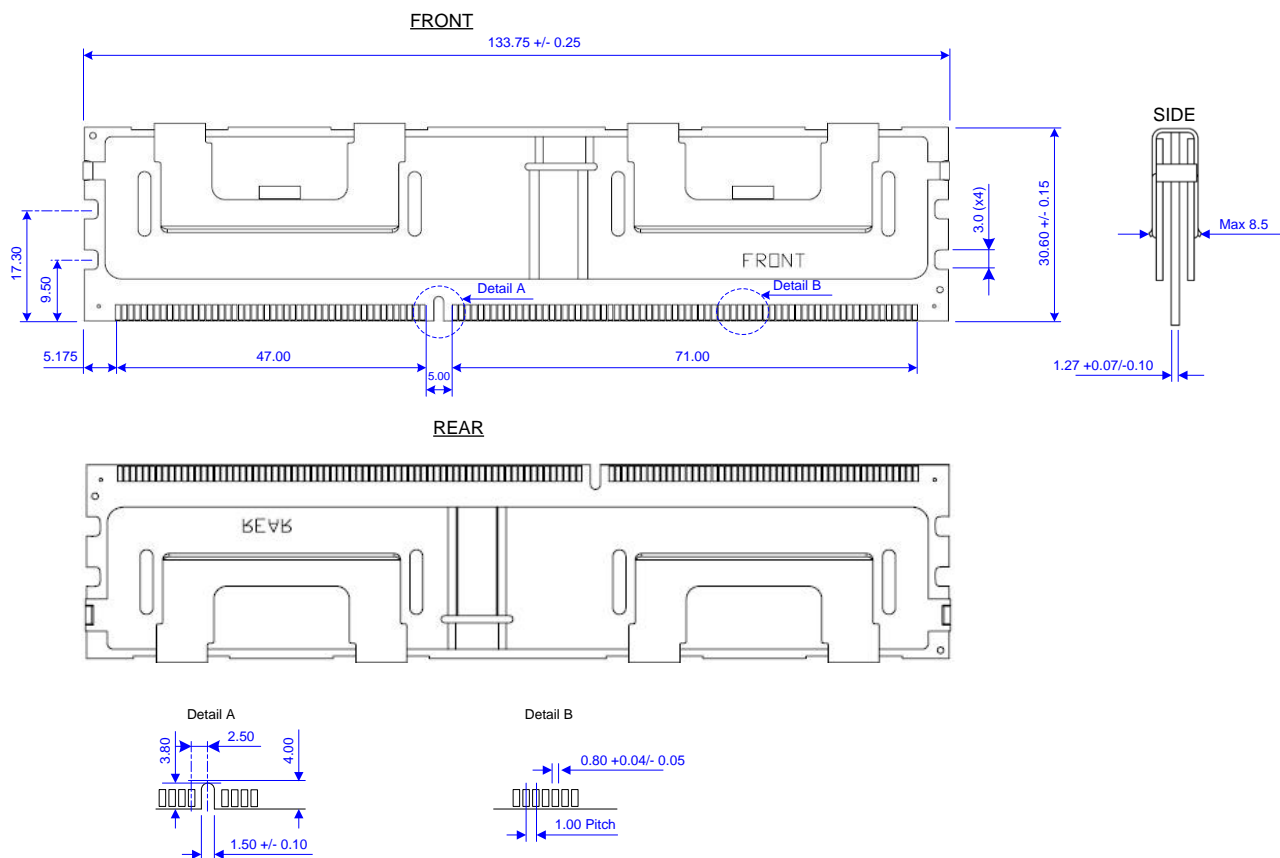

Units: Millimeters

Note: Device position and scale are only for reference.

NT2GC72B89B0NJ/NT2GC72B89B2NJ/NT2GC72C89B0NJ/NT2GC72C89B2NJ
NT4GC72B4PB0NL/NT4GC72C4PB0NL/NT4GC72C4PB2NL/NT4GC72B8PB0NL/NT4GC72C8PB0NL/NT4GC72C8PB2NL
NT8GC72B4NB1NJ/NT8GC72B4NB3NJ/NT8GC72C4NB1NJ/NT8GC72C4NB3NJ
NT16TC72B4NB1NL/NT16TC72C4NB1NL/NT16TC72C4NB3NL

2GB: 256M x 72 / 4GB: 512M x 72 / 8GB: 1G x 72 / 16GB: 2G x 72
PC3-8500 / PC3-10600
Registered DDR3 SDRAM DIMM



Revision Log

Rev	Date	Modification
0.1	02/2010	Preliminary Release
0.5	05/2010	Preliminary Release 2
1.0	08/2010	Official Release
1.1	11/2010	Added 1.35V Spec. and modify Functional Block Diagram of 1Rx4.
1.2	12/2010	Added Package Dimensions of 8GB without Heat Sink.

Nanya Technology Corporation

Hwa Ya Technology Park 669

Fu Hsing 3rd Rd., Kueishan,

Taoyuan, 333, Taiwan, R.O.C.

Tel: +886-3-328-1688

Please visit our home page for more information: www.nanya.com

Printed in Taiwan ©2010