

About EZ Form

Cable Corporation, Inc.



EZ Form Cable Corporation has long been a leader in the field of miniature coaxial cable, pioneering such products as:

- The first soft-jacketed copper semi-rigid cable;
- The first MIL-C-17 QPL aluminum-jacketed semi-rigid cable;
- EZFlex Formable™ hand-formable cable;
- EZFlex™ 401, 402, and 405 flexible cable, with performance rivalling semi-rigid cable.
- EZArmored Ruggedized cable which incorporates our line of EZFlex cable with a nearly indestructible armor jacket.

EZ Form miniature coaxial cables have been proven in hundreds of critical applications, including:

- *low-noise amplifiers,*
- *microwave components,*
- *space applications,*
- *high-speed computers,*
- *wireless/cellular communications systems,*
- *high-performance instrumentation.*

These cables provide extreme flexibility and greatly extended mechanical parameters. Each series of cable offers uniquely favorable electrical characteristics, such as an impedance tolerance as low as $\pm 1/2$ ohm for most 50 Ω cables.

EZ Form copper and aluminum jacketed semi-rigid cables are qualified to MIL-C-17. The cables exceed all federal and military specifications for procurement, manufacture and testing.

Utilizing our cable with its superior characteristics, EZ Form produces a variety of custom cable assemblies and delay lines which meet our customer's most stringent electrical and mechanical specifications.

In this catalog, EZ Form is also featuring our line of RF coaxial connectors, in standard series such as SMA, SMB, SMC, BNC, TNC, N and MCX, in-and-between series adapters and our EZ Quick Snap push-on connector system.

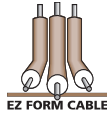

Contents

Section I – Cable Products

EZ Form Semi-Rigid Cables

Copper-jacketed semi-rigid cables	4
Aluminum-jacketed semi-rigid cables	6
MIL-C-17 semi-rigid cables (QPL items)	8

EZFlex™ Cables

EZFlex™ 401, 402, and 405 flexible cables	10
---	----

EZFlex Formable™ Cables

EZFlex 250, 141, 86, 47 and 34 hand-formable cable.....	11
---	----

Cable Assemblies

Cable assemblies—Overview	12
Standard cable assemblies.....	13
EZArmored Ruggedized cable assemblies.....	14
Swept right angle assemblies	15

Delay Lines

Delay lines—Overview.....	16
Standard delay lines	17

Competitive Cable Cross-Reference List and General Notes

Cable Types and Part Number Index

Section II – RF Coaxial Connectors

Table of contents	2
Connectors.....	3
Connector part number index	60

Section III – Product Highlights

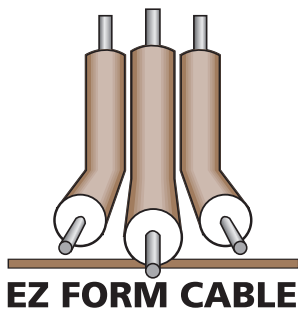

EZ Form Cable Corporation

285 Welton Street
Hamden, CT 06517

(203) 785-8215

FAX (203) 785-0466

e-mail: sales@ezform.com

www.ezform.com

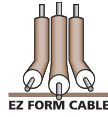

Cable Products

Product Features:

- Two series of solid-jacketed semi-rigid (copper and aluminum), and two series of hand-formable cables: EZFlex™ (flexible) and EZFlex Formable™ (featuring a tinned braid outer conductor for 100% shielding)—a type to suit virtually every high-frequency requirement.
- Impedance tolerances as low as $\pm 1/2\Omega$.
- Minimum VSWR.
- Smooth attenuation vs. frequency curve.
- Easily formed; EZFlex cable withstands repeated flexing better than standard semi-rigid.
- Small size permits use in high-density applications.
- Light weight; EZ Form aluminum cable is 40% lighter than equivalent copper cable.
- Easy stripping, tinning, and soldering for convenient cabling.
- Minimum change in impedance and attenuation over temperature extremes.
- Minimum electrical length variation with temperature change.
- Sizes available from .034" to .500" outer conductor diameter.
- Lengths in excess of 150 feet.
- Any cable in this catalog is available as a "complete" cable assembly manufactured to your custom specifications with your choice of connectors and testing to your requirements. Phase Matching of assemblies is available to within 1 degree per GHz.
- Delay Lines are a specialty of EZ Form where we custom design them to your requirements while shaping them into almost any configuration required. Delay tolerance of $\pm 20\text{pS}$ are achieved.



Cable assembly and delay line manufacturing is a highly-developed art at EZ Form.



Our fully-equipped lab can perform comprehensive electrical testing from DC-40Ghz, along with a wide range of mechanical and environmental testing.

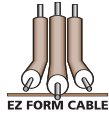

Copper-Jacketed

See page 8 for MIL-C-17 QPL Items

Part Number	Nominal Impedance (Ω)	Outer Conductor Diameter inches (mm)	Dielectric Diameter inches (mm)	Center Conductor Diameter inches (mm)
EZ 34	50.0 ±3.0	.034 (.86)	.026 (.66)	.008 (.20)
EZ 34-TP	50.0 ±3.0	.034 (.86)*	.026 (.66)	.008 (.20)
EZ 47/M17	50.0 ±2.5	.047 (1.19)	.037 (.94)	.0113 (.29)
EZ 47-TP/M17	50.0 ±2.5	.047 (1.19)*	.037 (.94)	.0113 (.29)
EZ 47-SP	50.0 ±2.5	.047 (1.19)*	.037 (.94)	.0113 (.29)
EZ 47-Cu	50.0 ±2.5	.047 (1.19)	.037 (.94)	.0113 (.29)
EZ 47-Cu-TP	50.0 ±2.5	.047 (1.19)*	.037 (.94)	.0113 (.29)
EZ 47-Cu-SP	50.0 ±2.5	.047 (1.19)*	.037 (.94)	.0113 (.29)
EZ 47-LA	50.0 ±2.5	.047 (1.19)	.037 (.94)	.0126 (.320)
EZ 47-LA-TP	50.0 ±2.5	.047 (1.19)*	.037 (.94)	.0126 (.320)
EZ 86/M17	50.0 ±1.5	.0865 (2.20)	.066 (1.676)	.0201 (.511)
EZ 86-SJ/M17	50.0 ±1.5	.0865 (2.20)	.066 (1.676)	.0201 (.511)
EZ 86-TP/M17	50.0 ±1.5	.0865 (2.20)*	.066 (1.676)	.0201 (.511)
EZ 86-SJ-TP/M17	50.0 ±1.5	.0865 (2.20)*	.066 (1.676)	.0201 (.511)
EZ 86-SP	50.0 ±1.5	.0865 (2.20)*	.066 (1.676)	.0201 (.511)
EZ 86-Cu/M17	50.0 ±1.5	.0865 (2.20)	.066 (1.676)	.0201 (.511)
EZ 86-Cu-SJ/M17	50.0 ±1.5	.0865 (2.20)	.066 (1.676)	.0201 (.511)
EZ 86-Cu-TP/M17	50.0 ±1.5	.0865 (2.20)*	.066 (1.676)	.0201 (.511)
EZ 86-Cu-TP-SJ/M17	50.0 ±1.5	.0865 (2.20)*	.066 (1.676)	.0201 (.511)
EZ 86-75	75.0 ±2.0	.0865 (2.20)	.066 (1.676)	.0113 (.29)
EZ 86-75-TP	75.0 ±2.0	.0865 (2.20)*	.066 (1.676)	.0113 (.29)
EZ 86-LA	50.0 ±1.5	.0865 (2.20)	.066 (1.676)	.0226 (.57)
EZ 86-LA-TP	50.0 ±1.5	.0865 (2.20)*	.066 (1.676)	.0226 (.57)
EZ 90-25-Cu	25.0 ±2.0	.090 (2.29)	.073 (1.85)	.0403 (1.02)
EZ 90-25-Cu-TP	25.0 ±2.0	.090 (2.29)*	.073 (1.85)	.0403 (1.02)
EZ 141/M17	50.0 ±1.0	.141 (3.58)	.1175 (2.98)	.0362 (.92)
EZ 141-SJ/M17	50.0 ±1.0	.141 (3.58)	.1175 (2.98)	.0362 (.92)
EZ 141-TP/M17	50.0 ±1.0	.141 (3.58)*	.1175 (2.98)	.0362 (.92)
EZ 141-TP-SJ/M17	50.0 ±1.0	.141 (3.58)*	.1175 (2.98)	.0362 (.92)
EZ 141-SP	50.0 ±1.0	.141 (3.58)*	.1175 (2.98)	.0362 (.92)
EZ 141-Cu	50.0 ±1.0	.141 (3.58)	.1175 (2.98)	.0362 (.92)
EZ 141-Cu-TP	50.0 ±1.0	.141 (3.58)*	.1175 (2.98)	.0362 (.92)
EZ 141-Cu-SP	50.0 ±1.0	.141 (3.58)*	.1175 (2.98)	.0362 (.92)
EZ 141-70	70.0 ±2.0	.141 (3.58)	.107 (2.72)	.0201 (.51)
EZ 141-70-TP	70.0 ±2.0	.141 (3.58)*	.107 (2.72)	.0201 (.51)
EZ 141-75	75.0 ±2.0	.141 (3.58)	.117 (2.97)	.0201 (.51)
EZ 141-75-TP	75.0 ±2.0	.141 (3.58)*	.117 (2.97)	.0201 (.51)
EZ 141-75-SP	75.0 ±2.0	.141 (3.58)*	.117 (2.97)	.0201 (.51)
EZ 141-75-Cu	75.0 ±2.0	.141 (3.58)	.117 (2.97)	.0201 (.51)
EZ 141-LA	50.0 ±1.0	.141 (3.58)	.118 (3.00)	.0403 (1.02)
EZ 141-LA-TP	50.0 ±1.0	.141 (3.58)*	.118 (3.00)	.0403 (1.02)
EZ 250/M17	50.0 ±0.5	.250 (6.35)	.209 (5.31)	.0641 (1.63)
EZ 250-TP/M17	50.0 ±0.5	.250 (6.35)*	.209 (5.31)	.0641 (1.63)
EZ 250-SP	50.0 ±0.5	.250 (6.35)*	.209 (5.31)	.0641 (1.63)
EZ 250-WP	50.0 ±1.0	.250 (6.35)	.209 (5.31)	.081 (2.06)
EZ 250-WP-TP	50.0 ±1.0	.250 (6.35)*	.209 (5.31)	.081 (2.06)
EZ 325	50.0 ±1.0	.325 (8.26)	.285 (7.24)	***
EZ 325-TP	50.0 ±1.0	.325 (8.26)*	.285 (7.24)	***

Notes

* Allow additional +.001" for plating.
 ** Contact factory for theoretical electrical parameters of non-50Ω cables.
 *** Stranded center conductor: 7 x .0132" (7 x .79 mm).
 † These cables meet the requirements of both MIL-C-17 types shown.
 Dimensional stability: .015/.038 max @ 125 °C.

Key to Materials

LA: Low Attenuation • TP: Tin Plated. • SJ: Soft Jacket.
 SP: Silver plated. • SPC: Silver-plated Copper.
 SPCW: Silver-plated Copper-clad steel.
 Outer Conductor: Copper per ASTM B88 or ASTM B447.
 Dielectric: Teflon TFE per ASTM-D-1457.
 Silver Plating: ASTM B700.
 Tin Plating: ASTM B545.

Electrical Specifications

Velocity of Propagation: 69.5% for standard cables;
 76.5% for LA; 84.5% for WP

Temperature Range:

See page 8 for Temperature Ranges.

Semi-Rigid Cable

Low-loss cables shown in **bold**

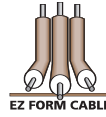

For RoHS Compliant Cables, please contact factory.

Center Conductor Material	Weight (Max)		Center Conductor Adhesion		Capacitance (Maximum) pf/ft (pf/m)	Continuous Working Voltage (VRMS Max)	Voltage Withstand (VRMS)	Maximum Operating Frequency (GHz)			
	lbs/100 ft (kg/100m)		lbs (N)	Min Max							
SPCW	.26	(.39)	.5	(2.2)	3.5	(15.5)	32.0	(105)	750	2000	20
SPCW	.28	(.42)	.5	(2.2)	3.5	(15.5)	32.0	(105)	750	2000	20
SPCW	.45	(.67)	2	(8.9)	10	(44.5)	32.0	(105)	1000	2000	20
SPCW	.48	(.71)	2	(8.9)	10	(44.5)	32.0	(105)	1000	2000	20
SPCW	.48	(.71)	2	(8.9)	10	(44.5)	32.0	(105)	1000	2000	20
SPC	.45	(.67)	2	(8.9)	10	(44.5)	32.0	(105)	1000	2000	20
SPC	.48	(.71)	2	(8.9)	10	(44.5)	32.0	(105)	1000	2000	20
SPC	.48	(.71)	2	(8.9)	10	(44.5)	32.0	(105)	1000	2000	20
SPC	.36	(.54)	2	(8.9)	10	(44.5)	24.0	(78.7)	1000	2000	110
SPC	.39	(.58)	2	(8.9)	10	(44.5)	24.0	(78.7)	1000	2000	110
SPCW	1.53	(2.28)	4	(17.8)	25	(111)	32.0	(105)	1500	5000	20
SPCW	1.53	(2.28)	4	(17.8)	25	(111)	32.0	(105)	1500	5000	20
SPCW	1.58	(2.35)	4	(17.8)	25	(111)	32.0	(105)	1500	5000	20
SPCW	1.58	(2.35)	4	(17.8)	25	(111)	32.0	(105)	1500	5000	20
SPCW	1.58	(2.35)	4	(17.8)	25	(111)	32.0	(105)	1500	5000	20
SPC	1.52	(2.26)	4	(17.8)	25	(111)	32.0	(105)	1500	5000	20
SPC	1.52	(2.26)	4	(17.8)	25	(111)	32.0	(105)	1500	5000	20
SPC	1.57	(2.34)	4	(17.8)	25	(111)	32.0	(105)	1500	5000	20
SPC	1.57	(2.34)	4	(17.8)	25	(111)	32.0	(105)	1500	5000	20
SPCW	1.50	(2.25)	2	(8.9)	25	(111)	19.4	(63.5)	1200	2500	65
SPCW	1.58	(2.35)	2	(8.9)	25	(111)	19.4	(63.5)	1200	2500	65
SPC	1.53	(2.28)	2	(8.9)	25	(111)	27.2	(89.2)	1500	2500	61
SPC	1.58	(2.35)	2	(8.9)	25	(111)	27.2	(89.2)	1500	2500	61
SPC	1.60	(2.38)	4	(17.8)	35	(156)	57.6	(189)	750	1000	46
SPC	1.60	(2.38)	4	(17.8)	35	(156)	57.6	(189)	750	1000	46
SPCW	3.44	(5.12)	4	(17.8)	65	(289)	29.9	(98.1)	1900	5000	20
SPCW	3.44	(5.12)	4	(17.8)	65	(289)	29.9	(98.1)	1900	5000	20
SPCW	3.50	(5.21)	4	(17.8)	65	(289)	29.9	(98.1)	1900	5000	20
SPCW	3.50	(5.21)	4	(17.8)	65	(289)	29.9	(98.1)	1900	5000	20
SPCW	3.50	(5.21)	4	(17.8)	65	(289)	29.9	(98.1)	1900	5000	20
SPC	3.43	(5.11)	4	(17.8)	65	(289)	29.9	(98.1)	1900	5000	20
SPC	3.50	(5.21)	4	(17.8)	65	(289)	29.9	(98.1)	1900	5000	20
SPC	3.50	(5.21)	4	(17.8)	65	(289)	29.9	(98.1)	1900	5000	20
SPCW	3.45	(5.13)	2	(8.9)	65	(289)	20.6	(67.6)	2000	5000	41
SPCW	3.51	(5.22)	2	(8.9)	65	(289)	20.6	(67.6)	2000	5000	41
SPCW	3.45	(5.13)	2	(8.9)	65	(289)	19.4	(63.6)	2000	5000	38
SPCW	3.51	(5.22)	2	(8.9)	65	(289)	19.4	(63.6)	2000	5000	38
SPCW	3.51	(5.22)	2	(8.9)	65	(289)	19.4	(63.6)	2000	5000	38
SPC	3.45	(5.13)	2	(8.9)	65	(289)	19.4	(63.6)	2000	5000	38
SPC	3.44	(5.21)	2	(8.9)	65	(289)	27.1	(88.7)	1900	5000	34
SPC	3.50	(5.21)	2	(8.9)	65	(289)	27.1	(88.7)	1900	5000	34
SPC	10.5	(15.6)	4	(17.8)	100	(445)	29.6	(97.1)	3000	7500	18
SPC	10.6	(15.8)	4	(17.8)	100	(445)	29.6	(97.1)	3000	7500	18
SPC	10.6	(15.8)	4	(17.8)	100	(445)	29.6	(97.1)	3000	7500	18
SPC	9.07	(13.5)	2	(8.9)	100	(445)	25.0	(82.0)	3000	7500	20
SPC	9.17	(13.6)	2	(8.9)	100	(445)	25.0	(82.0)	3000	7500	20
SPC	14.5	(21.6)	2	(8.9)	100	(445)	29.0	(95.1)	3000	7500	14
SPC	14.7	(21.9)	2	(8.9)	100	(445)	29.0	(95.1)	3000	7500	14

Maximum Attenuation and Power Ratings (@ 25 °C)*														
.250 diameter			.141 diameter			.086 diameter			.047 diameter			.034 diameter		
Attenuation		Power	Attenuation		Power	Attenuation		Power	Attenuation		Power	Attenuation		Power
MHz	dB/100 ft.	Watts	MHz	dB/100 ft.	Watts	MHz	dB/100 ft.	Watts	MHz	dB/100 ft.	Watts	MHz	dB/100 ft.	Watts
400	4.5	1900	500	8	600	500	15	180	500	28	45	500	42	14
1000	7.5	1400	1000	12	450	1000	22	130	1000	40	32	1000	60	10
3000	16	750	5000	29	180	5000	50	54	5000	90	13	5000	140	4.5
10000	33	350	10000	45	120	10000	80	35	10000	130	9	10000	190	3.1
18000	48	200	20000	70	70	20000	130	20	20000	190	6.5	20000	280	2
Structural Return Loss			Structural Return Loss			Structural Return Loss			Structural Return Loss			Structural Return Loss		
MHz	dB		MHz	dB		MHz	dB		MHz	dB		MHz	dB	
500	26		500	30		500	28		1000	22		500	22	
5000	21		5000	23		5000	23		10000	18		5000	21	
18000	16		18000	21		20000	15		20000	14		20000	15	

* Contact factory for attenuation, power ratings and return loss values of low attenuation cables.

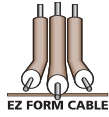

Aluminum-jacketed

See page 8 for MIL-C-17 QPL Items

Part Number	Nominal Impedance (Ω)	Outer Conductor Diameter inches (mm)	Dielectric Diameter inches (mm)	Center Conductor Diameter inches (mm)
EZ 47AL	50.0 \pm 2.5	.047 (1.19)	.037 (.94)	.0113 (.287)
EZ 47AL-TP	50.0 \pm 2.5	.047 (1.19)*	.037 (.94)	.0113 (.287)
EZ 47AL-LA	50.0 \pm2.5	.047 (1.19)	.037 (.94)	.0126 (.32)
EZ 47AL-LA-TP	50.0 \pm2.5	.047 (1.19)*	.037 (.94)	.0126 (.32)
EZ 86AL/M17	50.0 \pm 1.5	.0865 (2.2)	.066 (1.68)	.0201 (.51)
EZ 86AL-TP/M17	50.0 \pm 1.5	.0865 (2.2)*	.066 (1.68)	.0201 (.51)
EZ 86AL-SP	50.0 \pm 1.5	.0865 (2.2)*	.066 (1.68)	.0201 (.51)
EZ 86AL-LA	50.0 \pm1.5	.0865 (2.2)	.066 (1.68)	.0226 (.57)
EZ 86AL-LA-TP	50.0 \pm1.5	.0865 (2.2)*	.066 (1.68)	.0226 (.57)
EZ 86-75AL	75.0 \pm 2.0	.0865 (2.2)	.066 (1.68)	.0113 (.29)
EZ 86-75AL-TP	75.0 \pm 2.0	.0865 (2.2)*	.066 (1.68)	.0113 (.29)
EZ 141AL/M17	50.0 \pm 1.0	.141 (3.58)	.1175 (2.98)	.0362 (.92)
EZ 141AL-TP/M17	50.0 \pm 1.0	.141 (3.58)*	.1175 (2.98)	.0362 (.92)
EZ 141AL-SP	50.0 \pm 1.0	.141 (3.58)*	.1175 (2.98)	.0362 (.92)
EZ 141AL-LA	50.0 \pm1.0	.141 (3.58)	.118 (3.00)	.0403 (1.02)
EZ 141AL-LA-TP	50.0 \pm1.0	.141 (3.58)*	.118 (3.00)	.0403 (1.02)
EZ 141-100-AL	100.0 \pm 2.5	.141 (3.58)	.109 (2.77)	.0100 (.25)
EZ 141-100-AL-TP	100.0 \pm 2.5	.141 (3.58)*	.109 (2.77)	.0100 (.25)
EZ 141-75-AL	75.0 \pm 2.0	.141 (3.58)	.117 (2.97)	.0201 (.51)
EZ 141-75-AL-TP	75.0 \pm 2.0	.141 (3.58)*	.117 (2.97)	.0201 (.51)
EZ 141-70-AL	70.0 \pm 2.0	.141 (3.58)	.107 (2.72)	.0201 (.51)
EZ 141-70-AL-TP	70.0 \pm 2.0	.141 (3.58)*	.107 (2.72)	.0201 (.51)
EZ 250AL	50.0 \pm 0.5	.250 (6.35)	.209 (5.31)	.0641 (1.63)
EZ 250AL-TP	50.0 \pm 0.5	.250 (6.35)*	.209 (5.31)	.0641 (1.63)
EZ 250AL-WP	50.0 \pm1.0	.250 (6.35)	.209 (5.31)	.081 (2.06)
EZ 250AL-WP-TP	50.0 \pm1.0	.250 (6.35)*	.209 (5.31)	.081 (2.06)

*Allow additional \pm .001 for plating.

** Contact factory for theoretical electrical parameters of non-50 Ω cables.

Key to Materials

TP: Tin Plated
 SP: Silver plated
 SPC: Silver-plated Copper
 SPCW: Silver-plated Copper-clad steel
LA: Low Attenuation WP: Wrap Dielectric

Outer Conductor: Aluminum per ASTM B483
 Dielectric: Teflon TFE per ASTM-D-1457
 Silver Plating: ASTM B700
 Tin Plating: ASTM B545

Electrical Specifications

Velocity of Propagation: 69.5% for standard cables;
 76.5% for LA; 84.5% for WP

Temperature Range:

See page 8 for Temperature Ranges

Semi-Rigid Cable

Low-loss cables shown in **bold**

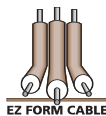

For RoHS Compliant Cables, please contact factory.

Center Conductor Material	Weight (Max) lbs/100 ft (kg/100m)	Center Conductor Adhesion lbs (N)		Capacitance (Maximum) pf/ft (pf/m)	Continuous Working Voltage (VRMS Max)	Voltage Withstand (VRMS)	Maximum Operating Frequency (GHz)
		Min	Max				
SPCW	.23 (.34)	2 (8.9)	10 (44.5)	32.0 (105)	1000	2000	104
SPCW	.24 (.36)	2 (8.9)	10 (44.5)	32.0 (105)	1000	2000	104
SPC	.17 (.25)	2 (8.9)	10 (44.5)	24.0 (78.7)	1000	2000	110
SPC	.18 (.26)	2 (8.9)	10 (44.5)	24.0 (78.7)	1000	2000	110
SPCW	.75 (1.12)	4 (17.8)	25 (111)	32.0 (105)	1500	5000	20
SPCW	.80 (1.19)	4 (17.8)	25 (111)	32.0 (105)	1500	5000	20
SPCW	.80 (1.19)	4 (17.8)	25 (111)	32.0 (105)	1500	5000	57
SPC	.63 (.94)	2 (8.9)	25 (111)	27.2 (89.2)	1500	5000	61
SPC	.68 (1.01)	2 (8.9)	25 (111)	27.2 (89.2)	1500	5000	61
SPCW	.75 (1.12)	2 (8.9)	25 (111)	19.4 (63.7)	1200	2500	65
SPCW	.80 (1.19)	2 (8.9)	25 (111)	19.4 (63.7)	1200	2500	65
SPCW	1.98 (2.95)	4 (17.8)	65 (289)	29.9 (98.1)	1900	5000	20
SPCW	2.05 (3.05)	4 (17.8)	65 (289)	29.9 (98.1)	1900	5000	20
SPCW	2.05 (3.05)	4 (17.8)	65 (289)	29.9 (98.1)	1900	5000	32
SPC	1.61 (2.40)	2 (8.9)	65 (289)	27.1 (88.7)	1900	5000	34
SPC	1.67 (2.49)	2 (8.9)	65 (289)	27.1 (88.7)	1900	5000	34
SPCW	1.90 (2.83)	2 (8.9)	65 (289)	14.6 (47.9)	2000	5000	42
SPCW	1.97 (2.93)	2 (8.9)	65 (289)	14.6 (47.9)	2000	5000	42
SPCW	1.79 (2.66)	2 (8.9)	65 (289)	19.4 (63.7)	2000	5000	36
SPCW	1.86 (2.77)	2 (8.9)	65 (289)	19.4 (63.7)	2000	5000	36
SPCW	1.80 (2.68)	2 (8.9)	65 (289)	20.6 (67.6)	2000	5000	39
SPCW	1.87 (2.78)	2 (8.9)	65 (289)	20.6 (67.6)	2000	5000	39
SPC	6.30 (9.37)	4 (17.8)	100 (445)	29.6 (97.1)	3000	7500	18
SPC	6.40 (9.52)	4 (17.8)	100 (445)	29.6 (97.1)	3000	7500	18
SPC	4.90 (7.29)	2 (8.9)	100 (445)	25.0 (82.0)	3000	7500	20
SPC	4.91 (7.31)	2 (8.9)	100 (445)	25.0 (82.0)	3000	7500	20

Maximum Attenuation and Power Ratings (@ 25 °C)*											
.250 diameter			.141 diameter			.086 diameter			.047 diameter		
Attenuation		Power Watts	Attenuation		Power Watts	Attenuation		Power Watts	Attenuation		Power Watts
MHz	dB/100 ft.		MHz	dB/100 ft.		MHz	dB/100 ft.		MHz	dB/100 ft.	
400	4.5	962	500	8	439	500	15	130	500	28	45
1000	7.5	661	1000	12	306	1000	22	97	1000	40	32
5000	22	265	5000	29	128	5000	50	40	5000	90	13
10000	33	174	10000	45	87	10000	80	26	10000	130	9
18000	48	100	20000	70	58	20000	130	15	20000	190	6.5
Structural Return Loss			Structural Return Loss			Structural Return Loss			Structural Return Loss		
MHz	dB		MHz	dB		MHz	dB		MHz	dB	
500	26		500	30		500	28		1000	22	
5000	21		5000	23		5000	23		10000	18	
18000	16		18000	21		20000	15		20000	14	

* Contact factory for attenuation, power ratings and return loss values of low attenuation cables.

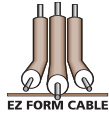

MIL-C-17-QPL

See page 4 for Copper-Jacketed Commercial Versions

MIL-C-17 Part Number Designation	Nominal Impedance (Ohms)	Outer Conductor Diameter inches (mm)	Outer Conductor Material	Outer Conductor Plating	Dielectric Diameter inches (mm)	Center Conductor Diameter inches (mm)
M17/129-RG-401	50.0 +/- 0.5	.250 (6.35)	CU	n/a	.209 (5.31)	.0641 (1.63)
M17/129-00001	50.0 +/- 0.5	.250 (6.35)*	CU	TP	.209 (5.31)	.0641 (1.63)
M17/130-RG402	50.0 +/- 1.0	.141 (3.58)	CU	n/a	.1175 (2.98)	.0362 (.92)
M17/130-00001	50.0 +/- 1.0	.141 (3.58)*	CU	TP	.1175 (2.98)	.0362 (.92)
M17/130-00004	50.0 +/- 1.0	.141 (3.58)	CU	n/a	.1175 (2.98)	.0362 (.92)
M17/130-00005	50.0 +/- 1.0	.141 (3.58)*	CU	TP	.1175 (2.98)	.0362 (.92)
M17/130-00008	50.0 +/- 1.0	.141 (3.58)	AL	n/a	.1175 (2.98)	.0362 (.92)
M17/130-00009	50.0 +/- 1.0	.141 (3.58)*	AL	TP	.1175 (2.98)	.0362 (.92)
M17/130-00012	50.0 +/- 1.0	.141 (3.58)*	CU	SP	.1175 (2.98)	.0362 (.92)
M17/130-00014	50.0 +/- 1.0	.141 (3.58)*	CU	TL	.1175 (2.98)	.0362 (.92)
M17/130-00015	50.0 +/- 1.0	.141 (3.58)*	CU	TL	.1175 (2.98)	.0362 (.92)
M17/133-RG405	50.0 +/- 1.5	.0865 (2.20)	CU	n/a	.066 (1.68)	.0201 (.51)
M17/133-00001	50.0 +/- 1.5	.0865 (2.20)*	CU	TP	.066 (1.68)	.0201 (.51)
M17/133-00002	50.0 +/- 1.5	.0865 (2.20)	CU	n/a	.066 (1.68)	.0201 (.51)
M17/133-00003	50.0 +/- 1.5	.0865 (2.20)*	CU	TP	.066 (1.68)	.0201 (.51)
M17/133-00006	50.0 +/- 1.5	.0865 (2.20)	CU	n/a	.066 (1.68)	.0201 (.51)
M17/133-00007	50.0 +/- 1.5	.0865 (2.20)*	CU	TP	.066 (1.68)	.0201 (.51)
M17/133-00008	50.0 +/- 1.5	.0865 (2.20)	CU	n/a	.066 (1.68)	.0201 (.51)
M17/133-00009	50.0 +/- 1.5	.0865 (2.20)*	CU	TP	.066 (1.68)	.0201 (.51)
M17/133-00012	50.0 +/- 1.5	.0865 (2.20)	AL	n/a	.066 (1.68)	.0201 (.51)
M17/133-00013	50.0 +/- 1.5	.0865 (2.20)*	AL	TP	.066 (1.68)	.0201 (.51)
M17/133-00016	50.0 +/- 1.5	.0865 (2.20)*	CU	SP	.066 (1.68)	.0201 (.51)
M17/133-00018	50.0 +/- 1.0	.0865 (2.20)*	CU	TL	.066 (1.68)	.0201 (.51)
M17/151-00001	50.0 +/- 2.5	.047 (1.19)	CU	n/a	.037 (.94)	.0113 (.29)
M17/151-00002	50.0 +/- 2.5	.047 (1.19)*	CU	TP	.037 (.94)	.0113 (.29)
M17/154-00001	50.0 +/- 3.0	.034 (.86)	CU	n/a	.026 (.66)	.008 (.20)
M17/154-00002	50.0 +/- 3.0	.034 (.86)*	CU	TP	.026 (.66)	.008 (.20)

Key to Materials

CU: Copper
 AL: Aluminum
 TP: Tin Plated
 SP: Silver Plated
 TL: Tin-Lead Plated
 SPC Silver-Plated Copper
 SPCW: Silver Plated Copper-clad Steel

Copper per ASTM B88 or B447
 Aluminum per ASTM B483
 Tin-Plating: ASTM B545
 Silver-Plating: ASTM B700
 Tin-Lead Plating (90/10): SAE-AMS-P-81728
 Dielectric: Teflon TFE per ASTM-D-1457

Electrical Specifications

Velocity of Propagation: 69.5% for standard cables;
 76.5% for LA; 84.5% for WP

Temperature Range:

.034": "-55 +100C .047": "-55 to +100C
 .086": "-55 +125C .086"LA: "-55 to +250C
 .141": "-55 +125C .141"LA: "-55 to +250C
 .250": "-55 +125C .250"WP: "-55 to +200C

Semi-Rigid Cable

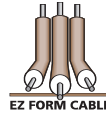

See page 6 for Aluminum-Jacketed Commercial Versions

Center Conductor Material	Weight (Max) lbs/100 ft (kg/100m)	Center Conductor Adhesion lbs (N)		Capacitance (Maximum) pf/ft (pf/m)	Continuous Working Voltage (VRMS Max)	Voltage Withstand (VRMS)	Maximum Operating Frequency (GHz)
		Min	Max				
SPC	10.5 (15.6)	4 (17.8)	100 (445)	29.6 (97.1)	3000	7500	18
SPC	10.6 (15.8)	4 (17.8)	100 (445)	29.6 (97.1)	3000	7500	18
SPCW	3.44 (5.12)	4 (17.8)	65 (289)	29.9 (98.1)	1900	5000	20
SPCW	3.50 (5.21)	4 (17.8)	65 (289)	29.9 (98.1)	1900	5000	20
SPCW	3.44 (5.12)	4 (17.8)	65 (289)	29.9 (98.1)	1900	5000	20
SPCW	3.50 (5.21)	4 (17.8)	65 (289)	29.9 (98.1)	1900	5000	20
SPCW	1.98 (2.95)	4 (17.8)	65 (289)	29.9 (98.1)	1900	5000	20
SPCW	2.05 (3.05)	4 (17.8)	65 (289)	29.9 (98.1)	1900	5000	20
SPCW	3.50 (5.21)	4 (17.8)	65 (289)	29.9 (98.1)	1900	1900	20
SPCW	3.50 (5.21)	4 (17.8)	65 (289)	29.9 (98.1)	1900	1900	20
SPC	3.50 (5.21)	4 (17.8)	65 (289)	29.9 (98.1)	1900	1900	20
SPCW	1.53 (2.28)	4 (17.8)	25 (111)	32.0 (105)	1500	5000	20
SPCW	1.58 (2.35)	4 (17.8)	25 (111)	32.0 (105)	1500	5000	20
SPC	1.52 (2.26)	4 (17.8)	25 (111)	32.0 (105)	1500	5000	20
SPC	1.57 (2.34)	4 (17.8)	25 (111)	32.0 (105)	1500	5000	20
SPCW	1.53 (2.28)	4 (17.8)	25 (111)	32.0 (105)	1500	5000	20
SPCW	1.58 (2.35)	4 (17.8)	25 (111)	32.0 (105)	1500	5000	20
SPC	1.52 (2.26)	4 (17.8)	25 (111)	32.0 (105)	1500	5000	20
SPC	1.57 (2.34)	4 (17.8)	25 (111)	32.0 (105)	1500	5000	20
SPCW	.80 (1.19)	4 (17.8)	25 (111)	32.0 (105)	1500	5000	20
SPCW	.80 (1.19)	4 (17.8)	25 (111)	32.0 (105)	1500	5000	20
SPCW	1.58 (2.35)	4 (17.8)	25 (111)	32.0 (105)	1500	5000	20
SPC	1.57 (2.34)	4 (17.8)	25 (111)	32.0 (105)	1500	5000	20
SPCW	.45 (.67)	2 (8.9)	10 (44.5)	32.0 (105)	1000	2000	20
SPCW	.48 (.71)	2 (8.9)	10 (44.5)	32.0 (105)	1000	2000	20
SPCW	.26 (.39)	.5 (2.2)	3.5 (15.5)	32.0 (105)	750	2000	20
SPCW	.28 (.42)	.5 (2.2)	3.5 (15.5)	32.0 (105)	750	2000	20

Maximum Attenuation and Power Ratings (@ 25 °C)*														
MIL-C-17/129			MIL-C-17/130			MIL-C-17/133			MIL-C-17/151			MIL-C-17/154		
Attenuation		Power	Attenuation		Power	Attenuation		Power	Attenuation		Power	Attenuation		Power
MHz	dB/100 ft.	Watts	MHz	dB/100 ft.	Watts	MHz	dB/100 ft.	Watts	MHz	dB/100 ft.	Watts	MHz	dB/100 ft.	Watts
400	4.5	1900	500	8	600	500	15	180	500	28	45	500	42	14
1000	7.5	1400	1000	12	450	1000	22	130	1000	40	32	1000	60	10
5000	22	750	5000	29	180	5000	50	54	5000	90	13	5000	140	4.5
10000	33	350	10000	45	120	10000	80	35	10000	130	9	10000	190	3.1
18000	48	200	20000	70	70	20000	130	20	20000	190	6.5	20000	280	2
Structural Return Loss			Structural Return Loss			Structural Return Loss			Structural Return Loss			Structural Return Loss		
MHz		dB	MHz		dB	MHz		dB	MHz		dB	MHz		dB
500		26	500		30	500		28	1000		22	500		22
5000		21	5000		23	5000		23	10000		18	5000		21
18000		16	18000		21	20000		15	20000		14	20000		15

For RoHS Compliant Cables, please contact factory.

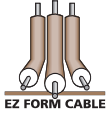

EZFlex 401, 402, and 405™

Truly flexible high-performance cable

New EZFlex 401, 402, and 405 have performance comparable to MIL-C-17 semi-rigid, yet handle like RG flexible cables and offer:

- Low leakage • Low VSWR • True flexibility • High durability • Lower weight

Let our dedicated assembly facility provide you with ready-made assemblies incorporating EZFlex 401, 402, or 405 and your choice of connectors for the ultimate in convenience—simply order the length you need and install in your system. See page 13 for standard assemblies.

Note: These cables are RoHS Compliant.

EZFlex 401, 402, and 405 Construction

Materials

Inner conductor: Solid silver-plated copperweld (also available with silver-plated copper center conductor).
Dielectric: Solid PTFE.
Inner Shield: Silver-plated copper/ Mylar laminate.
Outer shield: Silver-plated AWG 40 copper braid.
Outer Jacket: Extruded blue FEP.

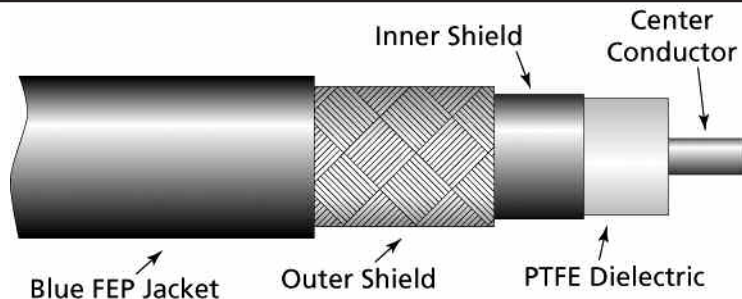

Specifications	EZFlex 401 (Equivalent to .250" semi-rigid)	EZFlex 402 (Equivalent to .141" semi-rigid)	EZFlex 405 (Equivalent to .086" semi-rigid)
Inner Conductor diameter, inches (mm)	.064 (1.63)	.036 (.914)	.0201 (.5105)
Dielectric diameter, inches (mm)	.209 (5.309)	.117 (2.972)	.066 (1.676)
Inner Shield diameter, inches (mm)	.217 (5.512)	.125 (3.175)	.074 (1.880)
Outer shield diameter, inches (mm)	.250 (6.35)	.141 (3.581)	.086 (2.184)
Outer Jacket diameter, inches (mm)	.265 (6.731)	.163 (4.140)	.100 (2.54)
Minimum Bend Radius, inches (mm)	.500 (12.7)	.200 (5.08)	.125 (3.18)
Weight, lbs/100 ft. (kg/100 m)	7.7 (11.5)	3.0 (4.5)	1.4 (2.1)
Operating Temperature	-65 to 200° C	-65 to 200° C	-65 to 200° C
Impedance	50 ±2Ω	50 ±2Ω	50 ±2Ω
Velocity of Propagation	70%	70%	70%
Dielectric Constant	2.04	2.04	2.04
Voltage Withstanding, @ 60 Hz	7500	5000	5000
Corona Extinction Voltage, VRMS min. @ 60 Hz	3000	1900	1500
Maximum Operating Frequency	18 GHz	20 GHz	20 GHz
Attenuation, dB/100 ft. (dB/100 m) @:			
0.5 GHz	4.2 (13.8)	7.8 (25.6)	15.4 (50.5)
2.0 GHz	10.0 (32.8)	16.8 (55.1)	31.5 (103.3)
6.0 GHz	19.4 (63.7)	31.3 (102.7)	56.6 (185.6)
10.0 GHz	27.6 (90.6)	42.4 (139.1)	75.1 (246.3)
18.0 GHz	41.4 (135.7)	60.9 (200.0)	104.0 (341.1)
20.0 GHz		63.4 (208.1)	112.0 (367.4)

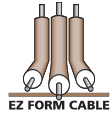

EZFlex Formable™ Cable

High-performance cable that is easy to use

Complicated drawings and expensive bending tooling are a thing of the past with EZFlex Formable™ cable from EZ Form.

The copper-tin composite outer conductor of EZFlex Formable™ Cable provides the same 100% shielding as solid-jacketed semi-rigid, but is easily shaped to your dimensions by hand.

EZFlex Formable™ Cables can be used with solder-on connectors made for semi-rigid cable, providing similar electrical performance without the design and manufacturing headaches.

For RoHS Compliant Cables, please contact factory.

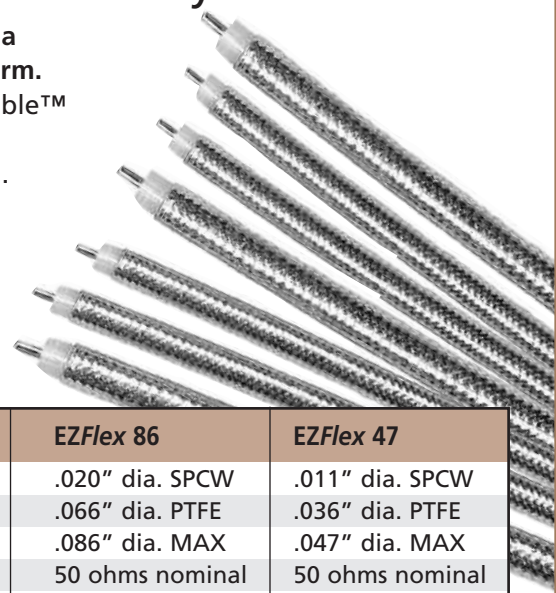

Specifications	EZFlex 250	EZFlex 141	EZFlex 86	EZFlex 47
Inner conductor	.064" dia. SPC	.036" dia. SPCW	.020" dia. SPCW	.011" dia. SPCW
Dielectric	.209" dia. PTFE	.116" dia. PTFE	.066" dia. PTFE	.036" dia. PTFE
Outer Conductor	.250" dia. MAX	.141" dia. MAX	.086" dia. MAX	.047" dia. MAX
Impedance	50 ohms nominal	50 ohms nominal	50 ohms nominal	50 ohms nominal
Velocity	70% nominal	70% nominal	70% nominal	70% nominal
Attenuation @				
500Mhz	5 dB/100 ft	8 dB/100 ft	15 dB/100 ft	28 dB/100 ft
2 Ghz	11 dB/100 ft	21 dB/100 ft	33 dB/100 ft	55 dB/100 ft
10 Ghz	33 dB/100 ft	54 dB/100 ft	82 dB/100 ft	140 dB/100 ft
18 Ghz	48 dB/100 ft	81 dB/100 ft	127 dB/100 ft	190 dB/100 ft
Max. Temp.	90 deg. C	125 deg. C	125 deg. C	100 deg. C
Weight	7.0 lbs/100ft	2.0 lbs/100ft	1.0 lbs/100ft	.5 lbs/100ft
Bend Radius	.375" min.	.25" min.	.25" min.	.25" min.

Ready-made EZFlex Formable™ cable assemblies from EZ Form make your job even easier. You can avoid all the measuring and checking needed to lay out cable assembly shapes for your system—just tell us the total cable length and connectors you need, and install the assemblies when they arrive. See page 13 for part numbers of standard EZFlex Formable™ assemblies.

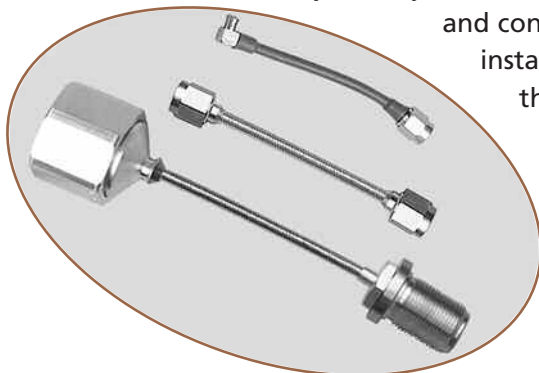

For applications requiring extra abrasion resistance, we can supply assemblies with polyolefin jacketing over the entire cable length.

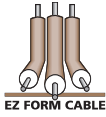

Cable Assemblies

Semi-Rigid • EZFlex™ • EZFlex Formable™

At EZ Form, every aspect of semi-rigid cable assembly fabrication is precisely controlled. The art of precision cable bending and trimming has been perfected over many years to a degree unequalled by any other manufacturer.

Custom tooling is designed to obtain repeatability and optimum fabrication accuracy to meet every requirement. Total quality control (every assembly undergoes 100% mechanical and electrical inspection) ensures reliability and guaranteed performance.

Phase-matched assemblies with tolerances of ± 1 degree per GHz are certified in a fully-equipped electrical testing facility, backed by an engineering staff with years of experience in RF technology. Tighter specifications can be met by utilizing our proprietary techniques.

Flexible cable assemblies are made with the same exacting precision used to fabricate semi-rigid assemblies. The latest in trimming and assembly equipment is used, and 100% inspection yields assemblies with long life under rough and continuous use.

The option of having expert EZ Form craftsmen custom fit assemblies to your chassis is also available, saving you time and the cost of layout and drawings. We offer this unique service to aid OEMs in the fabrication of prototypes and custom-designed chassis.

By allowing EZ Form to manufacture, fit, test, and install the cable assemblies for your chassis, you eliminate costly in-house design, engineering, and drafting time. All you need supply us is your chassis with components installed and a schematic.

Take advantage of our experience, service, and quality, and make your decisions EZ. Call us for a quote.



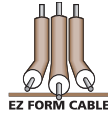

Standard Cable Assemblies

Semi-Rigid Cable • EZFlex Cable™ • EZFlex Formable™ • Flexible Cable

Because all EZ Form cable can be easily shaped by hand, these standard assemblies can save you engineering and assembly time and money.

- No complex drawings needed—just calculate total length needed and shape to fit.
- No scrapping of “extra” assemblies that are pre-bent to a specific configuration.
- You can “tweak” bends to fit your system at time of assembly.
- No costly drawing revisions needed if system changes require different bending.

Connector #1

Cable

Connector #2

← Length →

Part Numbering Example:

NBJ - EZ141ALTP - SMARP - 12

Connector #1

See below for codes

Cable Choice:

semirigid,* EZ Flex,**
EZFlex Formable or flexible

Connector #2

See below for codes

Length

in inches

This example is for an assembly using tin-plated .141" aluminum cable with a type N bulkhead jack on one end and a right angle SMA plug on the other end, 12" long.

*All standard connectors are solder type, so aluminum-jacketed cable must be tin plated.
**EZ Flex is flexible cable, but fits standard connectors for semi-rigid cable.

Standard connectors

Type N Plug (NP)	Type N Jack (NJ)	N Bulkhead Jack (NBJ)	
SMA Plug (SMAP)	SMA Anti-torque Plug (AT-SMAP)	SMA Angle Plug (SMARP)	SMA Bulkhead Jack (SMABJ)
SMB Plug (SMBP)	SMB Angle Plug (SMBRP)	SMB Bulkhead Jack (SMBBJ)	
TNC Plug (TNCP)	TNC Bulkhead Jack (TNCBJ)		

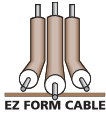

EZArmored Ruggedized Cable Assemblies

The new EZArmored Ruggedized Cable series (EZARM 401 and 402) incorporate our line of high performance EZFlex cables with a nearly indestructible armor jacket.

Designed to withstand the harsh mechanical stresses in the typical laboratory that quickly damage standard test cables, these cables can endure extreme environments where they are subjected to being stepped on by individuals or driven over by vehicles. Test results have shown that they can withstand a compression force of 4000 pounds per linear inch.

- Extremely Rugged
- For Harsh Environments
- Low Leakage
- Low VSWR



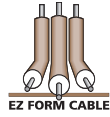

Swept Right Angle Assemblies

An alternative to swept adapters and receptacles

Swept right angle SMA adapters and receptacles provide better electrical performance than standard types, but can be quite expensive and sources are limited. EZ Form swept assemblies offer an economical and dependable alternative, with typical VSWR of 1.25:1 to 18 GHz.

The assemblies incorporate EZ Form .141" cable, and SMA plugs which use the cable center conductor as the contact. Please call for any configurations not shown.

Standard swept assemblies

P/N 300051
SMA Plug-SMA Plug
.141" cable

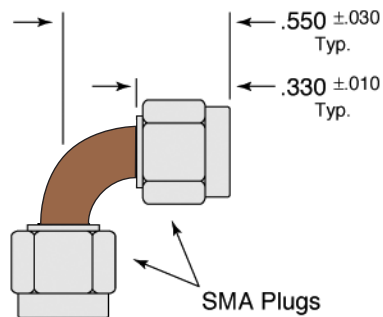

P/N 300053
SMA Plug-Receptacle
.141" cable

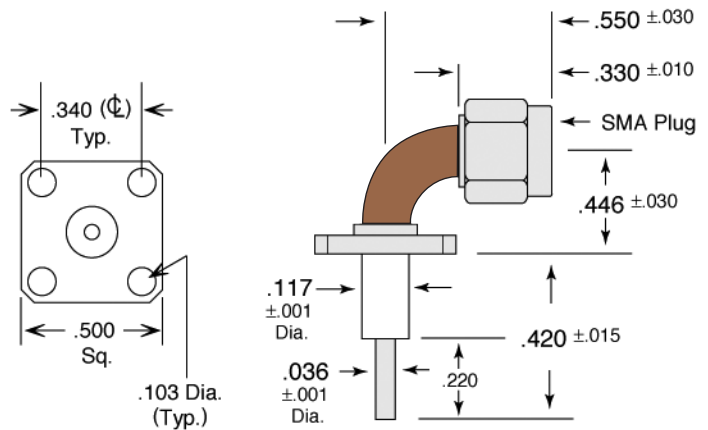

P/N 300052
SMA Plug-SMA JACK
.141" cable

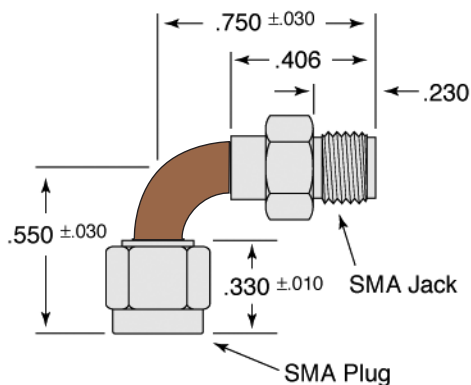

P/N 300054
SMA Jack-Receptacle
.141" cable

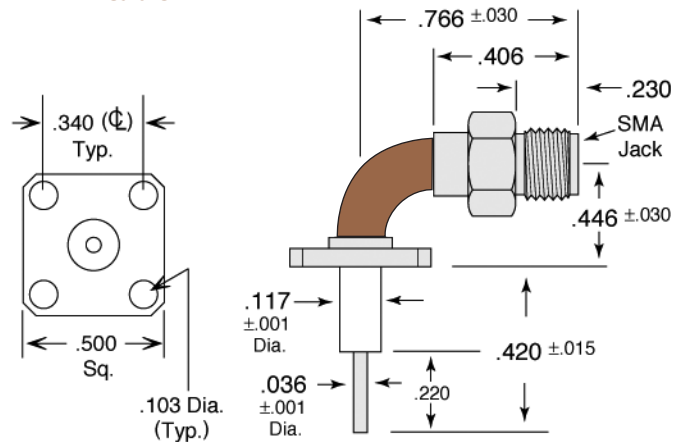

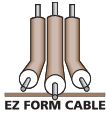

Delay Lines

Custom designed to your requirements

Producing delay lines to exacting customer specifications is a highly-developed capability at EZ Form.

Using our cable with its superior characteristics allows us to shape delay lines into almost any configuration required, and meet your most stringent electrical and mechanical specifications as well.

Our standard delay lines (shown on the next page) fit a wide range of needs, and are available with a short delivery time.

Should you need a special design or a custom electrical specification, our engineers will work with you to configure a delay line that satisfies your requirements.

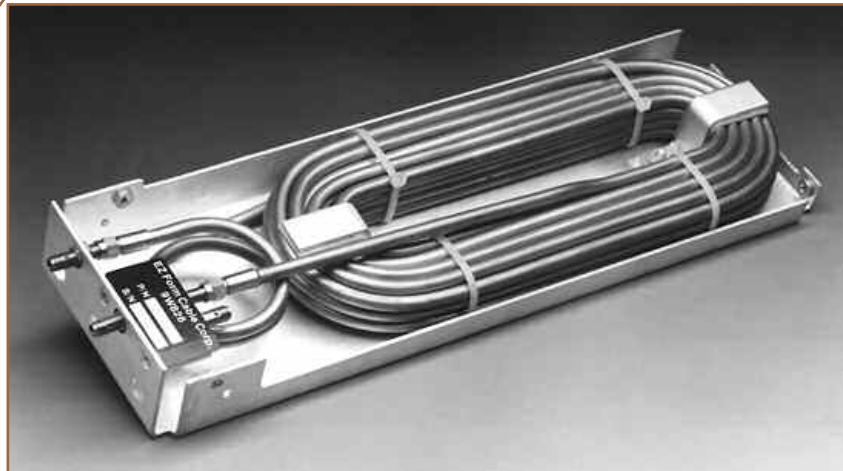

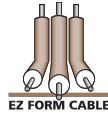

Standard Delay Lines

Copper or aluminum semi-rigid cable

Consistent, reliable standard delay lines from EZ Form are available with short delivery times. Call us with your requirements for custom delay lines with special cable sizes, impedances, finishes, or electrical characteristics.

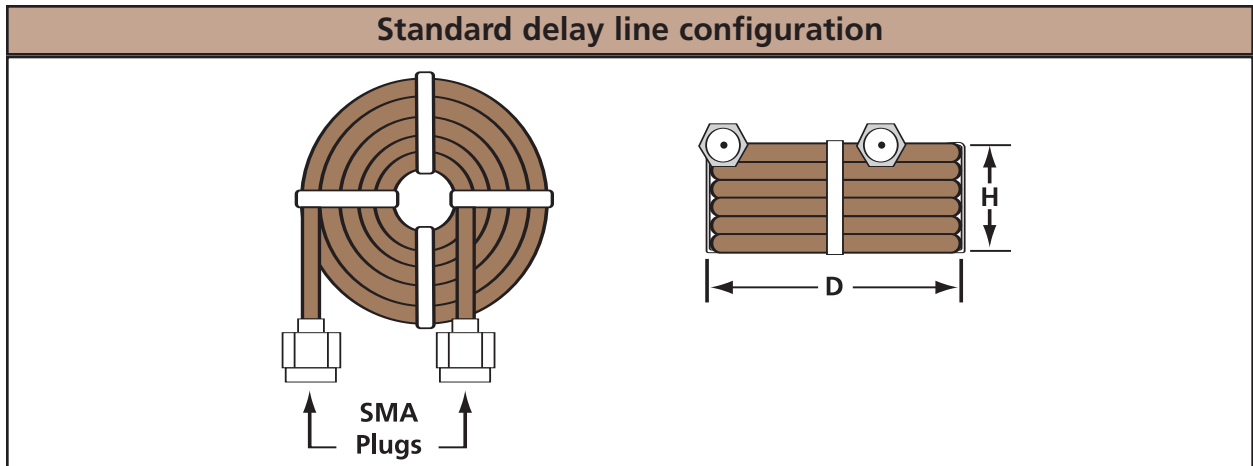

Cable Size	Delay (ns)	Part Number	Max. Dimensions inches (mm)		Max. Weight ounces (g) *See below
			Height	Diameter	
.086	5 ±0.5	EZ86DL5	.19 (4.83)	2.57 (65.3)	3.52 (99.8)
.086	10 ±0.5	EZ86DL10	.38 (9.65)	2.57 (65.3)	4.48 (127)
.086	25 ±0.5	EZ86DL25	1.42 (36.1)	2.38 (60.5)	7.20 (204)
.086	50 ±1.0	EZ86DL50	1.32 (33.5)	2.76 (70.1)	11.70 (331)
.086	100 ±1.0	EZ86DL100	1.70 (43.2)	3.14 (79.8)	19.50 (554)
.141	5 ±0.5	EZ141DL5	.45 (11.4)	2.60 (66.0)	4.80 (136)
.141	10 ±0.5	EZ141DL10	.90 (22.9)	2.60 (66.0)	6.72 (191)
.141	25 ±0.5	EZ141DL25	1.35 (34.3)	2.90 (73.7)	12.80 (363)
.141	50 ±1.0	EZ141DL50	1.95 (49.5)	3.20 (81.3)	23.20 (658)
.141	100 ±1.0	EZ141DL100	3.00 (76.2)	3.50 (88.9)	44.00 (1247)
.250	5 ±0.5	EZ250DL5	1.65 (41.9)	2.55 (64.8)	8.80 (249)
.250	10 ±0.5	EZ250DL10	1.65 (41.9)	3.10 (78.7)	14.40 (408)
.250	25 ±0.5	EZ250DL25	2.20 (55.9)	3.65 (92.7)	32.00 (907)
.250	50 ±1.0	EZ250DL50	3.03 (77.0)	4.20 (107)	61.60 (1746)
.250	100 ±1.0	EZ250DL100	3.58 (90.9)	5.30 (135)	120.00 (3402)

Delay tolerances shown above are standard; delay lines can be made with tolerances as tight as ±20 picoseconds on special order.

*** For 40% weight savings, add "AL" to part number for delay lines made with EZ Form aluminum-jacketed cable.**

As with all EZ Form product lines, we invite your inquiry for delay lines with any specifications or special requirements you may have.

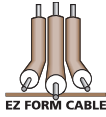

Competitive Cross-Reference

Micro-Coax (Uniform Tube)	EZ Form Cable	Micro-Coax (Uniform Tube)	EZ Form Cable
UT 34	EZ 34/M17	UT-85C-TP-M17	M17/133-00009
UT 34-TP	EZ 34-TP/M17	UT-85-SP-M17	M17/133-00016
UT 34-SP	EZ 34-SP	UT-85-AL-M17	M17/133-00012
UT 34C-10	EZ 34-10	UT-85-AL-TP-M17	M17/133-00013
UT 34C-17	EZ 34-17	UT 141-A	EZ 141/M17
UT 34-25	EZ 34-25	UT 141-A-TP	EZ 141-TP/M17
UT 34-95	EZ 34-95	UT 141-A-SP	EZ 141-SP
UT 34-M17	M17/154-00001	UT 141-AA	Contact Factory
UT 34-TP-M17	M17/154-00002	UT 141C	EZ 141Cu
UT 47	EZ 47/M17	UT 141C-TP	EZ 141Cu-TP
UT 47-TP	EZ 47-TP/M17	UT 141C-SP	EZ 141Cu-SP
UT 47-SP	EZ 47-SP	UT 141C-10	EZ 141-10
UT 47C-35	EZ 47-35	UT 141C-15	EZ 141-15
UT 47-70	EZ 47-70	UT 141C-25	EZ 141-25
UT 47C-LL	EZ 47-LA	UT 141C-35	EZ 141-35
UT 47-M17	M17/151-00001	UT 141-70	EZ 141-70
UT 47-TP-M17	M17/151-00002	UT 141-75	EZ 141-75
UT 47C-AL-TP-LL	EZ 47AL-LA-TP	UT 141C-LL	EZ 141-LA
UT-85	EZ 86/M17	UT 141C-SS	EZ 141Cu-SS
UT-85-TP	EZ 86-TP/M17	UT 141-HA-M17	M17/130-RG-402
UT-85-SP	EZ 86-SP/M17	UT 141-HA-TP-M17	M17/130-00001
UT-85C	EZ 86-Cu/M17	UT 141-SA--M17	M17/130-00004
UT-85C-TP	EZ 86-Cu-TP/M17	UT 141-SA-TP-M17	M17/130-00005
UT-85C-SP	EZ 86-Cu-SP	UT 141-SA-AL-M17	M17/130-00008
UT-85-75-TP	EZ 86-75-TP	UT 141-SA-AL-TP-M17	M17/130-00009
UT-85-H-M17	M17/133-RG-405	UT 250C	EZ 250/M17
UT-85-H-TP-M17	M17/133-00001	UT 250C-TP	EZ 250-TP/M17
UT-85C-H-M17	M17/133-00002	UT 250C-SP	EZ 250-SP
UT-85C-H-TP-M17	M17/133-00003	UT 250-75	EZ 250-75
UT-85-M17	M17/133-00006	UT 250-A-M17	M17/129-RG-401
UT 85-TP-M17	M17/133-00007	UT 250-A-TP-M17	M17/129-00001
UT-85C-M17	M17/133-00008		

Temperature Cycling:

Preconditioning or temperature cycling should not be performed on bulk cable prior to forming, as this will degrade dielectric adherence. When preconditioning is required, it should be performed after all bending is complete and prior to trimming for connector attachment. EZ Form recommends the procedure specified in paragraph 6.6 of MIL-C-17 for preconditioning.

Quality Assurance:

EZ Form's Quality Program meets all requirements of MIL-I-45208.

Warranty:

We warrant our parts to be free of defects in materials and workmanship under normal conditions. If any parts are found to be defective within one year of shipment, we will repair or replace them at our option. This warranty does not apply to parts which have been abused, modified, disassembled, or subjected to conditions exceeding our specifications. We will not under any circumstances be liable for consequential or incidental damages or installation labor. There are no other warranties, express or implied, which extend beyond the description on the face hereof; in particular there is NO WARRANTY OF MERCHANTABILITY OR FITNESS FOR PARTICULAR PURPOSE. No representative is authorized to assume any other liability.

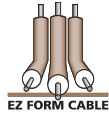

Index by Part Number

Unless otherwise specified, nominal impedance is 50Ω

First set of digits indicates outer conductor diameter in decimal inches (i.e. EZ 38 indicates .038" O.D.).

Part Number	Page	Part Number	Page	Part Number	Page
EZ 34	4	EZ 86-70-TP	(70) *	EZ 141LA	4
EZ 34-SP	*	EZ 86-75	(75) 4	EZ 141-Cu-TP	4
EZ 34-TP	4	EZ 86-75-AL	(75) *	EZ 141-NI...(Nickel plated)	*
EZ 34-17	(17) *	EZ 86-75-AL-TP	(75) *	EZ 141-TP-SJ/M17	4
EZ 34-17-TP	(17) *	EZ 86-75-TP	(75) 4	EZ 141-SJ/M17	*
EZ 34-25	(25) *	EZ 86-93	(93) *	EZ 141-TP	4
EZ 34-25-TP	(25) *	EZ 90-25-AL	(25) *	EZ 141-TP/M17	4
EZ 34-25-SP	(25) *	EZ 90-25-AL-TP	(25) *	EZ 141AA-TP... (50Ω 4.5Ω)	*
EZ 34-95	(95) *	EZ 90-25-Cu	(25) 4	EZ 250AL	6
EZ 34-95-TP	(95) *	EZ 90-25-Cu-TP	(25) 4	EZ 250AL-TP	6
EZ 34-95-SP	(95) *	EZ 118	*	EZ 250-SP	4
EZ 38-25	(25) *	EZ 118-TP	*	EZ 250-TP	4
EZ 38-25-TP	(25) *	EZ 125-25C-SP	(25) *	EZ 250/M17	4
EZ 38-25-SP	(25) *	EZ 141-15-SP	(15) *	EZ 250-TP/M17	4
EZ 43-10	(10) *	EZ 141-25-SP	(25) *	EZ 250-43... (43Ω)	*
EZ 43-10-SP	(10) *	EZ 141-25	(25) *	EZ 250-60... (60Ω)	*
EZ 43-10-TP	(10) *	EZ 141-25-AL	(25) *	EZ 250-75-TP... (75Ω)	*
EZ 47/M17	4	EZ 141-25-TP	(25) *	EZ 325	4
EZ 47-AL	6	EZ 141-35	(35) *	EZ 325-TP	4
EZ 47-AL-TP	6	EZ 141-50-SS-B. (Stainless Steel out. cond.)	*	EZFlex Formable 47, 86, 141, 250	9
EZ 47-Cu	4	EZ 141-70	(70) 4	EZFlex 401, 402, 405	8
EZ 47-Cu-TP	4	EZ 141-70-SP	(70) *	M17/129-RG-401	8
EZ 47-Cu-SP	4	EZ 141-70-TP	(70) 4	M17/129-00001	8
EZ 47-25	(25) *	EZ 141-70-AL	(70) 6	M17/130-RG402	8
EZ 47-75	(75) *	EZ 141-70-AL-SP	(70) *	M17/130-00001	8
EZ 47-TP/M17	4	EZ 141-70-AL-TP	(70) 6	M17/130-00004	8
EZ 50-M	*	EZ 141-75	(75) 4	M17/130-00005	8
EZ 50-M-TP	*	EZ 141-75-AL	(75) *	M17/130-00008	8
EZ 62-18	(18) *	EZ 141-75-AL-TP	(75) *	M17/130-00009	8
EZ 62-18-SP	(18) *	EZ 141-75-SP	(75) 4	M17/130-00012	8
EZ 70-50	*	EZ 141-75-TP	(75) 4	M17/130-00014	8
EZ 70-TP	*	EZ 141-75-Cu	(75) 4	M17/130-00015	8
EZ 70-Cu-TP	*	EZ 141-86-AL	(86) *	M17/133-RG405	8
EZ 70-10	(10) *	EZ 141-86-AL-TP	(86) *	M17/133-00001	8
EZ 70-10-TP	(10) *	EZ 141-100	(100) *	M17/133-00002	8
EZ 70-25	(25) *	EZ 141-100-AL	(100) 6	M17/133-00003	8
EZ 70-25-TP	(25) *	EZ 141-100-AL-TP	(100) 6	M17/133-00006	8
EZ 86-AL	6	EZ 141-AL	6	M17/133-00007	8
EZ 86-AL-SP	6	EZ 141-25-AL	(25) *	M17/133-00008	8
EZ 86-AL-TP	6	EZ 141-AL-Cu	*	M17/133-00009	8
EZ 86-SP	4	EZ 141-AL-Cu-TP	*	M17/133-00012	8
EZ 86-TP/M17	4	EZ 141-AL-LA	6	M17/133-00013	8
EZ 86/M17	4	EZ 141-AL-LA-TP	6	M17/133-00016	8
EZ 86-Cu/M17	4	EZ 141-AL-SP	*	M17/133-00018	8
EZ 86-Cu-SP	4	EZ 141-AL-TP	6	M17/151-00001	8
EZ 86-Cu-TP	4	EZ 141-BE... (Beryllium Copper ctr. cond.)	*	M17/151-00002	8
EZ 86-70	(70) *	EZ 141-Cu	4	M17/154-00001	8
EZ 86-70-SP	(70) *	EZ 141-Cu-SP	4	M17/154-00002	8

*Contact factory for specifications. These cables are not described in this catalog, however they are listed here in order to indicate that they have been produced in the past and are available.