

PART No. DK30LG

for more information visit

www.hammfg.com

Data subject to change without notice

Isometric drawing Not to Scale

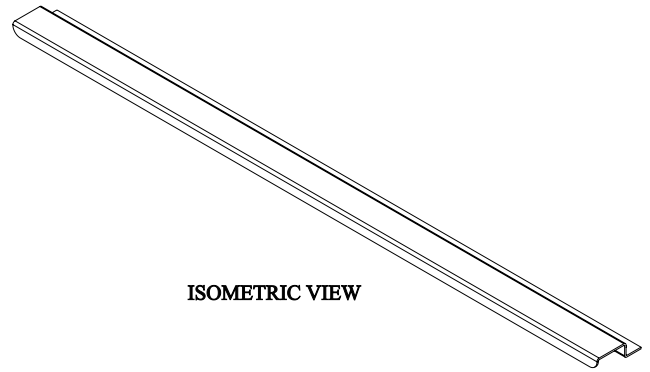

ISOMETRIC VIEW

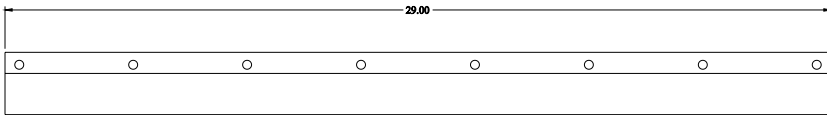

TOP VIEW

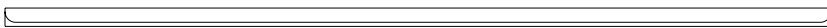

FRONT VIEW



SIDE VIEW