

European Power-Semiconductor and Electronics Company GmbH + Co. KG

# Leistungsgleichrichterdioden Power Rectifier Diodes D 4457 N

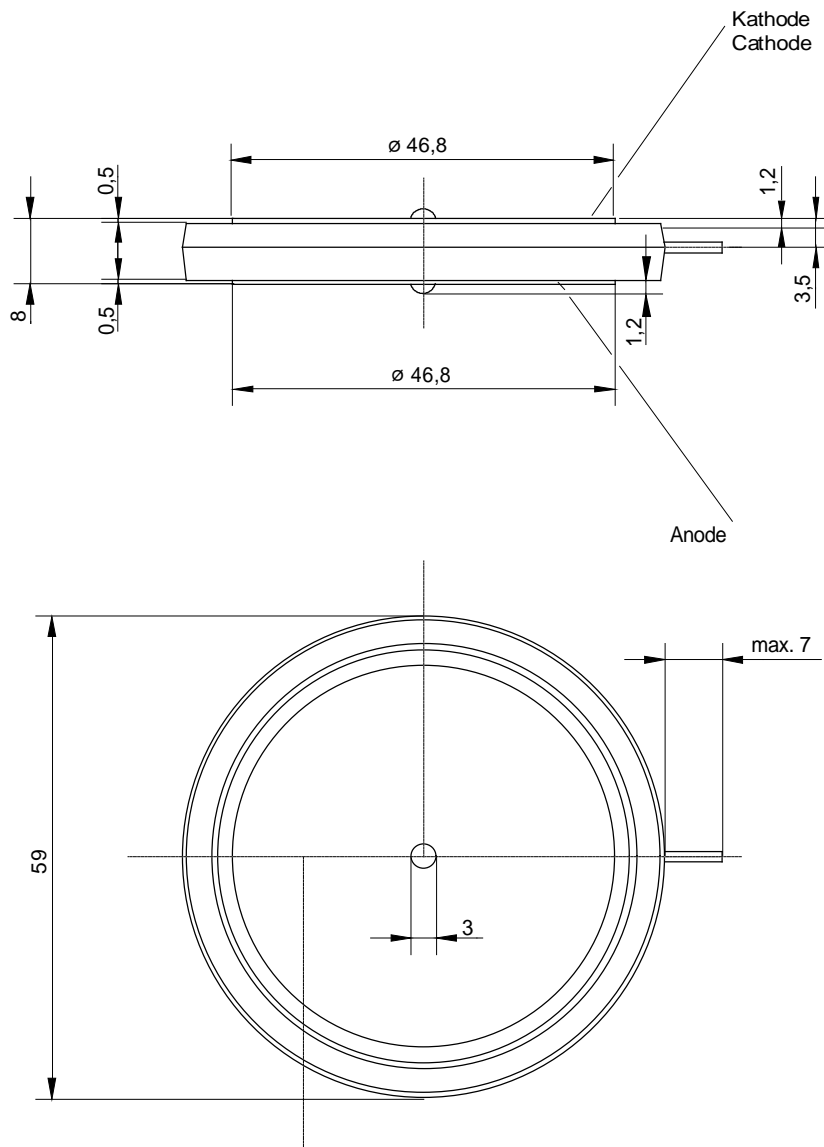

## D 4457 N

### Elektrische Eigenschaften

### Electrical properties

#### Höchstzulässige Werte

#### Maximum rated values

Periodische Spitzensperrspannung	repetitive peak reverse voltage	$t_{vj} = -40^{\circ}\text{C} \dots t_{vj \text{ max}}$	$V_{RRM}$	200, 400	V
				600	V
Stoßspitzensperrspannung	non-repetitive peak reverse voltage	$t_{vj} = +25^{\circ}\text{C} \dots t_{vj \text{ max}}$	$V_{RSM} = V_{RRM}$	+ 50	V
Durchlaßstrom-Grenzeffektivwert	RMS forward current		$I_{FRMSM}$	7	kA
Dauergrenzstrom	mean forward current	$t_c = 111^{\circ}\text{C}$	$I_{FAVM}$	4,46	kA
		$t_c = 130^{\circ}\text{C}$		3,52	kA
Stoßstrom-Grenzwert	surge forward current	$t_{vj} = 25^{\circ}\text{C}, t_p = 10 \text{ ms}$	$I_{FSM}$	60	kA
		$t_{vj} = t_{vj \text{ max}}, t_p = 10 \text{ ms}$		52	kA
Grenzlastintegral	$I^2 t$ -value	$t_{vj} = 25^{\circ}\text{C}, t_p = 10 \text{ ms}$	$I^2 t$	18'000.000	A <sup>2</sup> s
		$t_{vj} = t_{vj \text{ max}}, t_p = 10 \text{ ms}$		13'500.000	A <sup>2</sup> s

#### Charakteristische Werte

#### Characteristic values

Durchlaßspannung	on-state voltage	$t_{vj} = t_{vj \text{ max}}, i_F = 14 \text{ kA}$	$V_T$	max.	1,36	V
Schleusenspannung	threshold voltage	$t_{vj} = t_{vj \text{ max}}$	$V_{T(TO)}$		0,7	V
Ersatzwiderstand	slope resistance	$t_{vj} = t_{vj \text{ max}}$	$r_T$		0,047	mΩ
Sperrstrom	reverse current	$t_{vj} = t_{vj \text{ max}}, V_R = V_{RRM}$	$i_R$	max.	60	mA

### Thermische Eigenschaften

### Thermal properties

Innerer Widerstand	thermal resistance, junction to case	beidseitig/two-sided, $\Theta = 180^{\circ} \text{ sin}$	$R_{thJC}$	max.	0,0128	°C/W
		beidseitig/two sided, DC		max.	0,0120	°C/W
		Anode/anode, $\Theta = 180^{\circ} \text{ sin}$		max.	0,0208	°C/W
		Anode/anode, DC		max.	0,0200	°C/W
		Kathode/cathode, $\Theta = 180^{\circ} \text{ sin}$		max.	0,0308	°C/W
		Kathode/cathode, DC		max.	0,0300	°C/W
Übergangs-Wärmewiderstand	thermal resistance, case to heatsink	beidseitig /two-sided	$R_{thCK}$	max.	0,003	°C/W
		einseitig /single-sided		max.	0,006	°C/W
Höchstzul. Sperrschichttemperatur	max. junction temperature		$t_{vj \text{ max}}$		180	°C
Betriebstemperatur	operating temperature		$t_{c \text{ op}}$		-40...+150	°C
Lagertemperatur	storage temperature		$t_{stg}$		-40...+150	°C

### Mechanische Eigenschaften

### Mechanical properties

Si-Element mit Druckkontakt	Si-pellet with pressure contact	$\varnothing = 46 \text{ mm}$				
Anpreßkraft	clamping force	Gehäuseform/case design T	F		30...45	kN
Gewicht	weight		G	typ.	125	g
Kriechstrecke	creepage distance				5,5	mm
Feuchteklasse	humidity classification	DIN 40040				C
Schwingfestigkeit	vibration resistance	$f = 50 \text{ Hz}$			50	m/s <sup>2</sup>
Maßbild	outline					Seite/page

# D 4457 N

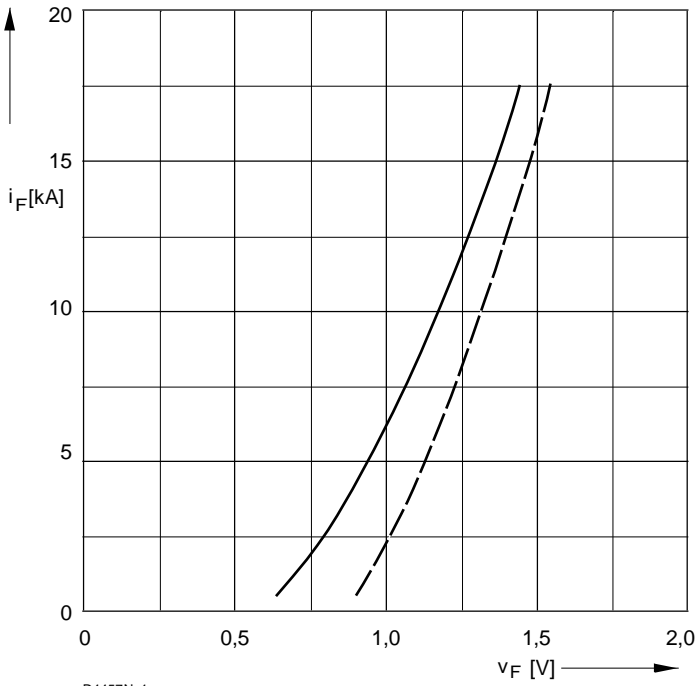

D4457N\_1

Bild/ Fig. 1  
Grenzdurchlaufkennlinie  
Limiting forward characteristic  $i_F = f(v_F)$   
—  $t_{vj} = 180\text{ °C}$   
- - -  $t_{vj} = 25\text{ °C}$

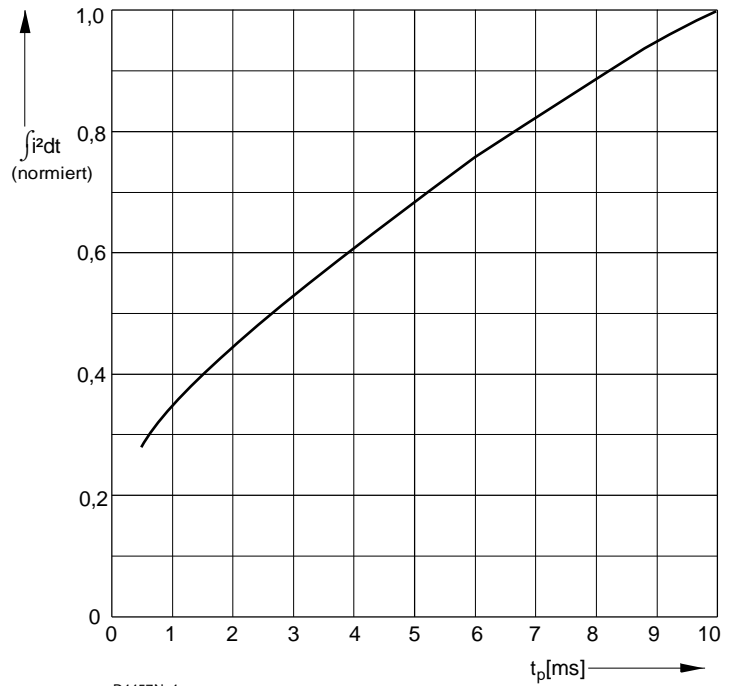

D4457N\_4

Bild / Fig. 2  
Normiertes Grenzlastintegral / Normalized  $i^2t$   
 $\int i^2 dt = f(t_p)$

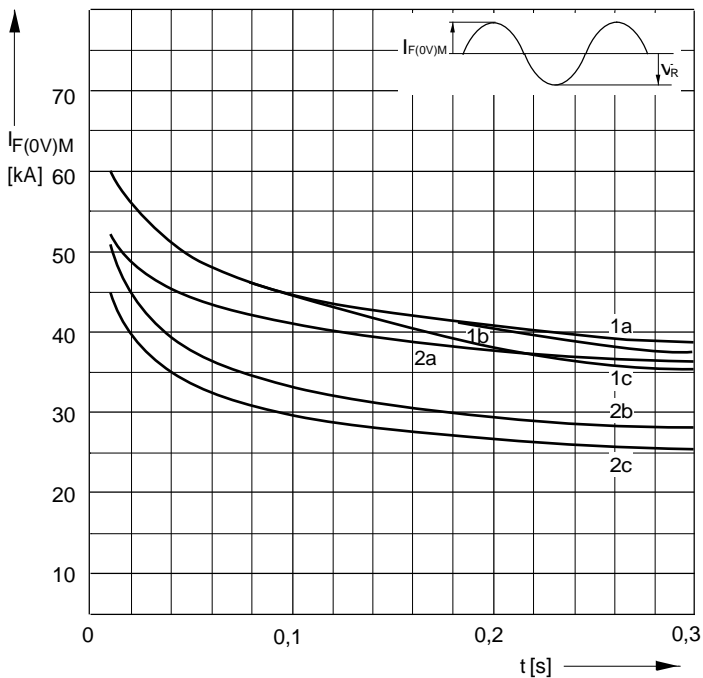

D4457N\_5

Bild / Fig. 3  
Grenzstrom / Maximum overload forward current  $I_{F(0V)M} = f(t)$   
1 -  $I_{FAV(vor)} = 0\text{ A}$ ;  $t_{vj} = t_c = 25\text{ °C}$   
2 -  $I_{FAV(vor)} = 4460\text{ A}$ ;  $t_c = 106\text{ °C}$ ;  $t_{vj} = 180\text{ °C}$   
a -  $v_R \leq 50\text{ V}$   
b -  $v_R = 0,5\text{ }V_{RRM}$   
c -  $v_R = 0,8\text{ }V_{RRM}$

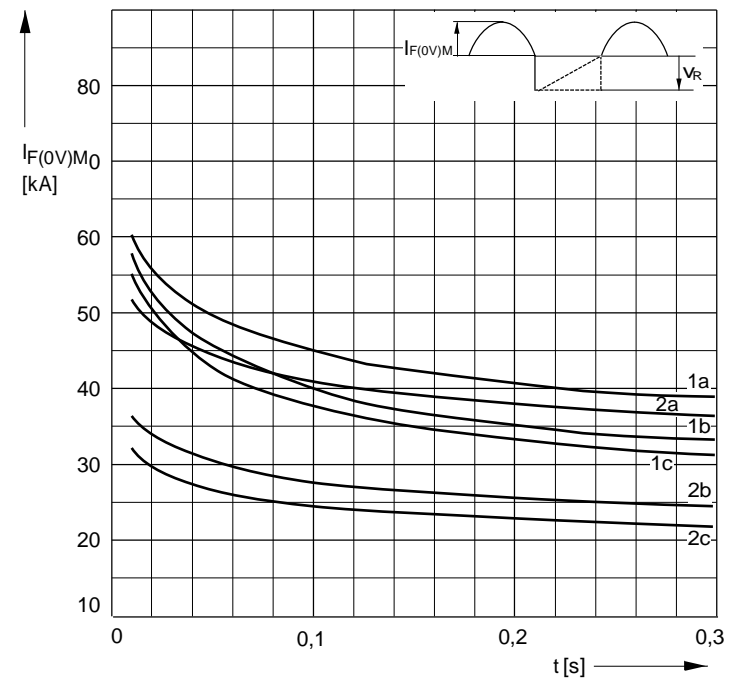

D4457\_6

Bild / Fig. 4  
Grenzstrom / Maximum overload forward current  $I_{F(0V)M} = f(t)$   
1 -  $I_{FAV(vor)} = 0\text{ A}$ ;  $t_{vj} = t_c = 25\text{ °C}$   
2 -  $I_{FAV(vor)} = 4460\text{ A}$ ;  $t_c = 106\text{ °C}$ ;  $t_{vj} = 180\text{ °C}$   
a -  $v_R \leq 50\text{ V}$   
b -  $v_R = 0,5\text{ }V_{RRM}$   
c -  $v_R = 0,8\text{ }V_{RRM}$

# D 4457 N

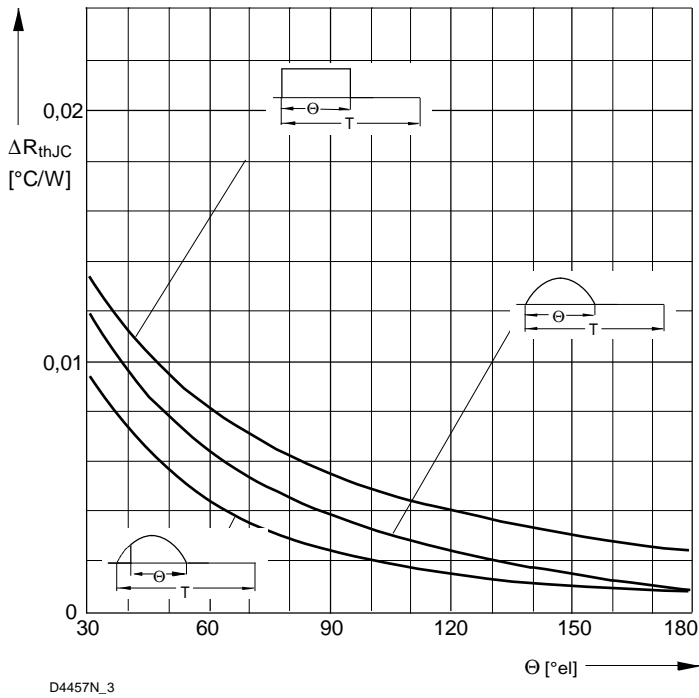

D4457N\_3

Bild / Fig. 5  
 Differenz zwischen den Wärmewiderständen für Pulsstrom und DC  
 Difference between the values of thermal resistance for pulse current and DC  
 Parameter: Stromkurvenform / Current waveform

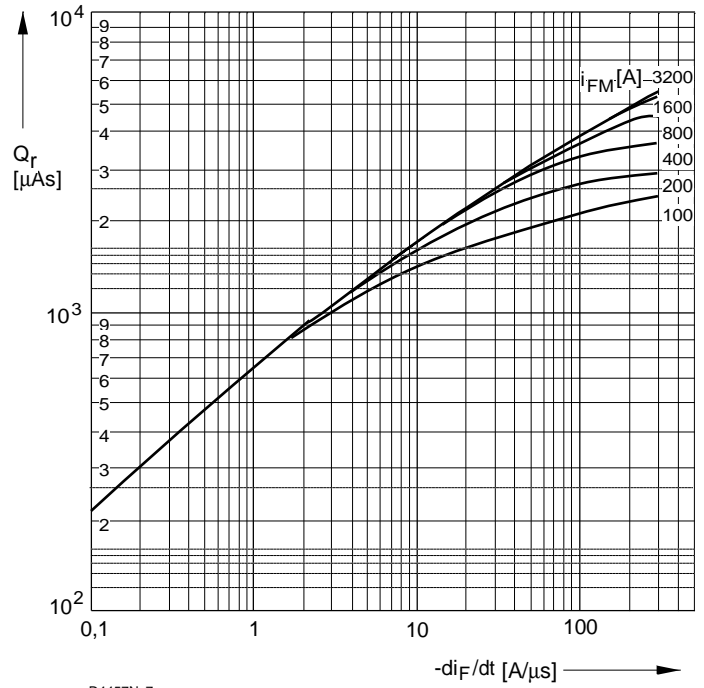

D4457N\_7

Bild / Fig. 6  
 Sperrverzögerungsladung / Recovered charge  $Q_r = f(-di_F/dt)$   
 $t_{vj} = t_{vjmax}$ ;  $V_R \leq 0,5 V_{RRM}$ ;  $V_{RM} = 0,8 V_{RRM}$   
 Beschaltung / Snubber:  $C = 2,2 \mu F$ ;  $R = 1,8 \Omega$   
 Parameter: Durchlaßstrom / Forward current  $i_{FM}$

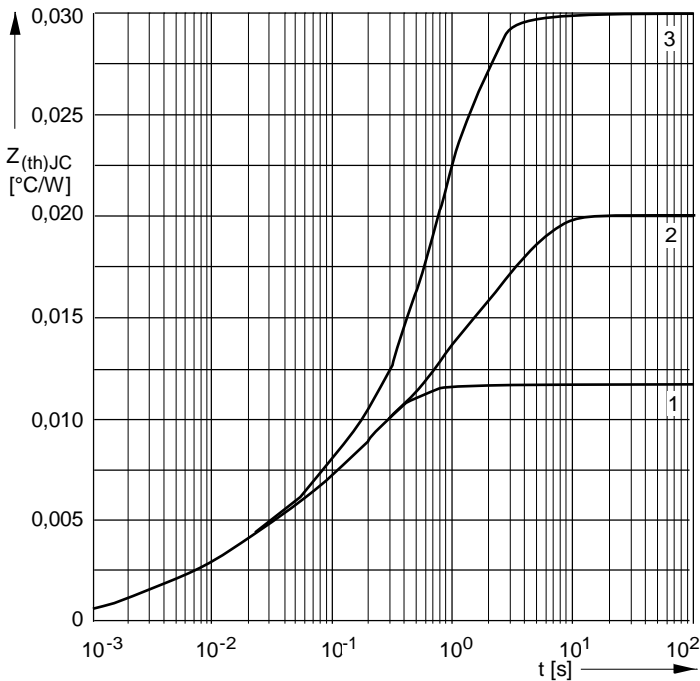

D4457N\_2

Bild / Fig. 7  
 Transienter innerer Wärmewiderstand  
 Transient thermal impedance  $Z_{thjC} = f(t)$ , DC  
 1 - Beidseitige Kühlung / Two-sided cooling  
 2 - Anodenseitige Kühlung / Anode-sided cooling  
 3 - Kathodenseitige Kühlung / Cathode-sided cooling

Analytische Elemente des transienten Wärmewiderstandes  $Z_{thjC}$  für DC  
 Analytical elements of transient thermal impedance  $Z_{thjC}$  for DC

Kühlg. Cooling	Pos. n	1	2	3	4	5	6	7
1	$R_{thn} \text{ } ^\circ\text{C/W}$	0,000017	0,00015	0,00105	0,000563	0,00163	0,00464	0,00405
	$\tau_n \text{ [s]}$	0,000014	0,000173	0,0011	0,00436	0,0195	0,124	0,332
2	$R_{thn} \text{ } ^\circ\text{C/W}$	0,000014	0,000176	0,00115	0,0011	0,0037	0,00226	0,0116
	$\tau_n \text{ [s]}$	0,000012	0,000185	0,0012	0,00836	0,0626	0,172	1,59
3	$R_{thn} \text{ } ^\circ\text{C/W}$	0,00001	0,000144	0,001226	0,00133	0,00198	0,00898	0,01633
	$\tau_n \text{ [s]}$	0,000008	0,000144	0,00117	0,0128	0,0486	0,368	1,18

- 1 - Beidseitige Kühlung / Two-sided cooling
- 2 - Anodenseitige Kühlung / Anode-sided cooling
- 3 - Kathodenseitige Kühlung / Cathode-sided cooling

Analytische Funktion / Analytical function

$$Z_{thjC} = \sum_{n=1}^{n_{max}} R_{thn} (1 - \text{EXP}(-t/\tau_n))$$