

- RoHS Compliant ①
- Lead-Free (Qualified up to 260°C Reflow)
- Application Specific MOSFETs
- Ideal for CPU Core DC-DC Converters
- Low Conduction Losses and Switching Losses
- High Cdv/dt Immunity
- Low Profile (<0.7mm)
- Dual Sided Cooling Compatible ①
- Compatible with existing Surface Mount Techniques ①

V_{DSS}	$R_{DS(on)}$ max	Q_g
20V	2.0m Ω @ $V_{GS} = 10V$	46nC
	2.6m Ω @ $V_{GS} = 4.5V$	

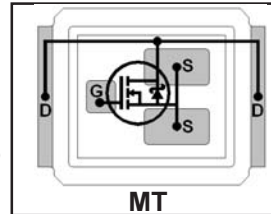

Applicable DirectFET Outline and Substrate Outline (see p.8,9 for details)

SQ	SX	ST		MQ	MX	MT			
----	----	----	--	----	----	-----------	--	--	--

Description

The IRF6609PbF combines the latest HEXFET® Power MOSFET Silicon technology with the advanced DirectFET™ packaging to achieve the lowest on-state resistance in a package that has the footprint of an SO-8 and only 0.7 mm profile. The DirectFET package is compatible with existing layout geometries used in power applications, PCB assembly equipment and vapor phase, infra-red or convection soldering techniques, when application note AN-1035 is followed regarding the manufacturing methods and processes. The DirectFET package allows dual sided cooling to maximize thermal transfer in power systems, improving previous best thermal resistance by 80%.

The IRF6609PbF balances both low resistance and low charge along with ultra low package inductance to reduce both conduction and switching losses. The reduced total losses make this product ideal for high efficiency DC-DC converters that power the latest generation of processors operating at higher frequencies. The IRF6609PbF has been optimized for parameters that are critical in synchronous buck operating from 12 volt bus converters including $R_{ds(on)}$, gate charge and Cdv/dt-induced turn on immunity. The IRF6609PbF offers particularly low $R_{ds(on)}$ and high Cdv/dt immunity for synchronous FET applications.

Absolute Maximum Ratings

	Parameter	Max.	Units
V_{DS}	Drain-to-Source Voltage	20	V
V_{GS}	Gate-to-Source Voltage	±20	
$I_D @ T_C = 25^\circ C$	Continuous Drain Current, $V_{GS} @ 10V$ ⑨	150	A
$I_D @ T_A = 25^\circ C$	Continuous Drain Current, $V_{GS} @ 10V$ ⑥	31	
$I_D @ T_A = 70^\circ C$	Continuous Drain Current, $V_{GS} @ 10V$ ⑥	25	
I_{DM}	Pulsed Drain Current ③	250	
$P_D @ T_C = 25^\circ C$	Power Dissipation ⑨	89	W
$P_D @ T_A = 25^\circ C$	Power Dissipation ⑥	1.8	
$P_D @ T_A = 70^\circ C$	Power Dissipation ⑥	2.8	
	Linear Derating Factor	0.022	
T_J	Operating Junction and	-40 to + 150	°C
T_{STG}	Storage Temperature Range		

Thermal Resistance

	Parameter	Typ.	Max.	Units
$R_{\theta JA}$	Junction-to-Ambient ⑥ ⑩	—	45	°C/W
$R_{\theta JA}$	Junction-to-Ambient ⑦ ⑩	12.5	—	
$R_{\theta JA}$	Junction-to-Ambient ⑧ ⑩	20	—	
$R_{\theta JC}$	Junction-to-Case ⑨ ⑩	—	1.4	
$R_{\theta J-PCB}$	Junction-to-PCB Mounted	1.0	—	

Notes ① through ⑩ are on page 10
www.irf.com

IRF6609PbF

International
IR Rectifier

Static @ $T_J = 25^\circ\text{C}$ (unless otherwise specified)

	Parameter	Min.	Typ.	Max.	Units	Conditions
BV_{DSS}	Drain-to-Source Breakdown Voltage	20	—	—	V	$V_{GS} = 0V, I_D = 250\mu\text{A}$
$\Delta BV_{DSS}/\Delta T_J$	Breakdown Voltage Temp. Coefficient	—	15	—	$\text{mV}/^\circ\text{C}$	Reference to $25^\circ\text{C}, I_D = 1\text{mA}$
$R_{DS(on)}$	Static Drain-to-Source On-Resistance	—	1.6	2.0	$\text{m}\Omega$	$V_{GS} = 10V, I_D = 31A$ ⑤
		—	2.0	2.6		$V_{GS} = 4.5V, I_D = 25A$ ⑤
$V_{GS(th)}$	Gate Threshold Voltage	1.55	—	2.45	V	$V_{DS} = V_{GS}, I_D = 250\mu\text{A}$
$\Delta V_{GS(th)}/\Delta T_J$	Gate Threshold Voltage Coefficient	—	-6.1	—	$\text{mV}/^\circ\text{C}$	
I_{DSS}	Drain-to-Source Leakage Current	—	—	1.0	μA	$V_{DS} = 16V, V_{GS} = 0V$
		—	—	150		$V_{DS} = 16V, V_{GS} = 0V, T_J = 150^\circ\text{C}$
I_{GSS}	Gate-to-Source Forward Leakage	—	—	100	nA	$V_{GS} = 20V$
	Gate-to-Source Reverse Leakage	—	—	-100		$V_{GS} = -20V$
g_{fs}	Forward Transconductance	91	—	—	S	$V_{DS} = 10V, I_D = 25A$
Q_g	Total Gate Charge	—	46	69	nC	$V_{DS} = 10V$ $V_{GS} = 4.5V$ $I_D = 17A$ See Fig. 16
Q_{gs1}	Pre-Vth Gate-to-Source Charge	—	15	—		
Q_{gs2}	Post-Vth Gate-to-Source Charge	—	4.7	—		
Q_{gd}	Gate-to-Drain Charge	—	15	—		
Q_{godr}	Gate Charge Overdrive	—	11	—		
Q_{sw}	Switch Charge ($Q_{gs2} + Q_{gd}$)	—	20	—		
Q_{oss}	Output Charge	—	26	—	nC	$V_{DS} = 10V, V_{GS} = 0V$
$t_{d(on)}$	Turn-On Delay Time	—	24	—	ns	$V_{DD} = 16V, V_{GS} = 4.5V$ ⑤ $I_D = 25A$ Clamped Inductive Load
t_r	Rise Time	—	95	—		
$t_{d(off)}$	Turn-Off Delay Time	—	26	—		
t_f	Fall Time	—	9.8	—		
C_{iss}	Input Capacitance	—	6290	—	pF	$V_{GS} = 0V$ $V_{DS} = 10V$ $f = 1.0\text{MHz}$
C_{oss}	Output Capacitance	—	1850	—		
C_{rss}	Reverse Transfer Capacitance	—	860	—		

Avalanche Characteristics

	Parameter	Typ.	Max.	Units
E_{AS} (Thermally limited)	Single Pulse Avalanche Energy ④	—	240	mJ
I_{AR}	Avalanche Current ③	—	—	A
E_{AR}	Repetitive Avalanche Energy ③	—	18b,	mJ

Diode Characteristics

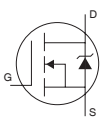
	Parameter	Min.	Typ.	Max.	Units	Conditions
I_S	Continuous Source Current (Body Diode)	—	—	89	A	MOSFET symbol showing the integral reverse p-n junction diode. 
I_{SM}	Pulsed Source Current (Body Diode) ③	—	—	250		
V_{SD}	Diode Forward Voltage	—	0.80	1.2	V	$T_J = 25^\circ\text{C}, I_S = 25A, V_{GS} = 0V$ ⑤
t_{rr}	Reverse Recovery Time	—	32	48	ns	$T_J = 25^\circ\text{C}, I_F = 25A$
Q_{rr}	Reverse Recovery Charge	—	26	39	nC	$di/dt = 100A/\mu\text{s}$ ⑤

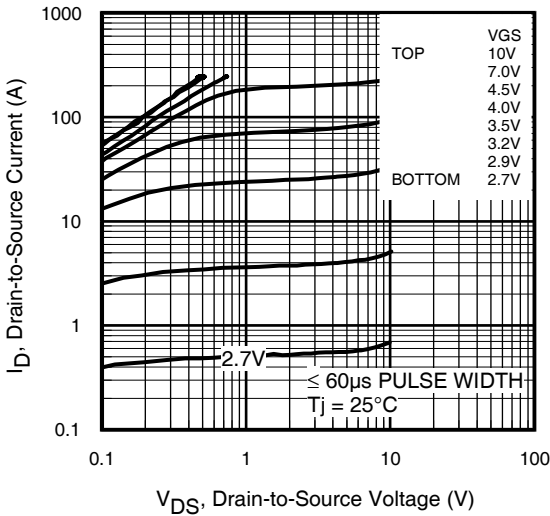

Fig 1. Typical Output Characteristics

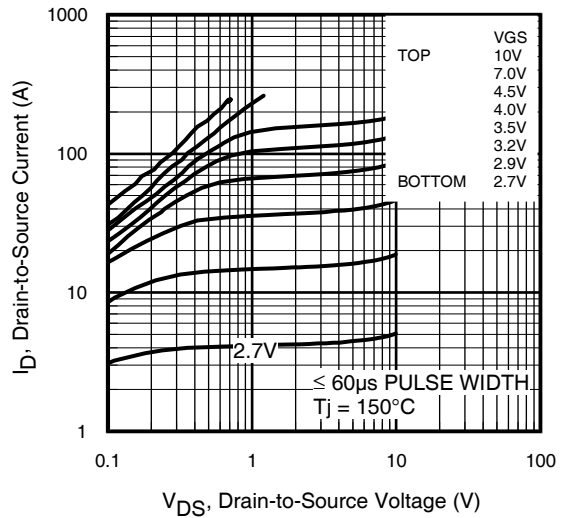

Fig 2. Typical Output Characteristics

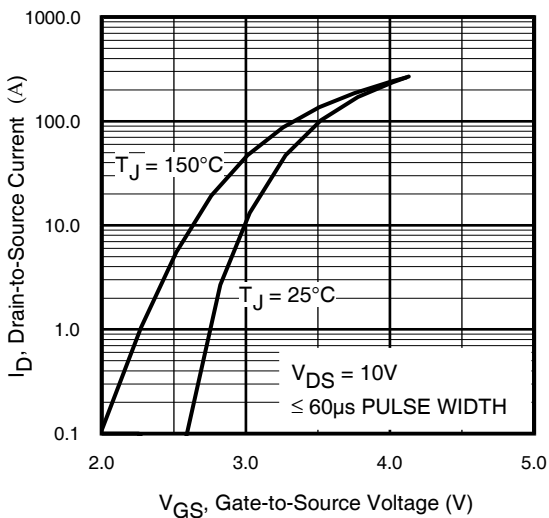

Fig 3. Typical Transfer Characteristics

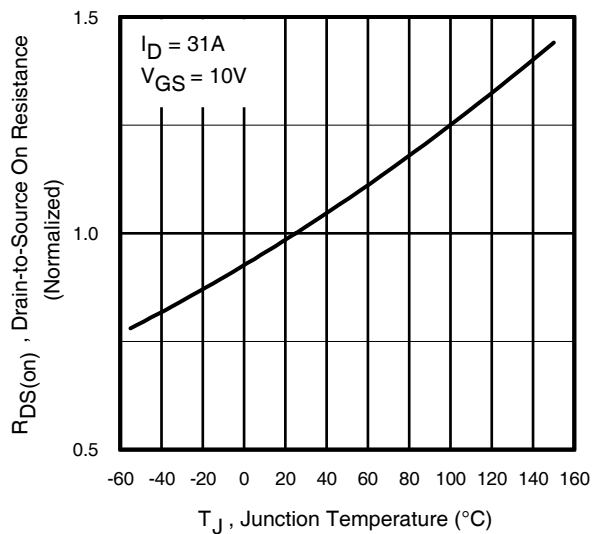

Fig 4. Normalized On-Resistance vs. Temperature

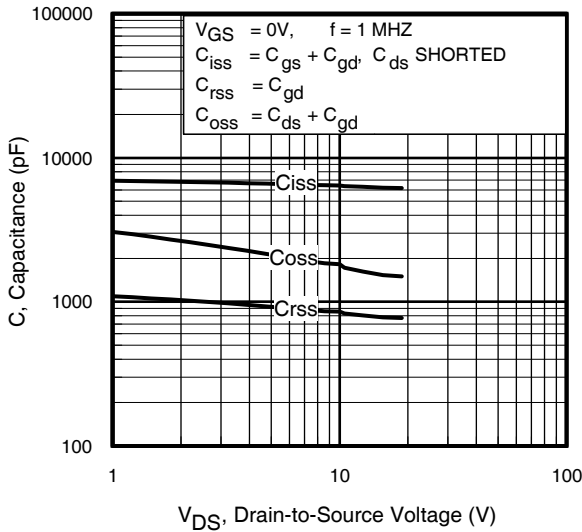

Fig 5. Typical Capacitance vs. Drain-to-Source Voltage

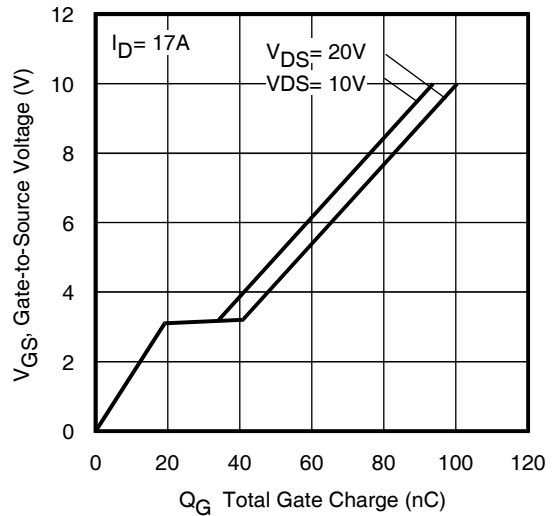

Fig 6. Typical Gate Charge vs. Gate-to-Source Voltage

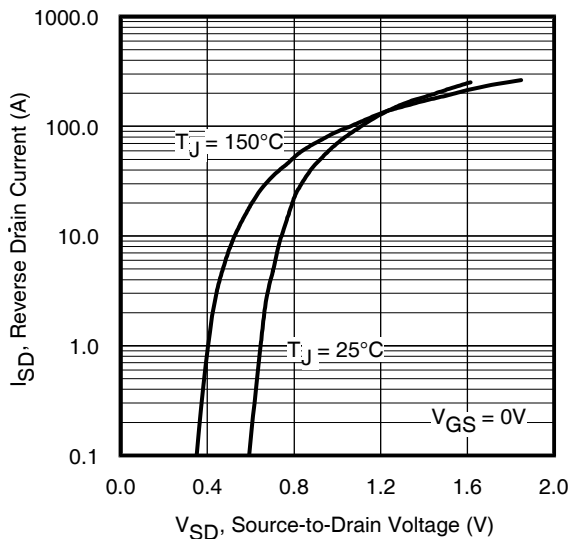

Fig 7. Typical Source-Drain Diode Forward Voltage

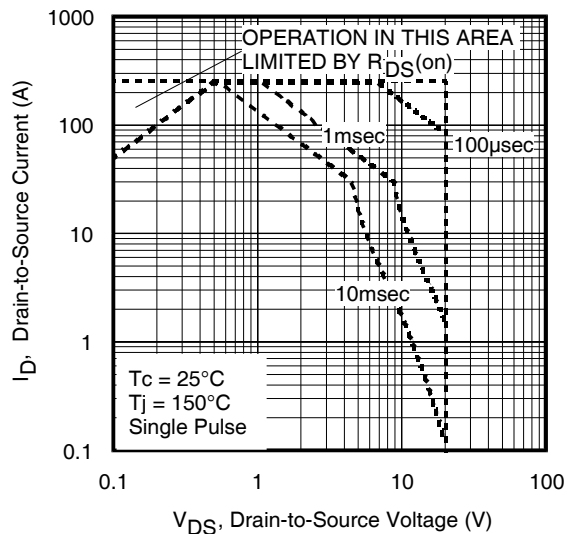

Fig 8. Maximum Safe Operating Area

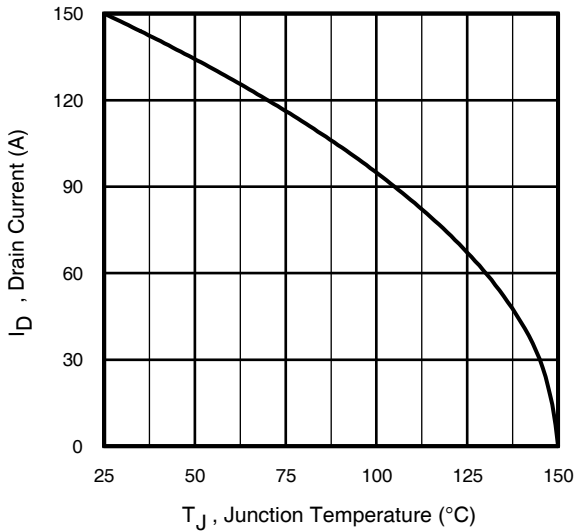

Fig 9. Maximum Drain Current vs. Case Temperature

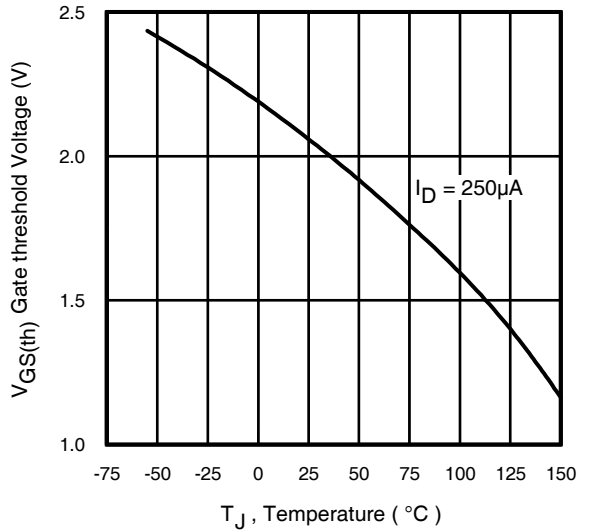

Fig 10. Threshold Voltage vs. Temperature

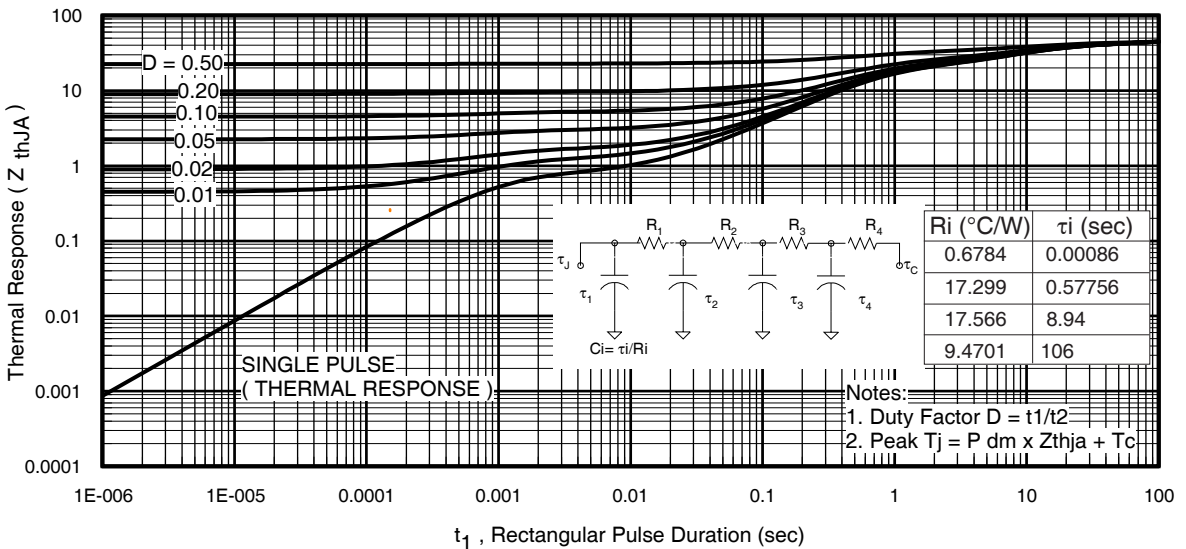

Fig 11. Maximum Effective Transient Thermal Impedance, Junction-to-Ambient

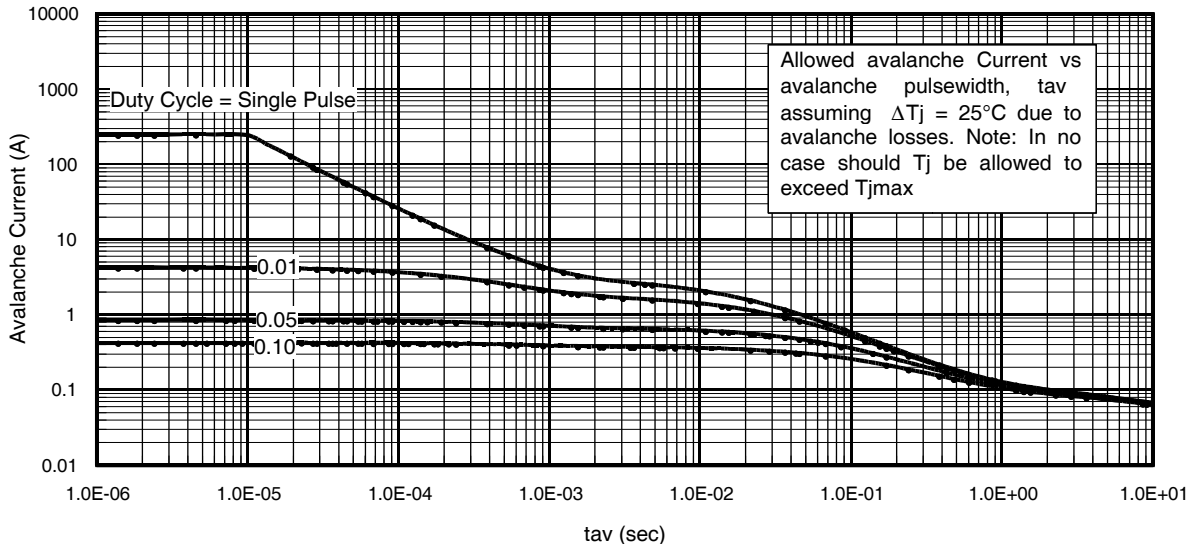

Fig 12. Typical Avalanche Current vs. Pulsewidth

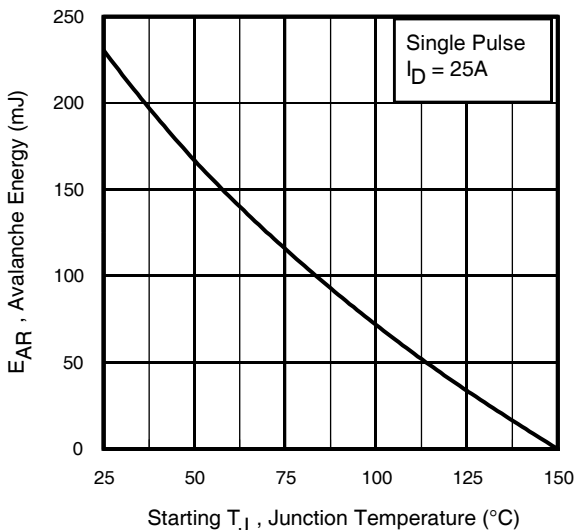

Fig 13. Maximum Avalanche Energy vs. Temperature

**Notes on Repetitive Avalanche Curves , Figures 12, 13:
(For further info, see AN-1005 at www.irf.com)**

1. Avalanche failures assumption:
Purely a thermal phenomenon and failure occurs at a temperature far in excess of T_{jmax} . This is validated for every part type.
2. Safe operation in Avalanche is allowed as long as T_{jmax} is not exceeded.
3. Equation below based on circuit and waveforms shown in Figures 16a, 16b.
4. $P_{D(ave)}$ = Average power dissipation per single avalanche pulse.
5. BV = Rated breakdown voltage (1.3 factor accounts for voltage increase during avalanche).
6. I_{av} = Allowable avalanche current.
7. ΔT = Allowable rise in junction temperature, not to exceed T_{jmax} (assumed as 25°C in Figure 12, 13).
 t_{av} = Average time in avalanche.
 D = Duty cycle in avalanche = $t_{av} \cdot f$
 $Z_{thJC}(D, t_{av})$ = Transient thermal resistance, see figure 11)

$$P_{D(ave)} = 1/2 (1.3 \cdot BV \cdot I_{av}) = \Delta T / Z_{thJC}$$

$$I_{av} = 2\Delta T / [1.3 \cdot BV \cdot Z_{th}]$$

$$E_{AS(AR)} = P_{D(ave)} \cdot t_{av}$$

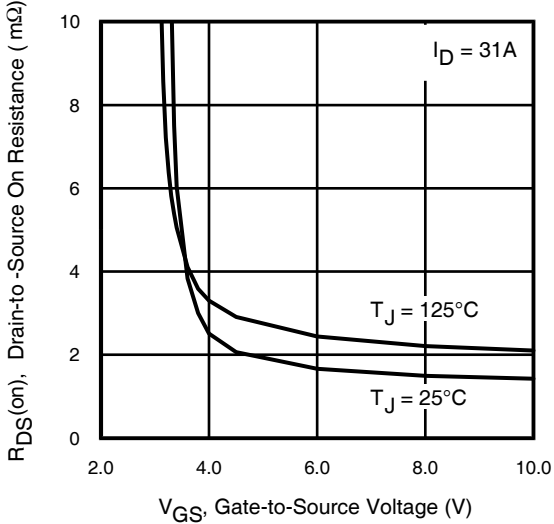

Fig 14. On-Resistance Vs. Gate Voltage

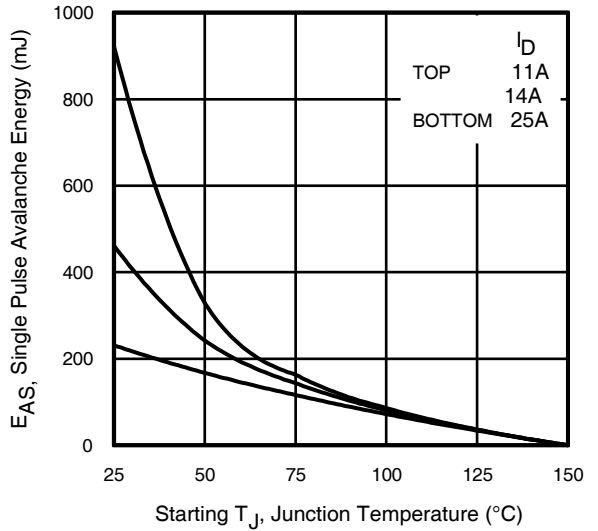

Fig 15. Maximum Avalanche Energy Vs. Drain Current

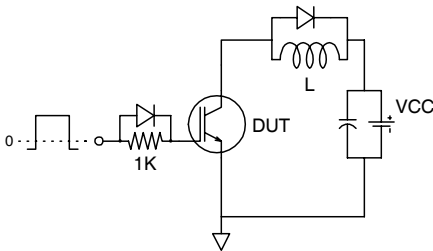

Fig 16a. Gate Charge Test Circuit

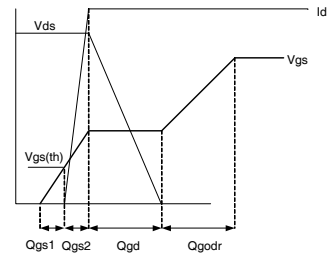

Fig 16b. Gate Charge Waveform

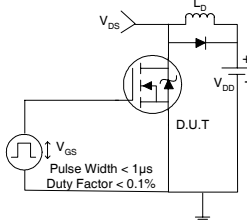

Fig 17a. Switching Time Test Circuit

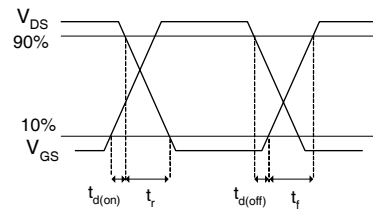

Fig 17b. Switching Time Waveforms

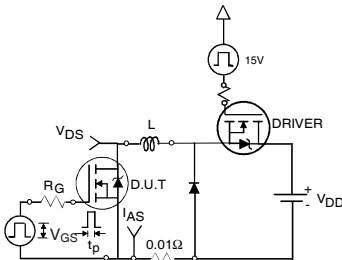

Fig 18a. Unclamped Inductive Test Circuit
www.irf.com

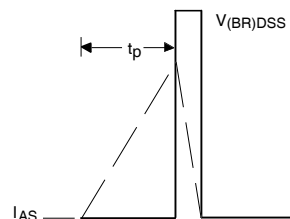

Fig 18b. Unclamped Inductive Waveforms

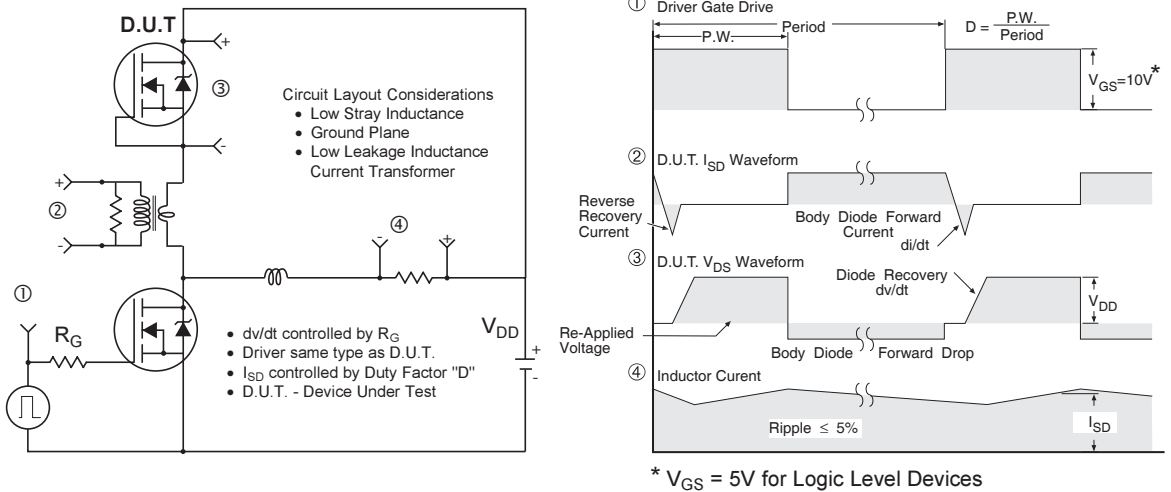
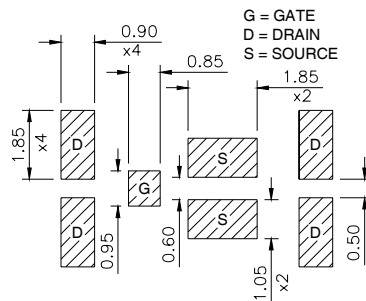
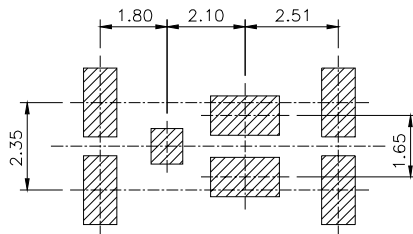

Fig 19. Peak Diode Recovery dv/dt Test Circuit for N-Channel HEXFET[®] Power MOSFETS

DirectFET™ Substrate and PCB Layout, MT Outline (Medium Size Can, T-Designation).

Please see DirectFET application note AN-1035 for all details regarding the assembly of DirectFET. This includes all recommendations for stencil and substrate designs.



DirectFET™ Outline Dimension, MT Outline (Medium Size Can, T-Designation).

Please see DirectFET application note AN-1035 for all details regarding the assembly of DirectFET. This includes all recommendations for stencil and substrate designs.

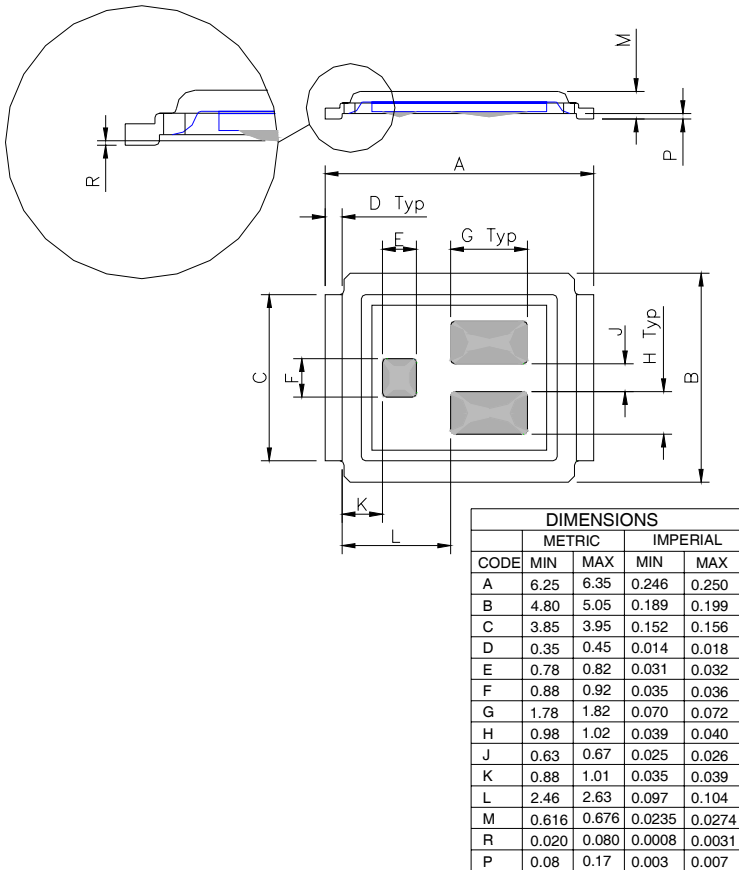

DirectFET™ Part Marking

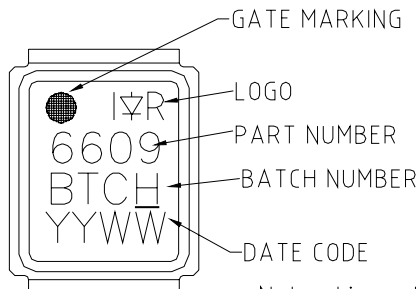

Note: Line above the last character of the date-code indicates "Lead-Free".

IRF6609PbF

DirectFET™ Tape & Reel Dimension (Showing component orientation).

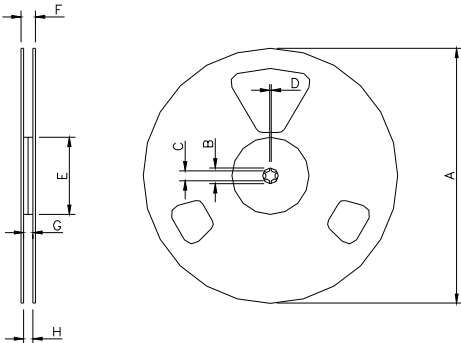

NOTE: Controlling dimensions in mm
Std reel quantity is 4800 parts. (ordered as IRF6609TRPBF). For 1000 parts on 7" reel, order IRF6609TR1PBF

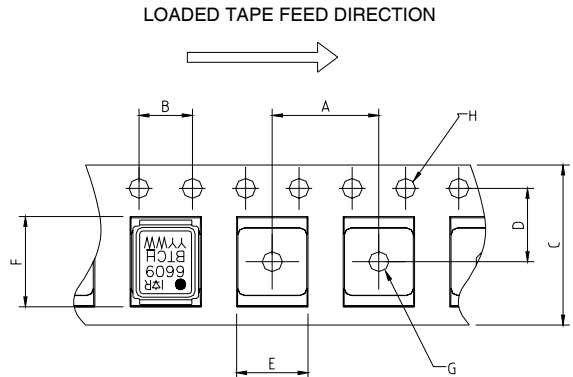

REEL DIMENSIONS								
STANDARD OPTION (QTY 4800)				TR1 OPTION (QTY 1000)				
	METRIC		IMPERIAL		METRIC		IMPERIAL	
CODE	MIN	MAX	MIN	MAX	MIN	MAX	MIN	MAX
A	330.0	N.C	12.992	N.C	177.77	N.C	6.9	N.C
B	20.2	N.C	0.795	N.C	19.06	N.C	0.75	N.C
C	12.8	13.2	0.504	0.520	13.5	12.8	0.53	0.50
D	1.5	N.C	0.059	N.C	1.5	N.C	0.059	N.C
E	100.0	N.C	3.937	N.C	58.72	N.C	2.31	N.C
F	N.C	18.4	N.C	0.724	N.C	13.50	N.C	0.53
G	12.4	14.4	0.488	0.567	11.9	12.01	0.47	N.C
H	11.9	15.4	0.469	0.606	11.9	12.01	0.47	N.C

DIMENSIONS				
	METRIC		IMPERIAL	
CODE	MIN	MAX	MIN	MAX
A	7.90	8.10	0.311	0.319
B	3.90	4.10	0.154	0.161
C	11.90	12.30	0.469	0.484
D	5.45	5.55	0.215	0.219
E	5.10	5.30	0.201	0.209
F	6.50	6.70	0.256	0.264
G	1.50	N.C	0.059	N.C
H	1.50	1.60	0.059	0.063

Notes:

- ① Click on this section to link to the appropriate technical paper.
- ② Click on this section to link to the DirectFET Website.
- ③ Repetitive rating; pulse width limited by max. junction temperature.
- ④ Starting $T_J = 25^\circ\text{C}$, $L = 0.75\text{mH}$, $R_G = 25\Omega$, $I_{AS} = 25\text{A}$.
- ⑤ Pulse width $\leq 400\mu\text{s}$; duty cycle $\leq 2\%$.
- ⑥ Surface mounted on 1 in. square Cu board.
- ⑦ Used double sided cooling, mounting pad.
- ⑧ Mounted on minimum footprint full size board with metalized back and with small clip heatsink.
- ⑨ T_C measured with thermal couple mounted to top (Drain) of part.
- ⑩ R_θ is measured at T_J of approximately 90°C .

Data and specifications subject to change without notice.
This product has been designed and qualified for the Consumer market.
Qualification Standards can be found on IR's Web site.

Note: For the most current drawings please refer to the IR website at:
<http://www.irf.com/package/>