

**PC, DVI & VIDEO INTERFACE CONTROLLER  
FOR TFT PANEL**

**Model: SP-1600**

Part number : 416990030/4X-3

**INSTRUCTIONS**

**CONTENTS**

- Page: **2. Introduction, How to Proceed, Usage Note, Disclaimer**  
**3. System design** – Diagram of a suggested system  
**4. Assembly notes** – Important information about system elements  
**6. Connection & Operation** – How to use the controller  
**10. Connectors, pinouts & jumpers** – Essential connection information  
**19. Controller dimensions**  
**20. Application notes**  
**22. Troubleshooting**  
**23. Specifications**  
**24. Appendix I** – Supported modes table  
**26. Appendix II** – RS-232 control protocols  
**31. Appendix III** – Mapping definition  
**33. Appendix IV** – Auto Color Gain  
**34. Specification for inverter Interface Board P/N 416040010-3**  
**37. Warranty, Caution & Limitation of Liability, Trademarks**  
**38. Contact details**

**It is essential that these instructions are read and understood before connecting or powering up this controller.**

## Introduction

Design for LCD monitor and other flat panel display applications, the SP-1600 controller provides easy to use interface controller for :

- TFT (active matrix) LCD panels of 1600x1200, 1366x768, 1280x1024, 1280x800, 1280x768, 1024x768, 800x600, 800x480 and 640x480 resolutions.
- Computer video signals of VGA, SVGA, XGA, SXGA, WXGA, UXGA standard.
- Video signals of NTSC, PAL and SECAM standard.
- Embedded 3D comb filter on video decoder to display excellent video picture quality.
- DVI input support up to 1600x1200 60Hz input signals

### HOW TO PROCEED

- Ensure you have all parts & that they are correct, refer to:
  - Connection diagram (separate document for each panel)

#### Controller Solution Generator

Full web resource matching controllers & panels with **connection diagrams** for download.  
See at : <http://www.digitalview.com/controllers/csg.php>

- Connector reference (in following section)
- Assembly notes
- Check controller switch & jumper settings (errors may damage the panel)
- Prepare the PC
- Connect the parts
- Understand the operation & functions

### IMPORTANT USAGE NOTE

This equipment is for use by developers and integrators, the manufacturer accepts no liability for damage or injury caused by the use of this product. It is the responsibility of the developer, integrators or other user of this product to:

- Ensure that all necessary and appropriate safety measures are taken.
- Obtain suitable regulatory approvals as may be required.
- **Check power settings to all component parts before connection.**

### DISCLAIMER

There is no implied or expressed warranty regarding this material.

## SYSTEM DESIGN

A typical LCD based display system utilizing this controller is likely to comprise the following:

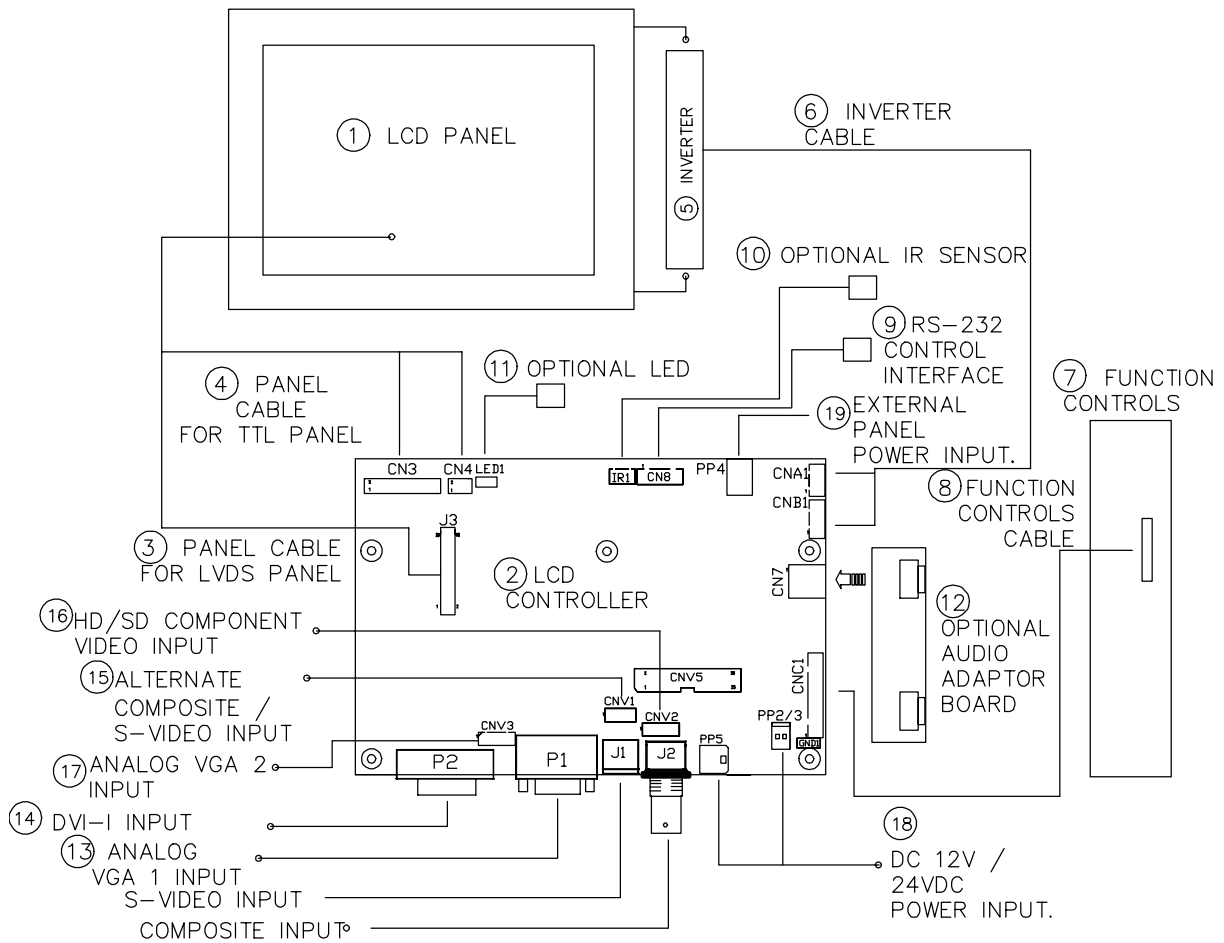

### Summary:

1. LCD panel
2. LCD controller card, SP-1600
3. LCD signal cable (use for LVDS panel)
4. LCD signal cable (use for TTL panel)
5. Inverter for backlight (if not built into LCD)
6. Inverter cable
7. Function controls
8. Function controls cable
9. RS-232 control interface
10. IR sensor (optional)
11. Status LED (optional)
12. Audio add-on board (optional)
13. External type signal inputs
  - Analog VGA 1 input
  - AV input (J1: S-video, J2: Composite video)
14. DVI-I input
15. Alternate composite / S-Video input
16. HD/SD Component video input
17. Analog VGA 2 input
18. 12V/24V DC power input
19. External panel power input

Digital View provides a range of parts, such as listed above, to make up complete display solutions.

## ASSEMBLY NOTES

This controller is designed for monitor and custom display projects using 1600x1200 or 1366x768 or 1280x1024 or 1280x800 or 1280x768 or 1024 x 768 or 800x600 or 800x480 or 640x480 resolution TFT panels with a VGA, SVGA, WXGA, XGA, SXGA or UXGA signal input. The following provides some guidelines for installation and preparation of a finished display solution.

**Preparation:** Before proceeding it is important to familiarize yourself with the parts making up the system and the various connectors, mounting holes and general layout of the controller. As much as possible connectors have been labeled. Guides to connectors and mounting holes are shown in the following relevant sections.

1. **LCD Panel:** This controller is designed for typical LVDS or TTL single interface panels with panel voltage 3.3V, 5V or 12V or 18V. Due to the variation between manufacturers of panels signal timing and other panel characteristics, factory setup and confirmation should be obtained before connecting to a panel. (**NOTE: Check panel power jumper settings before connection**)
2. **Controller:** Handle the controller with care as static charge may damage electronic components. Make sure correct jumper and dip switches settings to match the target LCD panel.
3. **LCD signal cable (Single pixel TTL panel):** In order to provide a clean signal it is recommended that LCD signal cables should not longer than 33cm (13 inches). If loose wire cabling is utilized these can be made into a harness with cable ties. Care should be taken when placing the cables to avoid signal interference. Additionally it may be necessary in some systems to add ferrite cores to the cables to minimize signal noise.
4. **LCD signal cable (LVDS panel):** In order to provide a clean signal it is recommended that LVDS signal cables are no longer than 46cm (18 inches). If those wire cabling is utilized these can be made into a harness with cable ties. Care should be taken when placing the cables to avoid signal interference. Additionally it may be necessary in some systems to add ferrite cores to the cable to minimize signal noise.
5. **Inverter:** This will be required for the backlight of an LCD, some LCD panels have an inverter built in. As LCD panels may have 1 or more backlight tubes and the power requirements for different panel backlights may vary it is important to match the inverter in order to obtain optimum performance. See Application notes page 18 for more information on connection.
6. **Inverter Cables:** Different inverter models require different cables and different pin assignment. Make sure correct cable pin out to match inverter. Using wrong cable pin out may damage the inverter.
7. **Function Controls:** The following section discusses the controls required and the section on connectors provides the detail. The controls are minimal: On/Off, Backlight Brightness (depends on inverter), OSD (5 momentary buttons) analog VR type or (8 momentary buttons) digital type.
8. **Function controls cable:** The cables to the function switches should be of suitable quality and length so that impedance does not affect performance. Generally lengths up to 1 meter (3 feet) should be acceptable.
9. **Status LED:** The pin direction of the LED should be corrected for right colour indication. Red colour stands for standby. Green colour stands for signal on. The status LED is an optional part only, can be unconnected.
10. **IR sensor:** It is an optional part only, can be unconnected if not using IR remote control.
11. **Audio add-on board:** Provide the interface for the audio add-on board to be connected. The audio add-on board gives the audio input and output signal connection. But the volume cannot be controlled by the OSD menu on the controller. It is an optional part only, can be unconnected if not using audio.
12. **VGA Input Cable:** As this may affect regulatory emission test results and the quality of the signal to the controller a suitably shielded cable should be utilized.
  - **AV cables:** Standard Composite or S-video cables can be used. Reasonable quality cable should be used to avoid image quality degradation.
13. **DVI-D input cable :** Plug the DVI cable to the connector P2 on the controller board.
14. **Alternate video input for S-Video and composite video**
15. **HD/SD component video input :** Plug the component video input signal on CNV2 connector
  - **Power Input:** 12V/24VDC is required, this should be a regulated supply. The power rating is depending on the panel and inverter used. Normally, power supply with 3.5Amp current output should enough for most of 4x CCFT panels. Although the controller provides power regulation for the LCD power this does not relate to the power supplied to the backlight inverter. If an unregulated power supply is provided to an inverter any fluctuations in power may affect operation, performance and lifetime of the inverter and or backlight tubes.
  - **Power output:** Note the controller has an overall 3Amp current limit and the current available from the auxiliary power output will be dependent on the power input and other system requirements.
  - **Power Safety:** Note that although only 12VDC / 24VDC is required as 'power-in' a backlight inverter for panel backlighting produces significantly higher voltages (the inverter does not connect to the ground plane). We strongly advise appropriate insulation for all circuitry.

- **EMI:** Shielding will be required for passing certain regulatory emissions tests. Also the choice of external Controller to PC signal cable can affect the result.
- **Ground:** The various PCB mounting holes are connected to the ground plane.
- **Servicing:** The board is not user serviceable or repairable. Warranty does not cover user error in connecting up to the controller and is invalidated by unauthorized modification or repairs.
- **Controller Mounting:** It is recommended that a clearance of at least 10mm is provided above and 5mm below the controller when mounted. Additionally consideration should be given to:
  - Electrical insulation.
  - Grounding.
  - EMI shielding.
  - Cable management. Note: It is important to keep panel signal cables apart from the inverter & backlight cables to prevent signal interference.
  - Heat & Ventilation: Heat generated from other sources, for example the backlight of a very high brightness panel may generate significant heat which could adversely affect the controller.
  - Other issues that may affect safety or performance.
- **PC Graphics Output:** A few guidelines:
  - Signal quality is very important, if there is noise or instability in the PC graphics output this may result in visible noise on the display.
  - Refer to graphics modes table in specifications section for supported modes.
  - Non-interlaced & interlaced video input is acceptable.

**IMPORTANT: Please read the Application Notes section for more information.**

## CONNECTION & OPERATION

**CAUTION:** Never connect or disconnect parts of the display system when the system is powered up as this may cause serious damage.

### CONNECTION

Connection and usage is quite straight forward (it is useful to have the relevant connection diagram available at this time):

1. **LCD panel & Inverter:** Connect the inverter (if it is not built-in the panel) to the CCFT lead connector of the LCD panel.
2. **TTL type (Single pixel) panels:** Plug the signal cables direct to CN3 and CN4 (CN4 will not be used for 3x6-bit panel) on the controller board. Plug the other end of cables to the LCD connector board (if connector board is required, otherwise the signal can be direct plug to the LCD panel connector). Then plug the board connector to the LCD panel connector.  
**LVDS type panels:** The controller board has the built-in LVDS transmitter driver. Plug the LVDS cable to J3. Insert the panel end of the cable the LCD panel connector.
3. **Inverter & Controller:** Plug the inverter cable to CNB1 and CNA1 (if necessary). Plug another end to the connector on the inverter.
4. **Function switch & Controller:** Plug the OSD switch mount cable to CNC1 on the controller board and another to the OSD switch mount.
5. **LED & Controller:** Plug in a 3-way with dual colour LED to connector LED1 on the controller board.
6. **IR & Controller:** Plug in a 3-way with IR sensor to connector IR1 on the controller board.
7. **Jumpers & Switches:** Check all jumpers and switches (JP7, SW3, SW4) are set correctly. Details referring the connection diagram (a separate document) or the jumpers and switches setting table (in the following section).
8. **Jumpers & Inverter & Panel voltage:** Particularly pay attention to the settings of JA3, JA5 & JA6, JB2 and JB3. JB2 & JB3 are used for inverter control (read inverter specification and information on the jumper table to define the correct settings). JA3, JA5 & JA6 are used for panel voltage input (read panel specification and information on the jumper table to define the correct settings).
9. **VGA cable & Controller:** Plug the VGA cable to the connector P1 on the controller board.
10. **Power supply & Controller:** Plug the DC 12V/24V power in to the connector PP5 or PP2/3. You can consider to use DigitalView mating power cable P/N 426013800-3, 160mm for PP5 connection.
11. **External panel power input :** Plug power cable : P/N 426013700-3 for external panel power input (3.3 (max 7A) / 5V (max 7A) / 12V (max 5A) / 18V (max3.5))
12. **Power on:** Switch on the controller board and panel by using the OSD switch mount.

The red LED will light up when power on. The LED will change to green when VGA signal on.

#### General:

- If you are using supplied cables & accessories, ensure they are correct for the model of panel and controller.
- If you are making your own cables & connectors refer carefully to both the panel & inverter specifications and the section in this manual, "Connectors, Pinouts & Jumpers" to ensure the correct pin to pin wiring.

### PC SETTINGS

The controller has been designed to take a very wide range of input signals however to optimize the PC's graphics performance we recommend choosing 60Hz vertical refresh rate – this will not cause screen flicker.

### OPERATION

Once the system has been connected and switched on there are a number of functions available to adjust the display image as summarized in the following sections. The settings chosen will be saved for each mode independently.

### LCD DISPLAY SYSTEM SETTINGS

NOTE: By way of explanation the following refers to a set of sample buttons that may be obtained as an option. In addition to power on/off and connection for backlight brightness the controller provides an On Screen Display of certain functions which are controlled by 5 momentary type buttons (analog VR type) or 8 momentary type buttons (digital type):

Controls	Analog VR type	Digital type
On/Off – turns controller board power on	VR toggle switch	On/Off button
Brightness – controls backlight brightness	Rotary VR	Brightness +/- buttons
Menu – Turns OSD menu On or Off (it will auto time off)	Menu button	Menu button
Select down – Moves the selector to the next function (down)	SEL DN	SEL DN
Select up Moves the selector to the previous function (up)	SEL UP	SEL UP
+ – Increase/Select the OSD parameter values – Go into the sub-menu page – Confirm to select the OSD function	+	+
- – Decrease/Select the OSD parameter values	-	-
Reset to Factory Defaults	Press and hold SEL DN button, then power on the controller	Press and hold SEL DN button, then power on the controller

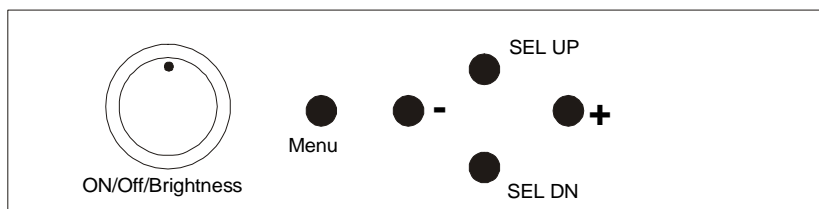

Analog VR type

**12V / 24VDC power input :**  
Analog 10K VR Type OSD switch mount uses P/N 410680550-3 or up

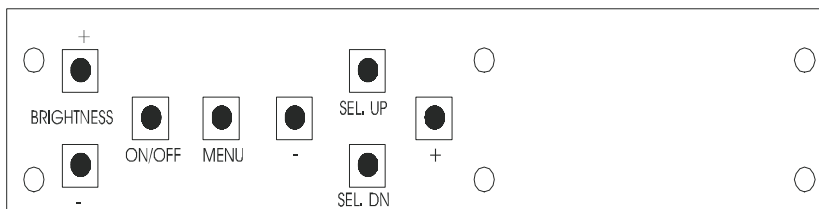

Digital type

**12V / 24VDC power input :**  
Digital 10K Type OSD switch mount uses P/N 416100520-3 or up

**12VDC power input :**  
Digital 10K Type OSD switch mount uses P/N 416100510-3

**OSD functions**



**Picture :**

Volume Increase/decrease volume level, total 31 steps

Brightness Increase/decrease panel brightness level, total: 100 steps

Contrast Increase/decrease panel contrast level, total: 100 steps

Hue \* Increase/decrease Hue level, total: 100 steps

Saturation \* Increase/decrease saturation, total: 100 steps

Sharpness Increase/decrease sharpness, total: 15 steps

**Aspect Size ▶**

Aspect Ratio : Fill Screen / Fill Aspect / 1 to 1 (UNDER ARGB / DVI mode)  
 Auto / Fill Screen / 1 to 1 / Anamorphic (UNDER VIDEO MODE)

- Fill Screen : Enable full screen expansion for lower resolution image
- Fill Aspect : Enable fill screen expansion for lower resolution image according to aspect ratio
- 1 to 1 : Display the exact image resolution on the screen without image expansion.

Horz Position Move the image position horizontally

Vert Position Move the image position vertically

Blue Only : OFF / ON : Turn off the "Red" & "Green" channel (i.e. output all zero to Red & Green channel)

\* : DISPLAY IN VIDEO MODE ONLY



**Main Source :** Select the input video signal

VGA 1 / Composite Video / S-Video / VGA 2 / DVI / HD/SD Component



**Utilities :**

**Setup ▶**

Auto Picture Setup# ▶ : Auto adjust the image position, phase and size

Auto Color Gain# ▶ : Auto Color Calibration (Function in ARGB mode ONLY – See appendix IV)

Manual Clock# : Adjust the image horizontal size

Manual Phase# : Fine tune the data sampling position (adjust image quality)

Auto Source Seek : OFF / ON  
 ON – Auto source select always enable  
 OFF – Disable auto source select function

Auto Power : OFF / ON  
 ON – Enable soft power off function if absence of input signals  
 OFF – Disable soft power function

Video Standard (SD)\*\* : Auto / NTSC / PAL / SECAM / NTSC 443

Gamma : 1.0 / 1.6 / 2.2

**OSD ▶**

H Position : Move the OSD menu image horizontally

V Position : Move the OSD menu image vertically

Timeout (sec) : 1 – 20 : Adjust the OSD menu timeout period in a step of 1 seconds (max 20 seconds)

Language : English / Simplified Chinese : Select OSD menu language display

Transparency : 0 – 100 steps

**Color Temperature ▶**

Color Temp : 9300K / 8000K / 6500K / 5000K

Red :

Green :

Blue :

**Hot Key ▶**

Hot key 1 : Brightness / Contrast / Input / Aspect / Volume

Hot key 2 : Brightness / Contrast / Input / Aspect / Volume



	<p><b>Reset to Factory Defaults</b> ▶</p> <ul style="list-style-type: none"><li>Factory Defaults</li><li>Reset Color Gain<sup>#</sup></li><li>DDC Updates</li></ul> <p style="text-align: right;">** : FUNCTION IN VIDEO MODE ONLY # : DISPLAY AND FUNCTION IN VGA MODE ONLY</p>
--	--

Firmware : V0.15.00 or up

## CONNECTORS, PINOUTS & JUMPERS

The various connectors are:

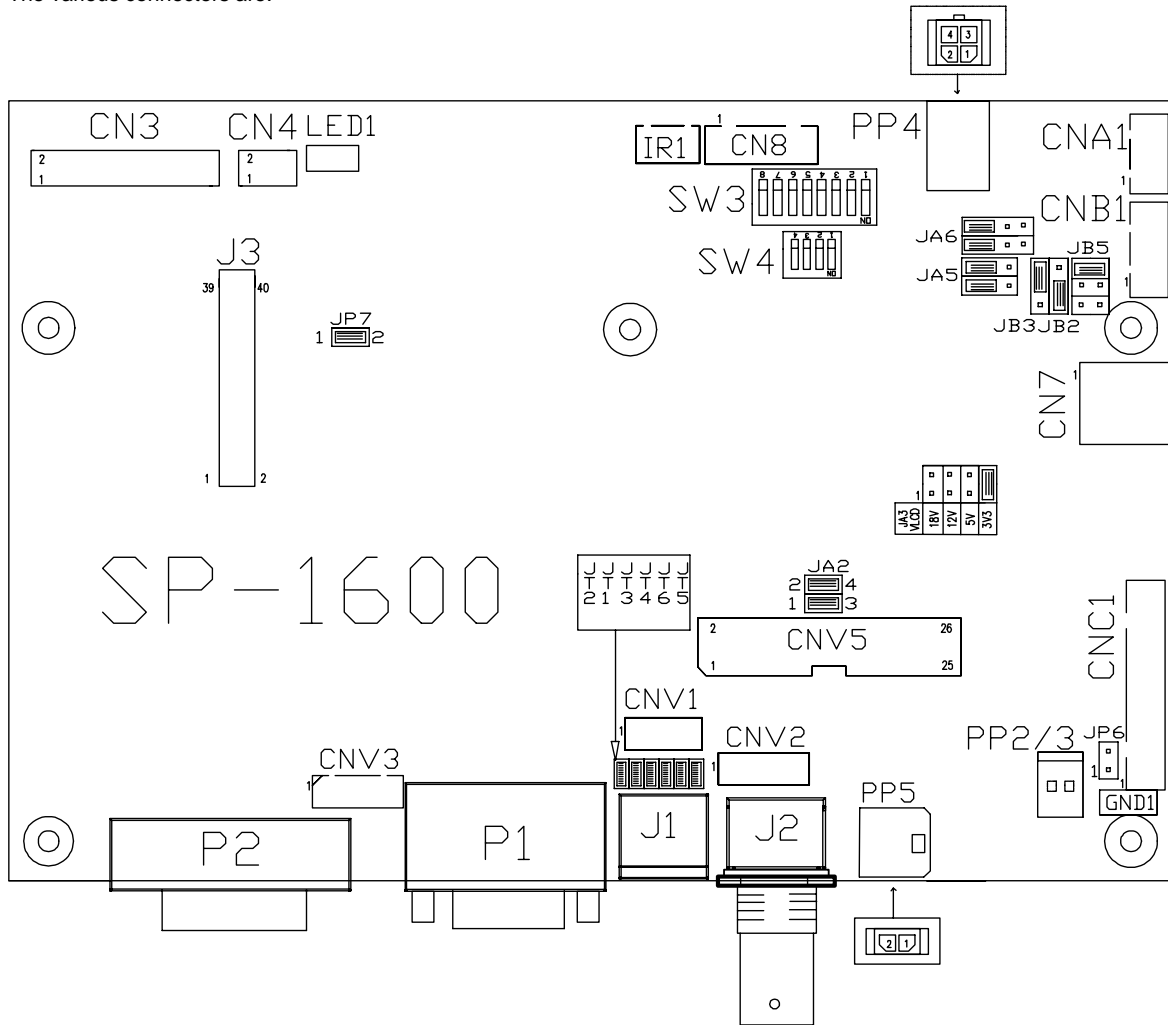

### Summary: Connectors

Ref	Purpose	Description
CN3	Panel signal for TTL panel	Hirose 50-pin, DF20G-50DP-1V (Matching type : DF20A-50DS-1C)
CN4	Panel signal for TTL panel	Hirose 10-pin, DF20G-10DP-1V (Matching type : DF20A-10DS-1C)
CN7	Audio board connector	DIL socket header 5x2 right angle (Matching audio Add-on Board P/N 416940020-3)
CN8	RS-232 serial control	JST 6-way, B6B-XH-A (Matching type : XHP-6)
CNA1	Auxiliary power output	JST 4-way, B4B-XH-A (Matching type : XHP-4)
CNB1	Backlight inverter	JST 5-way, B5B-XH-A (Matching type : XHP-5)
CNC1	OSD controls	JST 12-way, B12B-XH-A (Mating type : XHP-12)
CNV1	Alternate video in	JST 5-way, B5B-PH-K (Matching type : PHR-5)
CNV2	Component video in	JST 6-way, B6B-PH-K (Matching type : PHR-6)
CNV3	ARGB 2 input	12-way pin header (Matching cable : P/N 426003300-3)
CNV5	Reserved	Reserved
J1	S-video in	Mini din 4-way
J2	Composite video in	BNC connector
J3	Panel signal for LVDS panel	Hirose 40 pin, DF13-40DP-1.25DSA (Matching type : DF13-40DS-1.25C)
IR1	Infra-Red sensor connector	JST 3-way, B3B-XH-A (Matching type : XHP-3)
LED1	Dual color LED connector	Header pin 3x1
P1	VGA analog input	DB-15 way high density 3 row
P2	DVI-I input	DVI-I connector
PP2/3	Power input (alternative)	DC power Molex 2 pin 0.156" pitch
PP4	External panel power input	Molex 43045-0400 compatible (Mating type : Molex 43025-0400 or compatible)
PP5	Power input	Molex 43650-0200 compatible (Mating type : Molex 43645-0200 compatible) (Matching power cable : P/N 426013800-3)
SW3	Panel selection	8-way DIP Switch
SW4	Function selection	4-way DIP Switch

**Summary: Jumpers setting**

Ref	Purpose	Note
JA2	On board +3.3V logic power enable	1-3 & 2-4 closed, factory set, do not remove
JA3	Panel power voltage select <b>CAUTION:</b> Incorrect setting can damage panel	See panel voltage setting table 1
JA4	Panel power voltage select <b>CAUTION:</b> Incorrect setting can damage panel	See panel voltage setting table 1
JA5	Panel power voltage select <b>CAUTION:</b> Incorrect setting can damage panel	See panel voltage setting table 1
JB2	Backlight inverter on/off control – signal level	1-2 = On/Off control signal 'High' = +12V/24V 2-3 = On/Off control signal 'High' = +5V Open = On/Off control signal 'High' = Open collector <b>CAUTION:</b> Incorrect setting can damage inverter.
JB3	Backlight inverter on/off control – polarity	1-2 = control signal 'high' = CCFT ON 2-3 = control signal 'low' = CCFT ON
JB5	Backlight control type selection	1-2 = VR/Digital switch mount control 3-4 = RS-232 backlight brightness control 5-6 = Reserved
JP6	Input power control	Short = External switch control Open = Switch mount control
JP7	LVDS or TTL panel selection	Close = LVDS panel OFF = TTL panel
JT1	Composite video-in terminator enable	Open = composite video input is not terminated Close = composite video input is terminated with 75Ω
JT2	S-Video luma-in terminator enable	Open = S-video luma input is not terminated Close = S-video luma input is terminated with 75Ω
JT3	S-Video chroma-in terminator enable	Open = S-video chroma input is not terminated Close = S-video chroma input is terminated with 75Ω
JT4	Component luma-in terminator enable	Open = component luma input is not terminated Close = component luma input is terminated with 75Ω
JT5	Component Cr-in terminator enable	Open = component Cr input is not terminated Close = component Cr input is terminated with 75Ω
JT6	Component Cb-in terminator enable	Open = component Cb input is not terminated Close = component Cb input is terminated with 75Ω
SW3	Panel & function selection	See table below
SW4	Panel & function selection	See table below

**Table 1 : Panel voltage setting table :**

Input voltage via PP2/PP3, PP5	Panel Voltage	JA3	JA5	JA6	Jumper on board
12VDC	3.3V	3V3 closed	1-3 & 2-4	1-3 & 2-4	
	5V	5V closed	1-3 & 2-4	1-3 & 2-4	
	12V	OPEN	1-3 & 2-4	5-7 & 6-8	

**CAUTION: Incorrect setting can damage panel & controller**

Input voltage via PP2/PP3, PP5	Panel Voltage	JA3	JA5	JA6	Jumper on board
24VDC**	3.3V	3V3 closed	1-3 & 2-4	1-3 & 2-4	
	5V	5V closed	1-3 & 2-4	1-3 & 2-4	
	12V	12V closed	1-3 & 2-4	3-5 & 4-6	
	18V	18V closed	1-3 & 2-4	3-5 & 4-6	

**CAUTION: Incorrect setting can damage panel & controller**

**\*\* Ensure that the backlight inverter supports 24V operation prior to connecting a 24VDC input. Because CNA1 pin 1 and CNB1 pin 2 will output 24VDC if input 24VDC via PP2/PP3 or PP5.**

Input voltage via PP4	Panel Voltage	JA3	JA5	JA6	Jumper on board
3.3 / 5 / 12 / 18VDC*	3.3V	OPEN	3-5 & 4-6	1-3 & 2-4	
	5V	OPEN	3-5 & 4-6	1-3 & 2-4	
	12V	OPEN	3-5 & 4-6	3-5 & 4-6	
	18V	OPEN	3-5 & 4-6	3-5 & 4-6	

\* Maximum current for 3.3V, 5V = 7A, Maximum current for 12V = 5A, Maximum current for 18V = 3.5A

JA3, JA5 & JA6 location on board : (Please pay attention to the jumper settings on JA3, JA5 & JA6 which are red in color)

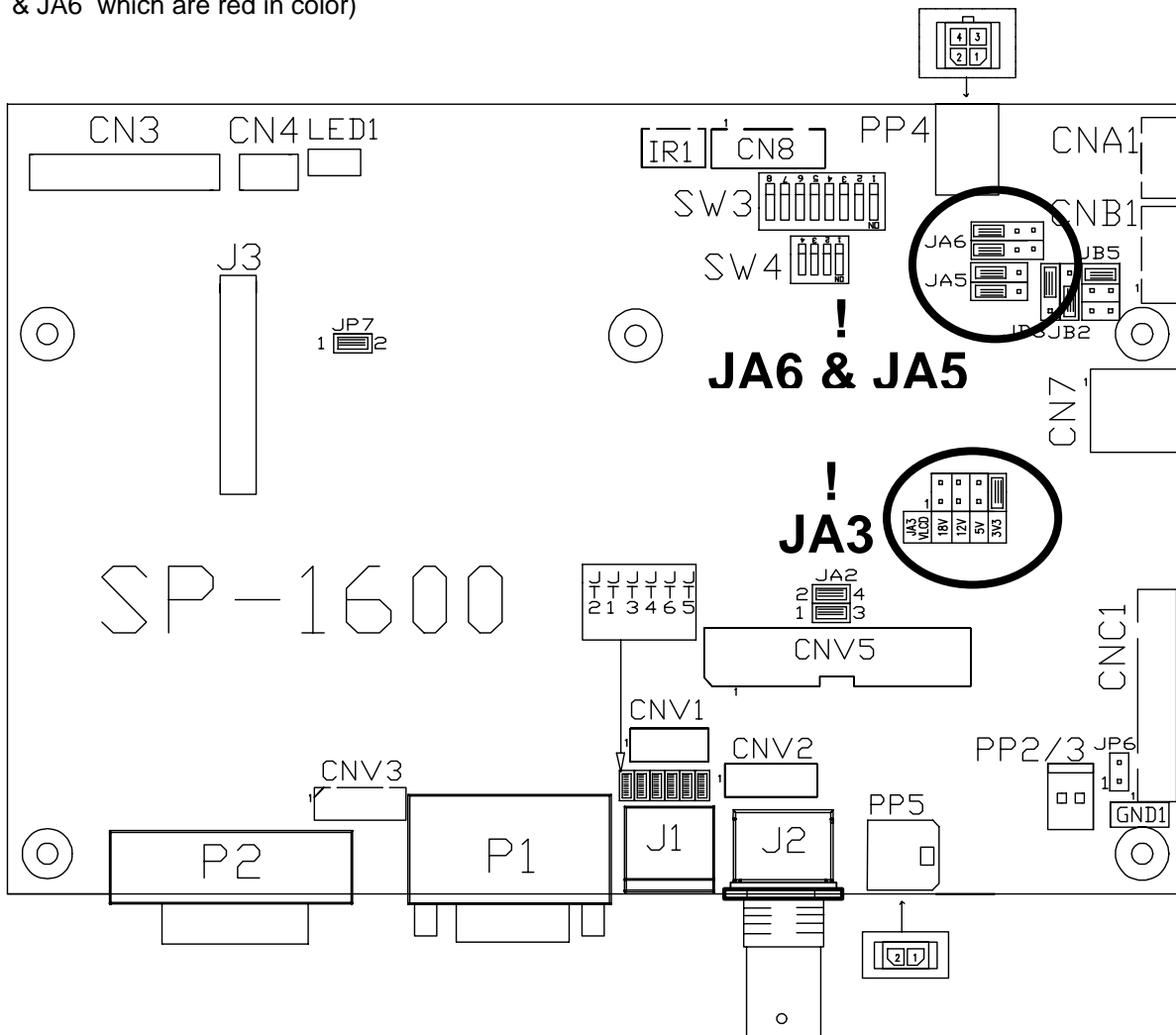

**DIP Switch selection – SW3**

Pos #1	Pos #2	Pos #3	Pos.#4	Description	Panel resolution
<b>For UXGA panels</b>					
ON	OFF	OFF	OFF	NEC NL160120BC27-14	1600x1200
ON	ON	OFF	OFF	Sharp LQ231U1LW01 / Fujitsu FLC59UXC8V-02A <sup>(3)</sup>	1600x1200
<b>For SXGA panels</b>					
OFF	OFF	OFF	OFF	Sharp LQ181E1LW31 Fujitsu FLC48SXC8V	1280x1024 1280x1024
ON	OFF	OFF	OFF	AU Optronics M190EN04	1280x1024
OFF	ON	OFF	OFF	AU Optronics M190EN02 <sup>(1)</sup> / M190EN04 <sup>(1)</sup> – Not tested	1280x1024
<b>For WXGA panels</b>					
OFF	OFF	OFF	OFF	NEC NL12876BC26-21	1280x768
ON	OFF	OFF	OFF	Sharp LQ255T3LZ28 - Not tested	1366x768
OFF	ON	OFF	OFF	LG LC420W02-A4 – Not tested	1366x768
ON	ON	OFF	OFF	Samsung LTA320W2-L01 – Not tested	1366x768
OFF	OFF	ON	OFF	Samsung LTA260W2-L01	1366x768
OFF	ON	ON	ON	Samsung LTM170W1-L01 – Not tested	1280x768
ON	ON	ON	ON	AU Optronics M170XW01 – Not tested	1280x768
ON	OFF	ON	OFF	NEC NL12880BC20-02D <sup>(2)</sup>	1280x800
<b>For XGA panel</b>					
OFF	OFF	OFF	OFF	Sharp LQ150X1LGN2A Sharp LQ150X1LGB1 Samsung LTM150XH-L01 LG LM151X2 AU Optronics M150XN07	1024x768 1024x768 1024x768 1024x768 1024x768
ON	OFF	OFF	OFF	Fujitsu FLC38XGC6V-06	1024x768
OFF	ON	OFF	OFF	LG LM151X2	1024x768
<b>For SVGA panel</b>					
ON	OFF	OFF	OFF	Sharp LQ121S1DG41	800x600
OFF	ON	OFF	OFF	Sharp LQ104S1LG61 <sup>(2)</sup>	800x600
ON	ON	OFF	OFF	Sharp LQ070Y3LG4A <sup>(3)</sup>	800x480
<b>For VGA panel</b>					
ON	OFF	OFF	OFF	Sharp LQ104V1DG21 Sharp LQ104S1DG51	640x480 640x480

(1) - Support on firmware V0.12.00 or up revision.

(2) - Support on firmware V0.15.00 or up revision.

(3) – Support on firmware V0.20.00 or up revision.

For additional and recent added panels, see SP-1600 panel support table at <http://www.digitalview.com/controllers/csg.php>

Pos #5	Pos #6	Pos #7	Description
OFF	OFF	OFF	Reserved
ON	OFF	OFF	UXGA
OFF	ON	OFF	SXGA
ON	ON	OFF	WXGA
OFF	OFF	ON	XGA
ON	OFF	ON	SVGA
OFF	ON	ON	VGA
ON	ON	ON	Others (Reserved)

SW3 Pos 8 = Reserved.

**DIP switch selection – SW4**

Pos. #	Function	Description
1	Clock phase	OFF : Normal ON : Invert
2	Panel pixel format	OFF : Double Pixel ON : Single Pixel
3	Selection of TTL / LVDS panel connection	ON : LVDS OFF : TTL
4	LVDS data mapping select	ON : Mapping A (LVDS panel) OFF : Mapping B (LVDS panel) Please adjust to get the correct picture. See as Appendix II for details of mapping A and B. No function for TTL panels.

**CN3 – Panel connector: HIROSE DF20G-50DP-1V (Matching type : DF20A-50DS-1C)**

PIN	SYMBOL	DESCRIPTION
1	GND	Ground
2	GND	Ground
3	Reserved	Reserved
4	Reserved	Reserved
5	P_R0	Data bit R0
6	P_R1	Data bit R1
7	P_R2	Data bit R2
8	P_R3	Data bit R3
9	P_R4	Data bit R4
10	P_R5	Data bit R5
11	P_R6	Data bit R6
12	P_R7	Data bit R7
13	GND	Ground
14	GND	Ground
15	Reserved	Reserved
16	Reserved	Reserved
17	P_G0	Data bit G0
18	P_G1	Data bit G1
19	P_G2	Data bit G2
20	P_G3	Data bit G3
21	P_G4	Data bit G4
22	P_G5	Data bit G5
23	P_G6	Data bit G6
24	P_G7	Data bit G7
25	GND	Ground
26	GND	Ground
27	Reserved	Reserved
28	Reserved	Reserved
29	P_B0	Data bit B0
30	P_B1	Data bit B1
31	P_B2	Data bit B2
32	P_B3	Data bit B3
33	P_B4	Data bit B4
34	P_B5	Data bit B5
35	P_B6	Data bit B6
36	P_B7	Data bit B7
37	GND	Ground
38	GND	Ground
39	VS	Vertical sync
40	CLK	Dot clock
41	HS	Horizontal sync
42	DE	Display enable
43	PWR	Power down control signal (5v TTL)
44	VLCD	Panel power supply (3.3v/5v configurable)
45	VLCD	Panel power supply (3.3V/5v configurable)
46	VLCD	Panel power supply (3.3V/5v configurable)
47	NC	No connection
48	VLCD12/18	+12V / +18V panel supply (selected by JA3, JA5 & JA6)
49	VLCD12/18	+12V / +18V panel supply (selected by JA3, JA5 & JA6)
50	VLCD12/18	+12V / +18V panel supply (selected by JA3, JA5 & JA6)

**CN4 – Panel connector: HIROSE DF20G-10DP-1V (Matching type : DF20A-10DS-1C)**

PIN	SYMBOL	DESCRIPTION
1	OP1	Reserved
2	OP2	Reserved
3	OP3	Reserved
4	OP4	Reserved
5	IP1	Reserved
6	IP2	Reserved
7	IP3	Reserved
8	IP4	Reserved
9	NC	No connection
10	NC	No connection

**CN7 - Audio connector: DIL socket header 5x2 right angle [OPERATE UNDER 12VDC POWER INPUT ENVIRONMENT]**

PIN	SYMBOL	DESCRIPTION
1	VCC	Audio board logic power supply, +5V
2	VOLSELO	Reserved
3	VOLSEL1	Reversed
4	TUNAUDSEL	Reserved
5	CLK/CNT	Reserved
6	GND	Ground
7	+12V / +24V	Audio board power supply, +12V / +24V
8	NC	No connection
9	NC	No connection
10	GND	Ground

**CN8 – RS-232 serial control: JST B6B-XH-A (Matching type : XHP-6)**

PIN	SYMBOL	DESCRIPTION
1	SDATA	Reserved
2	SCLK	Reserved
3	VCC	+5V
4	TXD	RS-232 Tx data
5	GND	Ground
6	RXD	RS-232 Rx data

**CNA1 - Auxiliary power output: JST B4B-XH-A (Matching type : XHP-4)**

PIN	SYMBOL	DESCRIPTION
1	AUX 12V / 24V	+12V / +24V DC, 500mA max
2	GND	Ground
3	GND	Ground
4	AUX 5V	+5V DC, 500mA max

**CNB1 – Backlight inverter connector: JST B5B-XH-A (Matching type : XHP-5)**

PIN	SYMBOL	DESCRIPTION
1	GND	Ground
2	VBKL	+12V / 24V DC, backlight power supply
3	BLCTRL	On/Off control (enable) – see JB2 & JB3
4	BVR_WIP	Brightness VR – WIP
5	BVR_A	Brightness VR A

**CNC1 – Function controls connector: JST B12B-XH-A (Matching type : XHP-12)**

PIN	SYMBOL	DESCRIPTION
1	PSWIN	Power switch A
2	SW_ON	Power switch B
3	BVR_A	Backlight brightness VR pin A
4	BVR_WIP	Backlight brightness VR pin WIP
5	BVR_B	Backlight brightness VR pin B (470Ω resistor to +5V Vcc)
6	GND	Ground
7	MENU	OSD menu button
8	-/LEFT	OSD -/Left button
9	+ /RIGHT	OSD +/Right button
10	SEL_DN	OSD Select down button
11	SEL_UP	OSD Select up button
12	NC	No connection

The VR for brightness depends on the inverter. The main power load for On/Off is handled by a relay on the controller.

**CNV1 – Alternate Video in input, JST B5B-PH-K (Matching type : PHR-5)**

PIN	DESCRIPTION
1	S-Video : Chroma in
2	S-Video : Luma in
3	Ground
4	Ground
5	Composite video in

**CNV2 – Component Video in input, JST B6B-PH-K (Matching type : PHR-6)**

PIN	DESCRIPTION
1	Luma in /Green in
2	Ground
3	Cb in / Blue in
4	Ground
5	Cr in / Red in
6	Ground



**CNV3 - ARGB 2 input – Double row 2mm pitch pin header**

PIN	SYMBOL	DESCRIPTION
1	R	Red, analog
2	VGA_PWR	+5V power supply for DDC (optional)
3	G	Green, analog
4	GND	Ground
5	B	Blue analog
6	GND	Ground
7	HS	Horizontal sync, input
8	GND	Ground
9	VS_IN	Vertical sync, input
10	DDC_SCL	DDC serial clock
11	NC	No connection
12	DDC_SDA	DDC serial data

**IR1 – Infra-Red sensor connector: JST B3B-XH-A (Matching type : XHP-3)**

PIN	SYMBOL	DESCRIPTION
1	GND	Ground
2	STDBY_Vcc	Stand by voltage
3	IR Data	IR data

**J3 – LVDS Panel connector: Hirose, DF13A-40DP-1.25DSA (Matching type : DF13-40DS-1.25C)**

PIN	SYMBOL	DESCRIPTION
1	TXA0+	Positive differential LVDS data bit A0
2	TXA0-	Negative differential LVDS data bit A0
3	TXA1+	Positive differential LVDS data bit A1
4	TXA1-	Negative differential LVDS data bit A1
5	Reserved	-
6	Reserved	-
7	TXA2+	Positive differential LVDS data bit A2
8	TXA2-	Negative differential LVDS data bit A2
9	TXA3+	Positive differential LVDS data bit A3
10	TXA3-	Negative differential LVDS data bit A3
11	GND	Ground
12	GND	Ground
13	TXAC+	Positive LVDS clock for A channel
14	TXAC-	Negative LVDS clock for A channel
15	GND	Ground
16	GND	Ground
17	TXB0+	Positive differential LVDS data bit B0
18	TXB0-	Negative differential LVDS data bit B0
19	TXB1+	Positive differential LVDS data bit B1
20	TXB1-	Negative differential LVDS data bit B1
21	Reserved	-
22	Reserved	-
23	TXB2+	Positive differential LVDS data bit B2
24	TXB2-	Negative differential LVDS data bit B2
25	TXB3+	Positive differential LVDS data bit B3
26	TXB3-	Negative differential LVDS data bit B3
27	GND	Ground
28	GND	Ground
29	TXBC+	Positive LVDS clock for B channel
30	TXBC-	Negative LVDS clock for B channel
31	GND	Ground
32	GND	Ground
33	VDD (3,3V/5V)	Panel power supply (3,3V/5V)
34	VDD (3,3V/5V)	Panel power supply (3,3V/5V)
35	VDD (3,3V/5V)	Panel power supply (3,3V/5V)
36	VDD (3,3V/5V)	Panel power supply (3,3V/5V)
37	NC	No connection
38	VDD +12V/18	Panel power supply (+12V / +18V)
39	VDD +12V/18	Panel power supply (+12V / +18V)
40	VDD +12V/18	Panel power supply (+12V / +18V)

**LED1 – Status LED connector: 3-pin header**

PIN	DESCRIPTION
1	Green LED pin (anode)
2	LED pin common (cathode)
3	Red LED pin (anode)

**P1 - Analog VGA in - 15 way connector**

PIN	SYMBOL	DESCRIPTION
1	PCR	Red, analog
2	PCG	Green, analog
3	PCB	Blue analog
4	ID2	Reserved for monitor ID bit 2 (grounded)
5	DGND	Digital ground
6	AGND	Analog ground red
7	AGND	Analog ground green
8	AGND	Analog ground blue
9	DDC_5V	+5V power supply for DDC (optional)
10	DGND	Digital ground
11	ID0	Reserved for monitor ID bit 0 (grounded)
12	DDC_SDA	DDC serial data
13	HS_IN	Horizontal sync or composite sync, input
14	VS_IN	Vertical sync, input
15	DDC_SCL	DDC serial clock

**P2 – DVI-I input**

PIN	SYMBOL	DESCRIPTION
1	/RX2	TMDS Data 2-
2	RX2	TMDS Data 2+
3	GND	Digital Ground
4	NC	No connection
5	NC	No connection
6	DDC_CLK	DDC Clock
7	DDC_DAT	DDC Data
8	VS_IN	Analog vertical Sync
9	/RX1	TMDS Data 1-
10	RX1	TMDS Data 1+
11	GND	Digital Ground
12	NC	No connection
13	NC	No connection
14	DDC_5V	+5V power supply for DDC (optional)
15	GND	Ground (+5, Analog H/V Sync)
16	NC	No connection
17	/RX0	TMDS Data 0-
18	RX0	TMDS Data 0+
19	GND	Digital Ground
20	NC	No connection
21	NC	No connection
22	GND	Digital Ground
23	RXC	TMDS Clock+
24	/RXC	TMDS Clock-
C1	R	Red
C2	G	Green
C3	B	Blue
C4	HS_IN	Analog horizontal sync
C5	GND	Ground
C6	NC	No connection

**PP2/PP3 – Alternate 12V / 24V DC power supply - DC power Molex 2 pin 0.156" pitch**

PIN	DESCRIPTION
1	+12V / +24V DC in
2	Ground

**PP4 - External panel power input - Molex 43045-0400 compatible (Mating type : Molex 43025-0400 or compatible)**

PIN	DESCRIPTION
1	External panel power output
2	Ground
3	External panel power output
4	Ground

**PP5 - Molex 43650-0200 compatible (Mating type : Molex 43645-0200 or compatible)**

PIN	DESCRIPTION
1	+12V / +24V DC
2	Ground

## CONTROLLER DIMENSIONS

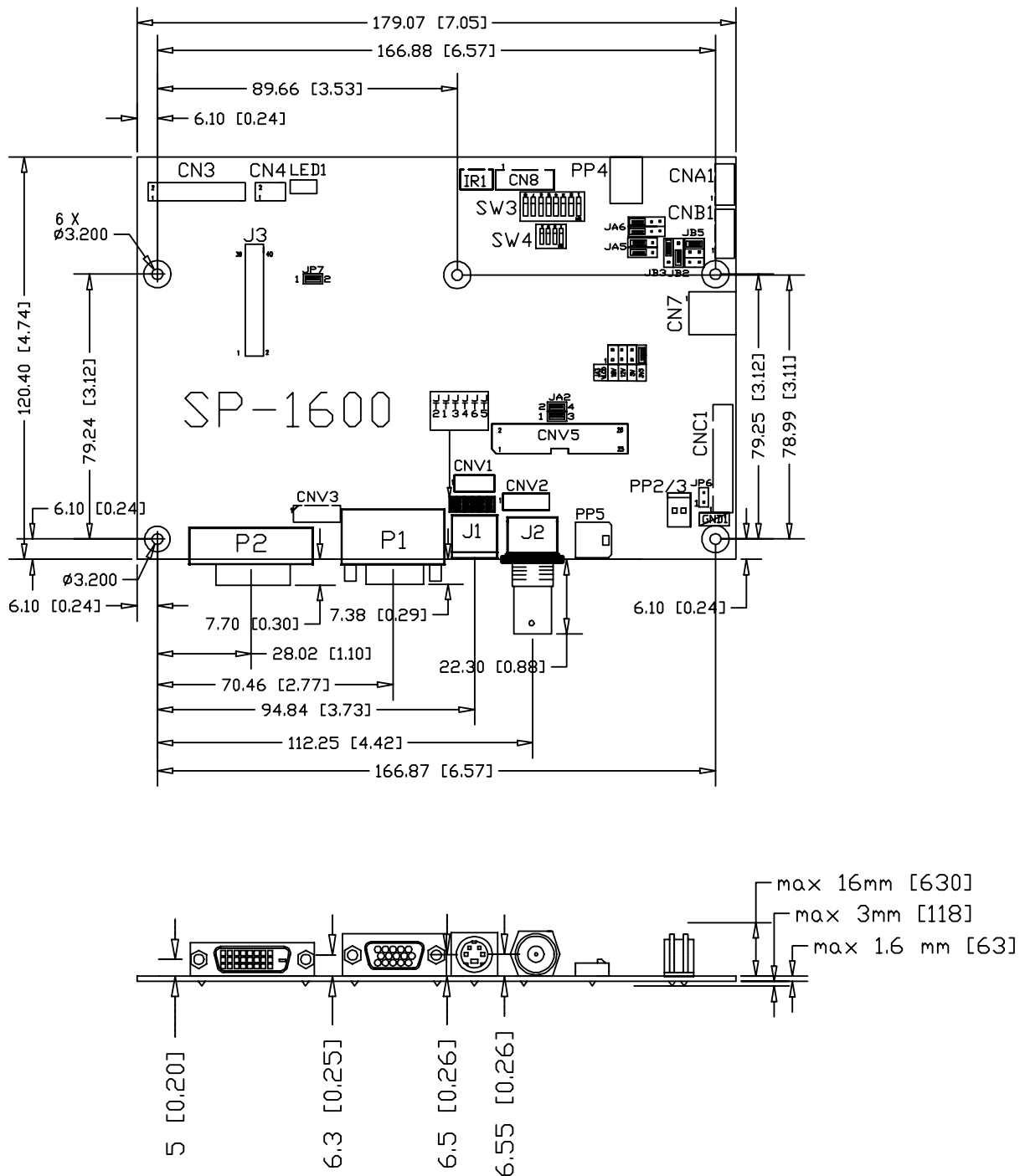

The maximum thickness of the controller is 20.6mm with or without video add-on board (measured from bottom of PCB to top of components, including any underside components & leads). We recommend clearances of:

- 5mm from bottom of PCB - if mounting on a metal plate we also recommend a layer of suitable insulation material is added to the mounting plate surface.
- 10mm above the components
- 3~5mm around the edges

Any of the holes shown above can be used for mounting the PCB, they are 3.2mm in diameter.

**CAUTION: Ensure adequate insulation is provided for all areas of the PCB with special attention to high voltage parts such as the inverter.**

## APPLICATION NOTES

### USING THE CONTROLLER WITHOUT BUTTONS ATTACHED

This is very straightforward:

- Firstly setup the controller/display system with the buttons. With controls attached and display system active make any settings for colour, tint and image position as required then switch everything off.
- Remove the control switches, the 12-way (CNC1) cable.
- Use a jumper or similar to connect pins 1 & 2 on CNC1, this will fix the board On.
- Refer to inverter specifications for details as to fixing brightness to a desired level, this may require a resistor, an open circuit or closed circuit depending on inverter.

**Summary:** On CNC1 the only pins that are used are for On/Off and Brightness (if controller mounted inverter is used). On CNC1 the pins are for momentary type buttons so it doesn't matter that no buttons are attached.

### INVERTER CONNECTION

There are potentially 3 issues to consider with inverter connection:

- Power
- Enable
- Brightness

Please read the following sections for a guide to these issues.

**Inverter Power:** As per the table for CNB1 pin 1 is ground and pin 2 provides 12V / 24V DC. This should be matched with the inverter specification: see table.

#### CNB1

PIN	DESCRIPTION
1	Ground
2	+12V / +24V DC

Remark: For higher power inverter, more current (for 12V) can be taken from CNA1 pin 1.

**Enable:** This is a pin provided on some inverters for On/Off function and is used by this panel controller for VESA DPMS compliance. If the inverter does not have an enable pin or the enable pin is not used then DPMS will not be operational. Pin 3 should be matched to the inverters specification for the 'enable' or 'disable' pin.

#### CNB1

PIN	DESCRIPTION
3	Enable

Further, jumpers JB2 & JB3 should be set to match the inverters specification for the enable pin power and High or Low setting: see table.

Ref	Purpose	Note
JB2	Inverter enable voltage	1-2 H = 12V / 24V,, 2-3 H = 5V (Vcc), OPEN H = open collector
JB3	Inverter control	1-2 H = On, 2-3 L = On

**Brightness:** There are various methods for brightness control and it is important to consider the specifications for the inverter to be used. Generally the situation is:

- Brightness can control by using a resistor or VR (Variable Resistor).
- Brightness controlled by adding a circuit such as PWM (Pulse Width Modulation).
- No adjustment of brightness is possible.

CNB1 pins 4 & 5 are available for connecting to an inverter or circuit where VR control is supported.

#### CNB1

PIN	DESCRIPTION
4	VR WIP
5	VR A

This can then be matched with function controls connected to CNC1 pins 4 & 3 or 5: see table.

#### CNC1

PIN	DESCRIPTION
3	VR A
4	VR WIP
5	VR B

**Design Guideline for making VR circuitry :**

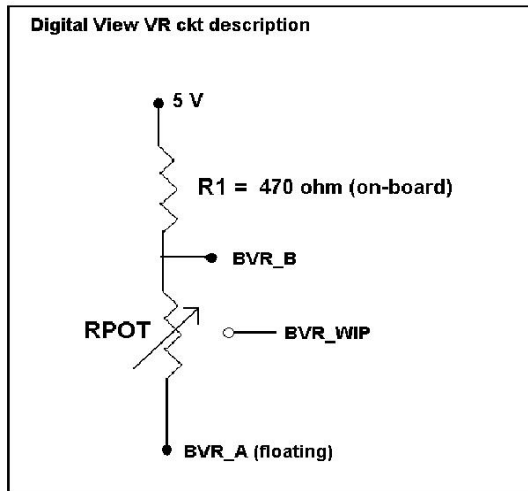

**Signal description / Notes :**

- 1) R1 : 470ohm on board
- 2) RPOT is an external potentiometer (in-line dip style) that can be plugged directly into CNC1 pins 3,4,5. RPOT must be supplied / installed by user.
- 3) BVR\_B : Voltage tapped from “top” of potentiometer, the node of R1 and RPOT.
- 4) BVR\_WIP : Voltage tapped from wiper arm of RPOT.
- 5) BVR\_A : Voltage tapped from “bottom” of RPOT.

**Note :** BVR\_A voltage is left floating on the controller board. To use this circuit, you need to tie this point to a potential (usually GND, available at CNC1 pin 6).

**CNB1 – Backlight inverter connector: JST B5B-XH-A (Matching type : XHP-5)**

PIN	SYMBOL	DESCRIPTION
1	GND	Ground
2	VBKL	+12V / 24VDC, backlight power supply
3	BLCTRL	On/Off control (enable) – see JB2 & JB3
4	BVR_WIP	Brightness VR - WIP
5	BVR_A	Brightness VR A

**CNC1 – Control switch, JST B12B-XH-A (Matching type : XHP-12)**

PIN	SYMBOL	DESCRIPTION
1	PSWIN	Power button A
2	SW_ON	Power button B
3	BVR_A	Backlight Brightness VR pin A
4	BVR_WIP	Backlight Brightness R pin WIP
5	BVR_B	Backlight Brightness VR pin B (470 ohm resistor to +5V Vcc)
6	GND	Ground
7	MENU	OSD menu
8	-/LEFT	OSD -/Left
9	+ /RIGHT	OSD +/Right
10	SEL_DN	OSD Select down
11	SEL_UP	OSD Select up
12	NC	No connection

The VR for brightness depends on the inverter. The main power load for On/Off is handled by a relay on the controller.

**Example for circuit design :**

- 1.) Choose RPOT = 10K
- 2.) Tie BVR\_A to GND
- 3.) Circuit analysis gives BVR\_WIP as the following (see Figure 1)

$$BVR\_WIP = 5 \times (Rbc/10.47)$$

where BVR\_WIP is in Volts.  
And Rbc is the resistance from the wiper arm to bottom of pot in Kohms.

To evaluate, plug in different values of Rbc :

Rbc	BVR_WIP
0	0 V
2.5 K	1.2 V
5 K	2.4 V
7.5 K	3.6 V
10 K	4.8 V

So this circuit could provide Brightness adjust voltage ranging from 0V to 5V.

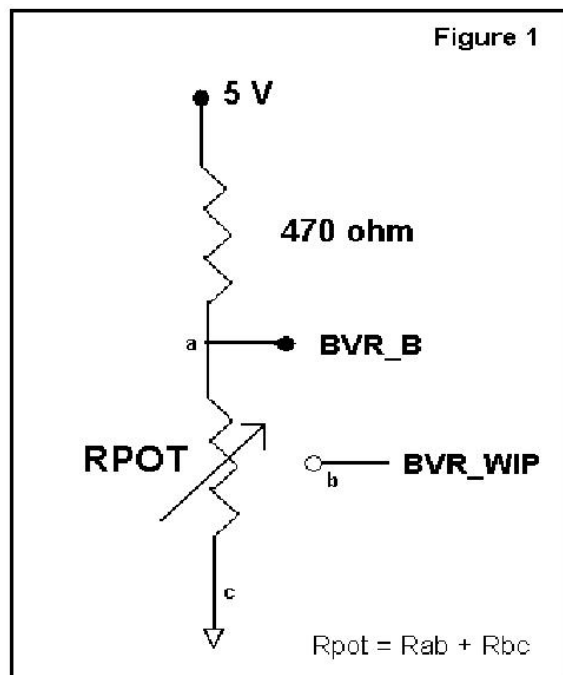

---

## TROUBLESHOOTING

### General

A general guide to troubleshooting a flat panel display system it is worth considering the system as separate elements, such as:

- Controller (jumpers, PC settings)
- Panel (controller, cabling, connection, panel, PC settings)
- Backlight (inverter, cabling, backlight tubes)
- Cabling
- Computer system (display settings, operating system)

Through step by step cross checking with instruction manuals and a process of elimination to isolate the problem it is usually possible to clearly identify the problem area.

### No image:

- If the panel backlight is not working it may still be possible to just see some image on the display.
- A lack of image is most likely to be caused by incorrect connection, lack of power, failure to provide a signal or incorrect graphic card settings.

### Image position:

If it is impossible to position the image correctly, i.e. the image adjustment controls will not move the image far enough, then test using another graphics card. This situation can occur with a custom graphics card that is not close to standard timings or if something is in the graphics line that may be affecting the signal such as a signal splitter (please note that normally a signal splitter will not have any adverse effect).

### Image appearance:

- A faulty panel can have blank lines, failed sections, flickering or flashing display
- Incorrect graphics card refresh rate, resolution or interlaced mode will probably cause the image to be the wrong size, to scroll, flicker badly or possibly even no image.
- Incorrect jumper settings on the controller may cause everything from total failure to incorrect image. CAUTION: Do not set the panel power input incorrectly.
- Sparkling on the display: faulty panel signal cable.

### Backlight:

Items to check include: Power input, Controls, Inverter and Tubes generally in this order.

If half the screen is dimmer than the other half:

- Check cabling for the inverter.
- For a specific backlight tube check the AC pins orientation (CAUTION: Never reverse any DC power pins).

Also:

- If adjusting brightness control has no effect the chances are that the VR rating or method of adjusting brightness is not compatible or correctly connected to the inverter.
- If system does not power down when there is a loss of signal

### Continued failure:

If unit after unit keeps failing consider and investigate whether you are short circuiting the equipment or doing something else seriously wrong.

Generally after common sense issues have been resolved we recommend step by step substitution of known working parts to isolate the problem.

## SPECIFICATIONS

Panel compatibility	Compatible with 1600x1200, 1366x768, 1280x1024, 1280x800, 1280x768, 1024x768, 800x600 800x480 & 640x480 resolutions of TFT LCD panels from manufacturers  A specified firmware version and some factory adjustment may be required for individual panel timings.
No. of colours	Up to 3 x 8 bit providing 16.7 million colours.
Panel power	DC 3.3V, 5V, 12V, 18V
Panel signal	TTL(Single pixel) / LVDS
Vertical refresh rate	60Hz at UXGA & SXGA and up to 75Hz for other lower resolutions
Graphics formats	Standard VESA VGA, SVGA, XGA, SXGA, WXGA, UXGA. Other special formats through specified firmware version and factory adjustment.
Graphics auto mode detect	VGA, SVGA, XGA, SXGA, WXGA & UXGA interlaced and non-interlaced
Standard input at source (analog RGB)	VGA analog (15 pin) standard with automatic detection of: Digital Separate Sync; Composite Sync Sync On Green.
Video formats	PAL, NTSC & SECAM
Video inputs	ARGB 1 ARGB 2 DVI-I Composite video S-Video SD Component video (YCbCr)
Functions display	On screen display (OSD) of functions
OSD menu functions	Image controls: Brightness, Contrast, Saturation, Hue, Sharpness, Aspect size, Color temperature, Video Scaling, OSD position, OSD timeout, Source select, Hot keys, etc.
OSD menu controls available	Power On/Off Backlight brightness OSD Menu OSD Select up OSD Select down Setting + Setting -
Control interface	Buttons/IR / RS-232
Settings memory	Settings are stored in non volatile memory
PC Connectivity	VGA / SVGA / XGA / SXGA / UXGA analog or digital
Controller dimensions	179mm x 120.4mm (7.1" x 4.74")
Power consumption	10w approx. (not including panel power consumption)
Power load maximum	The controller has an overall 3Amp current limit.
Input voltage	12V/ 24VDC +/- 5%
Power protection	Fuse fitted (Resettable)
Storage temperature limits	-40°C to +70°C
Operating temperature limits	0°C to +60°C

### NOTES

Please note the following:

- For specific panel setup a sample of an LCD may be required (this will be returned) and a copy of the full technical specifications for the panel from the manufacturer.
- Re-layout and custom development services are available.

**APPENDIX I – SUPPORTED MODES TABLE AT ARGB PORT**

Mode	Resolution	Clk [MHz]	Horizontal freq [KHz]	Vertical freq [Hz]	Sync Mode
E1_70	640x350 70Hz	25.175	31.469	70.087	Digital Separate Sync
E2_70	640x400 70Hz	25.175	31.469	70.087	Digital Separate Sync
T_70	720x400 70Hz	28.322	31.469	70.087	Digital Separate Sync
T_70	720x400 70Hz	28.322	31.469	70.087	Sync On Green
V_60	640x480 60Hz	25.175	31.469	59.940	Digital Separate Sync
V_60	640x480 60Hz	25.175	31.469	59.940	Sync On Green
V_60	640x480 60Hz	25.175	31.469	59.940	Composite Sync
V_72	640x480 72Hz	31.500	37.861	72.809	Digital Separate Sync
V_72	640x480 72Hz	31.500	37.861	72.809	Sync On Green
V_72	640x480 72Hz	31.500	37.861	72.809	Composite Sync
V_75	640x480 75Hz	31.500	37.500	75.000	Digital Separate Sync
V_75	640x480 75Hz	31.500	37.500	75.000	Sync On Green
V_75	640x480 75Hz	31.500	37.500	75.000	Composite Sync
SV_56	800x600 56Hz	36.000	35.156	56.250	Digital Separate Sync
SV_56	800x600 56Hz	36.000	35.156	56.250	Sync On Green
SV_56	800x600 56Hz	36.000	35.156	56.250	Composite Sync
SV_60	800x600 60Hz	40.000	37.879	60.317	Digital Separate Sync
SV_60	800x600 60Hz	40.000	37.879	60.317	Sync On Green
SV_60	800x600 60Hz	40.000	37.879	60.317	Composite Sync
SV_72	800x600 72Hz	50.000	48.077	72.188	Digital Separate Sync
SV_72	800x600 72Hz	50.000	48.077	72.188	Sync On Green
SV_72	800x600 72Hz	50.000	48.077	72.188	Composite Sync
SV_75	800x600 75Hz	49.500	46.875	75.000	Digital Separate Sync
SV_75	800x600 75Hz	49.500	46.875	75.000	Sync On Green
SV_75	800x600 75Hz	49.500	46.875	75.000	Composite Sync



X_60	1024x768 60Hz	65.000	48.363	60.004	Digital Separate Sync
X_60	1024x768 60Hz	65.000	48.363	60.004	Sync On Green
X_60	1024x768 60Hz	65.000	48.363	60.004	Composite Sync
X_70	1024x768 70Hz	75.000	56.476	70.069	Digital Separate Sync
X_70	1024x768 70Hz	75.000	56.476	70.069	Sync On Green
X_70	1024x768 70Hz	75.000	56.476	70.069	Composite Sync
X_75	1024x768 75Hz	78.750	60.023	75.029	Digital Separate Sync
X_75	1024x768 75Hz	78.750	60.023	75.029	Sync On Green
X_75	1024x768 75Hz	78.750	60.023	75.029	Composite Sync
SX_60	1280x1024 60Hz	108	63.81	60.020	Digital Separate Sync
SX_60	1280x1024 60Hz	108	63.81	60.020	Sync On Green
SX_60	1280x1024 60Hz	108	63.81	60.020	Composite Sync
UX_60	1600x1200 60Hz	162	75.000	60	Digital Separate Sync
UX_60	1600x1200 60Hz	162	75.000	60	Sync On Green
UX_60	1600x1200 60Hz	162	75.000	60	Composite Sync
SUN1166	1152x900 66Hz	94.5	61.8	66	Digital Separate Sync
SUN1176_	1152x900 76Hz	108	71.8	76.1	Digital Separate Sync
SUN1276G	1280x1024 76Hz	135	81.1	76.1	Digital Separate Sync

Remark :

The controller has been designed to take a very wide range of input signals however to optimize the PC's graphics performance we recommend choosing 60Hz vertical refresh rate. To support on higher refresh rate over 60Hz, the LCD panel may not support.

## Appendix II – RS-232 control protocols

### RS-232 Serial control (Baud rate 2400, 8 bits, 1 stop bit and no parity)

*Physical connection :*

Controller side  
Connector interface : CN8  
Mating connector : JST XHP-6

Computer side  
Connector interface : Serial port  
Mating connector : DB9 Female

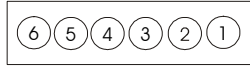

Mating face of CN8

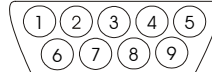

Mating face of RS-232 DB9 Male

PIN#	Description
4	RS-232 Tx Data
5	Ground
6	RS-232 Rx Data

PIN#	Description
2	RS-232 Rx Data
3	RS-232 Tx Data
5	Ground

Remark :

(1) : RS-232 connection cable, 600mm P/N 426090200-3 can be ordered separately for connection.

*Software connection :*

The OSD function can be controlled through sending the RS-232 protocol.

The RS-232 program can be custom-made to fit for application or it can be used the program provided by DigitalView on request. Please contact your local sales for information.

## 1. Commands to implement switch mount control buttons

Function	Command	Description	Remark
Menu button	0xf7	Menu button pressed	Button equivalent
Select-down button	0xfa	Select-down button pressed	Button equivalent
Select-up button	0xfb	Select-up button pressed	Button equivalent
Right/+ button	0xfc	Right/+ button pressed	Button equivalent
Left/- button	0xfd	Left/- button pressed	Button equivalent

## 2. Parameter setting - immediate, relative, reset and query

Function	Command	Description	Acknowledge (if enabled)
Volume control - left+right channel	0x80, "a"   "A", nn   "+"   "-"   "r"   "R"   "?"	Set audio (L+R) volume = value/increment/decrement Reset Query	volume  Range : "0" "0" ~ "1" "F" Default : "0" "A"
Volume control - on/off (mute)	0x80, "m"   "M", "0"   "1"   "r"   "R"   "?"	Disable audio output. Enable audio output. Reset Query	"0" - audio off (muted). "1" - audio on (Default)
Brightness control	0x81, nn   "+"   "-"   "r"   "R"   "?"	Set brightness = value/increment/decrement Reset Query	Brightness.  Range : "0" "0" ~ "6" "4" Default : "3" "2"
Contrast control	0x82, "a"   "A", nn   "+"   "-"   "r"   "R"   "?"	Set all contrast = value/increment/decrement Reset Query	Contrast  Range : "0" "0" ~ "6" "4" Default : "3" "2"
Saturation control	0x83, nn   "+"   "-"   "r"   "R"   "?"	Set saturation = value/increment/decrement Reset Query	PAL/NTSC saturation (In video mode only) Range : "0" "0" ~ "6" "4" Default : "3" "2"
Hue control	0x84, nn   "+"   "-"   "r"   "R"   "?"	Set hue = value/increment/decrement Reset Query	NTSC hue (In NTSC mode only)  Range : "0" "0" ~ "6" "4" Default : "3" "2"
Manual Phase	0x85, nn   "+"   "-"   "?"	Set dot clock phase = value/increment/decrement Query	Dot clock phase. (In PC mode only)
Image H position	0x86, nnnn   "+"   "-"   "r"   "R"   "?"	Set img_hpos = value/increment/decrement Reset Query	Image horizontal position. (In PC mode only)
Image V position	0x87, nnnn   "+"   "-"   "r"   "R"   "?"	Set img_vpos = value/increment/decrement Reset Query	Image vertical position. (In PC mode only)
Sharpness	0x8a, nn   "+"   "-"   "r"   "R"   "?"	Set sharpness = value/increment/decrement Reset Query	Sharpness.  Range : "0" "0" ~ "0" "F" Default : "0" "0"
Manual Clock	0x8b, nnnn   "+"   "-"   "?"	Set H active size = Value/increment/decrement Query	Graphic mode H active size (in pixels)
Scaling Mode	0x8c, "0"   "1"   "2"   "3" "r"   "R"   "?"	Set graphic image scaling mode = value Reset Query	Image expansion on/off. "0" – 1:1 "1" – fill screen (Default) "2" – fill aspect

OSD H position	0x90, nnn   "+"   "-"   "r"   "R"   "?"	Set osd_hpos = value/increment/decrement Reset Query	OSD horizontal position.
OSD V position	0x91, nnn   "+"   "-"   "r"   "R"   "?"	Set osd_vpos = value/increment/decrement Reset Query	OSD vertical position.
OSD Transparency	0x92, n   "+"   "-"   "r"   "R"   "?"	Set OSD transparency = value/increment/decrement Reset Query	OSD transparency.  Range : "0" "0" ~ "6" "4" Default : "3" "2"
Select menu timeout	0x93, nn   "+"   "-"   "r"   "R"   "?"	Select menu timeout = value/increment/decrement Reset Query	OSD menu timeout value. Range : "0" "0" ~ "1" "4" Default : "0" "A" "0" "0" – 0 second value – Round up to nearest available step. if value > max available step, set it to the max available step.
Select OSD language	0x95, n   "r"   "R"   "?"	Select language = English, Italian,... Reset Query	"0" – English. (Default) "8" – Chinese
Input main select	0x98, nn   "+"   "-"   "r"   "R"   "?"	Select input main = PC or VIDEO or next available Reset Query	Main selected.  0x41 0x31 : VGA 1 0x41 0x32 : VGA 2 0x42 0x31 : Composite 0x43 0x31 : S-video 0x44 0x31 : HD/SD Component 0x46 0x31 : DVI 0x47 0x31 : HD/SD Component  (Source sequence : VGA 1 → Composite → S-Video → VGA 2 → DVI → HD/SD Component)
Video System	0x9b, "0"   "1"   "2"   "3"   "r"   "R"   "?"	Set video system = Auto/NTSC/PAL/SECAM Reset Query	"0" – Auto (Default) "1" – NTSC "2" – PAL "3" – SECAM "4" – NTSC_443 (In video mode only)
GAMMA value select	0x9d, n   "r"   "R"   "?"	Select GAMMA value = Value Reset Query	GAMMA value: "0" – 1.0 (Default), "1" – 1.6 "2" – 2.2, "3" – User Defined
Auto power off	0x9f, "0"   "1"   "r"   "R"   "?"	Set power down option = On/Off Reset Query	"0" – Off. "1" – On (Default)
Direct Access (Hotkeys)	0xa0, "1", n   "r"   "R"   "?"	Set Hotkey 1 = Value Reset Query	"1" – volume. "2" – brightness (Default) "3" – contrast. "5" – input source "C" - Aspect
Direct Access (Hotkeys)	0xa0, "2", n   "r"   "R"   "?"	Set Hotkey 2 = value Reset Query	"1" – volume. "2" – brightness. "3" – contrast (Default) "5" – input source "C" - Aspect
Set runtime	0xa1,	Set runtime counter value =	Runtime = nnnnn.

counter	nnnn   "r"   "R"   "?"	nnnn (* 0.5 hour) Reset Query	
Colour temperature select	0xb3, n   "r"   "R"   "?"	Select colour temperature = value Reset Query	Main selected. "0" – 9300K. "1" – 8000K. (Default) "2" – 6500K. "3" – 5000K.
Red level for selected colour temperature	0xb4, nn   "+"   "-"   "r"   "R"   "?"	Set the level of the red channel for the selected colour temp. = value/increment/decrement Reset Query	Red level for selected colour temperature.
Green level for selected colour temperature	0xb5, nn   "+"   "-"   "r"   "R"   "?"	Set the level of the green channel for the selected colour temp. = value/increment/decrement Reset Query	Green level for selected colour temperature.
Blue level for selected colour temperature	0xb6, nn   "+"   "-"   "r"   "R"   "?"	Set the level of the blue channel for the selected colour temp. = value/increment/decrement Reset Query	Blue level for selected colour temperature.
Graphic horizontal resolution enquiry	0xb7	Horizontal resolution (in pixels) in 3 digit hex number	"nnn" = horizontal resolution
Graphic vertical resolution enquiry	0xb8	Vertical resolution (in lines) in 3 digit hex number	"nnn" = vertical resolution
Graphic horizontal sync frequency	0xb9	Horizontal sync frequency (in units of 100Hz) in 3 digit hex number	"nnn" = horizontal frequency
Graphic vertical sync frequency	0xba	Vertical sync frequency (in units of Hz) in 3 digit hex number	"nnn" = vertical frequency
OSD turn off	0xbd	Turn off the OSD.	"1" – successful.
Set gamma data for user defined gamma curve	0xbf, mm, c, "?"  0xbf, "R"   "r" 0xbf, mm, c, nn	Query gamma data for color c index mm ( c = 0 for color Red, c=1 for color Green, c=2 for color Blue) Set user gamma curve to linear Set gamma data for color c index mm. (If c= 3, then gamma data for red, green & blue will be set at the same time.)	"nn" = gamma data  "1" "nn" = gamma data
Query firmware version	0xcb, "0"	Read BIOS version	BIOS version "VV.YY.ZZ" VV = V0 or E0, V0 = Release version E0 = Engineering Sample  YY= Version Number  ZZ= Customer Number
Backlight Brightness control	0xe0, nn   "+"   "-"   "r"   "R"   "?"	Set Backlight = value/increment/decrement Reset Query	Set backlight brightness to "10" → 0xe0 0x31 0x30  * Need to short JB5 to 3-4 closed for enabling the backlight brightness control.  * Apply for inverter control voltage in range of 0~5V.
Backlight On/Off	0xe1, "0"   "1"	Backlight Off / Backlight On /Status	"0" – Backlight Off "1" – Backlight On.

	"?"		"?" – Backlight On/Off Query
--	-----	--	------------------------------

### 3. Other control

Function	Command	Description	Acknowledge (if enabled)
Auto-setup	0xc3	Start auto-setup of current vmode.	"0" – fail. "1" – successful.
Command availability	0xc4, nn	Check whether a command is available.	"0" – not available. "1" – available.
Auto-calibration	0xc5	Start auto-calibration of gain of the RGB amplifier.	"0" – fail. "1" – successful.
Soft Power On/Off	0xc8, "0"   "1"   "?"	Soft power off/on query	"0" – soft power off. "1" – soft power on.
Query video input status	0xc9	Query the status of the primary & pip status	"nn,nn" = input status "nn,xx" digit = primary status: "0", "0" : invalid "A", "1" ARGB "A", "2" ARGB 2 "B", "1" Composite "C", "1" S-video "D", "1" HD/SD Component "F", "1" DVI  "xx,nn"= PIP input status: "0", "0": invalid
Reset to factory defaults	0xce	Reset all parameters to default value	"1" – successful.

n = 1-byte ascii-coded hex number, e.g., parameter value of 0x1 is represented by "1" (0x31).

mn or nn = 2-byte ascii-coded hex number, e.g., parameter value of 0x1e is represented by "1", "e" | "E" (0x31, 0x6e|0x4e).

#### Hex to ASCII conversion table

Hex	ASCII	Hex	ASCII	Hex	ASCII	Hex	ASCII
0x30	0	0x41	A	0x61	a	0x2B	+
0x31	1	0x42	B	0x62	b	0x2D	-
0x32	2	0x43	C	0x63	c	0x3F	?
0x33	3	0x44	D	0x64	d		
0x34	4	0x45	E	0x65	e		
0x35	5	0x46	F	0x66	f		
0x36	6	0x47	G	0x67	g		
0x37	7	0x48	H	0x68	h		
0x38	8	0x49	I	0x69	i		
0x39	9	0x4A	J	0x6A	j		
		0x4B	K	0x6B	k		
		0x4C	L	0x6C	l		
		0x4D	M	0x6D	m		
		0x4E	N	0x6E	n		
		0x4F	O	0x6F	o		
		0x50	P	0x70	p		
		0x51	Q	0x71	q		
		0x52	R	0x72	r		
		0x53	S	0x73	s		
		0x54	T	0x74	t		
		0x55	U	0x75	u		
		0x56	V	0x76	v		
		0x57	W	0x77	w		
		0x58	X	0x78	x		
		0x59	Y	0x79	y		
		0x5A	Z	0x7A	z		

## Appendix III – Mapping definition

- Definition of Mapping A :

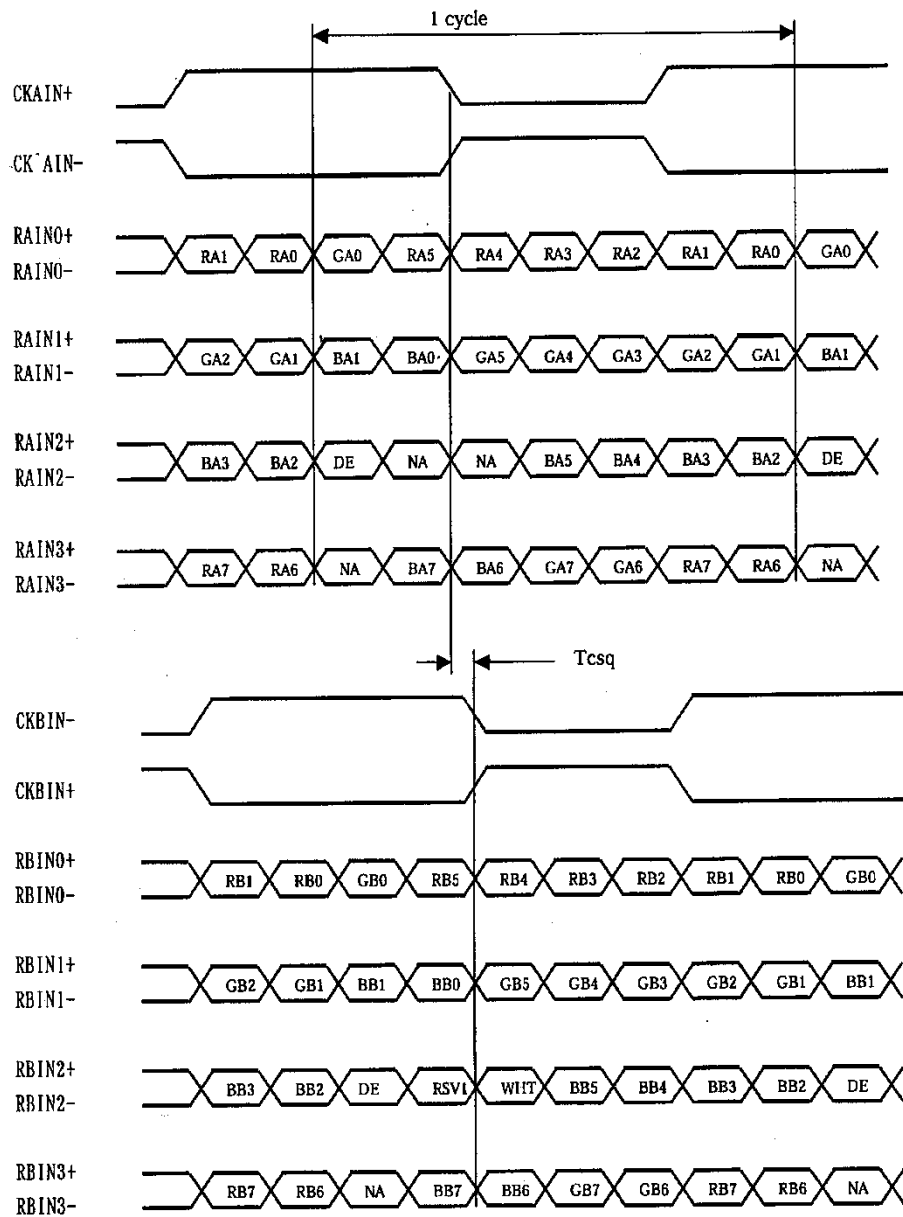

- Definition of Mapping B :

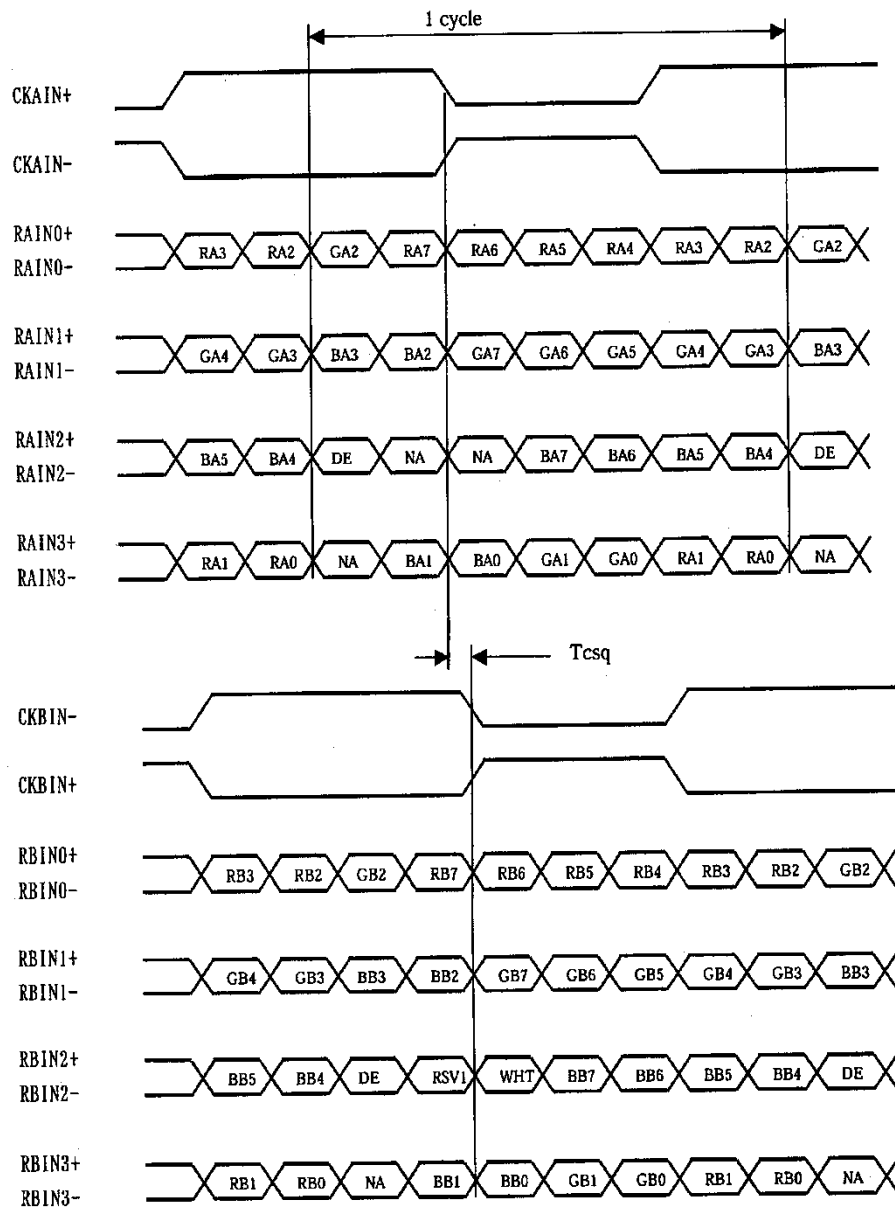



---

## Appendix IV – Auto Color Gain

The Auto Color Gain function is supported in the ARGB mode only and is designed to calibrate the controller to the incoming video signal. In order to calibrate correctly, the display must be displaying an image containing both black and white data (see illustration below) when the function is used. The internal processor of the video controller chip will then execute a process to adjust the relative values of the RGB signals to achieve the best performance. The parameters of the corrected RGB values are then stored in the controller and are unaffected by the Reset Factory Defaults function.



**Warning** - If the Auto Color Gain is executed without an appropriate image being displayed, then the process will set incorrect values and the display colors will be distorted. If this occurs, then it can either be corrected by performing the process correctly or if this is not possible then the Reset Color Gain function can be used. This function will reset the stored RGB values to a set of approximate values.

**Appendix V – Inverter Interface Board P/N 416040010-3  
[OPERATE UNDER 12VDC POWER INPUT ENVIRONMENT]**

The Inverter interface board provides interface to drive up the high current consumption panel inverter in excess of 3.5A. This board enables current of up to 8 Amps to be managed safely while retaining the capability for inverter dimming and management of the inverter enable signal according to VESA DPMS standards. Additionally, the inverter interface board provides over-voltage protection via a resettable fuse when the input voltage exceeds 13V and reverse polarity protection against accidental misconnection.

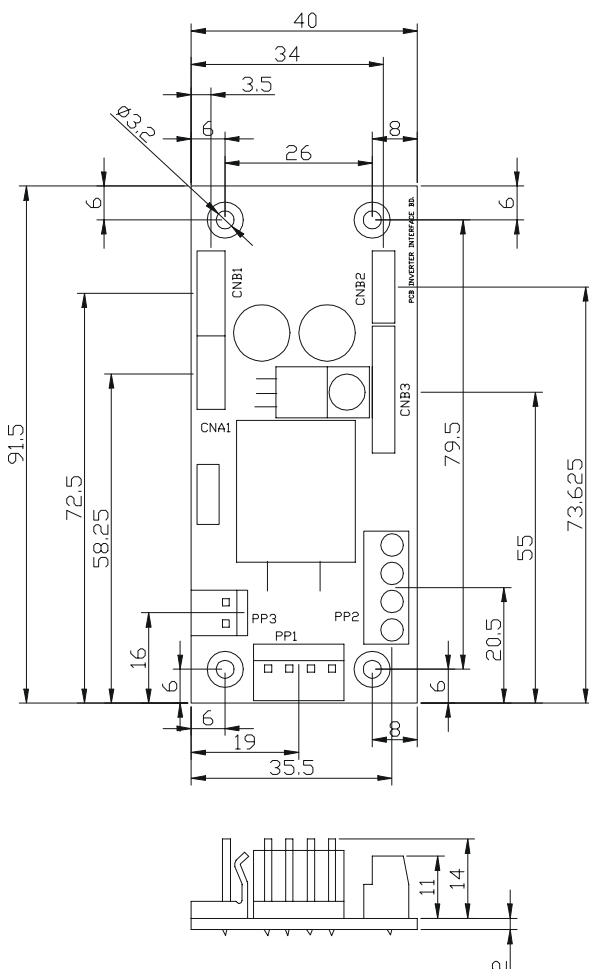

- Connector Type :**  
CNA1, CNB2 : JST 4 ways, B4B-XH-A  
CNB1 : JST 5 ways, B5B-XH-A  
CNB3 : JST 8 ways, B8B-XH-A  
PP1 : PWR 4 way  
PP2 : Terminal Block 2 poles x 2  
PP3 : PWR 2 ways

## Illustrated Diagram

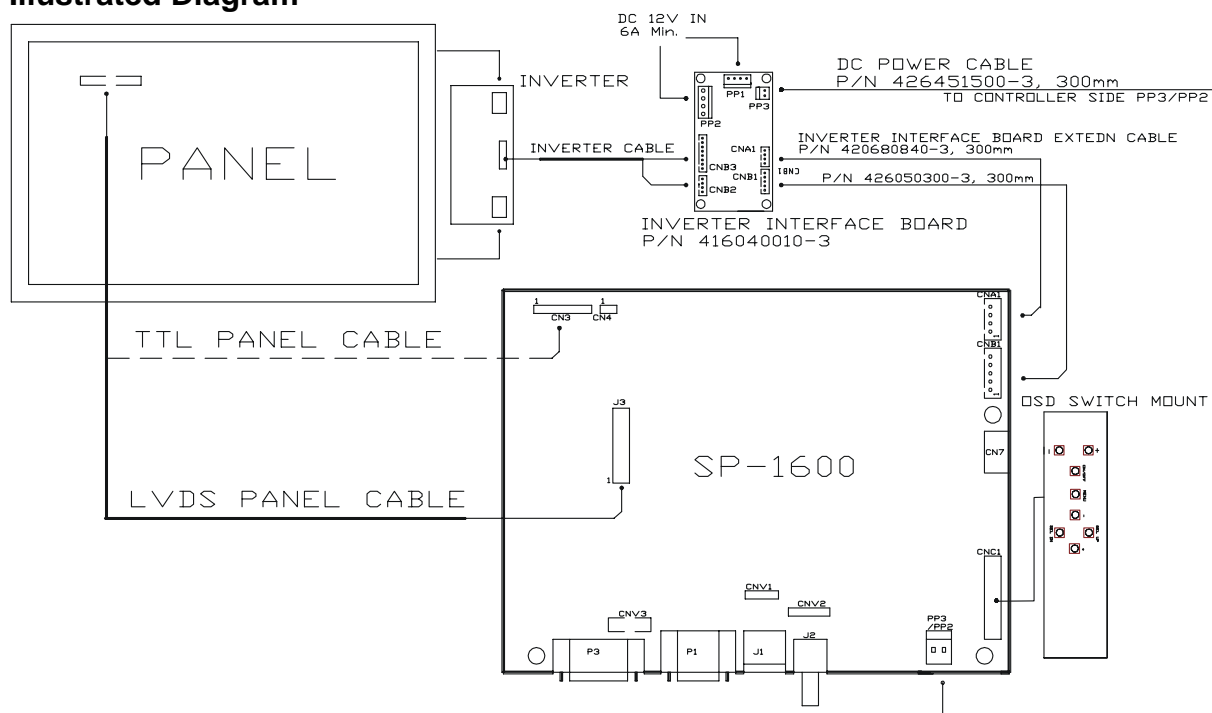

**PP1 - 12VDC power supply – input, Power header 4 ways 0.156” pitch**

PIN	DESCRIPTION
1	+12VDC
2	+12VDC
3	Ground
4	Ground

**PP2 – Alternate 12VDC power supply – input, Terminal Block 2 poles**

PIN	DESCRIPTION
1	+12VDC
2	+12VDC
3	Ground
4	Ground

**PP3 – 12VDC power supply to controller – Output, Power header 2 ways, 0.156” pitch**

PIN	DESCRIPTION
1	+12VDC
2	Ground

**CNA1 - Inverter interface to controller, JST B4B-XH-A**

PIN	SYMBOL	DESCRIPTION
1	NC	No connection
2	AUX_GND	Ground
3	AUX_GND	Ground
4	AUX_Vcc	+5V DC, 500mA max

**CNB1 – Inverter interface to controller, JST B5B-XH-A**

PIN	SYMBOL	DESCRIPTION
1	GND	Ground
2	BL_ON	Backlight power
3	BLCTRL	Backlight on/off control signal
4	BVR_WIP	Backlight brightness VR pin WIP
5	BVR_A	Backlight brightness VR pin A

**CNB2 – Inverter interface to backlight inverter, JST B4B-XH-A**

PIN	SYMBOL	DESCRIPTION
1	VLCD12	Panel power
2	AUX_GND	Ground
3	AUX_GND	Ground
4	AUX_Vcc	+5V DC, 500mA max

**CNB3 – Inverter interface to backlight inverter, JST B8B-XH-A**

<b>PIN</b>	<b>SYMBOL</b>	<b>DESCRIPTION</b>
1	VLCD12	Panel power
2	VLCD12	Panel power
3	GND	Ground
4	GND	Ground
5	VLCD12	Panel power
6	BLCTRL	Backlight on/off control signal
7	BVR_WIP	Backlight brightness VR pin WIP
8	BVR_A	Backlight brightness VR pin A

---

---

## **WARRANTY**

The products are warranted against defects in workmanship and material for a period of three (3) year from the date of purchase provided no modifications are made to it and it is operated under normal conditions and in compliance with the instruction manual.

The warranty does not apply to:

- Product that has been installed incorrectly, this specifically includes but is not limited to cases where electrical short circuit is caused.
- Product that has been altered or repaired except by the manufacturer (or with the manufacturer's consent).
- Product that has subjected to misuse, accidents, abuse, negligence or unusual stress whether physical or electrical.
- Ordinary wear and tear.

Except for the above express warranties, the manufacturer disclaims all warranties on products furnished hereunder, including all implied warranties of merchantability and fitness for a particular application or purpose. The stated express warranties are in lieu of all obligations or liabilities on the part of the manufacturer for damages, including but not limited to special, indirect consequential damages arising out of or in connection with the use of or performance of the products.

---

## **CAUTION**

Whilst care has been taken to provide as much detail as possible for use of this product it cannot be relied upon as an exhaustive source of information. This product is for use by suitably qualified persons who understand the nature of the work they are doing and are able to take suitable precautions and design and produce a product that is safe and meets regulatory requirements.

---

## **LIMITATION OF LIABILITY**

The manufacturer's liability for damages to customer or others resulting from the use of any product supplied hereunder shall in no event exceed the purchase price of said product.

---

## **TRADEMARKS**

The following are trademarks of Digital View Ltd:

- Digital View
- SP-1600

---

## CONTACT DETAILS

**USA:** Digital View Inc.  
18440 Technology Drive  
Building 130  
Morgan Hill, CA 95037  
USA

**Tel:** (1) 408-782 7773      **Fax:** (1) 408-782 7883  
**Sales:** [ussales@digitalview.com](mailto:ussales@digitalview.com)

**EUROPE:** Digital View Ltd  
6 Marylebone Passage  
London  
W1W 8EX  
UK

**Tel:** (44) (0)20 7631 2150      **Fax:** (44) (0)20 7631 2156  
**Sales:** [uksales@digitalview.com](mailto:uksales@digitalview.com)

**ASIA:** Digital View Ltd  
16<sup>th</sup> floor Millennium City 3  
370 Kwun Tong Road  
Kwun Tong  
Hong Kong

**Tel:** (852) 2861 3615      **Fax:** (852) 2520 2987  
**Sales:** [hksales@digitalview.com](mailto:hksales@digitalview.com)

## WEBSITE

[www.digitalview.com](http://www.digitalview.com)

---

Brand names belong to their respective owners.  
Specifications subject to change without notice.

15 th issue: 21 June, 2011 (SP-1600 manual.doc)

© Digital View Ltd 2006-2011

# Mouser Electronics

Authorized Distributor

Click to View Pricing, Inventory, Delivery & Lifecycle Information:

[Digital View:](#)

[426003300-3](#)