

## Chip Type Specialty Polymer Aluminum Electrolytic Capacitors (SP Cap)

Japan

Series: **CB**

### ■ Features

- Low impedance at high frequency (10 kHz to 10 MHz) as low as ceramic capacitors (Reduced ESR due to an applying speciality polymer with high conductivity.)
- Excellent Noise-absorbent Characteristics
- Surface Mount (Reflow soldering method available)
- Very stable capacitance, impedance and ESR against temperature
- Excellent endurance characteristics due to adoption of solid electrolyte
- 4-terminal-construction helps further low impedance.

### ■ Specifications

Operating Temp. Range	-40 to +105 °C							
Rated W.V. Range	4 to 16 V.DC							
Nominal Cap. Range	2.2 to 82 μF							
Capacitance Tolerance	±20 % (120 Hz/+20 °C)							
DC Leakage Current	I ≤ 0.04 CV or 3 (μA) after 2 minutes (Whichever is the greater) (4W.V.:0.06CV)							
Dissipation Factor	≤ 0.06 (120 Hz/+20°C)							
Surge Voltage	Rated Working Voltage × 1.25 (15 to 35 °C)							
Endurance	<p>After applying rated working voltage for 1000 hours at +105 °C, and then being stabilized at +20 °C, capacitor shall meet the following limits.</p> <table border="1"> <tbody> <tr> <td>Capacitance change</td> <td>±10 % of initial measured value</td> </tr> <tr> <td>D.F.</td> <td>≤ Initial specified value</td> </tr> <tr> <td>DC leakage current</td> <td>≤ Initial specified value</td> </tr> </tbody> </table>		Capacitance change	±10 % of initial measured value	D.F.	≤ Initial specified value	DC leakage current	≤ Initial specified value
Capacitance change	±10 % of initial measured value							
D.F.	≤ Initial specified value							
DC leakage current	≤ Initial specified value							
Moisture Resistance	<p>After storing for 500 hours at +60 °C, 90 % R.H.</p> <table border="1"> <tbody> <tr> <td>Capacitance change</td> <td>+40 %, -20 % of initial measured value (4W.V.:+60 %, -20 % 6.3W.V.:+50 %, -20 %)</td> </tr> <tr> <td>D.F.</td> <td>≤ Initial specified value (4W.V., ECGC□□B□□□RA: ≤ 200 % of Initial specified value)</td> </tr> <tr> <td>DC leakage current</td> <td>≤ Initial specified value</td> </tr> </tbody> </table>		Capacitance change	+40 %, -20 % of initial measured value (4W.V.:+60 %, -20 % 6.3W.V.:+50 %, -20 %)	D.F.	≤ Initial specified value (4W.V., ECGC□□B□□□RA: ≤ 200 % of Initial specified value)	DC leakage current	≤ Initial specified value
Capacitance change	+40 %, -20 % of initial measured value (4W.V.:+60 %, -20 % 6.3W.V.:+50 %, -20 %)							
D.F.	≤ Initial specified value (4W.V., ECGC□□B□□□RA: ≤ 200 % of Initial specified value)							
DC leakage current	≤ Initial specified value							
Permissible Current Between Terminals with Same Polarity	2 A DC max. (This shall be applicable only when each terminal is landed or the circuit individually).							

Design, Specifications are subject to change without notice. Ask factory for technical specifications before purchase and/or use. Whenever a doubt about safety arises from this product, please inform us immediately for technical consultation without fail.

### ■ Explanation of Part Numbers

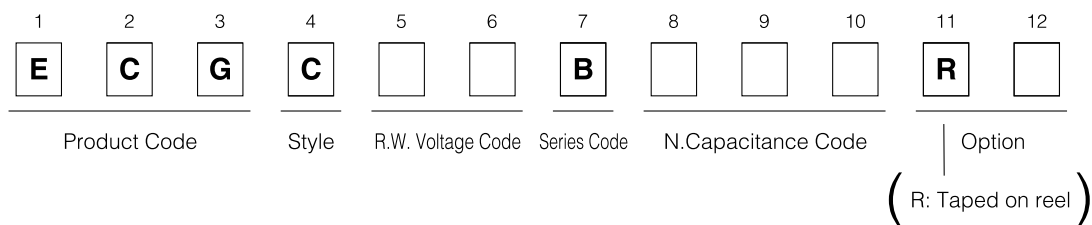

### ■ Marking

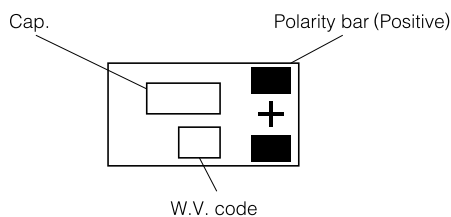

(V)	4	6.3	8	12.5	16
(W.V. code)	g	j	k	B	C

### ■ Dimensions in mm (not to scale)

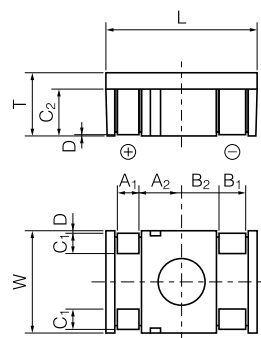

Size code	L ±0.2	W ±0.1	T ±0.1	A <sub>1</sub> ±0.1	A <sub>2</sub> ±0.1
	7.9	5.3	3.3	1.2	2.2
Size code	B <sub>1</sub> ±0.1	B <sub>2</sub> ±0.1	C <sub>1</sub> ±0.2	C <sub>2</sub> ±0.1	D ±0.1
	1.5	1.9	1.2	2.4	0

### ■ Standard product

Rated W.V. (V.DC)	Capacitance (μF)	Part number	Impedance (Ω) (400 kHz/+20 °C)	Ripple current (A r.m.s.) (100 kHz/ +20 ~ +105 °C)
4(0G)	15 (150)	ECGC0GB150R	0.11	1.3
	33 (330)	ECGC0GB330R	0.06	1.6
	47 (470)	ECGC0GB470R	0.05	1.6
	68 (680)	ECGC0GB680R	0.04	1.6
	82 (820)	ECGC0GB820RA	0.04	1.6
6.3 (0J)	10 (100)	ECGC0JB100R	0.13	1
	22 (220)	ECGC0JB220R	0.09	1.3
	33 (330)	ECGC0JB330R	0.06	1.6
	47 (470)	ECGC0JB470R	0.05	1.6
	68 (680)	ECGC0JB680RA	0.04	1.6
8 (0K)	8.2 (8R2)	ECGC0KB8R2R	0.14	1
	15 (150)	ECGC0KB150R	0.11	1.3
	22 (220)	EEFCD0K220R	0.09	1.6
	33 (330)	ECGC0KB330R	0.06	1.6
	47 (470)	ECGC0KB470RA	0.05	1.6
12.5 (1B)	4.7 (4R7)	ECGC1BB4R7R	0.18	1
	10 (100)	ECGC1BB100R	0.13	1
	15 (150)	ECGC1BB150R	0.11	1.3
	22 (220)	ECGC1BB220R	0.09	1.6
	33 (330)	EEFCD1B330RA	0.06	1.6
16 (1C)	2.2 (2R2)	ECGC1CB2R2R	0.38	1
	4.7 (4R7)	ECGC1CB4R7R	0.18	1
	6.8 (6R8)	ECGC1CB6R8R	0.15	1
	10 (100)	ECGC1CB100R	0.13	1

( ) shows W.V. and capacitance code.

Design, Specifications are subject to change without notice. Ask factory for technical specifications before purchase and/or use. Whenever a doubt about safety arises from this product, please inform us immediately for technical consultation without fail.

### ■ Mounting Specifications.

- Recommendable reflow soldering temperature

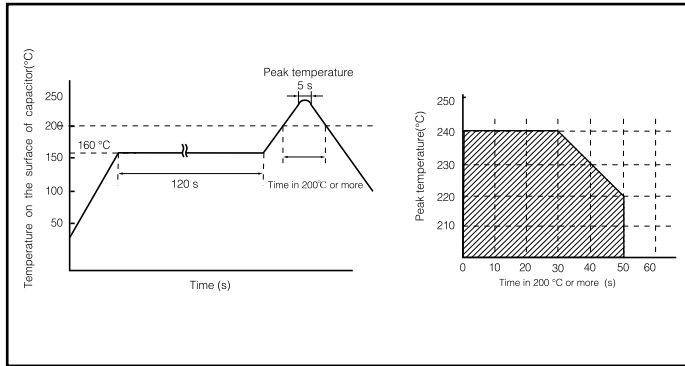

- Typical land pattern (mm)

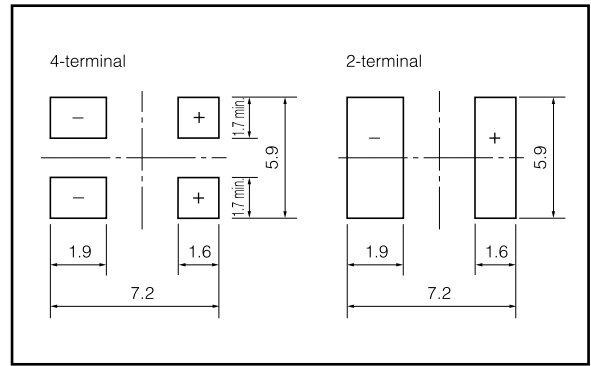

### ■ Packaging Specifications

- Reel Dimensions (mm)

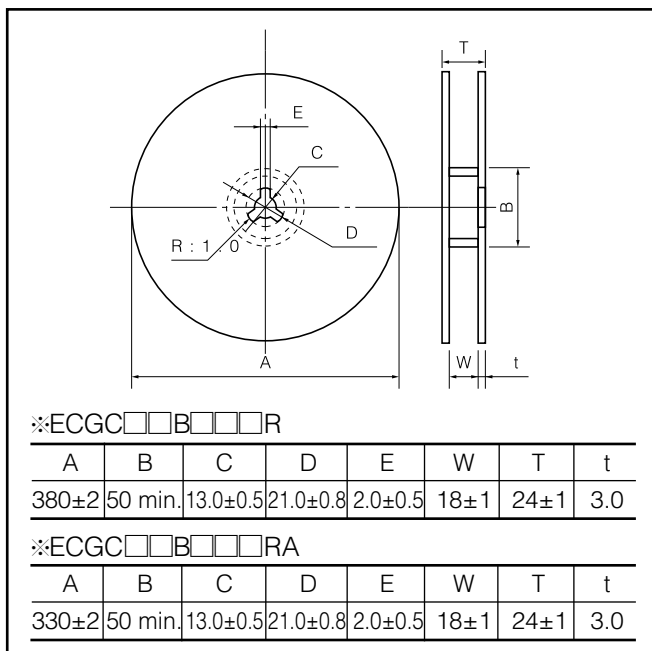

- Embossed Taping (mm)

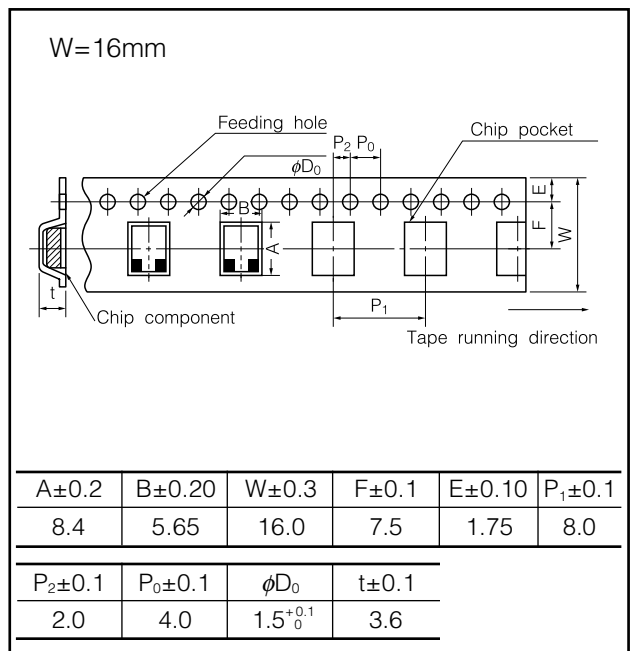

### ■ Packaging Quantity

※ECGC□□B□□□R

Embossed taping

3000 pcs./reel, 15000 pcs./box

※ECGC□□B□□□RA

Embossed taping

2200 pcs./reel, 11000 pcs./box

### ■ Packaging Box Dimensions (mm)

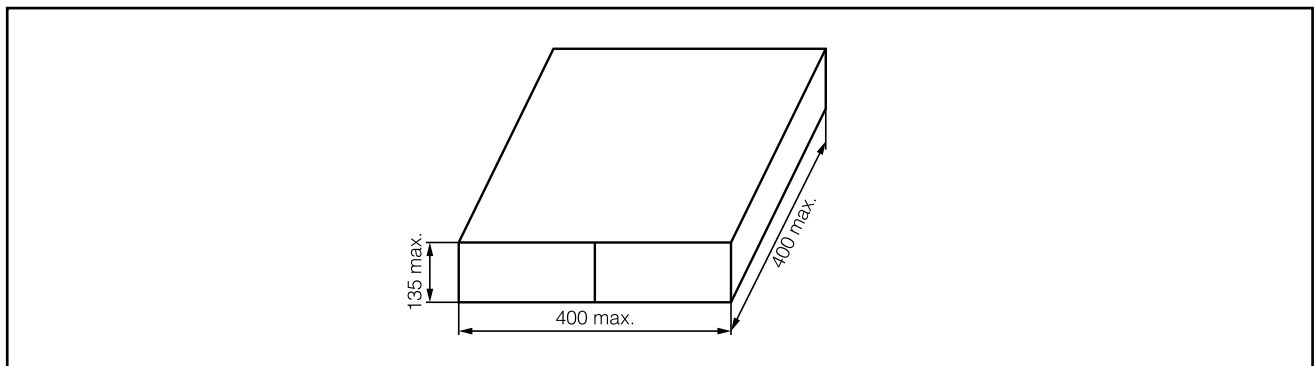

Design, Specifications are subject to change without notice. Ask factory for technical specifications before purchase and/or use. Whenever a doubt about safety arises from this product, please inform us immediately for technical consultation without fail.

## MEMO