

Multi - 6 Pack, Inductors and Transformers

Special Features

- Six windings offer many inductor or transformer configurations
- High magnetic coupling
- Non-gapped and gapped core construction
- Low core loss at high frequency applications
- Low noise radiation
- Compact size and low profile
- Dielectric strength: 500 Vrms between windings
- Operating temperature: -40 to +105 °C
- Tape & Reel packaging:
PM600, 600/reel
PM610, 300/reel
PM620, 200/reel

Typical Applications

- Inductors: buck, boost, buck-boost, coupled, input, output, choke, filter, resonant, high-Q, EMI/RFI filtering, differential, forward, common mode
- Transformers: flyback, forward, push-pull, bridge, multiple outputs, inverter, step-up, step-down, gate drive, base drive, signal, wide band, pulse, impedance, isolation, converter

Notes

* Saturation current is rated to each winding that causes inductance to drop 30 % from its initial value.

** Rms current is rated to each winding that causes 40 °C temperature rise.

PM600-01, -02, PM610-01, -02 and PM620-01, -02 are non-gap core.

| PM600/PM610/PM620 Series | | | | |
|--------------------------|------------------|--------------|-----------|------------|
| Part Number | L (μH) @ 100 KHz | DCR (Ω) Max. | Isat* (A) | Irms** (A) |
| PM600-01-RC | 201.6 ±30 % | 0.324 | 0.02 | 0.46 |
| PM600-02-RC | 89.6 ±30 % | 0.137 | 0.03 | 0.71 |
| PM600-03-RC | 27.4 ±10 % | 0.324 | 0.31 | 0.46 |
| PM600-04-RC | 12.2 ±10 % | 0.137 | 0.47 | 0.71 |
| PM600-05-RC | 14.7 ±10 % | 0.324 | 0.58 | 0.46 |
| PM600-06-RC | 6.5 ±10 % | 0.137 | 0.87 | 0.71 |
| PM600-07-RC | 10.9 ±10 % | 0.324 | 0.88 | 0.46 |
| PM600-08-RC | 4.9 ±10 % | 0.137 | 1.32 | 0.71 |
| PM600-09-RC | 8.5 ±10 % | 0.324 | 1.23 | 0.46 |
| PM600-10-RC | 3.8 ±10 % | 0.137 | 1.85 | 0.71 |
| PM610-01-RC | 160.0 ±30 % | 0.202 | 0.04 | 0.68 |
| PM610-02-RC | 78.4 ±30 % | 0.094 | 0.06 | 1.00 |
| PM610-03-RC | 21.6 ±10 % | 0.202 | 0.67 | 0.68 |
| PM610-04-RC | 10.6 ±10 % | 0.094 | 0.96 | 1.00 |
| PM610-05-RC | 11.6 ±10 % | 0.202 | 1.30 | 0.68 |
| PM610-06-RC | 5.7 ±10 % | 0.094 | 1.86 | 1.00 |
| PM610-07-RC | 8.3 ±10 % | 0.202 | 2.00 | 0.68 |
| PM610-08-RC | 4.1 ±10 % | 0.094 | 2.86 | 1.00 |
| PM610-09-RC | 6.6 ±10 % | 0.202 | 2.30 | 0.68 |
| PM610-10-RC | 3.2 ±10 % | 0.094 | 3.29 | 1.00 |
| PM620-01-RC | 160.6 ±30 % | 0.094 | 0.03 | 1.28 |
| PM620-02-RC | 77.0 ±30 % | 0.065 | 0.04 | 1.54 |
| PM620-03-RC | 131.8 ±20 % | 0.094 | 0.08 | 1.28 |
| PM620-04-RC | 63.2 ±20 % | 0.065 | 0.12 | 1.54 |
| PM620-05-RC | 23.3 ±10 % | 0.094 | 0.36 | 1.28 |
| PM620-06-RC | 11.2 ±10 % | 0.065 | 0.52 | 1.54 |
| PM620-07-RC | 14.2 ±10 % | 0.094 | 0.76 | 1.28 |
| PM620-08-RC | 6.8 ±10 % | 0.065 | 1.10 | 1.54 |
| PM620-09-RC | 9.3 ±10 % | 0.094 | 1.11 | 1.28 |
| PM620-10-RC | 4.5 ±10 % | 0.065 | 1.60 | 1.54 |
| PM620-11-RC | 7.9 ±10 % | 0.094 | 1.40 | 1.28 |
| PM620-12-RC | 3.8 ±10 % | 0.065 | 2.02 | 1.54 |

Available only as RoHS compliant beginning July 2007.

When ordering non-RoHS compliant versions before July 2007, do not include the -RC suffix in the part number.

BOURNS®

Tel. (877) 426-8767 • Fax (951) 781-5006

www.bourns.com

Multi - 6 Pack, Inductors and Transformers

Dimensions (mm)

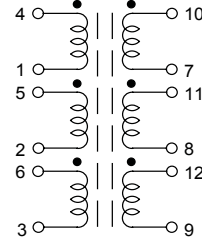
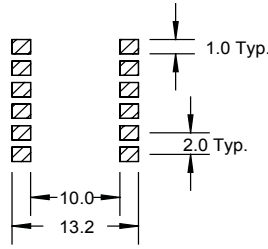
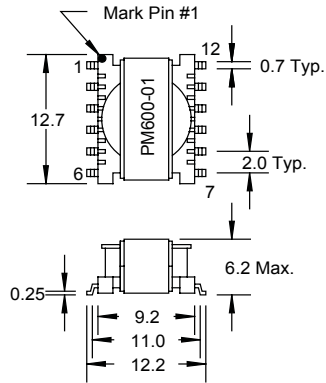

Pad Layout

PM600 - XX

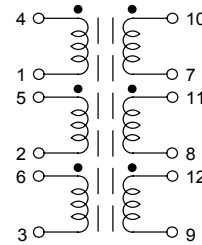
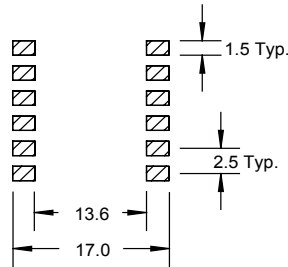
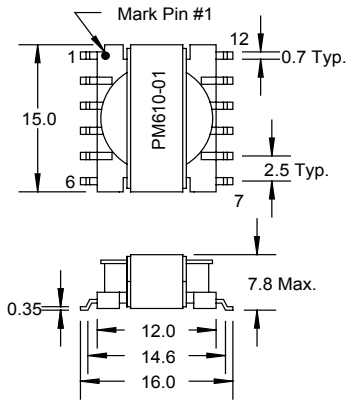

Pad Layout

PM610 - XX

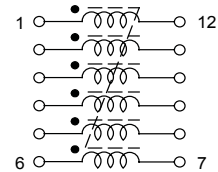
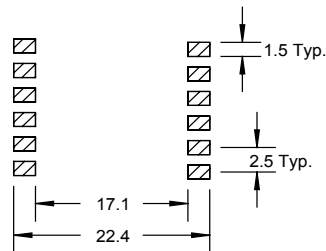
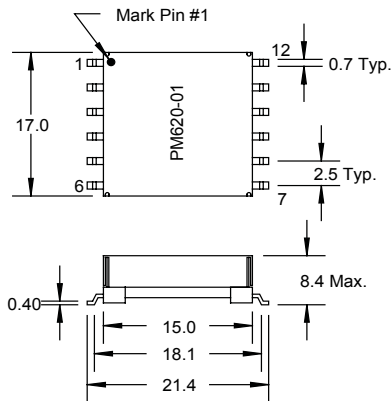

Pad Layout

PM620 - XX

Multi - 6 Pack, Inductors and Transformers

Typical Configurations

Inductor:

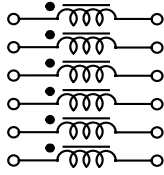

Basic Diagram
Inductance: L
Current: I

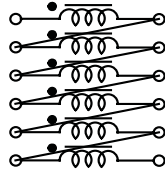

Figure 1
Inductance: $36 \times L$
Current: I

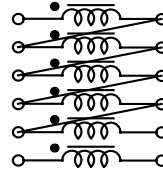

Figure 2
Inductance: $25 \times L$
Current: I

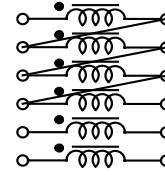

Figure 3
Inductance: $16 \times L$
Current: I

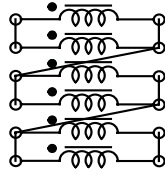

Figure 4
Inductance: $9 \times L$
Current: $2 \times I$

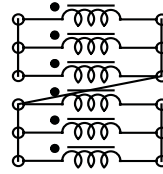

Figure 5
Inductance: $4 \times L$
Current: $3 \times I$

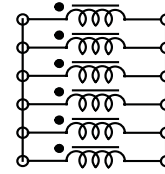
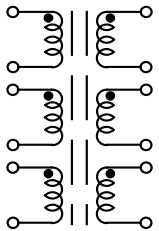

Figure 6
Inductance: L
Current: $6 \times I$

Transformer:



Basic Diagram
Turns ratio:
 $1:1:1:1:1:1$

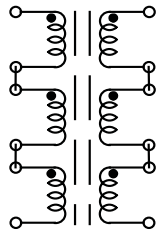

Figure 1
Turns ratio:
 $1:1$

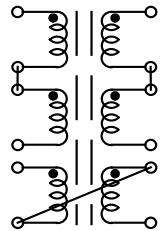

Figure 2
Turns ratio:
 $1:1:1$

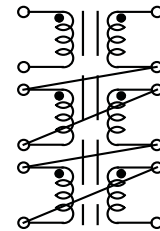

Figure 3
Turns ratio:
 $1:5$ or $5:1$

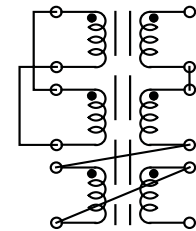

Figure 4
Turns ratio:
 $1:4$ or $4:1$

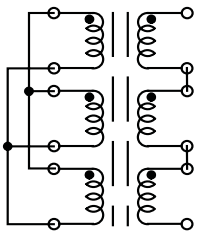

Figure 5
Turns ratio:
 $1:3$ or $3:1$

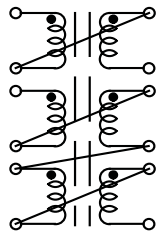

Figure 6
Turns ratio:
 $1:2$ or $2:1$

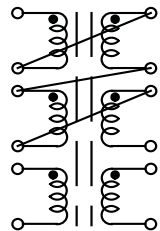

Figure 7
Turns ratio:
 $4:1:1$

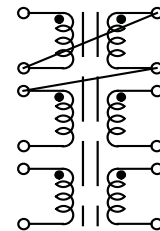

Figure 8
Turns ratio:
 $3:1:1:1$

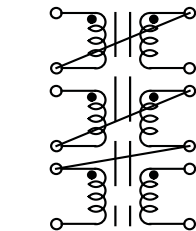

Figure 9
Turns ratio:
 $2:3$ or $3:2$