

General Purpose Transistors

PNP Silicon

● We declare that the material of product compliance with RoHS requirements.

L2SA1577QT1G Series

● ORDERING INFORMATION

Device	Package	Shipping
L2SA1577QT1G Series	SC-70	3000/Tape & Reel
L2SA1577QT3G Series	SC-70	10000/Tape & Reel

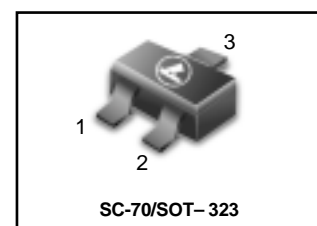

● Absolute maximum ratings (Ta = 25°C)

Parameter	Symbol	Limits	Unit
Collector-base voltage	V _{CBO}	-40	V
Collector-emitter voltage	V _{CEO}	-32	V
Emitter-base voltage	V _{EBO}	-5	V
Collector current	I _C	-0.5	A *
Collector power dissipation	P _C	0.15	W
Junction temperature	T _J	150	°C
Storage temperature	T _{stg}	-55~+150	°C

* P_C MAX. must not be exceeded.

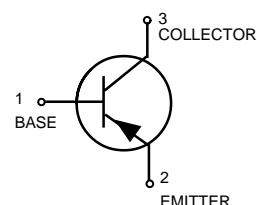

● DEVICE MARKING

L2SA1577PT1G =HP L2SA1577QT1G=HQ L2SA1577RT1G =HR

● ELECTRICAL CHARACTERISTICS (T_A = 25°C unless otherwise noted.)

Characteristic	Symbol	Min	Typ	Max	Unit
Collector-Emitter Breakdown Voltage (I _C = -1 mA)	V _{(BR)CEO}	-32	—	—	V
Emitter-Base Breakdown Voltage (I _E = -100 μA)	V _{(BR)EBO}	-5	—	—	V
Collector-Base Breakdown Voltage (I _C = -100 μA)	V _{(BR)CBO}	-40	—	—	V
Collector Cutoff Current (V _{CB} = -20 V)	I _{CBO}	—	—	-1	μA
Emitter cutoff current (V _{EB} = -4 V)	I _{EBO}	—	—	-1	μA
Collector-emitter saturation voltage (I _C /I _B = -100 mA / -10 mA)	V _{CE(sat)}	—	—	-0.4	V
DC current transfer ratio (V _{CE} = -3 V, I _C = -10mA)	h _{FE}	82	—	390	—
Transition frequency (V _{CE} = -5 V, I _E = 20mA, f=100MHz)	f _T	—	200	—	MHz
Output capacitance (V _{CB} = -10 V, I _E = 0A, f=1MHz)	C _{ob}	—	7.0	—	pF

● h_{FE} values are classified as follows:

*	P	Q	R
h _{FE}	82~270	120~270	180~390

L2SA1577QT1G SERIES

● Electrical characteristic curves

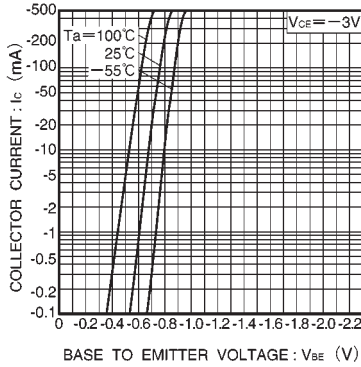

Fig.1 Grounded emitter propagation

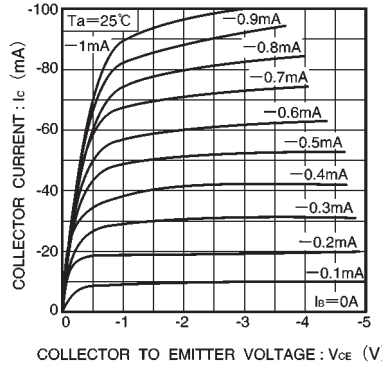

Fig.2 Grounded emitter output characteristics (I)

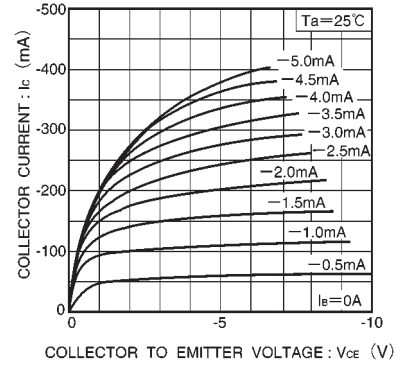

Fig.3 Grounded emitter output characteristics (II)

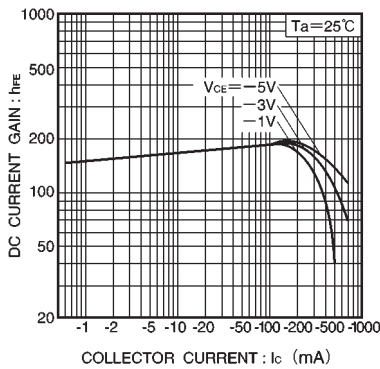

Fig.4 DC current gain vs. collector current (I)

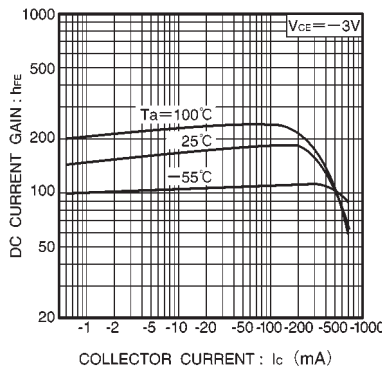

Fig.5 DC current gain vs. collector current (II)

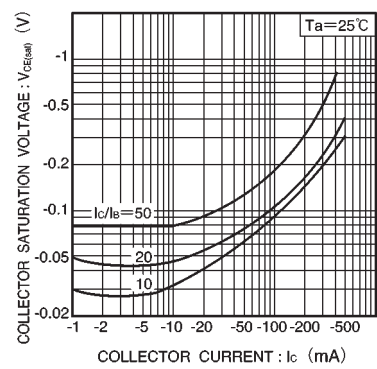

Fig.6 Collector-emitter saturation voltage vs. collector current (I)

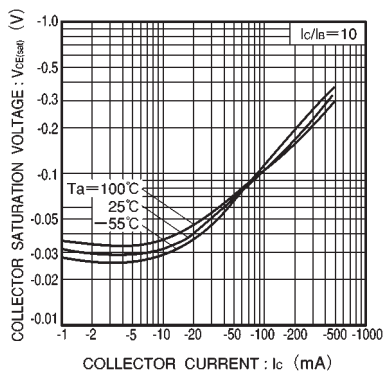

Fig.7 Collector-emitter saturation voltage vs. collector current (II)

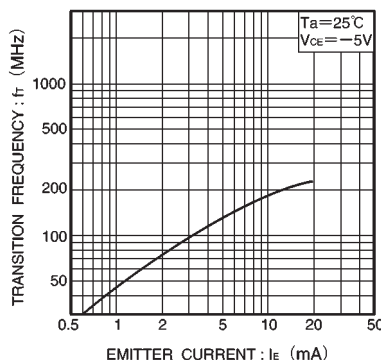

Fig.8 Gain bandwidth product vs. emitter current

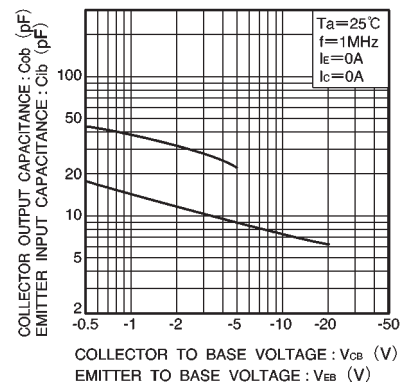
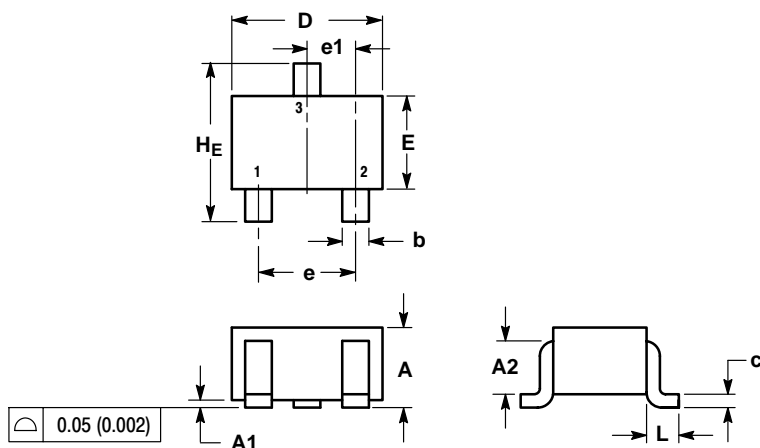

Fig.9 Collector output capacitance vs. collector-base voltage. Emitter input capacitance vs. emitter-base voltage

L2SA1577QT1G SERIES

SC-70/SOT-323



NOTES:
 1. DIMENSIONING AND TOLERANCING PER ANSI Y14.5M, 1982.
 2. CONTROLLING DIMENSION: INCH.

DIM	MILLIMETERS			INCHES		
	MIN	NOM	MAX	MIN	NOM	MAX
A	0.80	0.90	1.00	0.032	0.035	0.040
A1	0.00	0.05	0.10	0.000	0.002	0.004
A2	0.7 REF			0.028 REF		
b	0.30	0.35	0.40	0.012	0.014	0.016
c	0.10	0.18	0.25	0.004	0.007	0.010
D	1.80	2.10	2.20	0.071	0.083	0.087
E	1.15	1.24	1.35	0.045	0.049	0.053
e	1.20	1.30	1.40	0.047	0.051	0.055
e1	0.65 BSC			0.026 BSC		
L	0.425 REF			0.017 REF		
HE	2.00	2.10	2.40	0.079	0.083	0.095

0.05 (0.002)

SOLDERING FOOTPRINT*

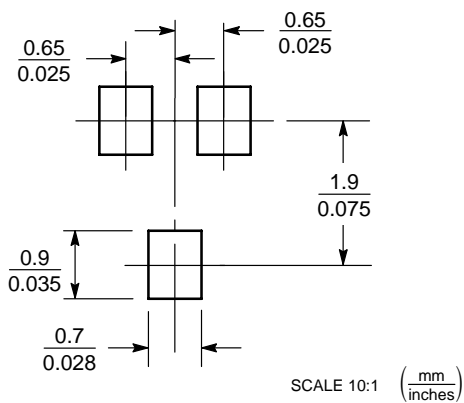

GENERIC MARKING DIAGRAM

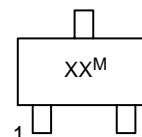

XX = Specific Device Code
 M = Date Code
 ▪ = Pb-Free Package

*This information is generic. Please refer to device data sheet for actual part marking. Pb-Free indicator, "G" or microdot "▪", may or may not be present.