

# **AX88772B Product Introduction**

Revision 1.11  
May 21<sup>st</sup>, 2012

## Revision History

Revision	Date	Description
1.00	2010/04/29	Initial release
1.10	2010/06/21	<ol style="list-style-type: none"><li>1. Added AX88772B USB to 100Base-TX Ethernet (with RMII) Demo Board related information.</li><li>2. Updated the Selection Guide in Section 3.</li><li>3. Updated AX88772B demo boards naming in Section 4 and 7.</li><li>4. Updated Figure 9 “AX88772B USB to 100Base-TX Ethernet Demo Board” picture in Section 7-1.</li><li>5. Modified some descriptions in Section 8.</li></ol>
1.11	2012/05/21	<ol style="list-style-type: none"><li>1. Updated the Selection Guide in Section 3.</li><li>2. Corrected a typo in Section 6.</li><li>3. Modified some descriptions in Section 8.</li></ol>

## Table of Contents

<b>1. Introduction .....</b>	<b>4</b>
<b>2. Block Diagram .....</b>	<b>5</b>
2-1. <i>Typical System Block Diagrams .....</i>	<i>6</i>
<b>3. Selection Guide .....</b>	<b>8</b>
<b>4. Ordering Information .....</b>	<b>9</b>
<b>5. Target Applications .....</b>	<b>10</b>
<b>6. Mass Production Solutions .....</b>	<b>11</b>
6-1. <i>Windows SROM Programming Tool .....</i>	<i>11</i>
6-2. <i>Windows Production Test Tool.....</i>	<i>12</i>
<b>7. AX88772B Demo Boards .....</b>	<b>13</b>
7-1. <i>AX88772B USB to 100Base-TX Ethernet Demo Board .....</i>	<i>13</i>
7-2. <i>AX88772B USB to 100Base-TX Ethernet (with RMII) Demo Board.....</i>	<i>14</i>
7-3. <i>AX88772B USB to 100Base-FX 1x9 SC Ethernet Demo Board .....</i>	<i>15</i>
7-4. <i>AX88772B USB to 100Base-FX POF Ethernet Demo Board .....</i>	<i>16</i>
<b>8. Related Technical Archives .....</b>	<b>18</b>

## List of Figures

Figure 1. Block Diagram.....	5
Figure 2. USB 2.0 to LAN Adaptor (MAC mode).....	6
Figure 3. USB 2.0 to Fast Ethernet and external PHYceiver Combo (MAC mode).....	6
Figure 4. Bridging Embedded MCU to USB 2.0 Host Interface (PHY mode) .....	7
Figure 5. USB 2.0 to HomePlug Adaptor (PHY mode) .....	7
Figure 6. Selection Guide.....	8
Figure 7. Ordering Information .....	9
Figure 8. Target Applications.....	10
Figure 9. Windows SROM Programming Tool .....	11
Figure 10. Windows Production Test Tool .....	12
Figure 11. AX88772B USB to 100Base-TX Ethernet Demo Board.....	13
Figure 12. AX88772B USB to 100Base-TX Ethernet (with RMII) Demo Board .....	14
Figure 13. AX88772B USB to 100Base-FX 1x9 SC Ethernet Demo Board .....	15
Figure 14. AX88772B USB to 100Base-FX POF Ethernet Demo Board.....	16
Figure 15. AX88772B USB to 100Base-TX/FX Ethernet with RMII Demo Boards Jumper Setting Table	17
Figure 16. Related Technical Archives .....	19
Figure 17. Technical Archives Availability Type .....	19

## 1. Introduction

The AX88772B Low-power USB 2.0 to 10/100M Fast Ethernet controller is a high performance and highly integrated ASIC which enables low cost, small form factor, and simple plug-and-play Fast Ethernet network connection capability for desktops, notebook PC's, Ultra-Mobile PC's, docking stations, game consoles, digital-home appliances, and any embedded system using a standard USB port.

The AX88772B features a USB interface to communicate with a USB Host Controller and is compliant with USB specification V1.1 and V2.0. The AX88772B implements a 10/100Mbps Ethernet LAN function based on IEEE802.3, and IEEE802.3u standards with embedded SRAM for packet buffering. The AX88772B integrates an on-chip 10/100Mbps Ethernet PHY to simplify system design.

The AX88772B provides an optional Multi-Function-Bus portion A and B (MFA and MFB) for external PHY or external MAC for different application purposes. The MFA/MFB can be a reduce-media-independent interface (RMII) for implementing 100BASE-FX Ethernet or HomePNA functions. The MFA/MFB can also be a Reverse Reduced-MII (Reverse-RMII) for glueless MAC-to-MAC connections to any MCU with Ethernet MAC RMII interface. In addition, the MFA/MFB can be configured as general purpose I/O.

The following URL provides detailed online resources of ASIX Electronics high-speed USB-to-LAN solutions:  
(Refer to <http://www.asix.com.tw/products.php?op=ProductList&PLine=71>)

### **Low-power USB2.0 to 10/100M Fast Ethernet Controller**

[AX88772B](#) -- Low-Power USB2.0 to 10/100M Fast Ethernet Controller

This document provides an overview of AX88772B Low-Power USB to 10/100M Fast Ethernet controller product.

## 2. Block Diagram

The following is AX88772B block diagram,

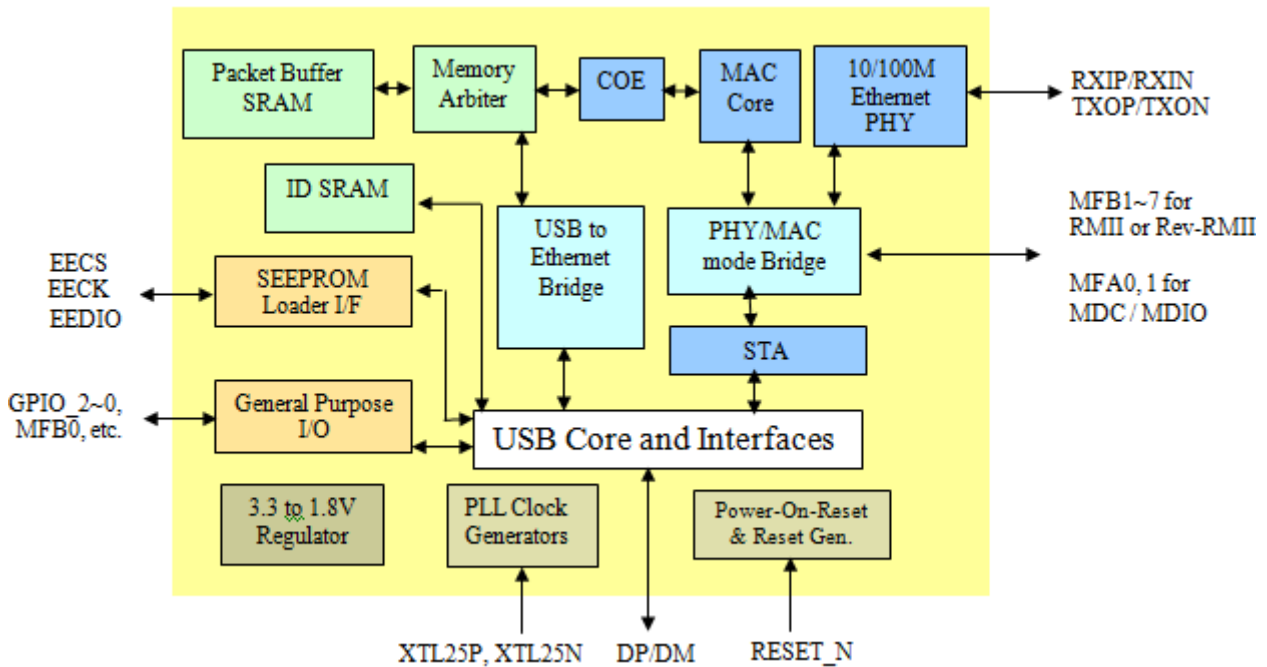

Figure 1. Block Diagram

## 2-1. Typical System Block Diagrams

- Hosted by USB to operate with internal Ethernet PHY only

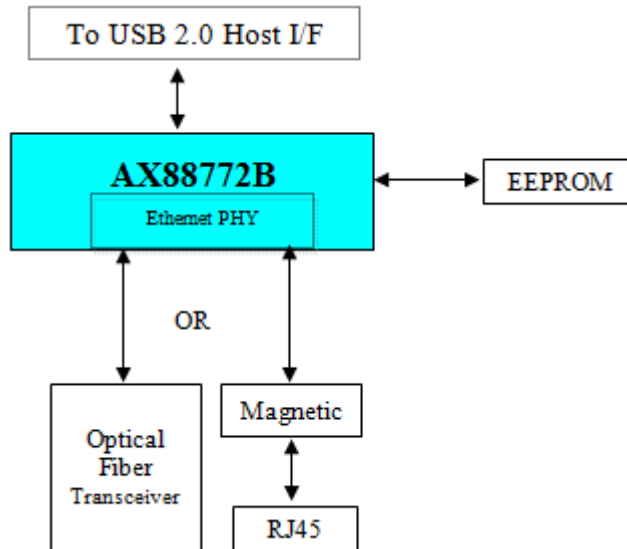

Figure 2. USB 2.0 to LAN Adaptor (MAC mode)

- Hosted by USB to operate with either internal Ethernet PHY or RMII (in MAC mode)

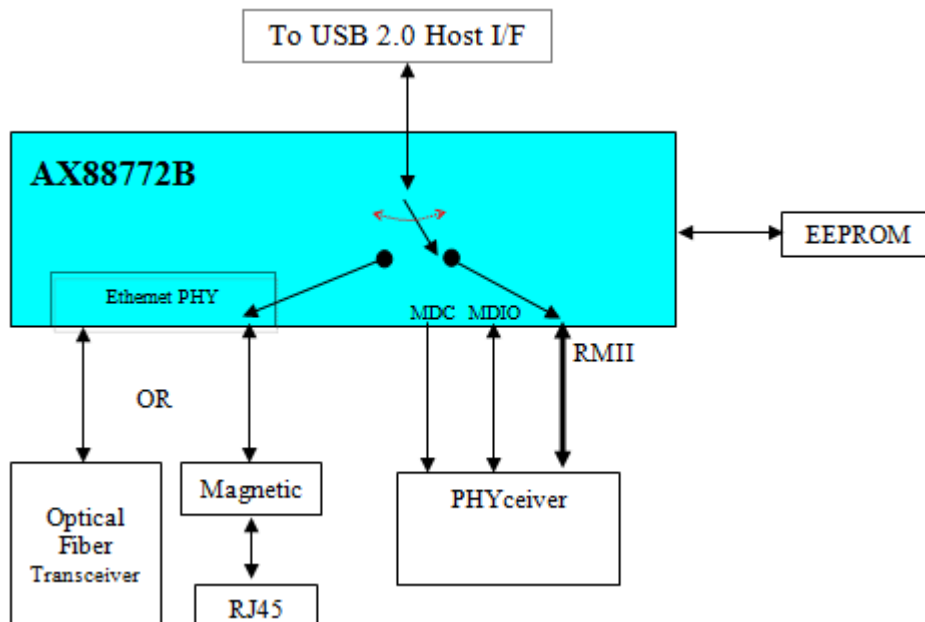

Figure 3. USB 2.0 to Fast Ethernet and external PHYceiver Combo (MAC mode)

- Hosted by USB to operate with either internal Ethernet PHY (in MAC mode) or Reverse-RMII (in PHY mode)

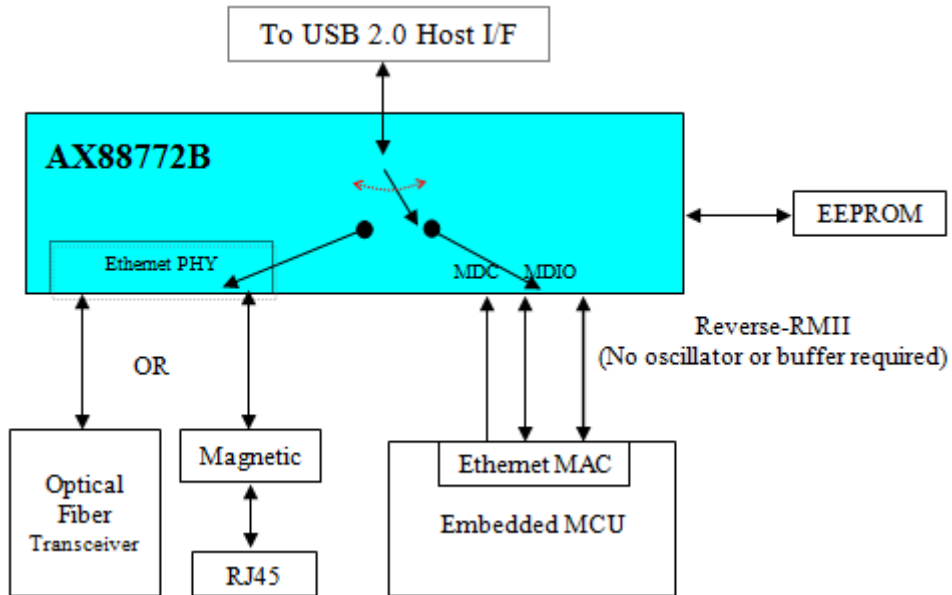

Figure 4. Bridging Embedded MCU to USB 2.0 Host Interface (PHY mode)

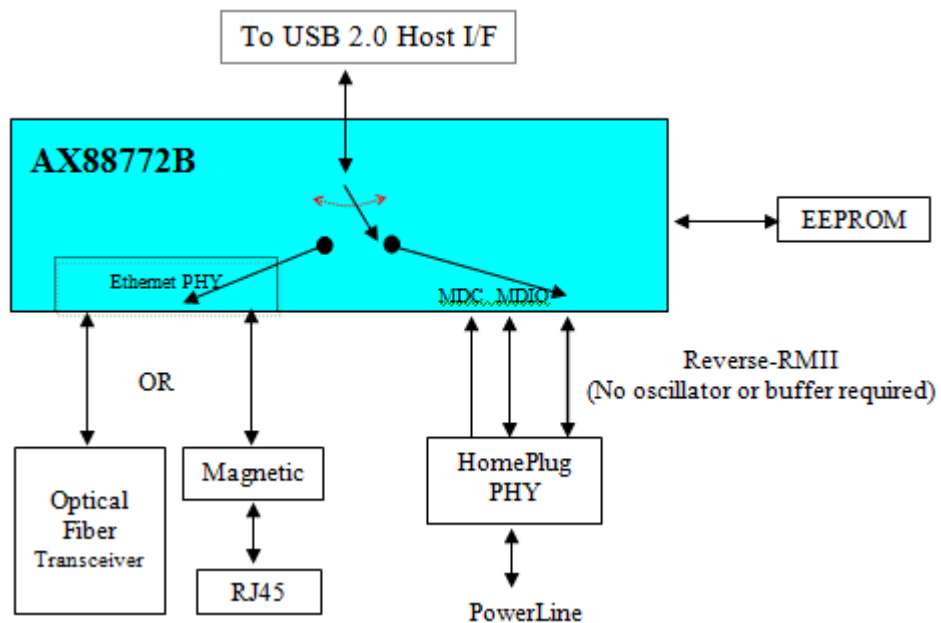

Figure 5. USB 2.0 to HomePlug Adaptor (PHY mode)

## 3. Selection Guide

The following is the selection guide of ASIX Electronics USB to Ethernet family for different requirement applications. Please visit ASIX Electronics' High-Speed USB-to-LAN product web page (<http://www.asix.com.tw/products.php?PLine=71>) and contact ASIX's Sales ([sales@asix.com.tw](mailto:sales@asix.com.tw)) for details.

Part No.	USB Speed	USB Hub	Ethernet MAC/PHY (Mbps)	MAC Interface	Crossover Detection and Auto-correction
AX88179	Super (3.0)	-	10/100/1000	-	v
AX88178	High (2.0)	-	10/100/1000 (MAC only)	MII/GMII/RGMII	-
AX88760	High (2.0)	3-Port	10/100	-	v
AX88772B	High (2.0)	-	10/100	RMII/Rev-RMII(Optional)	v
AX88772A	High (2.0)	-	10/100	-	v
AX88172A	High (2.0)	-	10/100	(Rev-)MII/Rev-RMII	v
AX88772	High (2.0)	-	10/100	MII	-

Part No.	IP/TCP/UDP Checksum	Wake-on-LAN	Serial Interface	Temperature Range (°C)	Package
AX88179	v	v	-	0 ~ +70	QFN-68
AX88178	-	v	-	0 ~ +70	LQFP-128
AX88760	-	v	-	0 ~ +70	LQFP-100
AX88772B	v	v	-	0 ~ +70/ -45 ~ +85	LQFP-64
AX88772A	-	v	I <sup>2</sup> C, SPI UART	0 ~ +70	LQFP-64
AX88172A	-	v	I <sup>2</sup> C, SPI UART	0 ~ +70	TQFP-80
AX88772	-	v	-	0 ~ +70	LQFP-128

Figure 6. Selection Guide



## 4. Ordering Information

The following are the ordering information of AX88772B silicon and AX88772B demo boards. Please contact ASIX's Sales ([sales@asix.com.tw](mailto:sales@asix.com.tw)) for more details.

Part Number	Description
<b>AX88772BLF</b>	64 PIN, LQFP Package, Commercial grade 0°C to +70 °C (Green, Lead-Free)
<b>AX88772BLI</b>	64 PIN, LQFP Package, Industrial grade -40°C to +85 °C (Green, Lead-Free)

AX88772B Demo Boards	Description
AX88772B USB to 100Base-TX Ethernet Demo Board	This is a USB dongle for AX88772B USB to 100Base-TX Ethernet application
AX88772B USB to 100Base-TX Ethernet (with RMII) Demo Board	This is a general-purpose demo board for AX88772B USB to 100Base-TX Ethernet (with optional RMII/Rev-RMII interface) application
AX88772B USB to 100Base-FX 1x9 SC Ethernet Demo Board	This is a general-purpose demo board for AX88772B USB to 100Base-FX 1x9 SC Fiber Ethernet (with optional RMII/Rev-RMII interface) application
AX88772B USB to 100Base-FX POF Ethernet Demo Board	This is a general-purpose demo board for AX88772B USB to 100Base-FX POF (Plastic Optical Fiber) Fiber Ethernet (with optional RMII/Rev-RMII interface) application

Figure 7. Ordering Information

## 5. Target Applications

The following are some PC/Internet and consumer electronics target applications for your reference.



Figure 8. Target Applications

## 6. Mass Production Solutions

To support the mass production for those products using AX88772B chips. ASIX provides the Windows SROM Programming Tool and Windows Production Test Tool solutions for AX88772B customers. This chapter provides a brief introduction for both solutions. Please refer to “AX88772B EEPROM User Guide” for details.

### 6-1. Windows SROM Programming Tool

ASIX Electronics provides a Windows SROM Programming tool for users to easily program the Serial EEPROM of AX88772B on a typical Windows 7/Vista/XP/2000 PC. This AX88772B Windows SROM Programming Tool supports to customize the MAC address, Serial Number, Vendor ID and Product ID, etc. for AX88772B based application systems in mass production.

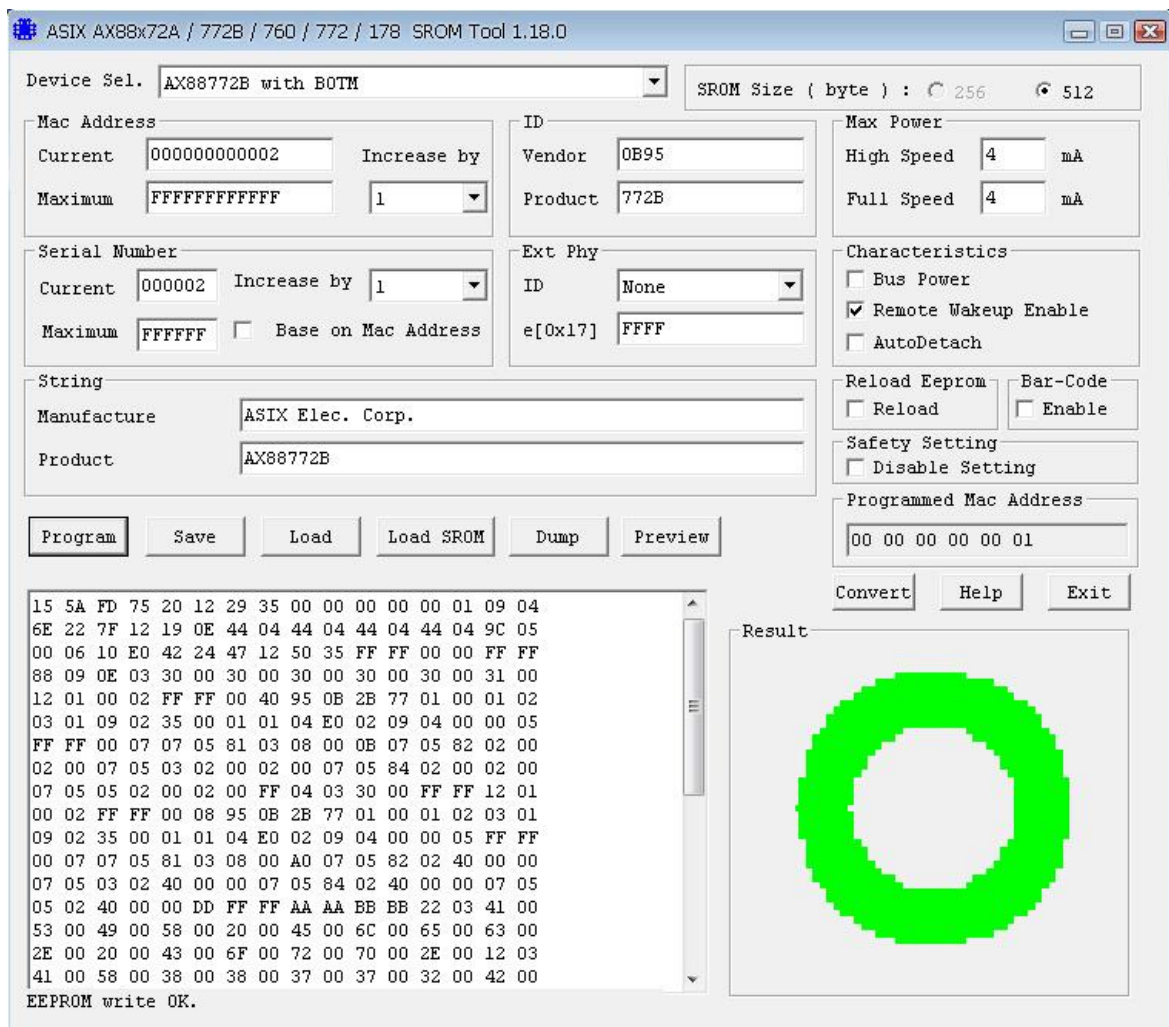

Figure 9. Windows SROM Programming Tool

## 6-2. Windows Production Test Tool

ASIX Electronics provides a Windows Production Test tool for users to run some basic network function tests and program the EEPROM of their AX88772B based application systems during production. This tool is used for testing the USB to Ethernet Network Adapter product that uses ASIX AX88772B chip.

This tool supports to send/receive packets in different Ethernet speed modes, and program EEPROM. This tool can be run on a Windows 7/Vista/XP/2000 PC, which installs the special AX88772B Windows test driver. This tool also needs a separate server PC to run the test server tool. The test server tool on server PC can receive packets from the “device under test” product, and then reply back.

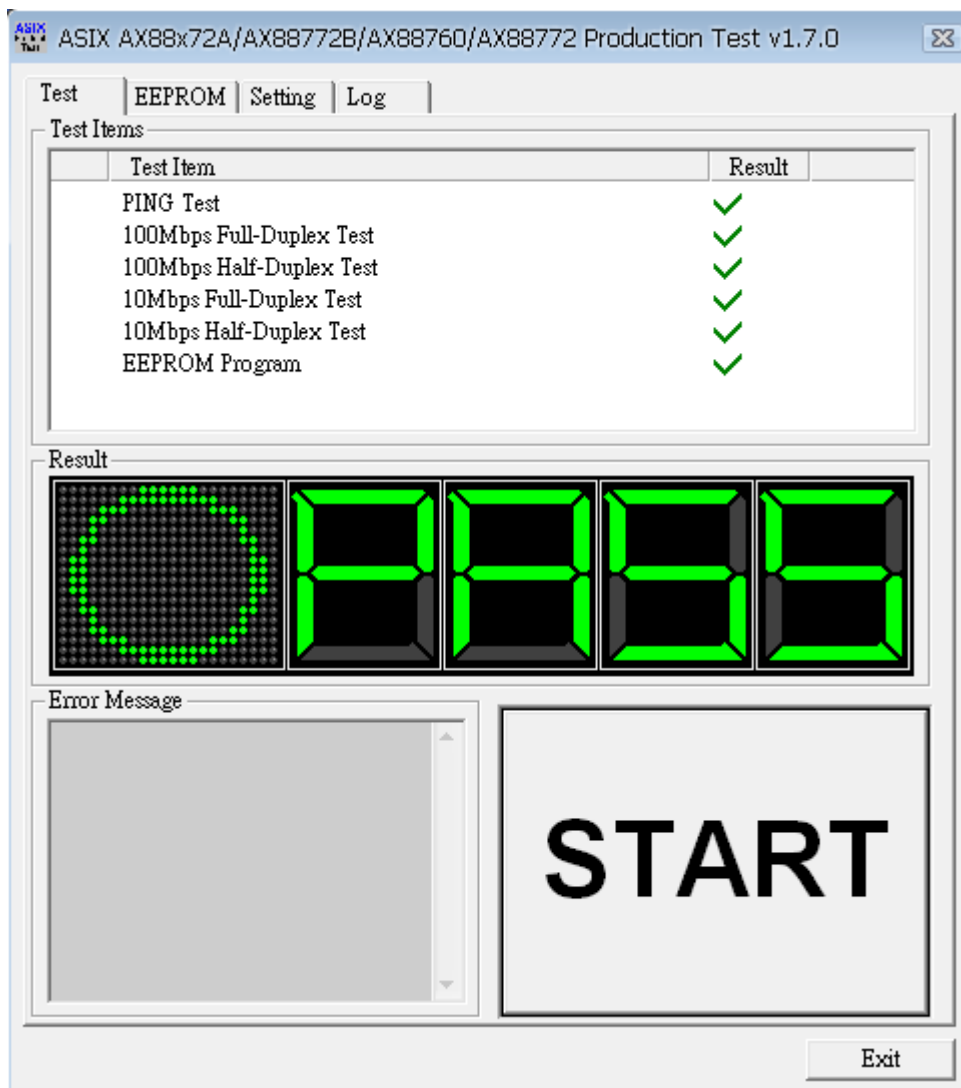

Figure 10. Windows Production Test Tool

### 7. AX88772B Demo Boards

ASIX Electronics provides several AX88772B demo boards for users to evaluate the basic functions of AX88772B on different target applications. If you need to purchase the AX88772B demo boards, please contact ASIX's Sales ([sales@asix.com.tw](mailto:sales@asix.com.tw)) for more details.

#### 7-1. AX88772B USB to 100Base-TX Ethernet Demo Board

The following is the picture of AX88772B USB to 100Base-TX Ethernet demo board for your reference.

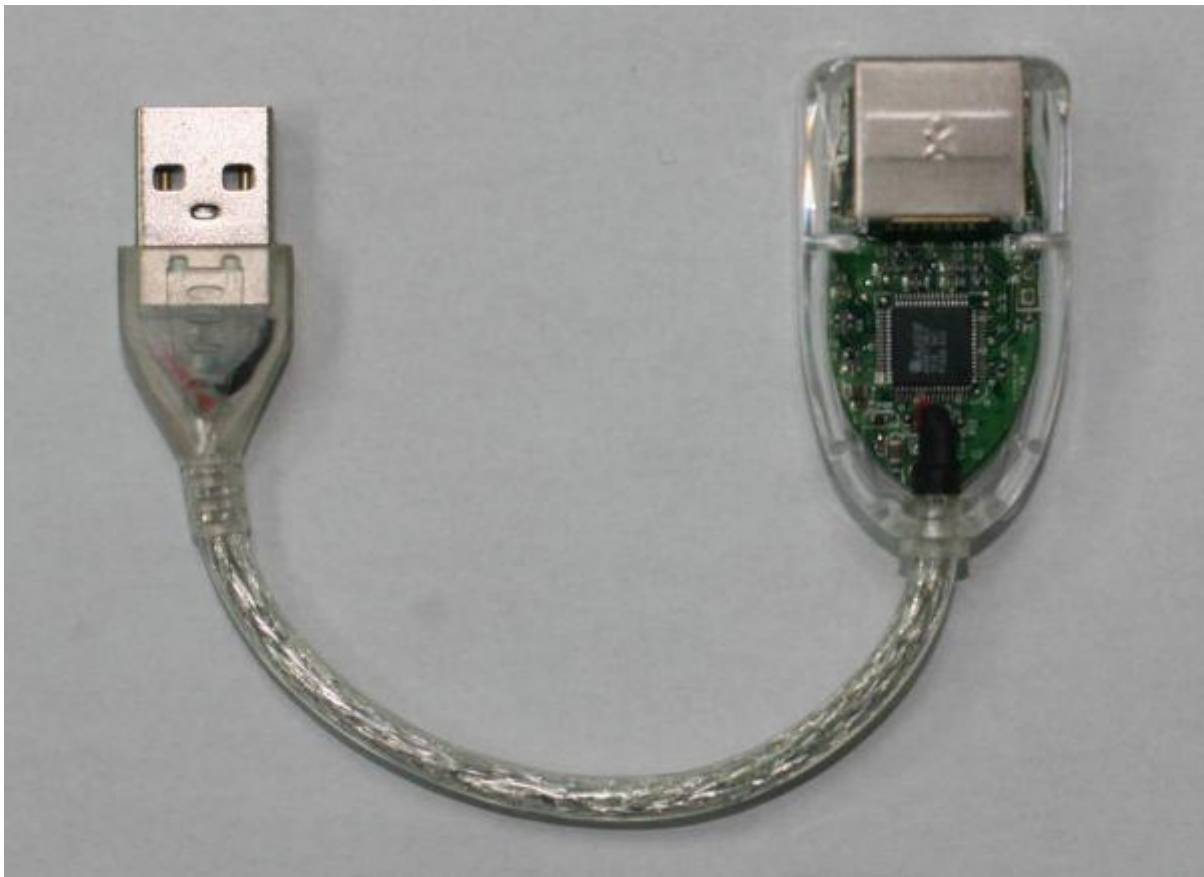

Figure 11. AX88772B USB to 100Base-TX Ethernet Demo Board

### 7-2. AX88772B USB to 100Base-TX Ethernet (with RMI) Demo Board

The following is the picture of AX88772B USB to 100Base-TX Ethernet (with RMI) demo board for your reference.

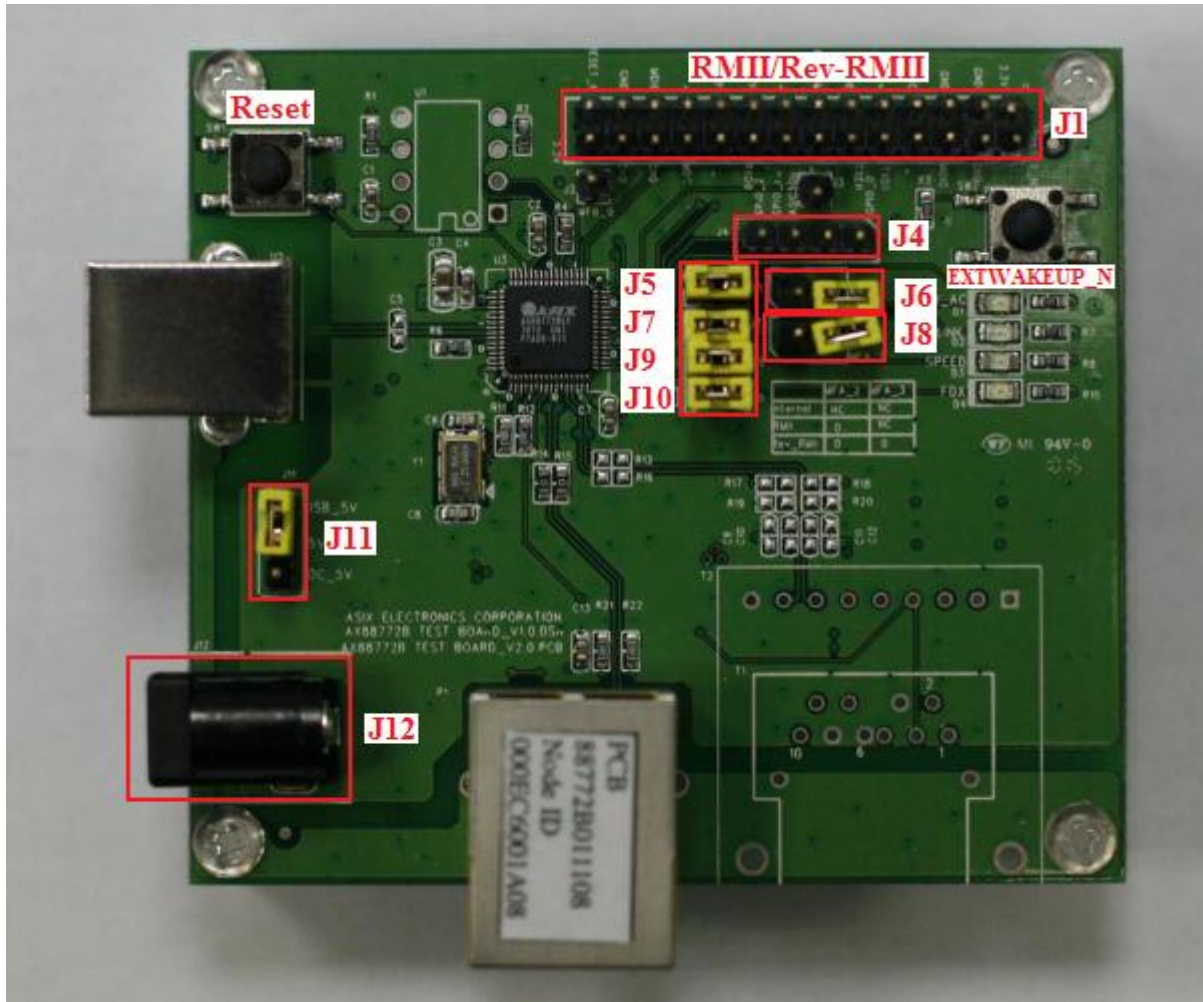

Figure 12. AX88772B USB to 100Base-TX Ethernet (with RMI) Demo Board

### 7-3. AX88772B USB to 100Base-FX 1x9 SC Ethernet Demo Board

The following is the picture of AX88772B USB to 100Base-FX 1x9 SC Ethernet demo board for your reference.

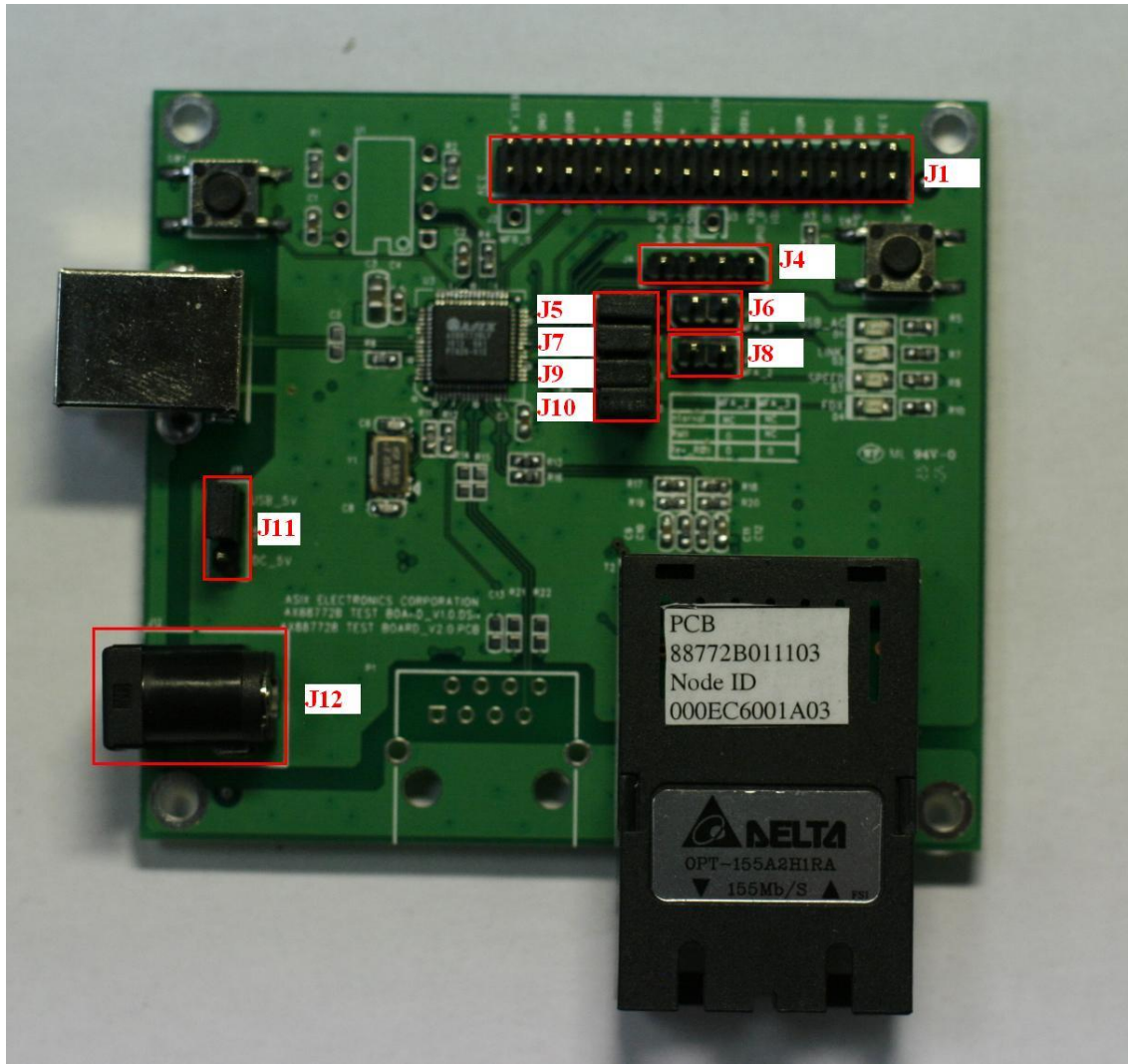

Figure 13. AX88772B USB to 100Base-FX 1x9 SC Ethernet Demo Board

## 7-4. AX88772B USB to 100Base-FX POF Ethernet Demo Board

The following is the picture of AX88772B USB to 100Base-FX POF Ethernet demo board for your reference.

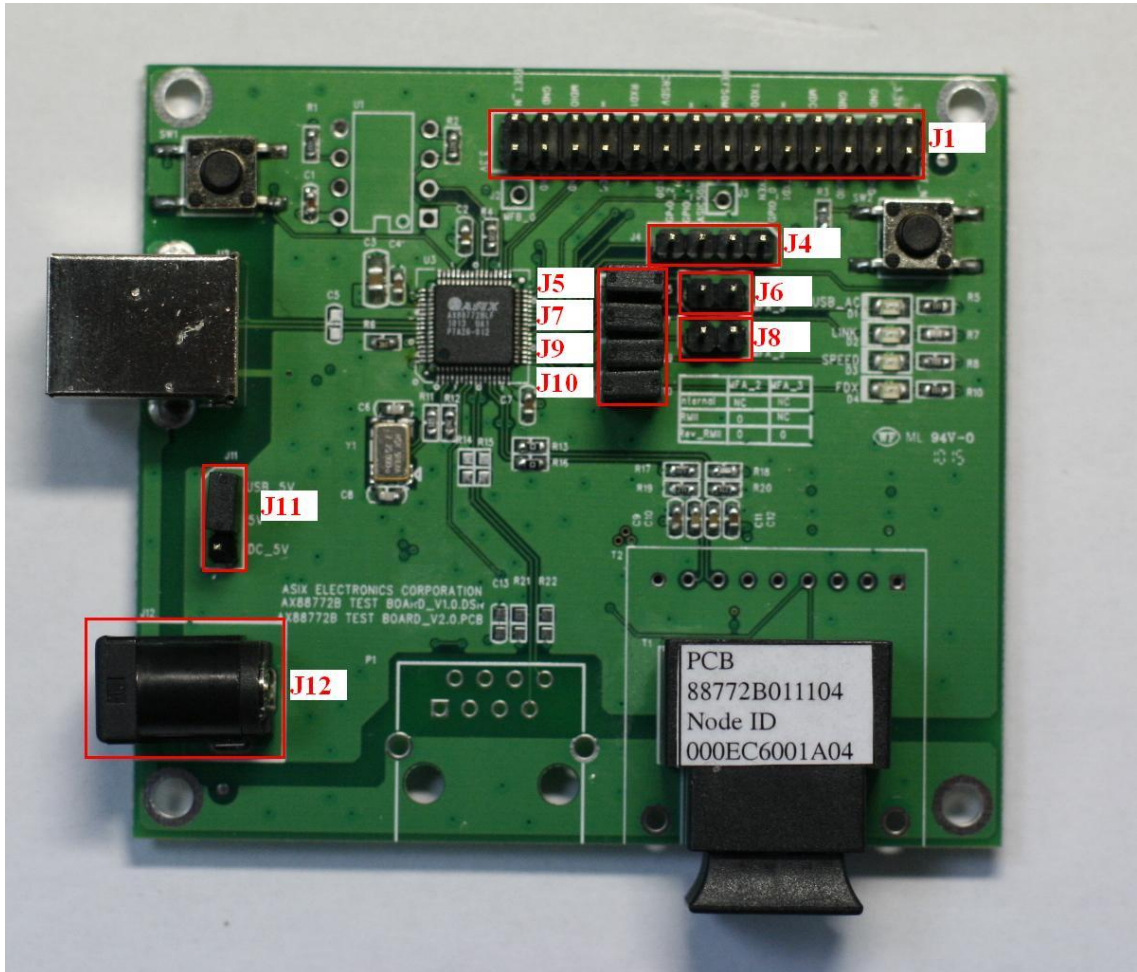

Figure 14. AX88772B USB to 100Base-FX POF Ethernet Demo Board



The following is the jumper configuration table of the AX88772B USB to 100Base-TX/FX Ethernet (with RMI) demo boards.





















Jumper	Setting	Description
J1		The J1 is the RMI/Reverse-RMI interface headers. Please refer to AX88772B USB to 100Base-TX/FX Ethernet (with RMI) Demo Boards Reference Schematic for details.
J4	<b>J4</b>  <b>1 2 3 4</b> Pole #1: GPIO2 Pole #2: VCC 3.3V Pole #3: GPIO1 Pole #4:GPIO0/PME	AX88772B GPIO Pins
J6/J8	<b>J6</b>  <b>J8</b>  (Default)	Set AX88772B to Internal Ethernet PHY
	<b>J6</b>  <b>J8</b> 	Set AX88772B to RMI mode
	<b>J6</b>  <b>J8</b> 	Reserved
	<b>J6</b>  <b>J8</b> 	Set AX88772B to Reverse-RMI mode
J5/J7/J9/J10	<b>J5</b>  <b>J7</b>  <b>J9</b>  <b>J10</b>  J5 : PHY_N J7 : RMI_N J9 : MDIO J10 : MDC	The multi-function pins (PHY_N, RMI_N, MDIO, MDC) for RMI/Reverse-RMI pins.
	<b>J5</b>  <b>J7</b>  <b>J9</b>  <b>J10</b>  (Default) J5 : MFA3 J7 : MFA2 J9 : MFA1 J10 : MFA0	The multi-function pins (MFA0 ~ MFA3) for LED display purpose. Please refer to PIN configuration of MFA in section 2.2 of AX88772B datasheet for details.
J11/J12	<b>J11</b>  <b>1 2 3</b> (Default) Pole #1: USB_5V Pole #2: 5V Pole #3: DC_5V	Set AX88772B USB to 100Base-TX/FX Ethernet (with RMI) demo boards to Bus-power mode. The J12 connector doesn't need to be connected.
	<b>J11</b>  <b>1 2 3</b>	Set AX88772B USB to 100Base-TX/FX Ethernet (with RMI) demo boards to Self-power mode. The J12 connector should be connected to a 5V power adapter.

Figure 15. AX88772B USB to 100Base-TX/FX Ethernet with RMI Demo Boards Jumper Setting Table

## 8. Related Technical Archives

The following is the AX88772B product web page for your reference. You can download some basic AX88772B related technical archives from this AX88772B product web page.

### AX88772B – Low-pin-count USB 2.0 to 10/100M Fast Ethernet controller

(<http://www.asix.com.tw/products.php?op=plItemdetail&PItemID=105;65;86&PLine=65>)

AX88772B Technical Archives	Type	Availability*
AX88772B Product Introduction	Document	This document
AX88772B Product Brief	Document	Public Release
AX88772B USB to 100Base-TX Ethernet Demo Board Reference Schematic	Schematic	Public Release
AX88772B USB to 100Base-TX/FX Ethernet with RMII Demo Boards Reference Schematic	Schematic	Public Release
AX88772B Windows 8 64-bit In-box Driver	Driver	Windows 8 In-box Driver
AX88772B Windows 8 32-bit In-box Driver	Driver	Windows 8 In-box Driver
AX88772B Windows 7 64-bit Driver	Driver	Public Release
AX88772B Windows 7 32-bit Driver	Driver	Public Release
AX88772B Windows Vista 64-bit Driver	Driver	Public Release
AX88772B Windows Vista 32-bit Driver	Driver	Public Release
AX88772B Windows XP 64-bit Driver	Driver	Public Release
AX88772B Windows XP 32-bit Driver	Driver	Public Release
AX88772B Android/Linux Driver	Driver	Public Release
AX88772B WinCE 7.0 Driver	Driver	Public Release
AX88772B WinCE 6.0 Driver	Driver	Public Release
AX88772B WinCE 5.0/Mobile 5/Mobile 6 Driver	Driver	Public Release
AX88772B Apple Mac OSX 10.4 to 10.7 Drivers	Driver	Public Release
AX88772B Datasheet	Document	MyASIX Membership
AX88772B USB-to-LAN Application Design Guide	Document	MyASIX Membership
AX88772B USB to 100Base-TX Ethernet Demo Board PCB file	PCB	MyASIX Membership
AX88772B USB to 100Base-TX/FX Ethernet with RMII Demo Boards PCB file	PCB	MyASIX Membership
AX88772B USB to 100Base-TX Ethernet Demo Board Gerber files	Gerber	MyASIX Membership
AX88772B USB to 100Base-TX/FX Ethernet with RMII Demo Boards Gerber files	Gerber	MyASIX Membership
AX88772B USB to 100Base-TX Ethernet Demo Board BOM File	BOM	MyASIX Membership
AX88772B USB to 100Base-TX Ethernet with RMII Demo Board BOM file	BOM	MyASIX Membership
AX88772B USB to 100Base-FX 1x9 SC Ethernet Demo Board BOM file	BOM	MyASIX Membership
AX88772B USB to 100Base-FX POF Ethernet Demo Board BOM file	BOM	MyASIX Membership

AX88772B IBIS Model	IBIS	MyASIX Membership
AX88772B Reliability Report	Report	MyASIX Membership
AX88772B EEPROM/Manufacture User Guide	Document	Contact ASIX Sales
AX88772B Windows SROM Programming Tool	Utility	Contact ASIX Sales
AX88772B Windows Production Test Tool	Utility	Contact ASIX Sales
AX88772B Linux SROM Programming Tool	Utility	Contact ASIX Sales
AX88772B WinCE SROM Programming Tool	Utility	Contact ASIX Sales
AX88772B Windows IEEE 802.3 Compliant Test Tool	Utility	Contact ASIX Sales
AX88772B Performance Test Report	Report	Contact ASIX Sales
AX88772B RoHS Report	Report	Contact ASIX Sales
AX88772B USB-IF Compliant Test Report	Report	Contact ASIX Sales
AX88772B IEEE 802.3 Compliant Test Reports	Report	Contact ASIX Sales

Figure 16. Related Technical Archives

Availability Type	Description
Public Release	Please download the technical archives from <a href="#">AX88772B product web page</a> directly.
MyASIX Membership	Please register MyASIX membership from MyASIX register web page ( <a href="http://www.asix.com.tw/RegLogin.php?mod=thisis">http://www.asix.com.tw/RegLogin.php?mod=thisis</a> ) first and then download the technical archives from <a href="#">AX88772B product web page</a> .
Contact ASIX Sales	Please contact ASIX's Sales ( <a href="mailto:sales@asix.com.tw">sales@asix.com.tw</a> ) for more details.

Figure 17. Technical Archives Availability Type



**4F, No.8, Hsin Ann Rd., Hsinchu Science Park,  
Hsinchu, Taiwan, R.O.C.**

**TEL: +886-3-5799500**

**FAX: +886-3-5799558**

**Email: [support@asix.com.tw](mailto:support@asix.com.tw)**

**Web: <http://www.asix.com.tw>**