

Uni- and Bipolar Hall IC Switches for Magnetic Field Applications

TLE 4905 L; TLE 4935 L
TLE 4935-2 L; TLE 4945 L

Bipolar IC

Features

- Temperature compensated magnetic performance
- Digital output signal
- For unipolar and alternating magnetic fields
- Large temperature range
- Protection against reversed polarity
- Output protection against electrical disturbances

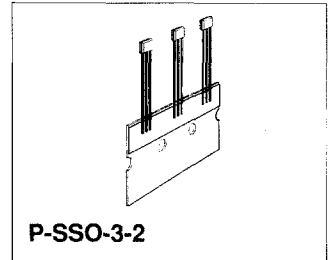

Type	Ordering Code	Package
TLE 4905 L	Q67006-A9120	P-SSO-3-2
TLE 4935 L	Q67006-A9112	P-SSO-3-2
TLE 4935-2 L	Q67006-A9143	P-SSO-3-2
TLE 4945 L	Q67006-A9163	P-SSO-3-2

TLE 4905/35/35-2/45 L (Unipolar/Bipolar Magnetic Field Switches) have been designed specifically for automotive and industrial applications. Reverse polarity protection is included on-chip as is output protection against negative voltage transients.

Typical applications are position/proximity indicators, brushless DC motor commutation, rotational indexing etc.

Pin Configuration

(view on branded side of component)

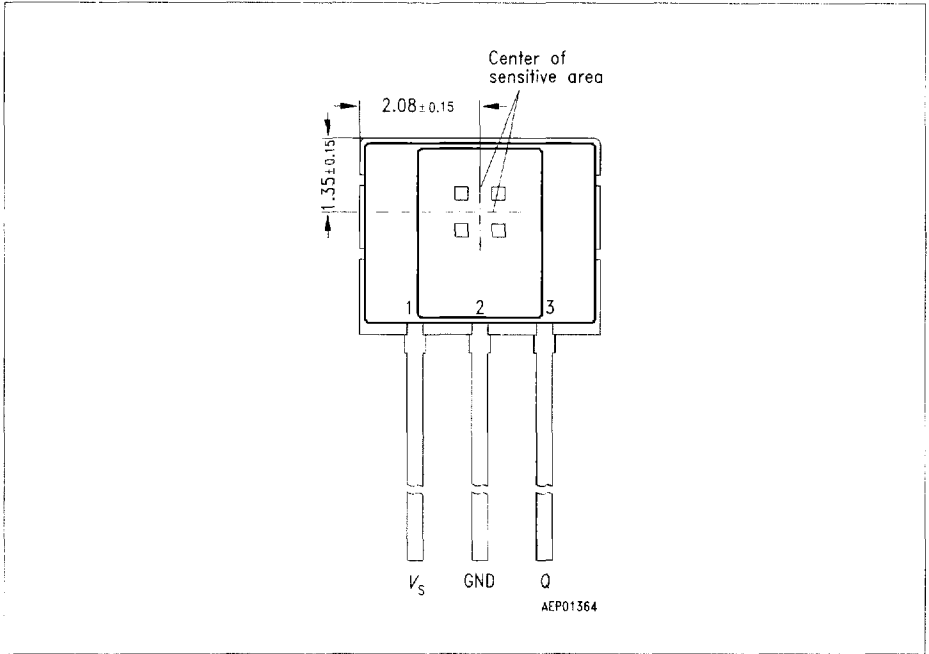

Pin Definitions and Functions

Pin No.	Symbol	Function
1	V_S	Supply voltage
2	GND	Ground
3	Q	Output

Circuit Description

The circuit includes Hall generator, amplifier and Schmitt-Trigger on one chip. The internal reference provides the supply voltage for the components. A magnetic field perpendicular to the chip surface induces a voltage at the hall probe. This voltage is amplified and switches a Schmitt-trigger with open-collector output. A protection diode against reverse power supply is integrated. The output is protected against electrical disturbances.

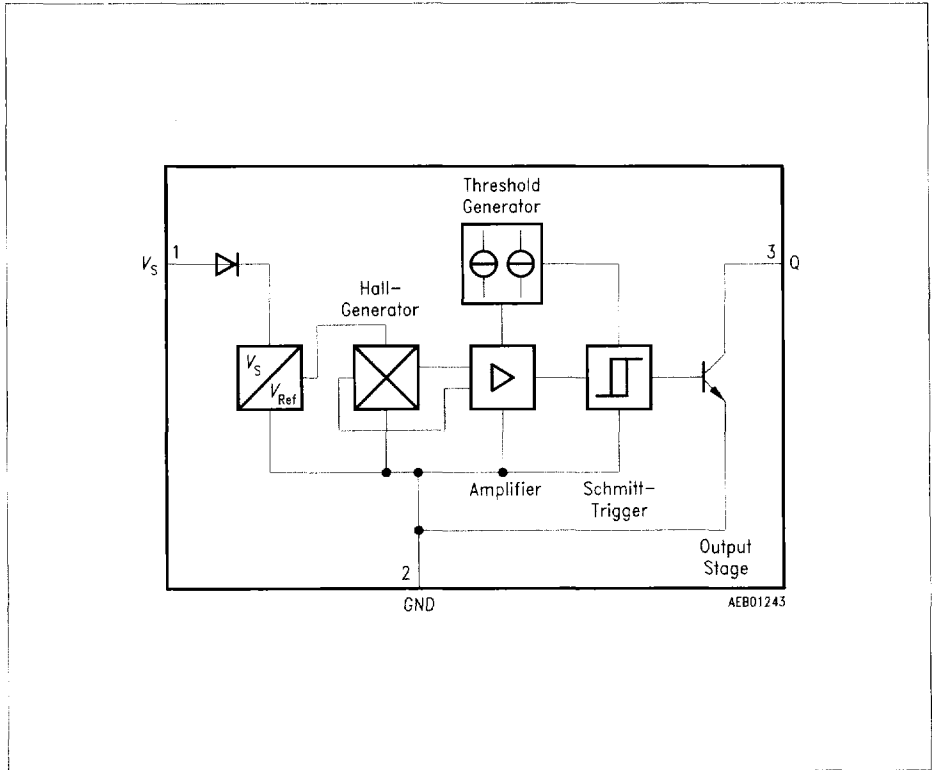

**Figure 78
Block Diagram**

Functional Description Unipolar Type TLE 4905 (figure 79 and 80)

When a positive magnetic field is applied in the indicated direction (**figure 79**) and the turn-on magnetic induction B_{OP} is exceeded, the output of the Hall-effect IC will conduct (Operate Point). When the current is reduced, the output of the IC turns off (Release Point; **figure 80**).

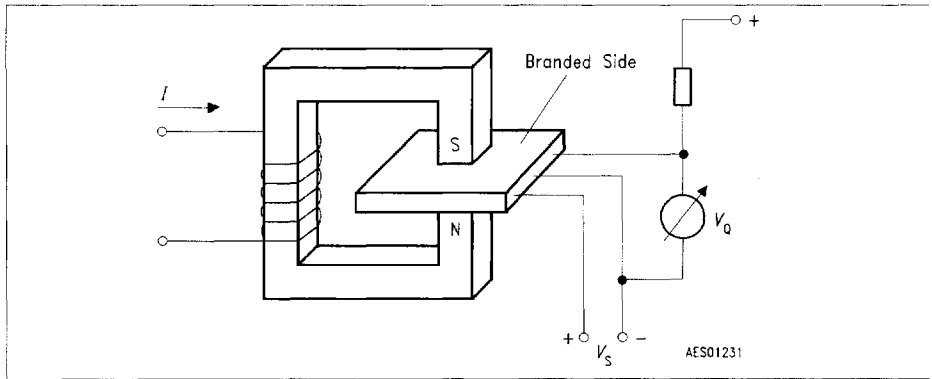

Figure 79
Sensor/Magnetic-Field Configuration

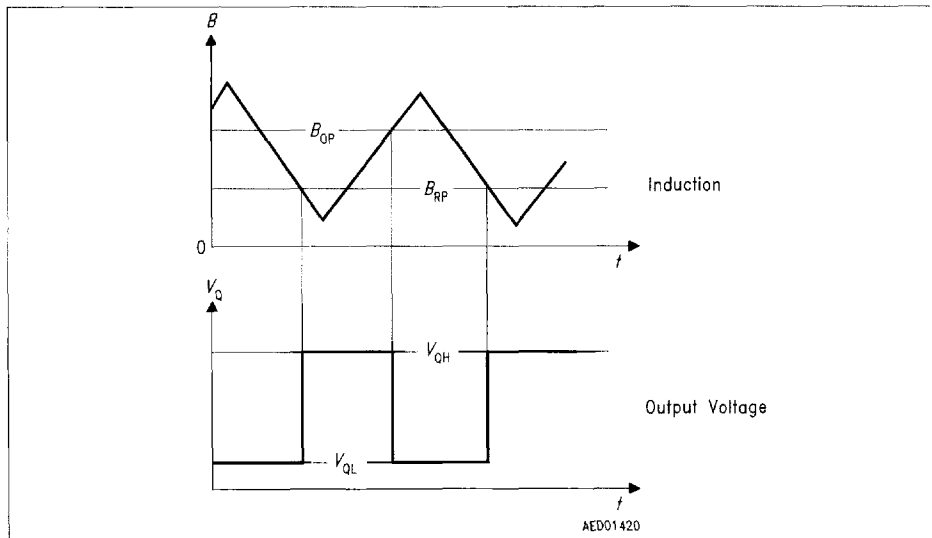

Figure 80
Switching Characteristics Unipolar Type

Functional Description Bipolar Type TLE 4935/35-2/45 (figure 81 and 82)

When a positive magnetic field is applied in the indicated direction (**figure 81**) and the turn-on magnetic induction B_{OP} is exceeded, the output of the Hall-effect IC will conduct (Operate Point). When a reverse magnetic field is generated, the output of the IC turns off (Release Point; **figure 82**).

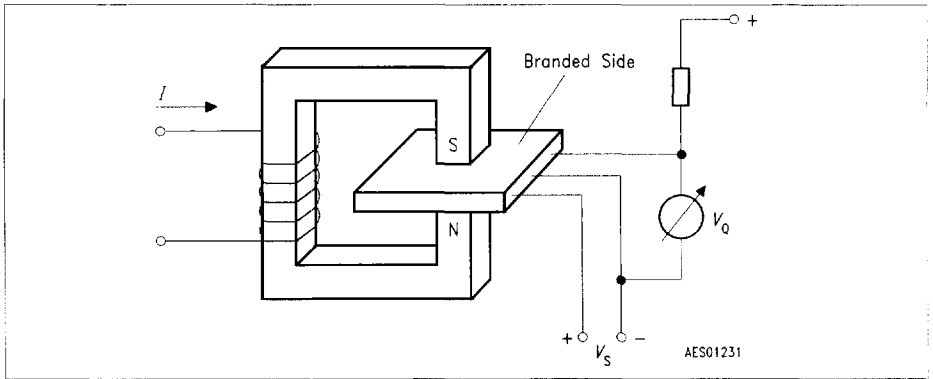

Figure 81
Sensor/Magnetic-Field Configuration

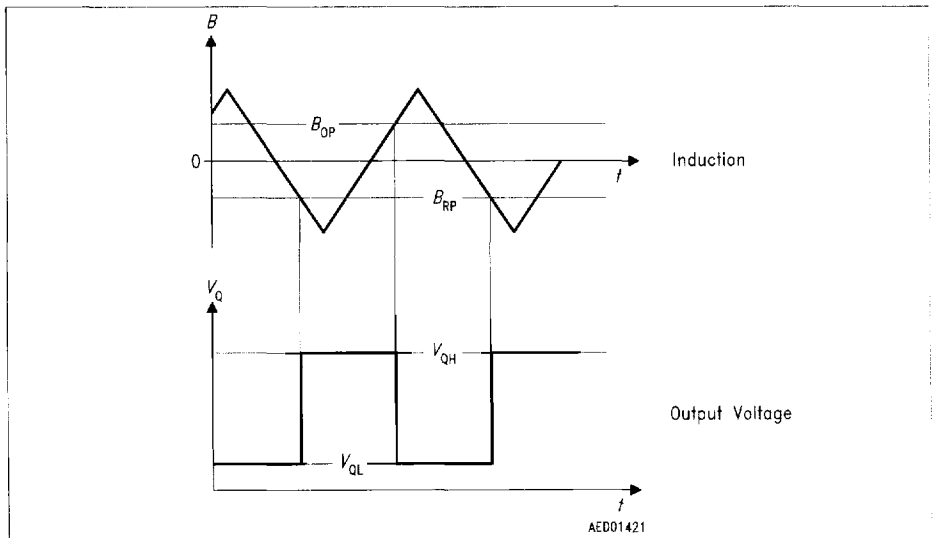

Figure 82
Switching Characteristics Bipolar Type

Absolute Maximum Ratings

$T_j = -40$ to 150 °C

Parameter	Symbol	Limit Values		Unit	Remarks
		min.	max.		
Supply voltage	V_S	-40	32	V	–
Supply voltage	V_S	–	40	V	$t < 400$ ms; $v = 0.1$
Output voltage	V_O	–	32	V	–
Output current	I_O	–	100	mA	–
Output reverse current	$-I_O$	–	100	mA	–
Junction temperature	T_j	-40	150	°C	–
Junction temperature	T_j	–	170	°C	1000 h
Junction temperature	T_j	–	210	°C	40 h
Storage temperature	T_{stg}	-50	150	°C	–
Thermal resistance	$R_{th,JA}$	–	190	K/W	–

Note: Stresses above those listed here may cause permanent damage to the device. Exposure to absolute maximum rating conditions for extended periods may affect device reliability.

Operating Range

Parameter	Symbol	Limit Values		Unit	Remarks
		min.	max.		
Supply voltage	V_S	3.8	24	V	–
Junction temperature	T_j	-40	150	°C	–
Junction temperature	T_j	-40	170	°C	thresholds may exceed the limits

Note: In the operating range the functions given in the circuit description are fulfilled.

AC/DC Characteristics

$3.8\text{ V} \leq V_S \leq 24\text{ V}$; $-40\text{ }^\circ\text{C} \leq T_j \leq 150\text{ }^\circ\text{C}$

Parameter	Symbol	Limit Values			Unit	Test Condition	Test Circuit
		min.	typ.	max.			
Supply current	$I_{S\text{High}}$	–	3	7	mA	$B < B_{RP}$	1
	$I_{S\text{Low}}$	–	4	8	mA	$B > B_{OP}$	1
Output saturation voltage	$V_{Q\text{Sat}}$	–	0.25	0.5	V	$I_Q = 40\text{ mA}$	1
Output leakage current	I_{OL}	–	–	10	μA	$V_Q = 24\text{ V}$	1
Rise/fall time	t_r / t_f	–	–	1	μs	$R_L = 1.2\text{ k}\Omega$ $C_L \leq 33\text{ pF}$	1

Note: The listed characteristics are ensured over the operating range of the integrated circuit. Typical characteristics specify mean values expected over the production spread. If not otherwise specified, typical characteristics apply at $T_j = 25\text{ }^\circ\text{C}$ and the given supply voltage.

Magnetic Characteristics

$3.8 \text{ V} \leq V_S \leq 24 \text{ V}$

Parameter	Symbol	Limit Values								Unit
		TLE 4905 unipolar		TLE 4935 bipolar latch		TLE 4935-2 bipolar latch		TLE 4945 bipolar latch		
		min.	max.	min.	max.	min.	max.	min.	max.	

Junction Temperature $T_J = -40 \text{ }^\circ\text{C}$

Turn-ON induction	B_{OP}	7.5	19	10	20	15	27	-6	10	mT
Turn-OFF induction	B_{RP}	5.5	17	-20	-10	-27	-15	-10	6	mT
Hysteresis ($B_{OP}-B_{RP}$)	ΔB_{HY}	2	6.5	20	40	30	54	2	10	mT

Junction Temperature $T_J = 25 \text{ }^\circ\text{C}$

Turn-ON induction	B_{OP}	7	18	10	18	14	26	-6	10	mT
Turn-OFF induction	B_{RP}	5	16	-18	-10	-26	-14	-10	6	mT
Hysteresis ($B_{OP}-B_{RP}$)	ΔB_{HY}	2	6	20	36	28	52	2	10	mT

Junction Temperature $T_J = 85 \text{ }^\circ\text{C}$

Turn-ON induction	B_{OP}	6.5	17.5	9	18	13	26	-6	10	mT
Turn-OFF induction	B_{RP}	4.5	15	-18	-9	-26	-13	-10	6	mT
Hysteresis ($B_{OP}-B_{RP}$)	ΔB_{HY}	2	5.5	18	36	26	52	2	10	mT

Magnetic Characteristics (cont'd)

$3.8\text{ V} \leq V_s \leq 24\text{ V}$

Parameter	Symbol	Limit Values								Unit
		TLE 4905 unipolar		TLE 4935 bipolar latch		TLE 4935-2 bipolar latch		TLE 4945 bipolar latch		
		min.	max.	min.	max.	min.	max.	min.	max.	

Junction Temperature $T_j = 150\text{ }^\circ\text{C}$

Turn-ON induction	B_{OP}	6	17	7	18	12	25	-6	10	mT
Turn-OFF induction	B_{RP}	4	14	-18	-7	-25	-12	-10	6	mT
Hysteresis ($B_{OP}-B_{RP}$)	ΔB_{HY}	2	5	14	36	24	50	2	10	mT

Note: The listed characteristics are ensured over the operating range of the integrated circuit. Typical characteristics specify mean values expected over the production spread. If not otherwise specified, typical characteristics apply at $T_j = 25\text{ }^\circ\text{C}$ and the given supply voltage.

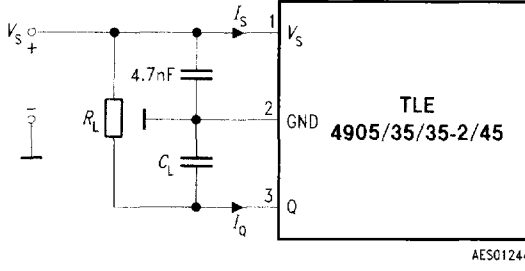

AES01244

Unipolar Type TLE 4905

Bipolar Type TLE 4935

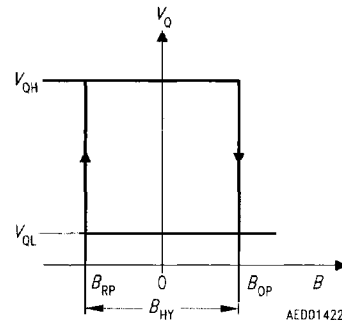
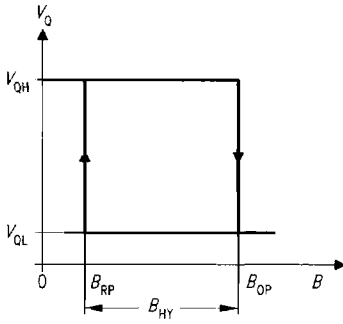

AED01422

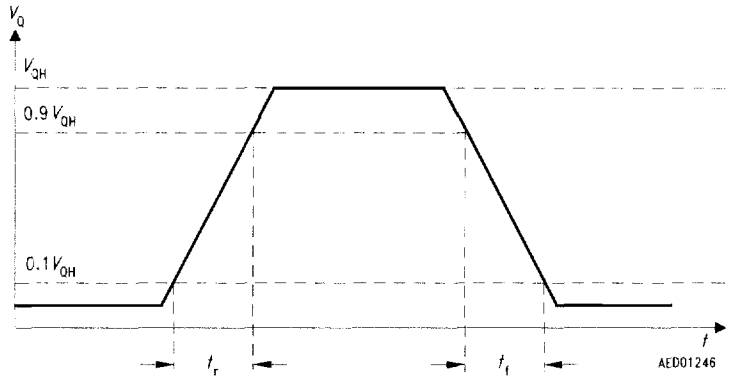

AED01246

**Figure 83
Test Circuit 1**

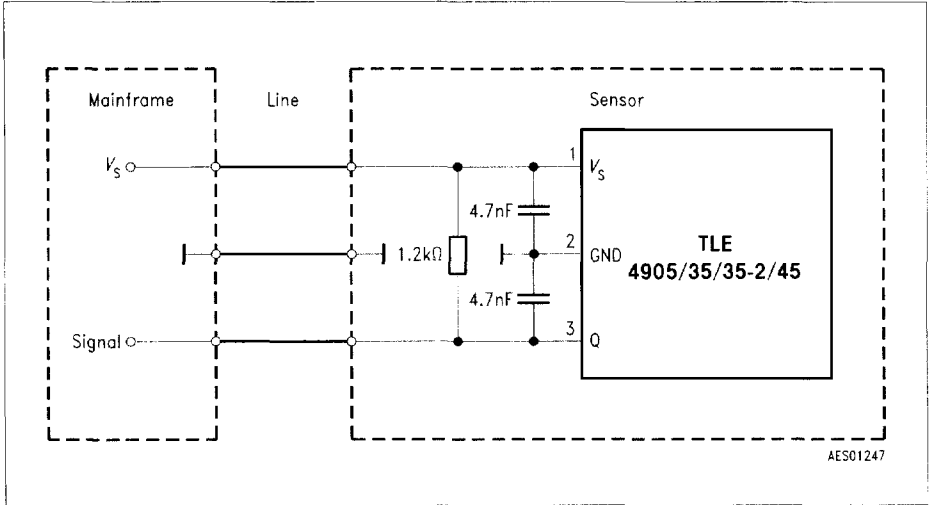
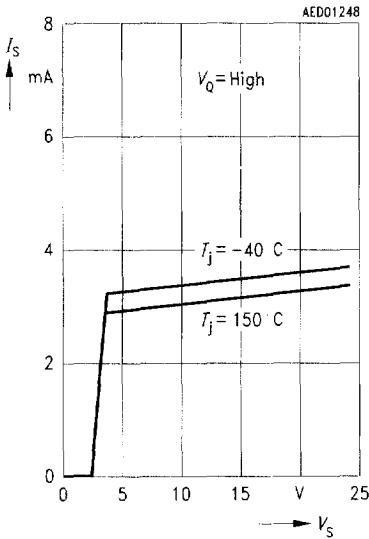
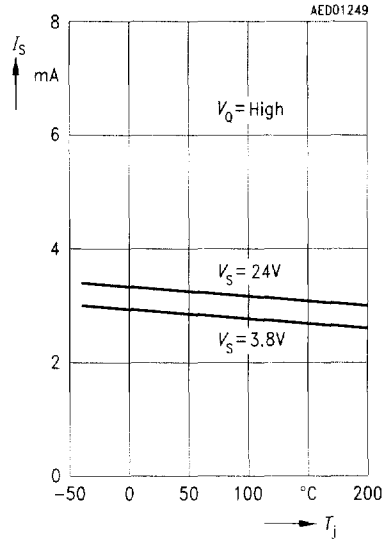

Figure 84
Application Circuit

Quiescent Current versus Supply Voltage



Quiescent Current versus Junction Temperature



Quiescent Current Difference versus Temperature

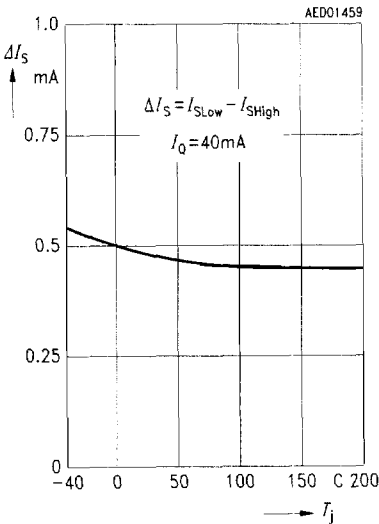

Saturation Voltage versus Output Current

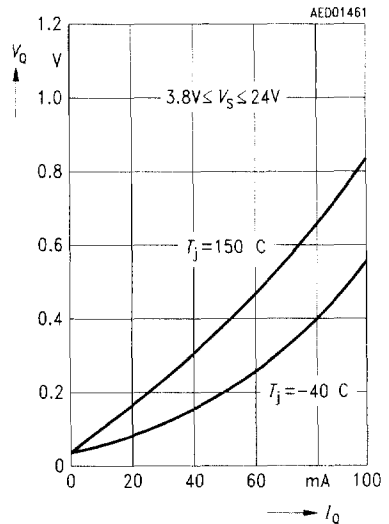

**TLE 4905 Operate-and Release-Point
versus Junction Temperature**

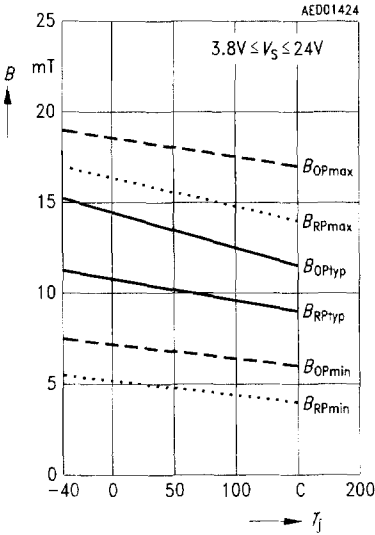

TLE 4905 Hysteresis versus Junction Temperature

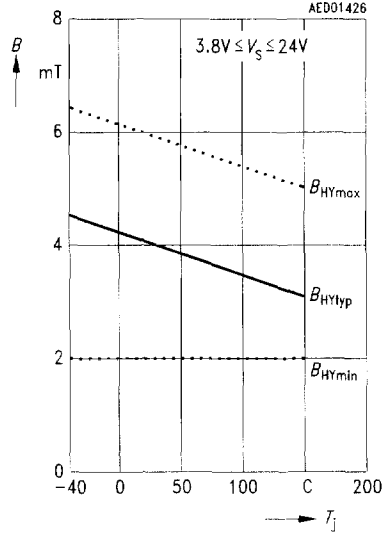

**TLE 4935 Operate-and Release-Point
versus Junction Temperature**

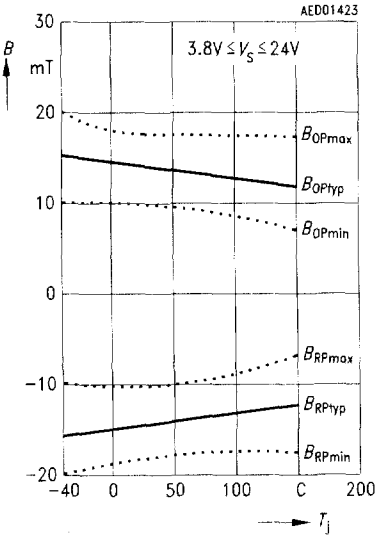

**TLE 4935-2 Operate-and Release-Point
versus Junction Temperature**

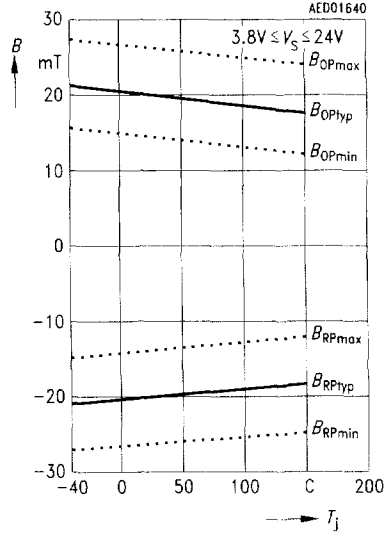

TLE 4945 Operate-and Release-Point
versus Junction Temperature

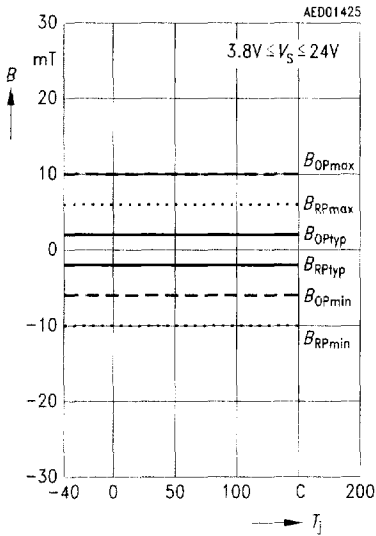

Package Outline

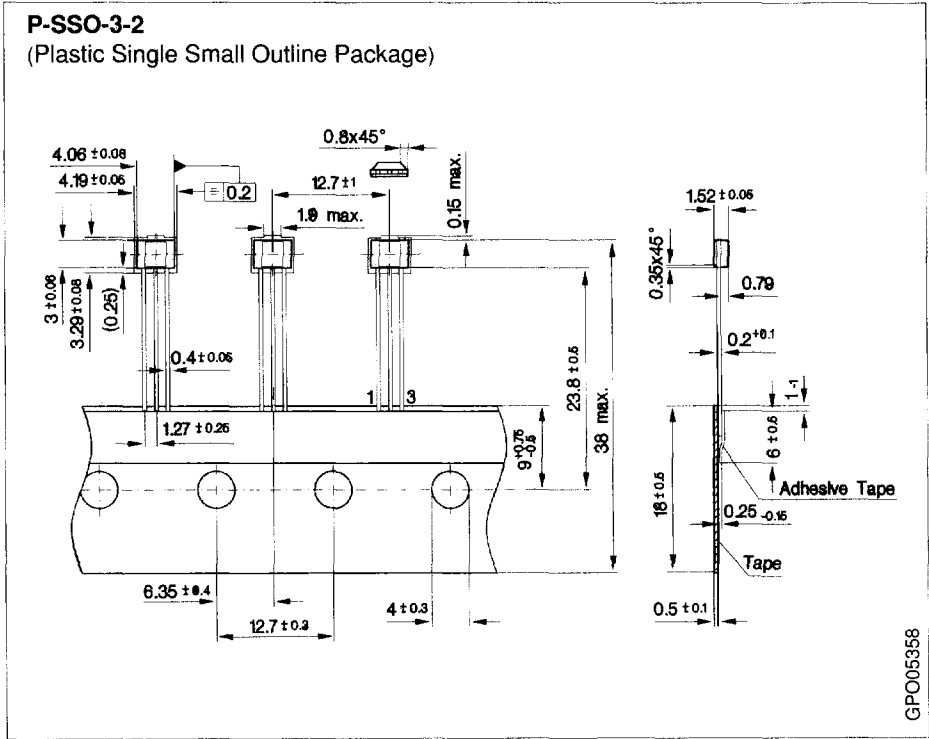

Exterior Packaging

I.e. tubes, trays, boxes are shown in our Data Book "Package Information". Dimensions in mm