



RN-WIFLY-SRL-UM

WiFly Serial Adapter

© 2011 Roving Networks. All rights reserved.
RN-WIFLY-SRL-UM-1.0 Version 1.0 11/11/2011

USER MANUAL

OVERVIEW

The Roving Networks Wi-Fi serial adapters supply a serial-to-Wi-Fi bridge, providing wireless connectivity to any legacy system that supports serial communication. Connected to a remote host, the adapters transfer data read or written to the serial interface to a remote application such as an iPhone app, data logger, or PC control console. The adapters support Wi-Fi infrastructures or ad hoc networking, which allows you to use existing, low-cost wireless connectivity while remotely connecting to any WiFly serial adapter in the world.

Because Apple iOS devices require an additional Bluetooth authorization co-processor for any and all devices connecting to the iPhone, using the Wi-Fi serial adapter in ad hoc mode is a simple, cost-effective way to connect to iPhone apps. The WiFly serial adapters are more than a cable replacement solution: by allowing TCP/IP sockets, applications can control and monitor hundreds of Wi-Fi serial adapters remotely distributed across a building LAN or campus WAN.

The adapters also support other usage modes. For example, when configured in auto-connect mode, the WiFly serial adapter connects to a pre-stored IP address whenever data is written to the serial port. The adapter can also be programmed to sleep automatically when idle and wake up based on a time delay, UART RX data, or CTS signal state change.

POWERING THE WIFLY SERIAL ADAPTER

The RN-340 and RN-370 serial adapters have different powering capabilities: the RN-340 uses a DC power source, while the RN-370 uses either batteries or a DC power source.

Powering the RN-340 Adapter

The RN-340 adapter has a built-in voltage regulator and can be powered from a 4 to 12 V DC power source. You can also power the RN-340 adapter using pin 9 of a DB9 connector.

Powering the RN-370 Adapter

You can power the RN-370 adapter using rechargeable batteries or the external power connector. The adapter has a red button on its top, which is a soft on/off switch.

WARNING: Do NOT use alkaline batteries when connecting the external power connector to the adapter; otherwise, the alkaline batteries will leak and damage the serial adapter.

Turning the Adapter On & Off

To turn the adapter on, press the red button for 1 second and then release it. The green, yellow, red, and blue LEDs flash in succession. After a moment, the blue and yellow LEDs go off and the red and green LEDs remain flashing.

To turn the adapter off, press the red button for 1 second and then release it. The green, yellow, red, and blue LEDs flash in succession several times. Then all LEDs turn off and the device is in sleep mode.

By default, the adapter automatically shuts off if it is not connected for more than 3 minutes (i.e., 180 seconds). You can control the sleep timer duration using the **set system sleep** <seconds> command. Use the **get sys** command to display the sleep timer's current settings.

Batteries & Charging

If you wish to power the module using AC power, insert rechargeable NiMH batteries into the device. When using the external power connector to charge the batteries, ensure that:

- You install rechargeable batteries before using the charger. Do not operate the adapter using the charger without batteries or the adapter will be permanently damaged.
- You only use the charger with NiMH batteries (NOT alkaline). Attempting to charge alkaline batteries causes battery acid to leak and destroys the adapter (and surrounding environment).
- The charge rate is low enough (< 100 ma) such that the batteries can be charged indefinitely without harm.
- The charger is a slow charger; it typically takes 10 hours to re-charge batteries fully from low battery.

You can apply external power from either the 5-V DC plug or pin 9 on the DB9 connector. The power plug is center pin positive, outer cylinder ground. The input MUST be 5-V DC for proper battery charging. Higher voltages can permanently damage the charger and battery.

You can view the current battery voltage in configuration mode using the **show bat** command. Note that with rechargeable NiMh batteries the voltage remains relatively unchanged just until they go dead.

STATUS LEDS

The adapters have green, red, and blue status LEDs (see Table 1). The blue LED blinks when data is sent or received on the serial interface; it does not indicate that the data was sent over the WiFi connection. If the blue LED is not flashing and your device is sending data to the serial port, you likely have a connection, incorrect baud rate, or hardware flow control (RTS/CTS) problem.

When using switch 1 to enable ad hoc mode, after power up all LEDs blink in succession from green to blue. This blinking does not occur when you set up ad hoc mode through software.

There is an additional red LED near the power connector that indicates external power is present at either the power plug or the DB9 connector.

Table 1. LED Indicators

State	Green LED	Red LED	Blue LED
On solid	Connected over TCP		
Fast blink	No IP address or configuration mode	Not associated	Rx/Tx data transfer
Slow blink	IP address OK	Associated, no Internet	
Off		Associated, Internet OK	

CONFIGURATION SWITCHES

The adapters have small configuration switches on the top. You need a paper clip or small screwdriver to flip them. Holding the adapter with the DB9 connector facing to the right, refer to Figure 1 for the switch numbering and on/off positions.

Figure 1. Switches

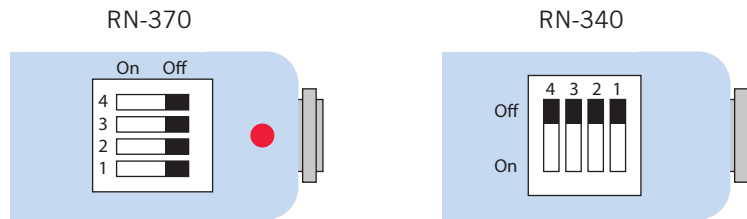

Switch 1 is used for ad hoc mode and for restoring factory defaults. With this switch turned on, the device powers up in ad hoc mode. The ad hoc network's SSID is Wifly-GSX-*NN* where *NN* is the last two digits of the adapter's MAC address.

To restore factory defaults, power on the device with switch 1 turned on, then toggle the switch five (5) times. If the adapter's file system has a configuration file named **user**, the adapter reads the data in this file as the default instead of using hardcoded defaults. If no user configuration file is present, the adapter uses the hardcoded factory defaults.

NOTE: You create the **user** configuration file with the **save user** command, which saves the current configuration settings.

Even if a user configuration file exists, you can override it's settings and restore the WiFly module to the factory hardcoded defaults by arming and toggling switch 1 seven (7) times. This bypass mechanism allows you to restore the adapter to its original settings if incorrect configuration is saved into the user file.

Switches 2 (sensor pin 2), 3 (sensor pin 3), and 4 (sensor pin 7) are currently unused.

CONFIGURATION

The WiFly module operates in two modes: data mode (default) and command mode. While in data mode, the WiFly module is essentially a data pipe. When the module receives data over a Wi-Fi, it strips the TCP/IP headers and trailers and passes the user data to the UART. When data is written to the UART, the module constructs the TCP/IP packet and sends it out over Wi-Fi. Thus, the entire process of sending/receiving data to the host is transparent to the end microprocessor. See Figure 2.

Figure 2. Data & Command Modes

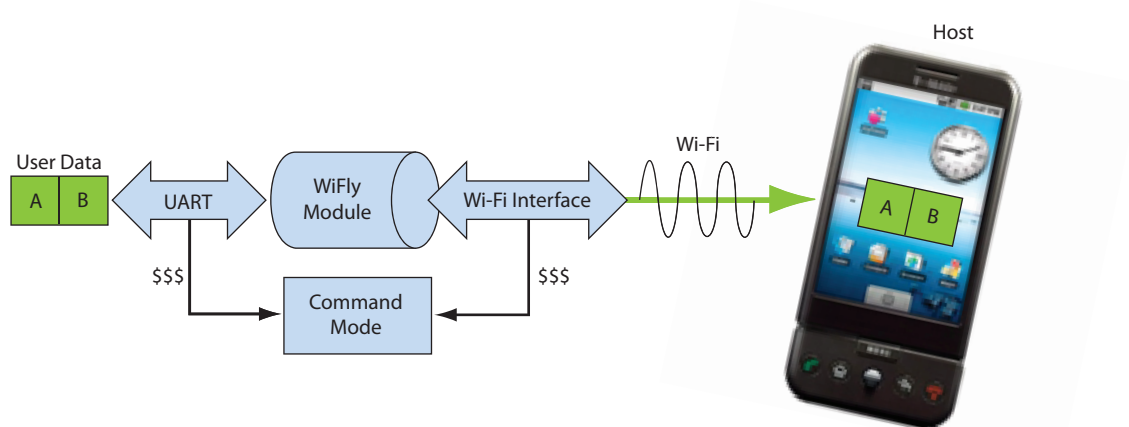

By default, the module is in data mode. Sending the escape sequence `$$$` causes the module to enter command mode. Once in command mode, you can configure the WiFly device using simple ASCII commands. To exit command mode and return to data mode, type `exit <cr>`.

Basic configuration only requires the wireless network access point's name (SSID) and authentication password. The WiFly module can only associate with one network at a time. Roving Networks recommends that you begin your evaluation by configuring the WiFly module using an open access point to simplify the setup.

There are two ways to configure the WiFly module:

- Over the UART, which is connected to a computer or microprocessor
- Via Wi-Fi using ad hoc networking

You need a terminal emulator to complete the setup.

NOTE: Roving Networks suggests using either the TeraTerm (Windows OS) or CoolTerm (Mac OS-X) terminal emulator program.

Configuration Using the RS-232 Serial Interface

You can configure the WiFly serial adapter by using a USB-to-serial cable or by plugging it directly into your computer's serial port. The following instructions describe how to use a terminal emulator to go into configuration mode, send commands to find networks, associate with an access point, and save your configuration.

Configure the Module Using a Terminal Emulator

To communicate with the module using a terminal emulator, perform the following steps:

1. Determine the COM port that was assigned to the USB-to-serial cable. If you do not know the COM port number, you can find it using the Windows Device Manager, which is in the system tools. In the Device Manager, browse and expand the selection for Ports (COM & LPT). In the example shown in Figure 3, the USB serial port is COM9. For OS-X, if you are using CoolTerm, you can view and select the port from within the application.
2. Open your terminal emulation program.
3. Specify the COM port. If you are using TeraTerm, select *Serial* and choose the COM port number from the *Port* drop-down list box.

NOTE: The default serial port setting for the WiFly module is 9600 baud, 8 bits, no parity, and 1 stop bit.

Figure 3. Finding the COM Port Number in Windows

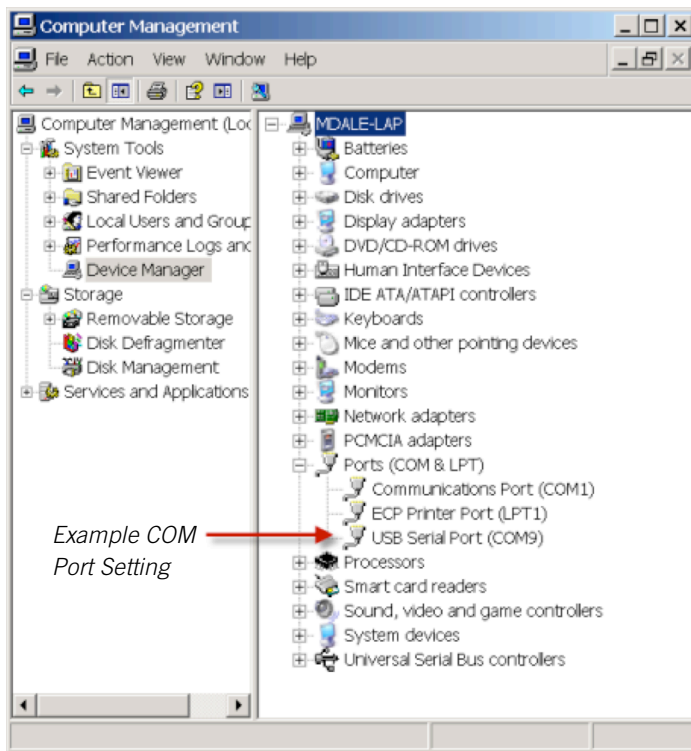

Enter Command Mode

To enter command mode, perform the following steps in the terminal emulator:

1. Type **\$\$\$**. You must type **\$\$\$** together quickly with no additional characters before or after them. The module replies with **CMD** to indicate it is in command mode.
2. Type **show net <cr>** to display the current network settings.

NOTE: When a command completes, the terminal displays a prompt in the format <X.XX> where X.XX indicates the module’s firmware version. In Figure 4, the version is 2.28.

Figure 4. Show Current Network Settings

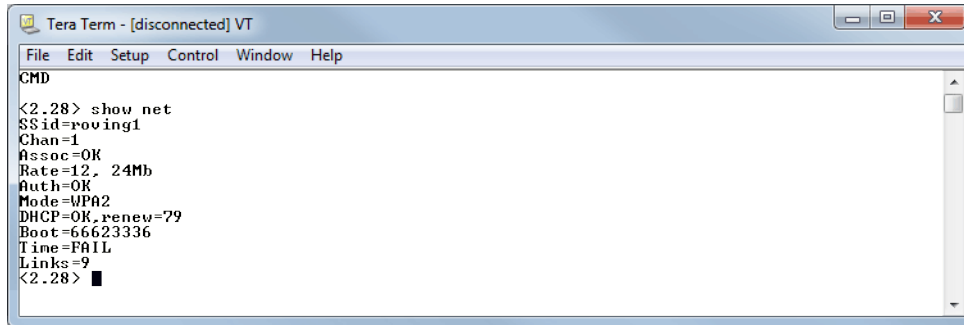

To issue commands to the module, you send a keyword followed by optional parameters. Commands are case sensitive, and you cannot use spaces in parameters. Use a \$ to indicate a space, e.g., **MY NETWORK** should be written as **MY\$NETWORK**. Additionally, you can use shorthand for the parameters. For example, the following commands are equivalent:

- **set uart baudrate 115200**
- **set uart b 115200**
- **set u b 15200**

NOTE: You cannot use shorthand for command keywords. For example, **s uart baudrate 115200** is illegal.

The WiFly module supports a variety of command keywords. The *Advanced User Manual*, which is available on the Support page of the Roving Networks website, provides a complete command reference. For evaluation purposes, you may view the current settings using the **get** command; **get everything** shows all parameters. Table 2 shows additional parameters for the **set** and **get** commands.

Table 2. Basic set & get Parameters

Parameter	Function
adhoc	Controls the ad hoc parameters.
broadcast	Controls the broadcast hello/heartbeat UDP message.
comm	Communication and data transfer, matching characters.
dns	DNS host and domain.
ftp	FTP host address and login information.
ip	IP settings.
option	Optional and infrequently used parameters.
sys	System settings, such as sleep and wake timers.
time	Realtime clock settings.
uart	Serial port settings, such as baud rate and parity.
wlan	Wireless interface, such as SSID, channel, and security options.

WI-FI CONNECTIONS

You can use the serial adapters to create a WiFi connection to a variety of applications such as:

- Remote environmental sensors
- Linking mobile devices such as GPS and light sensors
- Automotive diagnostics
- Industrial equipment monitoring and control

You can configure the WiFly serial adapter in infrastructure or point-to-point (ad hoc) networking setups. With the infrastructure setup, the adapter associates with an access point and is accessible from any machine on the LAN. You can extend this access to anywhere on the Internet by using dynamic DNS. The infrastructure setup is useful when the adapter is making connections to a server and uploading data. In the point-to-point setup, the adapter is connected via ad hoc mode to an iPhone, smartphone, or laptop computer to download the data or control a remote device through the serial interface.

Infrastructure Network Setup

From command mode you can view available networks, associate with a network, and see status of the network connection. To find all available networks, use the **scan** command. If the access point you want to associate with is running in open mode (no security) you can use the **join <my network>** command to associate with it.

If the access point is secure, you must set the pass phrase (WPA modes) or key (WEP modes) prior to issuing the **join** command. You do not need to set the authentication mode because the adapter determines the security protocol automatically. To set the pass phrase for WPA modes, use the command **set wlan phrase <string>**. For WEP modes, set the key using the **set wlan key <num>** command.

To configure the adapter to remember the network, use the command **set wlan ssid <my network>** and save the SSID and pass phrase or key to the configuration file using the **save** command. When the device next powers up, it uses the saved network information to associate with the network. The following commands show an example.

```
set wlan ssid <my network>
set wlan phrase <my secret code>
save
reboot
```

NOTE: For security purposes, you may wish to hide the pass phrase or key using the **set wlan hide** command. To show the pass phrase or key, simply reset it.

Ad Hoc Setup

You can configure the WiFly serial adapter for ad hoc networks via hardware or software commands. In ad hoc mode, the adapter looks like access point with which other WiFi devices can associate and open connections to the WiFly serial adapter.

NOTE: Currently the adapters only support the OPEN mode for creating ad hoc networks.

Enable Ad Hoc Mode via Hardware

To enable ad hoc mode via hardware, turn switch 1 on (refer back to Figure 1). On power up, the LEDs blink in sequence and an ad hoc network is created with the following settings:

SSID: WiFly-GSX-XX where XX is the final two bytes of the adapter's MAC address
Channel: 1
DHCP: OFF
IP address: 169.254.1.1
Netmask: 255.255.0.0

NOTE: When switch 1 is turned on, these settings override any other configuration settings.

Enable Ad Hoc Mode via Software

To enable ad hoc mode using software configuration, enter into command mode and set the join mode, SSID, and channel as shown in the following commands:

```
set wlan join 4  
set wlan ssid <my ad hoc network>  
set wlan chan 1
```

Turn off DHCP so that the module does not attempt to obtain an IP address from another source and set the IP address and netmask. Because automatic IP assignment fixes the first two bytes of the IP address, use a netmask of 255.255.0.0 so that other devices connecting to the module can be reached. You can also set the netmask to a smaller subnet if the other device's IP addresses begin statically at the same subnet as the ad hoc device.

```
set ip address 169.254.1.1  
set ip netmask 255.255.0.0  
set ip dhcp 0
```

Save your configuration. Upon rebooting the adapter is in ad hoc mode.

To associate with the WiFly serial adapter from an iPhone, smartphone, or computer, open the dialog box or window that shows the available networks. On the iPhone, touch the **Settings** icon. For Microsoft Windows, go to the **Control Panel / Networking and Sharing / Networking and Sharing Center** dialog box. Find the name of the adapter's ad hoc network in the list of available networks and select it to associate.

NOTE: Once associated with the ad hoc network (because there probably is no active DHCP server), the adapter automatically assigns an IP address. This process may take a few minutes to allocate an IP address for your computer. To work around it, you can assign a static IP address in the **Network settings > TCP/IP > Properties** menu.

After the iPhone, smartphone, or computer is associated with the ad hoc network, you can open a connection or telnet window as you would with an infrastructure mode connection.

NOTE: The adapter does not support ad hoc and infrastructure modes simultaneously.

Connection Modes

Two common operational modes are initiating a connection to a server and listening for a remote host connection. The configuration commands for these modes are shown in the following sections. The setup is described using infrastructure mode, i.e., with an access point, however, you can perform a similar setup using ad hoc networking.

Initiating a Connection from the Adapter

To initiate a connection from the adapter, perform the following steps in command mode:

1. Set the **wlan** properties so that the adapter connects to the network automatically upon power up. The following example uses the wireless network **my_network** and pass phrase **my_secret_code**.

```

set wlan join 1           // Auto join upon power up
set wlan chan 0          // Scan all channels
set wlan ssid my_network // Set the network name
set wlan phrase my_secret_code // Set the pass phrase

```

The **join 1** setting ensures that when the module wakes up, it tries to associate with the access point that matches the stored SSID, passkey, and channel. Setting the channel to 0 (the default), forces auto-scanning. Specifying the channel reduces the time it takes the adapter to find and associate with the access point.

2. Set the remote server's IP address and port so the adapter can connect to it when it wakes up.

```

set ip host 10.20.20.75 // Set the host IP address
set ip remote 3000     // Set the remote port
set sys autoconn 2    // Try to connect to the host every 2 seconds
save                  // Save configuration

```

NOTE: If **autoconn** is 1, the adapter only makes one attempt to auto connect.

3. Set the wake up and sleep conditions. By default, the serial adapter wakes up whenever data is written to the serial interface. You can also configure the device to wake up on CTS, on a PIO, or timer. See the *WiFly Advanced User Manual* for details. In the following example, the adapter wakes up on a timer and then sleeps after 2 minutes if there is no connection, or if it is connected and no data has been transferred for 30 seconds.

```

set sys sleep 120      // Sleep after 2 minutes if no connection
set sys trigger 2     // Wake on CTS
set conn idle 30     // Disconnect after 30 seconds of no data
save                  // Save all the settings to the configuration file
reboot                // Use the new settings

```

You can test this setup using a TCP server application that opens a socket on port 3000. Port Peeker is a free application that you can use to test the setup. It is available at <http://www.linklogger.com/portpeeker.htm>.

Waiting for the Remote Host to Connect to the Adapter (Listen Mode)

In this example, the adapter has a static IP address so that the remote host knows where the adapter is on the network. Alternatively, you can write your application software to listen for the broadcast UDP packet (automatically sent by the adapter by default) to identify the adapter and obtain the IP address and TCP port number on which the adapter is listening. Perform the following steps in command mode:

1. Set the **wlan** properties so that the device connects to the network automatically upon power up. The following example uses the wireless network **my_network** and pass phrase **my_secret_code**.

```

set wlan join 1           // Auto join on power up
set wlan chan 1          // Only look on channel 1
set wlan ssid my_network // Set the network name
set wlan phrase my_secret_code // Set the pass phrase

```

2. Configure the adapter's static IP address so that the remote application can connect. Turn off DHCP and set the IP gateway and netmask.

```
set ip address 10.20.20.63      // Set the IP address
set ip port 5030               // Set the local port on which to listen
set ip netmask 255.255.255.0   // Set the IP netmask
set ip gateway 10.20.20.1     // Set the network gateway
set ip dhcp 0                  // Turn off DHCP
```

3. Set the wake up and sleep conditions. In this mode, the sleep and wake timers are used to conserve battery power. Because it is unknown when the remote host will connect, the adapter should occasionally wake up and listen for the remote host. With these timers, the battery performs better if the adapter sleeps longer, but the remote host sees more latency when connecting.

WARNING: Do not set the sleep timer for less than 5 seconds or you will not be able to go back into command mode to reconfigure the adapter before it goes back to sleep.

```
set sys wake 20                // Wake after 20 seconds
set sys sleep 10              // Go to sleep after 10 seconds
save                           // Save configuration
reboot                         // Restart using the new configuration
```

You can now test this configuration using telnet on a computer sharing the same network as the WiFly serial adapter.

SERIAL CONNECTOR SPECIFICATION

The WiFly serial adapters have male or female DB9 connectors. Refer to Figure 5 and Table 3 for the pin-out.

Figure 5. DB9 Connector Pins

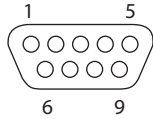

Table 3. DB9 Connector Pin-Out

Pin	WiFly Serial Adapter Male DB9	WiFly Serial Adapter Female DB9
1	NC	NC
2	RXD	TXD
3	TXD	RXD
4	NC	NC
5	GND	GND
6	NC	NC
7	RTS	CTS
8	CTS	RTS
9	4 – 12 VDC	4 – 12 VDC

NOTE: The RS-232 interface uses the SIPEX SP3232ECA chip with capacitor switch to generate the + and – signals, therefore, it is not driving the full RS-232 voltages. Devices stealing power from the RS-232 pins may not have enough voltage.

RESOURCES & RELATED DOCUMENTS

For more information, refer to the following sources, which are available on the Support page on the Roving Networks website at <http://www.rovingnetworks.com/support.php>:

- *RN-171 Data Sheet*
- *RN-131 Data Sheet*
- *Advanced User Manual*
- *WiFly Training Presentation*
- Drivers, tools, and utilities

APPENDIX A - NULL MODEM & FLOW CONTROL JUMPERS

You can configure the adapters' serial interface to enable flow control and null modem signaling. You access the jumper block by removing the cover from the WiFly serial adapter. Figure 6 shows the jumper setting for various signals.

WARNING: Flow control signals are NOT RS-232 signaling tolerant. If you enable these signals with the jumpers, do not exceed 3.3-V DC or permanent damage can occur.

Figure 6. Jumpers

Male DB9 (Default Configuration)
Jumper 1 < > 2, 3 < > 4

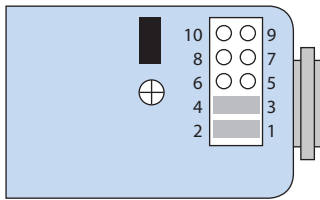

Male DB9 - Null Modem
Jumper 2 < > 4, 1 < > 3

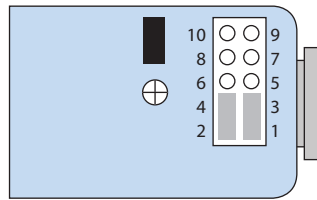

Female DB9 (Default Configuration)
Jumper 2 < > 4, 1 < > 3

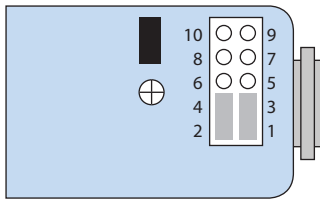

Female DB9 - Null Modem
Jumper 1 < > 2, 3 < > 4

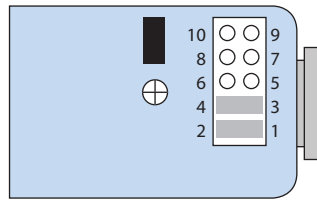

Drive DSR on Pin 6 of the Male DB9
Jumper 5 < > 6

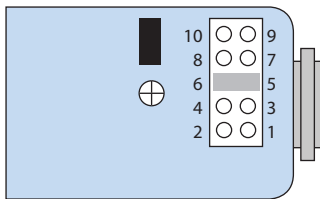

Drive DTR on Pin 4 of the Male DB9
Jumper 7 < > 8

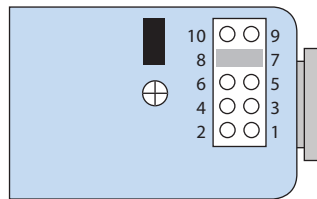

Drive DCD on Pin 1 of the Male DB9
Jumper 9 < > 10

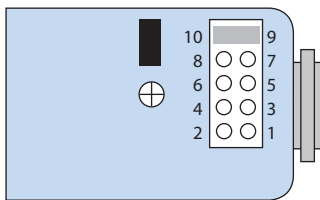

Roving Networks, Inc.
102 Cooper Court
Los Gatos, CA 95032
+1 (408) 395-5300
www.rovingnetworks.com

Copyright © 2011 Roving Networks. All rights reserved. Roving Networks is a registered trademark of Roving Networks. Apple Inc., iPhone, iPad, iTunes, Made for iPhone are registered trademarks of Apple Computer.

Roving Networks reserves the right to make corrections, modifications, and other changes to its products, documentation and services at any time. Customers should obtain the latest relevant information before placing orders and should verify that such information is current and complete.

Roving Networks assumes no liability for applications assistance or customer's product design. Customers are responsible for their products and applications which use Roving Networks components. To minimize customer product risks, customers should provide adequate design and operating safeguards.

Roving Networks products are not authorized for use in safety-critical applications (such as life support) where a failure of the Roving Networks product would reasonably be expected to cause severe personal injury or death, unless officers of the parties have executed an agreement specifically governing such use.