

ADJUSTABLE PRECISION ZENER SHUNT REGULATOR

ISSUE 2 – FEBRUARY 1997

ZHT431

DEVICE DESCRIPTION

The ZHT431 is a three terminal adjustable shunt regulator offering excellent temperature stability and output current handling capability up to 100mA. The device offers extended operating temperature range working from -55 to +125°C. The output voltage may be set to any chosen voltage between 2.5 and 20 volts by selection of two external divider resistors.

The devices can be used as a replacement for zener diodes in many applications requiring an improvement in zener performance.

FEATURES

- Surface mount SO8, SOT89, SOT223 and SOT23 packages
- TO92 package
- 2% and 1% tolerance
- Maximum temperature coefficient 67 ppm/°C
- Temperature compensated for operation over the full temperature range
- Programmable output voltage
- 50µA to 100mA current sink capability
- Low output noise
- Wide temperature range -55 to +125°C

APPLICATIONS

- Series and Shunt regulator
- Voltage monitor
- Over voltage/ under voltage protection
- Switch mode power supplies

SCHEMATIC DIAGRAM

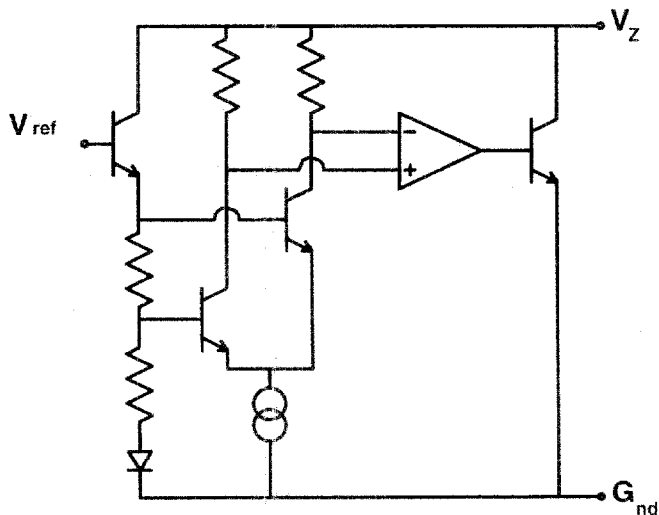

ZHT431

ABSOLUTE MAXIMUM RATING

Cathode Voltage (V _Z)	20V
Cathode Current	150mA
Operating Temperature	-55 to 125°C
Storage Temperature	-55 to 150°C

Power Dissipation (T_{amb}=25°C)

(T _{jmax} = 150°C)	
SOT23	330mW
TO92	780mW
SOT223	2W
SO8	780mW
SOT89	1.5W

Recommended Operating Conditions

	Min	Max
Cathode Voltage	V _{ref}	20V
Cathode Current	50μA	100mA

ELECTRICAL CHARACTERISTICS TEST CONDITIONS (Unless otherwise stated): T_{amb}=25°C

PARAMETER	SYMBOL	VALUE			UNITS	CONDITIONS
		MIN	TYP	MAX		
Reference Voltage	2% V _{ref} 1% V _{ref}	2.45 2.475	2.50 2.50	2.55 2.525	V	I _L =10mA (Fig1), V _Z =V _{ref}
Deviation of Reference Input Voltage over Temperature	V _{dev}		10	30	mV	I _L =10mA, V _Z =V _{ref} T _a =full range (Fig1)
Ratio of the change in Reference Voltage to the Change in Cathode Voltage	$\frac{\Delta V_{ref}}{\Delta V_Z}$		-1.85	-2.7	mV/V	V _Z from V _{ref} to 10V I _Z =10mA (Fig2)
			-1.0	-2.0	mV/V	V _Z from 10V to 20V I _Z =10mA (Fig2)
Reference Input Current	I _{ref}		0.12	1.0	μA	R1=10k, R2=O/C, I _L =10mA (Fig2)
Deviation of Reference Input Current over Temperature	ΔI _{ref}		0.04	0.2	μA	R1=10k, R2=O/C, I _L =10mA T _a =full range (Fig2)
Minimum Cathode Current for Regulation	I _{Zmin}		35	50	μA	V _Z =V _{ref} (Fig1)
Off-state Current	I _{Zoff}			0.1	μA	V _Z =20V, V _{ref} =0V(Fig3) †
Dynamic Output Impedance	R _Z			0.75	Ω	V _Z =V _{ref} (Fig1), f=0Hz, I _C =1mA to 100mA

Deviation of reference input voltage, V_{dev}, is defined as the maximum variation of the reference input voltage over the full temperature range.

The average temperature coefficient of the reference input voltage, V_{ref} is defined as:

$$V_{ref} (\text{ppm}^\circ\text{C}) = \frac{V_{dev} \times 1000000}{V_{ref} (T_1 - T_2)}$$

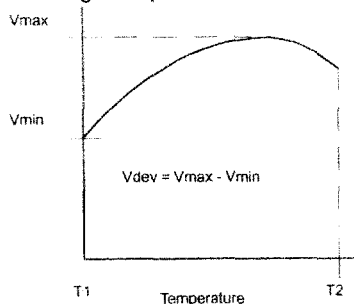

The dynamic output impedance, R_Z, is defined as:

$$R_Z = \frac{\Delta V_Z}{\Delta I_Z}$$

When the device is programmed with two external resistors, R₁ and R₂, (fig 2), the dynamic output impedance of the overall circuit, R', is defined as:

$$R' = R_Z \left(1 + \frac{R_1}{R_2}\right)$$

ZHT431

TYPICAL CHARACTERISTICS

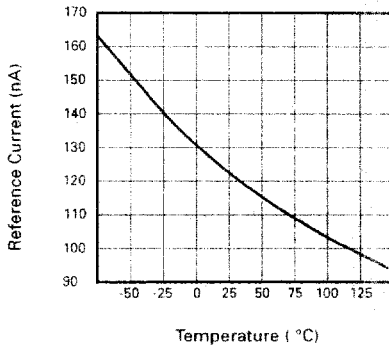

I_{ref} vs. Temperature

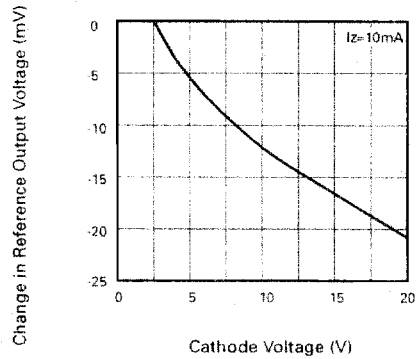

Change in V_{ref} v Cathode Voltage

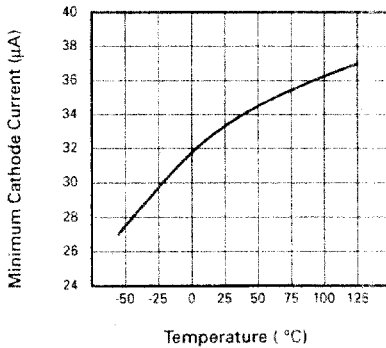

I_{zmin} vs. Temperature

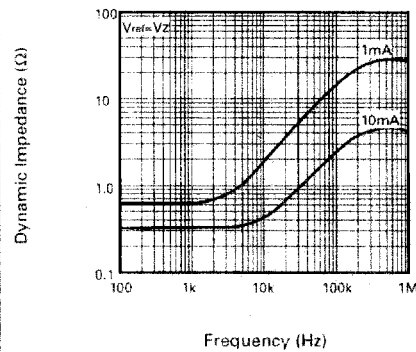

Dynamic Impedance v Frequency

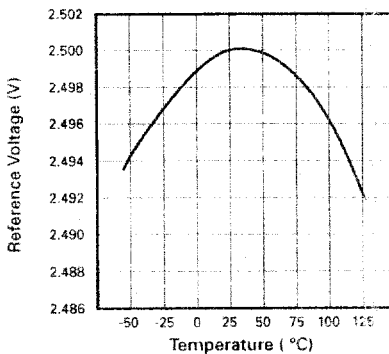

V_{ref} vs. Temperature

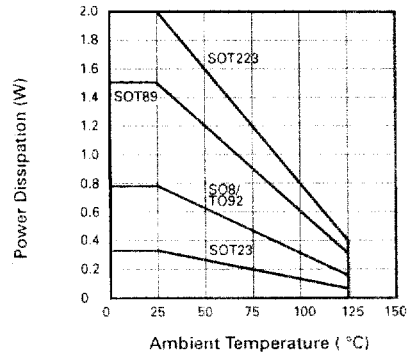

Power Dissipation Derating

ZHT431

TYPICAL CHARACTERISTICS

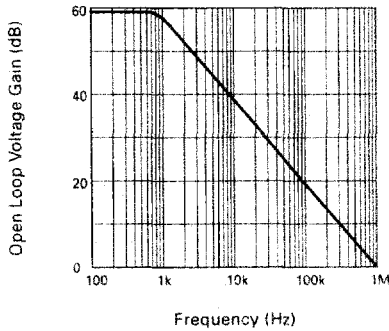

Gain v Frequency

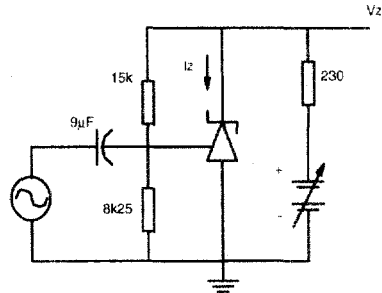

$I_Z = 10\text{mA}$, $T_A = 25^\circ\text{C}$

Test Circuit for Open Loop Voltage Gain

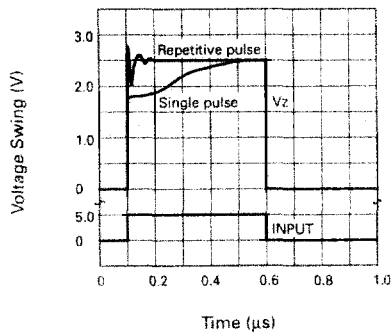

Pulse Response

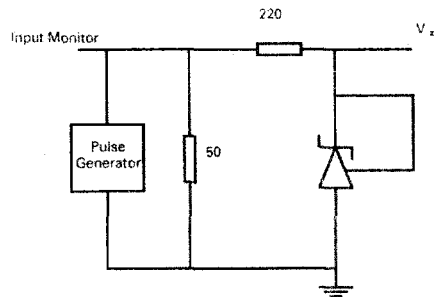

$T_A = 25^\circ\text{C}$

Test Circuit for Pulse Response

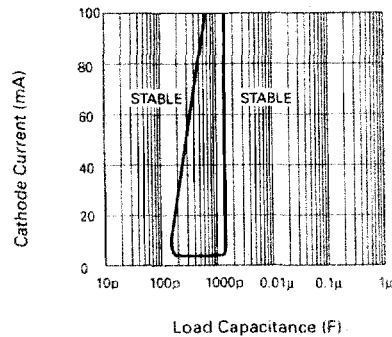

Stability Boundary Conditions

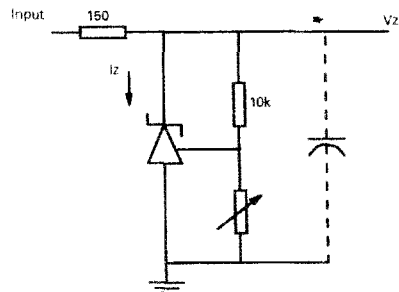

$V_{ref} < V_Z < 20$, $I_Z = 10\text{mA}$, $T_A = 25^\circ\text{C}$

Test Circuit for Stability Boundary Conditions

ZHT431

DC TEST CIRCUITS

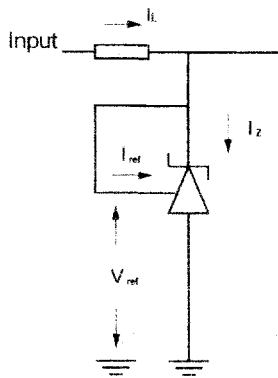

Fig 1 - Test Circuit for $V_z = V_{ref}$

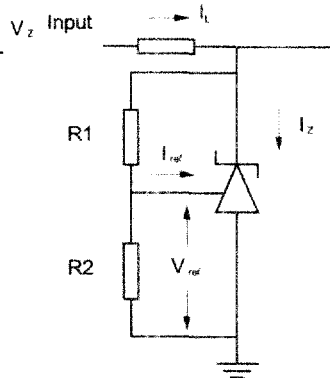

Fig 2 - Test Circuit for $V_z > V_{ref}$

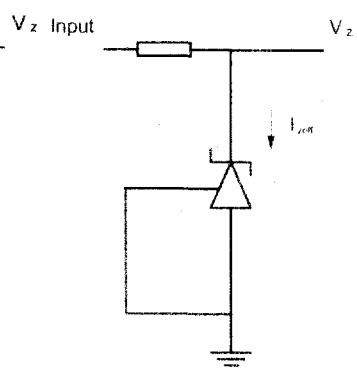

Fig 3 - Test Circuit for Off State current †

NOTE

† Since the "Off State" disables all internal circuitry including leakage control, operating in this mode at high temperature is not recommended.

ZHT431

APPLICATION CIRCUITS

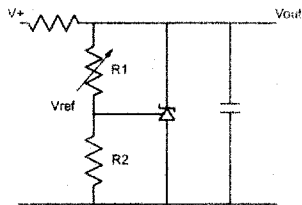

$$V_{out} = \left(1 + \frac{R1}{R2}\right) V_{ref}$$

SHUNT REGULATOR

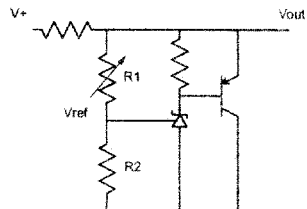

$$V_{out} = \left(1 + \frac{R1}{R2}\right) V_{ref}$$

HIGHER CURRENT SHUNT REGULATOR

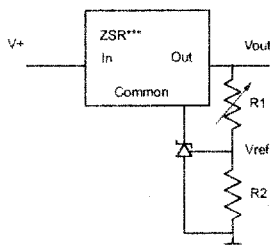

$$V_{out_MIN} = V_{ref} + V_{reg}$$

$$V_{out} = \left(1 + \frac{R1}{R2}\right) V_{ref}$$

OUTPUT CONTROL OF A THREE TERMINAL FIXED REGULATOR

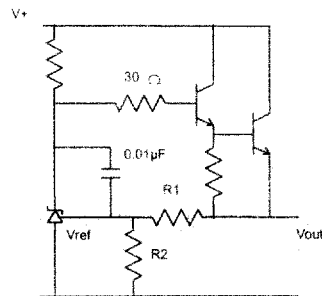

$$V_{out} = \left(1 + \frac{R1}{R2}\right) V_{ref}$$

SERIES REGULATOR

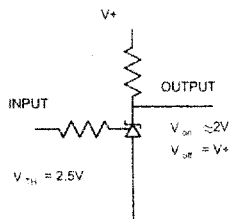

SINGLE SUPPLY COMPARATOR WITH TEMPERATURE COMPENSATED THRESHOLD

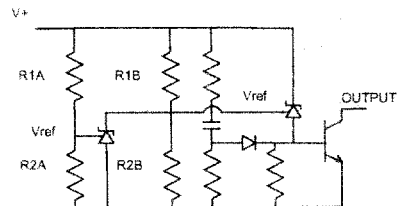

$$\text{Low limit} = \left(1 + \frac{R1B}{R2B}\right) V_{ref}$$

$$\text{High limit} = \left(1 + \frac{R1A}{R2A}\right) V_{ref}$$

OVER VOLTAGE / UNDER VOLTAGE PROTECTION CIRCUIT

ZHT431

CONNECTION DIAGRAMS

SO8 Package Suffix - N8

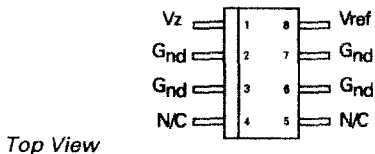

SOT223 Package Suffix - G

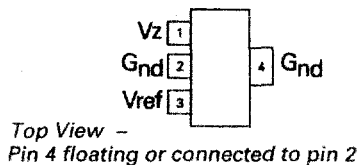

SOT23 Package Suffix - F

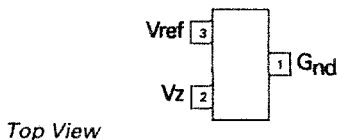

TO92 Package Suffix - C

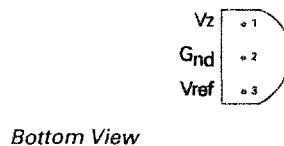

ORDERING INFORMATION

PART No	TOL %	PACKAGE	PARTMARK
ZHT431N802	2	SO8	ZHT43102
ZHT431N801	1	SO8	ZHT43101
ZHT431G02	2	SOT223	ZHT43102
ZHT431G01	1	SOT223	ZHT43101
ZHT431F02	2	SOT23	43D
ZHT431F01	1	SOT23	43C
ZHT431C02	2	TO92	ZHT43102
ZHT431C01	1	TO92	ZHT43101
ZHT431Z02	2	SOT89	43F
ZHT431Z01	1	SOT89	43E

SOT89 Package Suffix - Z

