



## AC SERIES - A TYPE THERMOPLASTIC XLR PCB CHASSIS CONNECTORS



The AC series, A type XLR chassis receptacles have been designed and manufactured with the Original Equipment Manufacturers' (OEM) needs in mind. The compact shell design allows a significant space saving over the traditional 'D' type shell. Gold plated contacts improve the performance, ensuring a reliable contact and the unique grounding link options offer flexibility in design.

### Features

- A leading first mate last break socket contact is standard on all female connectors (Pin 1).
- Vertical and Horizontal PCB versions available.
- Latching and Non-latching versions available.
- A range of different grounding options are available including:
  - Mating connector shell to Pin 1
  - Mating connector shell to Chassis
  - Mating connector shell to pin 1 to Chassis
- Available in 3 contact arrangement only.
- Compatible with all other XLR brands.

### Options

- Vertical PCB contacts
- Horizontal PCB contacts
- Precision Machined Pin contacts
- Cost effective Stamped Socket contacts
- Gold Plated contacts (Standard)
- Silver Plated contacts (Optional)
- Bulk Packaging

### Ordering Codes

We have listed the more common ordering codes in each section. For further options please refer to the part number breakdown charts. Please contact us if you need any further assistance.

### Simple steps to guide you in using this catalogue

- 1) Identify the product group listed in Contents on Page 1 and go directly to that page number.
- 2) Each product group cover page then details information and options available.
- 3) Refer to the product detail pages and identify the product you require pictorially.
- 4) Read the product description column for the products standard features.
- 5) Use variations column to determine your choice.
- 6) Identify part number.
- 7) In the event the particular option you require is not listed please refer to the part number breakdown page at the end of each section.
- 8) Please contact us directly if you have any further problems.



**Features:**











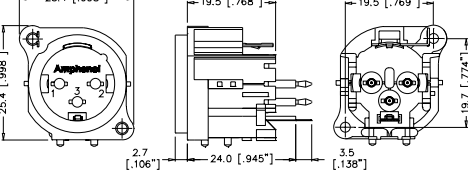

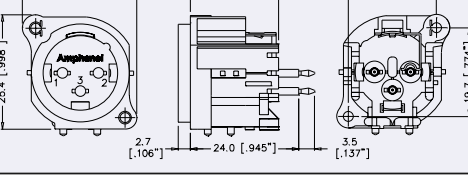

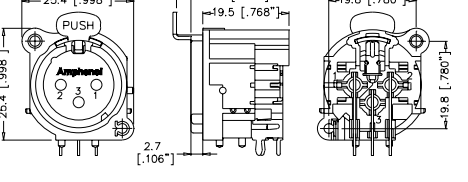
- Thermoplastic Shell
- Industry standard PCB footprints.
- Vertical or Horizontal PCB mounting.
- Precision machined pin contacts.
- Gold plated contacts.
- Leading first mate last break socket contact.
- Bulk packed in trays, 100 to a box as standard.
- Positive latch lock system.

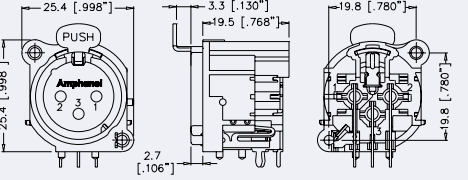
**Options:** Silver plated contacts, Vertical or Horizontal PCB, Various grounding methods, Latching or Non-Latching.

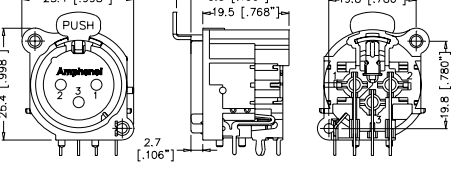
**Part Number Breakdown:** Page 32-33 **Specifications:** Page 34  
**PCB Footprints:** Page 35 **Panel Cutouts:** Page 36

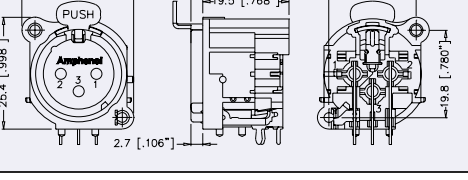

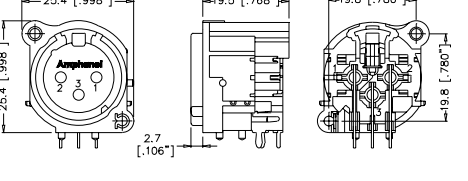

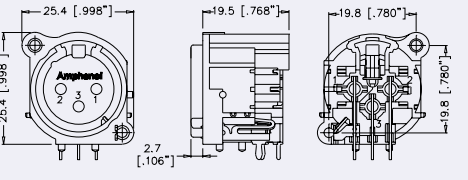



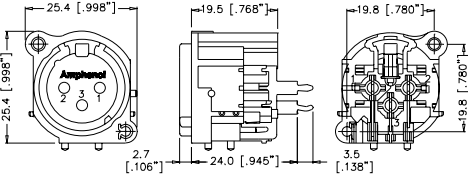

PRODUCT - FIGURE	DRAWING	Dimensions in mm (inches)	DESCRIPTION	GROUND LINK VARIATIONS	PART NUMBER
			XLR 3 pole male, Horizontal PCB, Gold Plated Contacts, Bulk Pack	No Ground Link	AC3MAH-AU-B
			XLR 3 pole male, Horizontal PCB, Gold Plated Contacts, Bulk Pack	Pin 1 to Chassis to Mating connector shell	AC3MAH1-AU-B
			XLR 3 pole male, Horizontal PCB, Gold Plated Contacts, Bulk Pack	Mating connector shell to Chassis - Pin 1 sep. Ground	AC3MAH2-AU-B
			XLR 3 pole male, Horizontal PCB, Gold Plated Contacts, Bulk Pack	Mating connector shell to Pin 1	AC3MAH3-AU-B
			XLR 3 pole male, Vertical PCB, Gold Plated Contacts, Bulk Pack	No Ground Link	AC3MAV-AU-B
			XLR 3 pole male, Vertical PCB, Gold Plated Contacts, Bulk Pack	Pin 1 to Chassis to Mating connector shell	AC3MAV1-AU-B

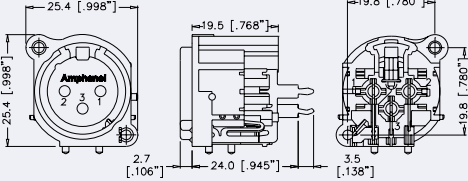

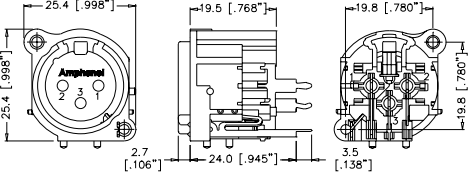
PRODUCT - FIGURE	DRAWING	Dimensions in mm (inches)	DESCRIPTION	GROUND LINK VARIATIONS	PART NUMBER
		25.4 [ .998" ] 19.5 [ .768" ] 19.5 [ .769" ] 2.7 [ .106" ] 24.0 [ .945" ] 3.5 [ .138" ] 19.7 [ .774" ]	XLR 3 pole male, Vertical PCB, Gold Plated Contacts, Bulk Pack	Mating connector shell to Chassis - Pin 1 sep. Ground	AC3MAV2-AU-B
		25.4 [ .998" ] 19.5 [ .768" ] 19.5 [ .769" ] 2.7 [ .106" ] 24.0 [ .945" ] 3.5 [ .137" ] 19.7 [ .774" ]	XLR 3 pole male, Vertical PCB, Gold Plated Contacts, Bulk Pack	Mating connector shell to Pin 1	AC3MAV3-AU-B
		25.4 [ .998" ] 19.5 [ .768" ] 19.8 [ .780" ] 2.7 [ .106" ] 3.3 [ .130" ] 19.8 [ .780" ]	XLR 3 pole female, Horizontal PCB, Latching Type, Gold Plated Contacts, Bulk Pack	No Ground Link	AC3FAH-AU-B
		25.4 [ .998" ] 19.5 [ .768" ] 19.8 [ .780" ] 2.7 [ .106" ] 3.3 [ .130" ] 19.8 [ .780" ]	XLR 3 pole female, Horizontal PCB, Latching Type, Gold Plated Contacts, Bulk Pack	Pin 1 to Chassis to Mating connector shell	AC3FAH1-AU-B
		25.4 [ .998" ] 19.5 [ .768" ] 19.8 [ .780" ] 2.7 [ .106" ] 3.3 [ .130" ] 19.8 [ .780" ]	XLR 3 pole female, Horizontal PCB, Latching Type, Gold Plated Contacts, Bulk Pack	Mating connector shell to Chassis - Pin 1 sep. Ground	AC3FAH2-AU-B
		25.4 [ .998" ] 19.5 [ .768" ] 19.8 [ .780" ] 2.7 [ .106" ] 3.3 [ .130" ] 19.8 [ .780" ]	XLR 3 pole female, Horizontal PCB, Latching Type, Gold Plated Contacts, Bulk Pack	Pin 1 to Chassis	AC3FAH3-AU-B
		25.4 [ .998" ] 19.5 [ .768" ] 19.8 [ .780" ] 2.7 [ .106" ]	XLR 3 pole female, Horizontal PCB, Non-Latching Type Gold Plated Contacts, Bulk Pack	No Ground Link	AC3FAHL-AU-B
		25.4 [ .998" ] 19.5 [ .768" ] 19.8 [ .780" ] 2.7 [ .106" ]	XLR 3 pole female, Horizontal PCB, Non-Latching Type Gold Plated Contacts, Bulk Pack	Pin 1 to Chassis to mating connector shell	AC3FAHL1-AU-B

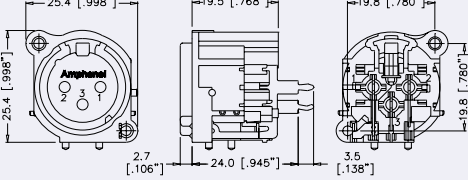
PRODUCT - FIGURE	DRAWING	Dimensions in mm (inches)	DESCRIPTION	GROUND LINK VARIATIONS	PART NUMBER
			XLR 3 pole female, Horizontal PCB, Non-Latching Type Gold Plated Contacts, Bulk Pack	Mating connector shell to Chassis - Pin 1 sep. Ground.	AC3FAHL2-AU-B
			XLR 3 pole female, Horizontal PCB, Non-Latching Type Gold Plated Contacts, Bulk Pack	Pin 1 to Chassis	AC3FAHL3-AU-B
			XLR 3 pole female, Vertical PCB, Latching Type, Gold Plated Contacts, Bulk Pack	No Ground Link	AC3FAV-AU-B
			XLR 3 pole female, Vertical PCB, Latching Type, Gold Plated Contacts, Bulk Pack	Pin 1 to Chassis to mating connector shell	AC3FAV1-AU-B
			XLR 3 pole female, Vertical PCB, Latching Type, Gold Plated Contacts, Bulk Pack	Mating connector shell to Chassis - Pin 1 sep. Ground.	AC3FAV2-AU-B
			XLR 3 pole female, Vertical PCB, Latching Type, Gold Plated Contacts, Bulk Pack	Pin 1 to Chassis	AC3FAV3-AU-B
			XLR 3 pole female, Vertical PCB, Latching Type, Gold Plated Contacts, Bulk Pack, Machined Contact Mount	Mating connector shell to Chassis - Pin 1 sep. Ground.	AC3FAV4-AU-B
			XLR 3 pole female, Vertical PCB, Latching Type, Gold Plated Contacts, Bulk Pack, Machined Contact Mount	No Ground Link	AC3FAV5-AU-B

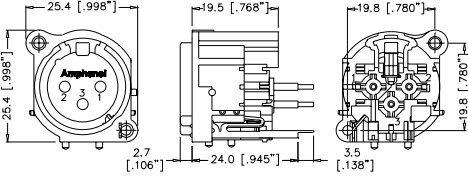

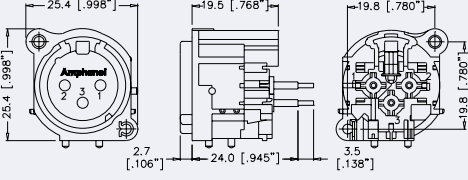
PRODUCT - FIGURE	DRAWING Dimensions in mm (inches)	DESCRIPTION	GROUND LINK VARIATIONS	PART NUMBER
		XLR 3 pole female, Vertical PCB, Non-Latching Type, Gold Plated Contacts, Bulk Pack	No Ground Link	AC3FAVL-AU-B
		XLR 3 pole female, Vertical PCB, Non-Latching Type, Gold Plated Contacts, Bulk Pack	Pin 1 to Chassis to Mating connector shell	AC3FAVL1-AU-B
		XLR 3 pole female, Vertical PCB, Non-Latching Type, Gold Plated Contacts, Bulk Pack	Mating connector shell to Chassis - Pin 1 sep. Ground.	AC3FAVL2-AU-B
		XLR 3 pole female, Vertical PCB, Non-Latching Type, Gold Plated Contacts, Bulk Pack	Pin 1 to Chassis	AC3FAVL3-AU-B
		XLR 3 pole female, Vertical PCB, Non-Latching type, Gold Plated Contacts, Bulk Pack, Machined Contact Mount	Mating connector shell to Chassis - Pin 1 sep. Ground.	AC3FAVL4-AU-B
		XLR 3 pole female, Vertical PCB, Non-Latching type, Gold Plated Contacts, Bulk Pack, Machined Contact Mount	No Ground Link	AC3FAVL5-AU-B



## PART NUMBER BREAKDOWN

### AC SERIES A TYPE MALE



E. G . **AC3MAVL3-AU BULK**  
**AC** (series prefix), **3** contacts, **M**ale, **A** Type, **V**ertical Printed Circuit Board, **L**atchless, **3** (Mating Shell to Pin 1 Grounding), - **AU** (Gold Plated Contacts), **B**ulk Packaged.

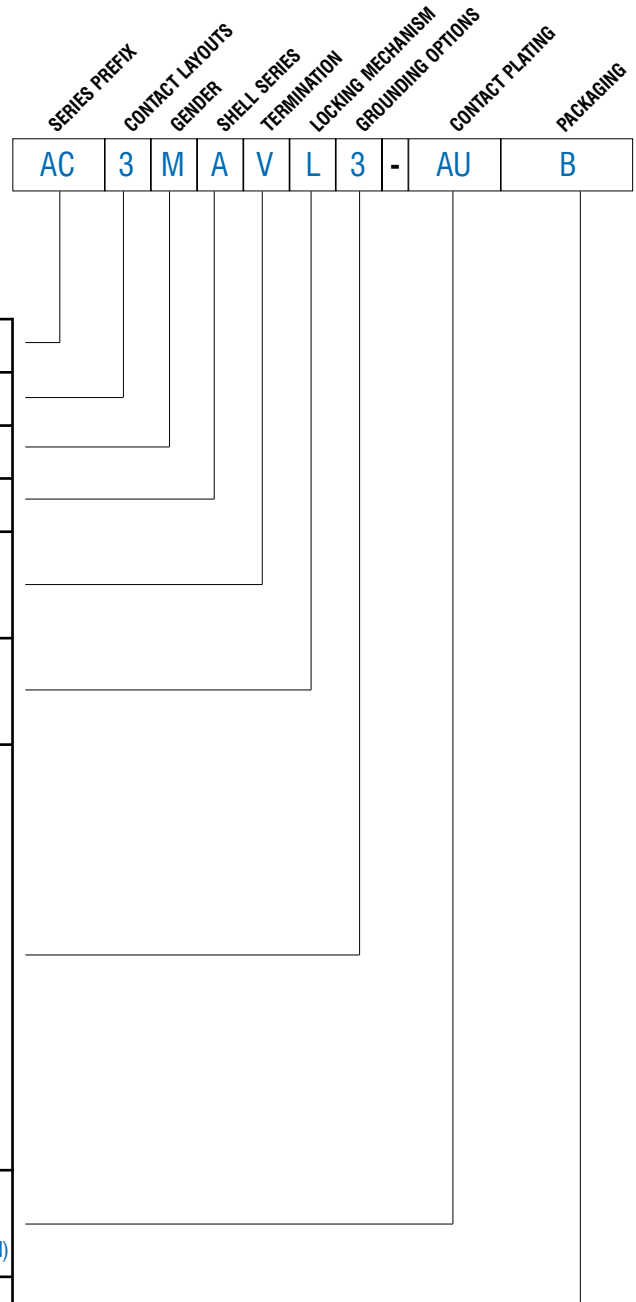

<b>SERIES PREFIX</b>	AC	=	Series Prefix
<b>CONTACT LAYOUT</b>	3	=	3 Contacts only
<b>GENDER</b>	M	=	Male Pin Contacts
<b>SHELL SERIES</b>	A	=	A Type
<b>TERMINATION</b>	H	=	Horizontal Printed Circuit Board
	V	=	Vertical Printed Circuit Board
<b>LOCKING MECHANISM</b>	Blank	=	Latching
	L	=	Latchless
<b>GROUNDING LINK OPTIONS</b>	Blank	=	No Ground Link
	1	=	Pin 1 to Chassis to mating connector shell
	2	=	Mating connector shell to Chassis - Pin 1 sep. Ground.
	3	=	Mating connector to Pin 1
<b>CONTACT PLATING</b>	AU	=	Gold Plated Contacts
	AG	=	Silver Plated Contacts (Non-Standard)
<b>PACKAGING</b>	B	=	Bulk Packed



## PART NUMBER BREAKDOWN

### AC SERIES A TYPE FEMALE

E. G. **AC3FAVL3-AU BULK**

**AC** (series prefix), **3** contacts, **F** Female, **A** Type, **V** Vertical Printed Circuit Board, **L** Latchless, **3** (Pin 1 to Chassis Grounding), - **AU** (Gold Plated Contacts), **B** Bulk Packaged.

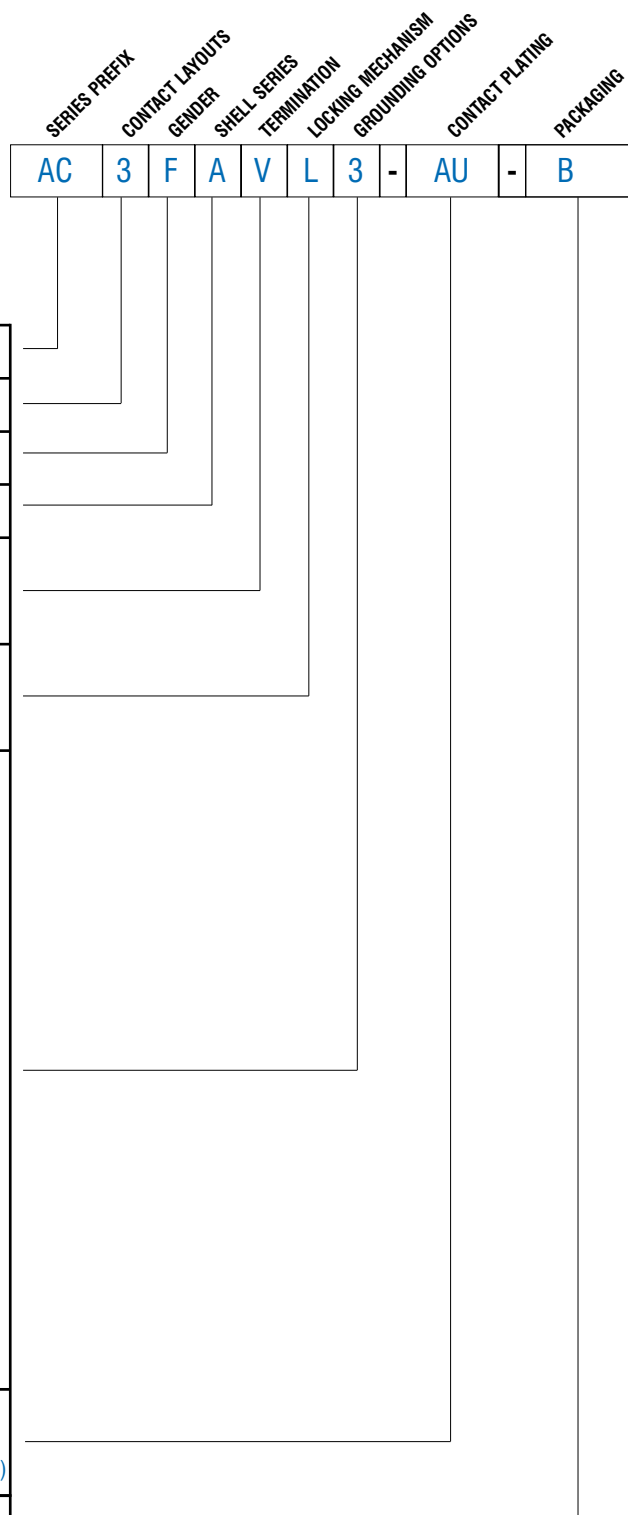

<b>SERIES PREFIX</b>	AC	=	Series Prefix
<b>CONTACT LAYOUT</b>	3	=	3 Contacts only
<b>GENDER</b>	F	=	Female Socket Contacts
<b>SHELL SERIES</b>	A	=	A Type
<b>TERMINATION</b>	H	=	Horizontal Printed Circuit Board
	V	=	Vertical Printed Circuit Board
<b>LOCKING MECHANISM</b>	Blank	=	Latching
	L	=	Latchless
<b>GROUNDING LINK OPTIONS</b>	Blank	=	No Ground Link
	1	=	Pin 1 to Chassis to mating connector shell
	2	=	Mating connector shell to Chassis - Pin 1 sep. Ground.
	3	=	Pin 1 to Chassis
	4	=	Mating Shell to Chassis & Pin 1 Seperate Ground / Machined Contacts
	5	=	No Ground Link / Machined Contacts
<b>CONTACT PLATING</b>	AU	=	Gold Plated Contacts
	AG	=	Silver Plated Contacts (Non-Standard)
<b>PACKAGING</b>	B	=	Bulk Packed



## STANDARD DATA AC SERIES A TYPE CHASSIS

		VALUE
<b>GENERAL CHARACTERISTICS</b>	Number of contacts	3
	Contact Arrangements (Front view of pin insert)	
	Termination	Printed Circuit Board (PCB)
	Flammability rating of plastics	UL94V-0
<b>ELECTRICAL CHARACTERISTICS</b>	Service Voltage RMS	133V <sup>1)</sup>
	Test Voltage AC RMS	1500V
	Current carrying capacity	6A
	Typical Contact Resistance	≤ 5mΩ
	Insulation Resistance (initial)	≥ 2GΩ
	Insulation Resistance (after damp heat test)	≥ 2GΩ
<b>CLIMATIC CHARACTERISTICS</b>	Protection Class	IP40
	Operating Temperature	-30 °C to +80 °C
<b>MECHANICAL CHARACTERISTICS</b>	Weight <sup>2)</sup>	14g (0.030lb)
	Retention Spring separating force	≥ 20N
	Mounting Hole torque max.	1.5Nm
	Mechanical Operations	1500 mating cycles
	Fastening	Self-Tapping PT screw with thread 2.9 x 1.06 and of Tri-rondular configuration
<b>MATERIALS</b>	Connector Shell	PA6.6 + 25% glass fibre reinforced, ULV94V-0
	Shell Finish	Black
	Insulators	PA6.6 + 25% glass fibre reinforced, ULV94V-0
	Male Contact	
	Material	Bronze
	Plating	0.0762μm (3μ") gold over 0.0762μm (30μ") nickel
	Female Contact	
	Material	Brass
Plating	0.0762μm (3μ") gold over 0.0762μm (30μ") nickel	
Latch lock and Spring	SUS (AISI - 301) - Nickel Plated	
Ground element	Bronze - Nickel Plated	

<sup>1)</sup> Not suitable for domestic applications above 50V

<sup>2)</sup> Approximate weight only, does not include packaging. Please contact us for exact weight for shipping purposes.



## AC SERIES A TYPE CHASSIS

### PCB FOOTPRINTS STRAIGHT (V) - CONNECTOR SIDE OF PCB

**AC3FAH  
AC3FAH2**

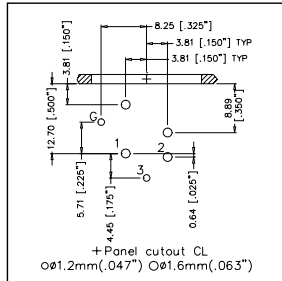

**AC3FAH1  
AC3FAH3**

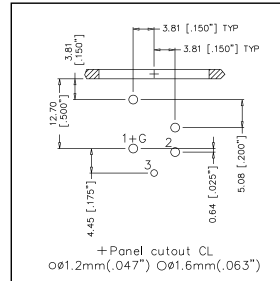

**AC3FAV  
AC3FAV2**

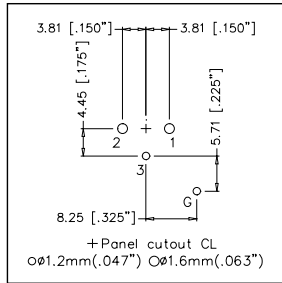

**AC3FAV1  
AC3FAV3**

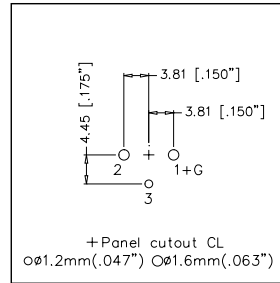

**AC3FAV4**

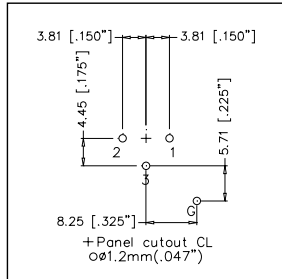

**AC3FAV5**

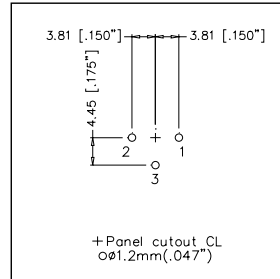

**AC3MAH  
AC3MAH2**

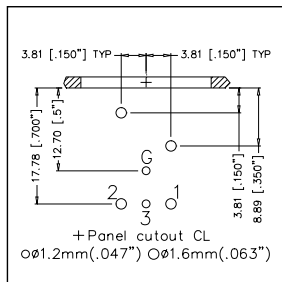

**AC3MAH1  
AC3MAH3**

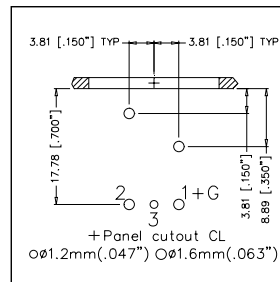

**AC3MAV  
AC3MAV2**

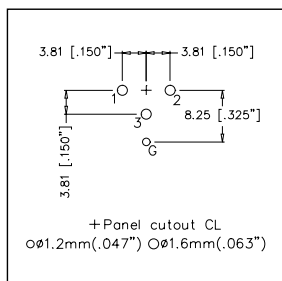

**AC3MAV1  
AC3MAV3**

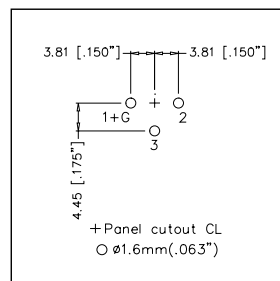

## AC SERIES A TYPE CHASSIS

### PANEL CUTOUT DIMENSIONS - FRONT VIEW

**A TYPE**

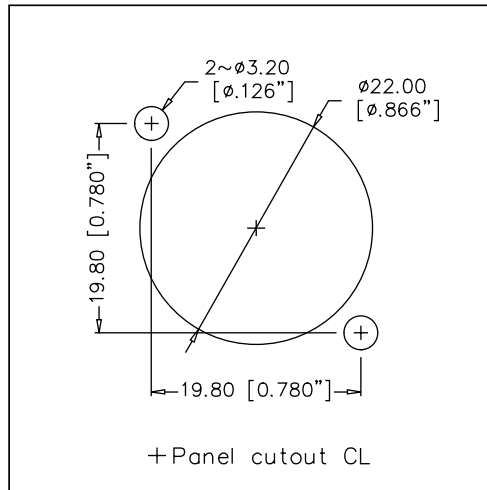

**A TYPE MALE  
MOUNTING PITCH**

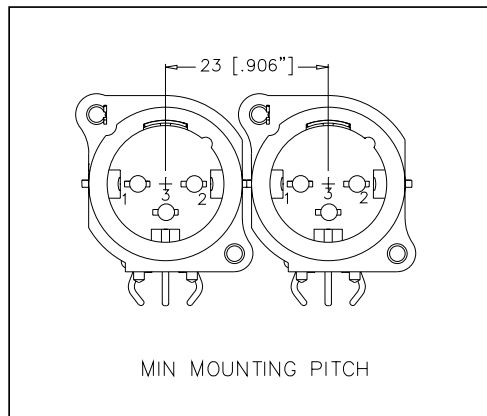

**A TYPE FEMALE  
MOUNTING PITCH**

