

## General Description

The AAT1106 is a 1.5MHz constant frequency current mode PWM step-down SwitchReg™ converter with a unique adaptive slope compensation scheme allowing the device to operate with a lower range of inductor values to optimize size and provide efficient operation. It is ideal for portable equipment powered by single-cell Lithium-ion batteries and is optimized for high efficiency, achieving levels up to 96%.

The AAT1106 can supply up to 600mA load current from a 2.5V to 5.5V input voltage and the output voltage can be regulated as low as 0.6V. The device also can run at 100% duty cycle for low dropout operation, extending battery life in portable systems. In addition, light load operation provides very low output ripple for noise sensitive applications and the 1.5MHz switching frequency minimizes the size of external components while keeping switching losses low.

The AAT1106 is available in a Pb-free, low-profile 5-pin TSOT23 package, and is rated over the -40°C to +85°C temperature range.

## Features

- $V_{IN}$  Range: 2.5V to 5.5V
- $V_{OUT}$ : Adjustable 0.6V to  $V_{IN}$
- Up to 600mA Output Current
- Up to 96% Efficiency
- 1.5MHz Switching Frequency
- 100% Duty Cycle Dropout Operation
- Adaptive Slope Compensated Current Mode Control for Excellent Line and Load Transient Response
- <math>1\mu A</math> Shutdown Current
- Short-Circuit and Thermal Fault Protection
- TSOT23-5 Package
- -40°C to +85°C Temperature Range

## Applications

- Cellular Phones, Smartphones
- Digital Still Cameras
- Digital Video Cameras
- Microprocessor and DSP Core Supplies
- MP3 and Portable Media Players
- PDAs
- Wireless and DSL Modems

## Typical Application

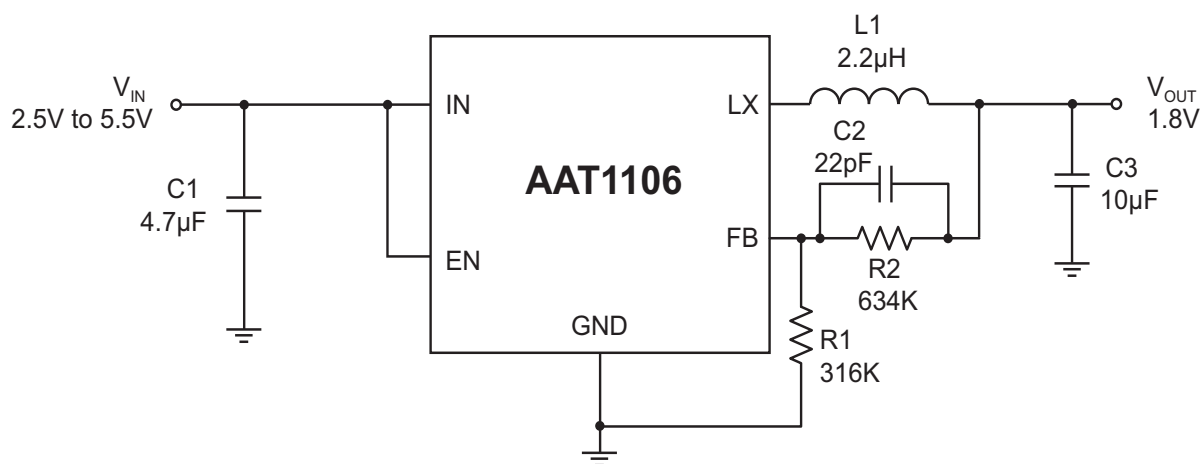

**Pin Descriptions**

Pin #	Symbol	Function
1	EN	Enable pin. Active high. In shutdown, all functions are disabled drawing <math><1\mu\text{A}</math> supply current. Do not leave EN floating.
2	GND	Ground pin.
3	LX	Switching node. Connect the output inductor to this pin. Connects to the drains of the internal P- and N-channel MOSFET switches.
4	IN	Supply input pin. Must be closely decoupled to GND with a $2.2\mu\text{F}$ or larger ceramic capacitor.
5	FB	Feedback input pin. Connect FB to the center point of the external resistor divider. The feedback threshold voltage is 0.6V.

**Pin Configuration**

**TSOT23-5  
(Top View)**

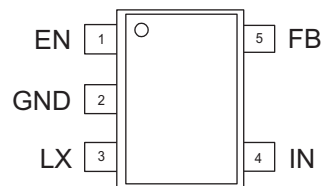

**Absolute Maximum Ratings**

Symbol	Description	Value	Units
$V_{IN}$	Input Supply Voltage	-0.3 to 6.0	V
$V_{EN}, V_{FB}$	EN, FB Voltages	-0.3 to $V_{IN} + 0.3$	
$V_{LX}$	LX Voltages		
$T_J$	Operating Temperature Range	-40 to +85	°C
$T_S$	Storage Temperature Range	-65 to +150	
$T_{LEAD}$	Lead Temperature (soldering, 10s)	300	

**Recommended Operating Conditions**

Symbol	Description	Value	Units
$\Theta_{JA}$	Thermal Resistance (TSOT23-5)	150	°C/W
$P_D$	Maximum Power Dissipation at $T_A = 25^\circ\text{C}$	667	mW

1. Absolute Maximum Ratings are those values beyond which the life of a device may be impaired.
2.  $T_J$  is calculated from the ambient temperature  $T_A$  and power dissipation  $P_D$  according to the following formula:  $T_J = T_A + P_D \cdot \Theta_{JA}$ .
3. Thermal resistance is specified with approximately 1 square inch of 1 oz copper.

# DATA SHEET

# AATI106

## 600mA Step-Down Converter

### Electrical Characteristics

$V_{IN} = V_{EN} = 3.6V$ ,  $T_A = 25^\circ C$ , unless otherwise noted.

Symbol	Description	Conditions	Min	Typ	Max	Units
<b>Step-Down Converter</b>						
$V_{IN}$	Input Voltage Range		2.5		5.5	V
$I_Q$	Input DC Supply Current	Active Mode, $V_{FB} = 0.5V$		270	400	$\mu A$
		Shutdown Mode, $V_{FB} = 0V$ , $V_{IN} = 4.2V$		0.08	1.0	
$V_{FB}$	Regulated Feedback Voltage	$T_A = 25^\circ C$	0.5880	0.6000	0.6120	V
		$T_A = 0^\circ C \leq T_A \leq +85^\circ C$	0.5865		0.6135	
		$T_A = -40^\circ C \leq T_A \leq +85^\circ C$	0.5850		0.6150	
$I_{FB}$	FB Input Bias Current	$V_{FB} = 0.65V$	-30		30	nA
$\frac{\Delta V_{OUT}}{V_{OUT}/\Delta V_{IN}}$	Output Voltage Line Regulation	$V_{IN} = 2.5V$ to $5.5V$ , $I_{OUT} = 10mA$		0.11	0.40	%/V
$\frac{\Delta V_{OUT}}{V_{OUT}/\Delta I_{OUT}}$	Output Voltage Load Regulation	$I_{OUT} = 10mA$ to $600mA$		0.0015		%/mA
$I_{LIM}$	Maximum Output Current	$V_{IN} = 3.0V$	600			mA
$F_{OSC}$	Oscillator Frequency	$V_{FB} = 0.6V$	1.2	1.5	1.8	MHz
$T_S$	Startup Time	From Enable to Output Regulation		100		$\mu s$
$R_{DS(ON)}$	P-Channel MOSFET	$I_{LX} = 300mA$		0.30	0.50	$\Omega$
	N-Channel MOSFET	$I_{LX} = 300mA$		0.20	0.45	
	Peak Inductor Current	$V_{IN} = 3V$ , $V_{FB} = 0.5V$ , Duty Cycle <35%		1.20		A
	Output Over-Voltage Lockout	$\Delta V_{OVL} = V_{OVL} - V_{FB}$		60		mV
$V_{EN(L)}$	Enable Threshold Low				0.4	V
$V_{EN(H)}$	Enable Threshold High		1.4			
$I_{EN}$	Input Low Current		-1.0		1.0	$\mu A$
$T_{SD}$	Over-Temperature Shutdown Threshold			150		$^\circ C$
$T_{HYS}$	Over-Temperature Shutdown Hysteresis			15		

1. 100% production test at +25°C. Specifications over the temperature range are guaranteed by design and characterization.

### Typical Characteristics

**Efficiency vs. Output Current**  
( $V_{OUT} = 2.5V$ ;  $L = 2.2\mu H$ ;  $T_A = 25^\circ C$ )

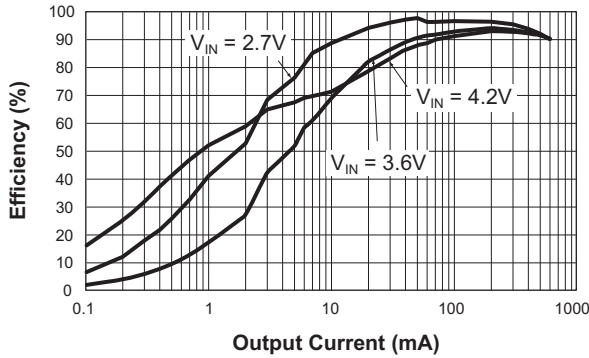

**Efficiency vs. Output Current**  
( $V_{IN} = 3.6V$ ;  $V_{OUT} = 2.5V$ ;  $T_A = 25^\circ C$ )

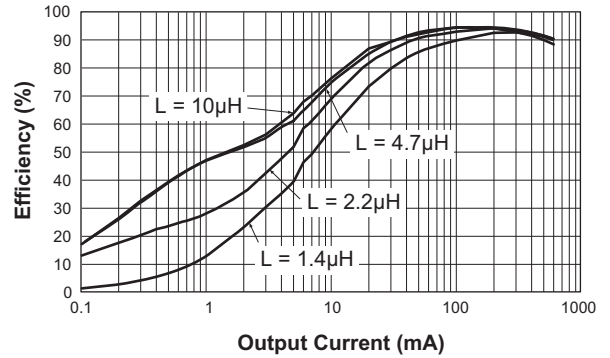

**Efficiency vs. Output Current**  
( $V_{OUT} = 1.8V$ ;  $L = 2.2\mu H$ ;  $T_A = 25^\circ C$ )

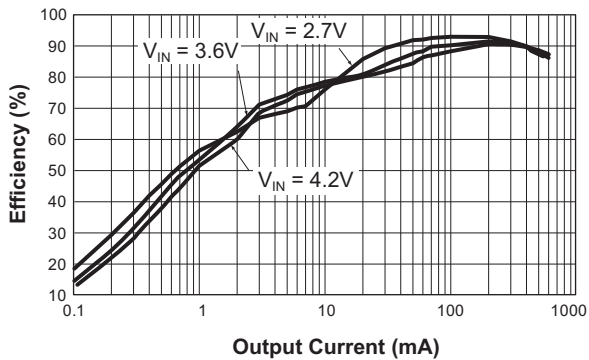

**Efficiency vs. Output Current**  
( $V_{IN} = 3.6V$ ;  $V_{OUT} = 1.8V$ ;  $T_A = 25^\circ C$ )

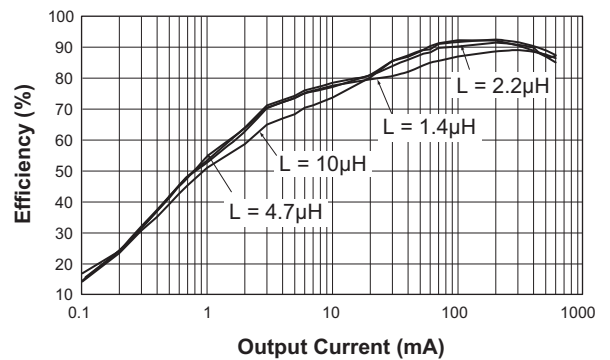

**Efficiency vs. Output Current**  
( $V_{OUT} = 1.5V$ ;  $L = 2.2\mu H$ ;  $T_A = 25^\circ C$ )

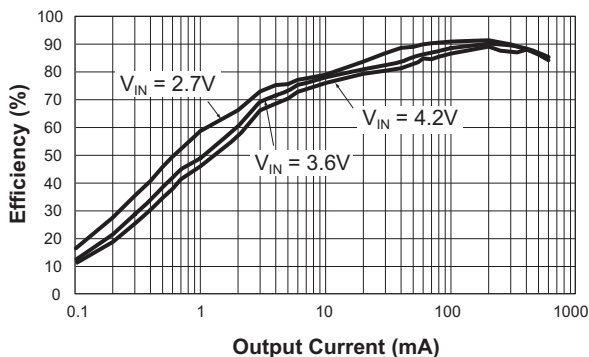

**Efficiency vs. Output Current**  
( $V_{OUT} = 1.2V$ ;  $L = 2.2\mu H$ ;  $T_A = 25^\circ C$ )

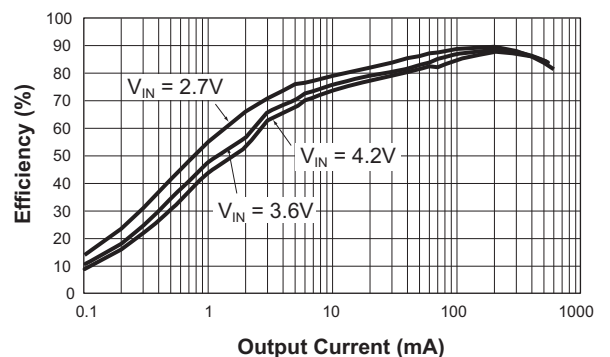

### Typical Characteristics

**Efficiency vs. Input Voltage**  
( $V_{IN} = 3.6V$ ;  $L = 2.2\mu H$ ;  $V_{OUT} = 1.8V$ )

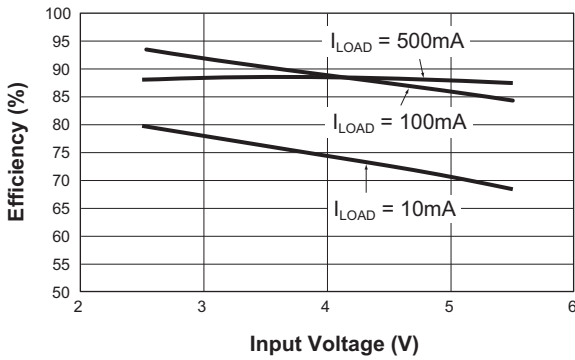

**Output Voltage vs. Output Current**  
( $V_{IN} = 3.6V$ ;  $V_{OUT} = 1.8V$ ;  $L = 2.2\mu H$ )

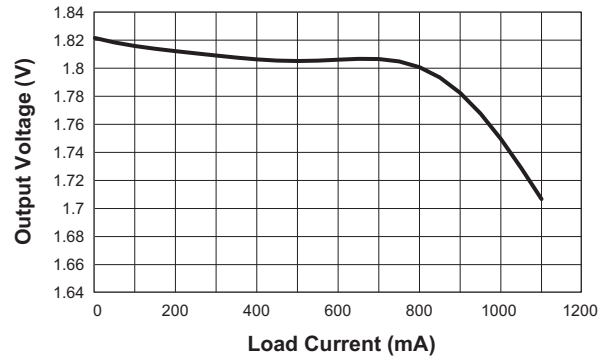

**Frequency vs. Input Voltage**  
( $V_{OUT} = 1.8V$ ;  $I_{LOAD} = 150mA$ ;  $L = 2.2\mu H$ )

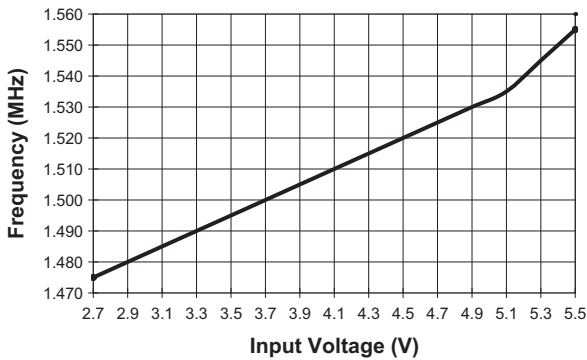

**$R_{DS(ON)}$  vs. Input Voltage**

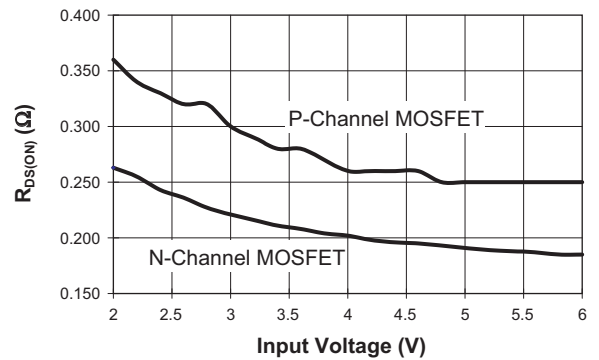

**Feedback Voltage vs. Temperature**  
( $V_{IN} = 3.6V$ )

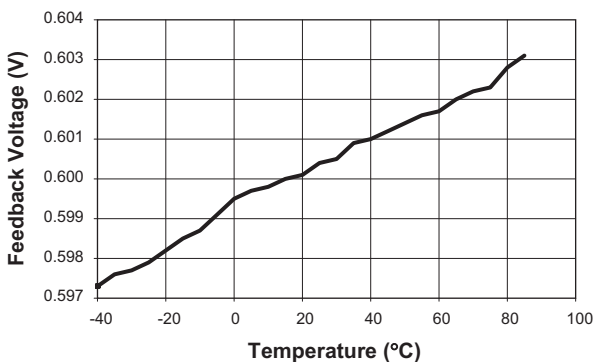

**$R_{DS(ON)}$  vs. Temperature**  
( $V_{IN} = 3.6V$ )

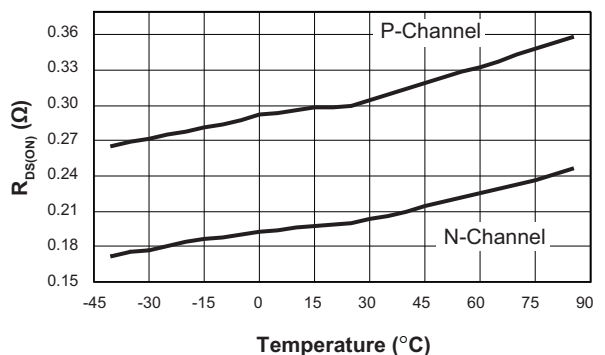

### Typical Characteristics

Frequency vs. Temperature

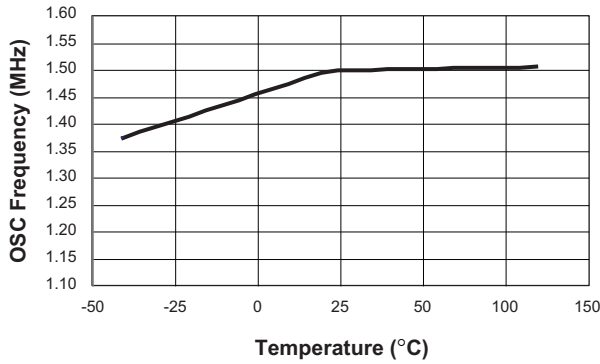

Input Supply Current vs. Temperature

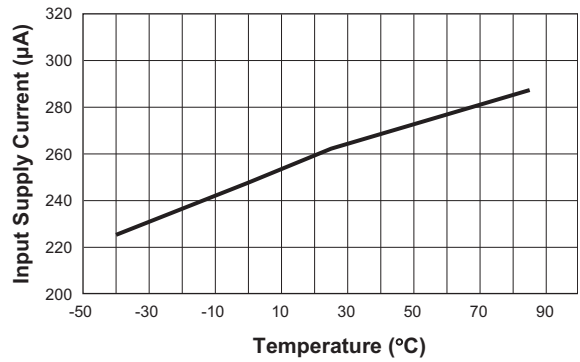

Load Transient Response

(PWM Mode Only;  $I_{LOAD} = 100\text{mA}$  to  $400\text{mA}$ ;  $L = 2.2\mu\text{H}$ ;  $C_{IN} = 10\mu\text{F}$ ;  $C_{OUT} = 10\mu\text{F}$ ;  $V_{IN} = 3.6\text{V}$ ;  $V_{OUT} = 1.8\text{V}$ )

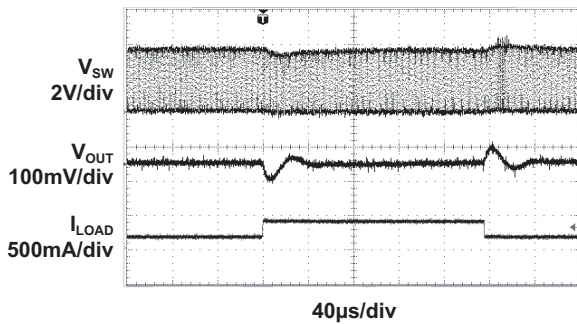

Load Transient Response

(Light Load Mode to PWM Mode;  $I_{LOAD} = 28\text{mA}$  to  $400\text{mA}$ ;  $L = 2.2\mu\text{H}$ ;  $C_{IN} = 10\mu\text{F}$ ;  $C_{OUT} = 10\mu\text{F}$ ;  $V_{IN} = 3.6\text{V}$ ;  $V_{OUT} = 1.8\text{V}$ )

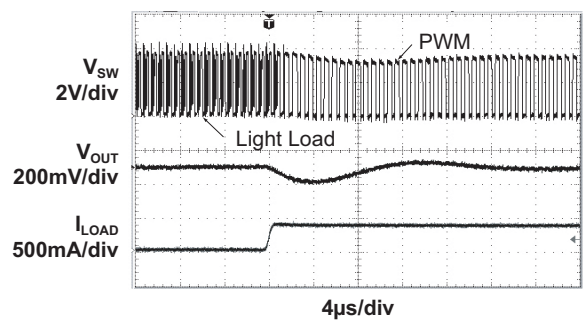

### Typical Characteristics

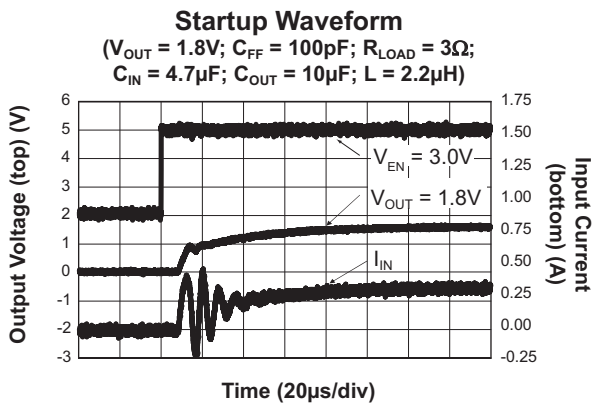
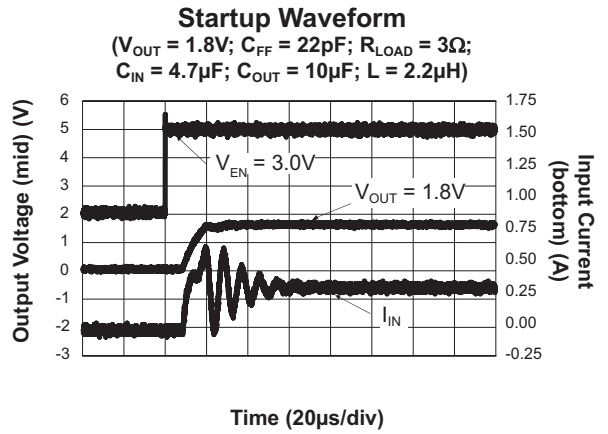
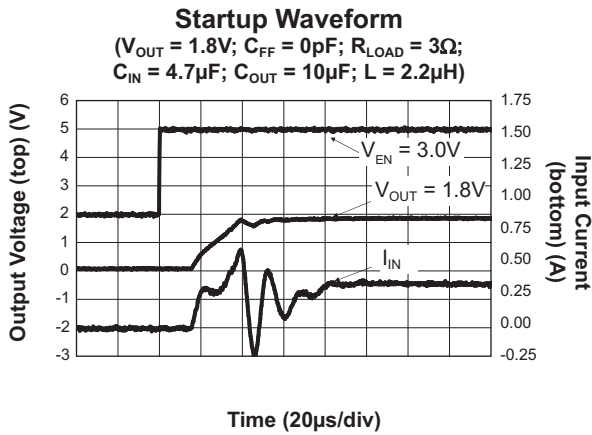



### Functional Block Diagram

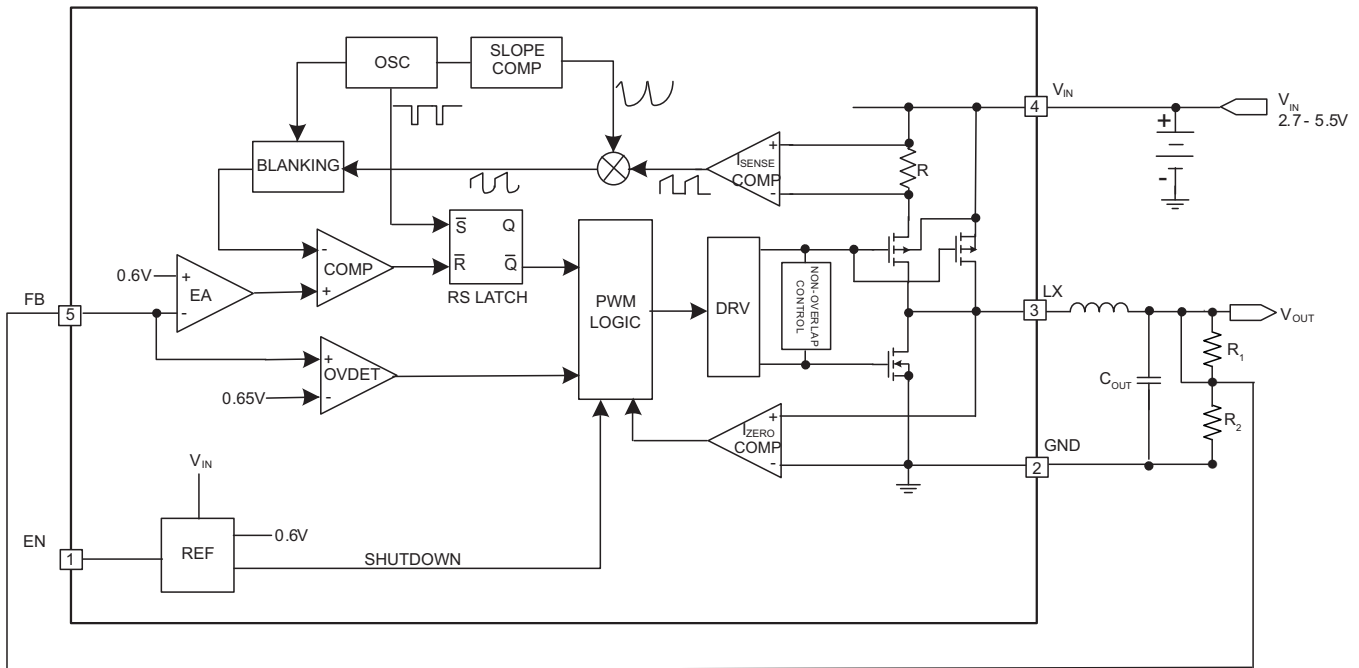

### Functional Description

The AAT1106 is a high performance 600mA, 1.5MHz fixed frequency monolithic switch-mode step-down converter which uses a current mode architecture with an adaptive slope compensation scheme. It minimizes external component size and optimizes efficiency over the complete load range. The adaptive slope compensation allows the device to remain stable over a wider range of inductor values so that smaller values (1 $\mu$ H to 4.7 $\mu$ H) with associated lower DCR can be used to achieve higher efficiency. Apart from the small bypass input capacitor, only a small L-C filter is required at the output. The AAT1106 can be programmed with external feedback to any voltage, ranging from 0.6V to the input voltage. It uses internal MOSFETs to achieve high efficiency and can generate very low output voltage by using an internal reference of 0.6V. At dropout, the converter duty cycle increases to 100% and the output voltage tracks the input voltage minus the low  $R_{DS(ON)}$  drop of the P-channel high-side MOSFET. The input voltage range is 2.5V to 5.5V. The converter efficiency has been optimized for all load condi-

tions, ranging from no load to 600mA at  $V_{IN} = 3V$ . The internal error amplifier and compensation provides excellent transient response, load, and line regulation.

### Current Mode PWM Control

Slope compensated current mode PWM control provides stable switching and cycle-by-cycle current limit for excellent load and line response and protection of the internal main switch (P-channel MOSFET) and synchronous rectifier (N-channel MOSFET). During normal operation, the internal P-channel MOSFET is turned on for a specified time to ramp the inductor current at each rising edge of the internal oscillator, and is switched off when the feedback voltage is above the 0.6V reference voltage. The current comparator,  $I_{COMP}$ , limits the peak inductor current. When the main switch is off, the synchronous rectifier turns on immediately and stays on until either the inductor current starts to reverse, as indicated by the current reversal comparator,  $I_{ZERO}$ , or the beginning of the next clock cycle.

### **Control Loop**

The AAT1106 is a peak current mode step-down converter. The current through the P-channel MOSFET (high side) is sensed for current loop control, as well as short circuit and overload protection. An adaptive slope compensation signal is added to the sensed current to maintain stability for duty cycles greater than 50%. The peak current mode loop appears as a voltage-programmed current source in parallel with the output capacitor. The output of the voltage error amplifier programs the current mode loop for the necessary peak switch current to force a constant output voltage for all load and line conditions. Internal loop compensation terminates the transconductance voltage error amplifier output. For the adjustable output, the error amplifier reference is fixed at 0.6V.

### **Enable**

The enable pin is active high. When pulled low, the enable input forces the AAT1106 into a low-power, non-switching state. The total input current during shutdown is less than 1 $\mu$ A.

### **Current Limit and Over-Temperature Protection**

For overload conditions, the peak input current is limited. To minimize power dissipation and stresses under current limit and short-circuit conditions, switching is terminated after entering current limit for a series of pulses. Switching is terminated for seven consecutive clock cycles after a current limit has been sensed for a series of four consecutive clock cycles. Thermal protection completely disables switching when internal dissipation becomes excessive. The junction over-temperature threshold is 150°C with 15°C of hysteresis. Once an over-temperature or over-current fault conditions is removed, the output voltage automatically recovers.

### **Dropout Operation**

When the input voltage decreases toward the value of the output voltage, the AAT1106 allows the main switch to remain on for more than one switching cycle and increases the duty cycle until it reaches 100%.

The duty cycle D of a step-down converter is defined as:

$$D = T_{ON} \cdot F_{OSC} \cdot 100\% \approx \frac{V_{OUT}}{V_{IN}} \cdot 100\%$$

Where  $T_{ON}$  is the main switch on time and  $F_{OSC}$  is the oscillator frequency (1.5MHz).

The output voltage then is the input voltage minus the voltage drop across the main switch and the inductor. At low input supply voltage, the  $R_{DS(ON)}$  of the P-channel MOSFET increases and the efficiency of the converter decreases. Caution must be exercised to ensure the heat dissipated does not exceed the maximum junction temperature of the IC.

### **Maximum Load Current**

The AAT1106 will operate with an input supply voltage as low as 2.5V; however, the maximum load current decreases at lower input due to the large IR drop on the main switch and synchronous rectifier. The slope compensation signal reduces the peak inductor current as a function of the duty cycle to prevent sub-harmonic oscillations at duty cycles greater than 50%. Conversely, the current limit increases as the duty cycle decreases.

### Applications Information

Figure 1 shows the basic application circuit of AAT1106.

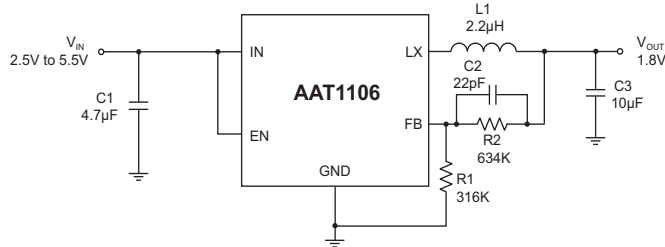

**Figure 1: Basic Application Circuit**

### Setting the Output Voltage

For applications requiring an adjustable output voltage, the AAT1106-0.6 can be externally programmed. Resistors R1 and R2 of Figure 2 program the output to regulate at a voltage higher than 0.6V. To limit the bias current required for the external feedback resistor string while maintaining good noise immunity, the minimum suggested value for R1 is 59kΩ. Although a larger value will further reduce quiescent current, it will also increase the impedance of the feedback node, making it more sensitive to external noise and interference. Table 1 summarizes the resistor values for various output voltages with R1 set to either 59kΩ for good noise immunity or 316kΩ for reduced no load input current.

The AAT1106, combined with an external feed forward capacitor (C2 in Figure 2), delivers enhanced transient response for extreme pulsed load applications. The addition of the feed forward capacitor typically requires a larger output capacitor C3 for stability. The external resistor sets the output voltage according to the following equation:

$$V_{OUT} = 0.6V \cdot \left(1 + \frac{R2}{R1}\right)$$

or

$$R2 = \left[\left(\frac{V_{OUT}}{0.6V} - 1\right)\right] \cdot R1$$

V <sub>OUT</sub> (V)	R1 = 59kΩ	R1 = 316kΩ
	R2 (kΩ)	R2 (kΩ)
0.8	19.6	105
0.9	29.4	158
1.0	39.2	210
1.1	49.9	261
1.2	59.0	316
1.3	68.1	365
1.4	78.7	422
1.5	88.7	475
1.8	118	634
1.85	124	655
2.0	137	732
2.5	187	1000
3.3	267	1430

**Table 1: Resistor Selection for Output Voltage Setting; Standard 1% Resistor Values Substituted Closest to the Calculated Values.**

### Inductor Selection

For most designs, the AAT1106 operates with inductor values of 1µH to 4.7µH. Low inductance values are physically smaller, but require faster switching, which results in some efficiency loss. The inductor value can be derived from the following equation:

$$L = \frac{V_{OUT} \cdot (V_{IN} - V_{OUT})}{V_{IN} \cdot \Delta I_L \cdot f_{OSC}}$$

Where  $\Delta I_L$  is inductor ripple current. Large value inductors lower ripple current and small value inductors result in high ripple currents. Choose inductor ripple current approximately 35% of the maximum load current 600mA, or  $\Delta I_L = 210mA$ .

## 600mA Step-Down Converter

Part	L (μH)	Max DCR (mΩ)	Rated DC Current (A)	Size WxLxH (mm)
Sumida CR43	1.4	56.2	2.52	4.5x4.0x3.5
	2.2	71.2	1.75	
	3.3	86.2	1.44	
	4.7	108.7	1.15	
Sumida CDRH4D18	1.0	4.5	1.72	4.7x4.7x2.0
	2.2	75	1.32	
	3.3	110	1.04	
	4.7	162	0.84	
Toko D312C	1.5	120	1.29	3.6x3.6x1.2
	2.2	140	1.14	
	3.3	180	0.98	
	4.7	240	0.79	

**Table 2: Typical Surface Mount Inductors.**

For output voltages above 2.0V, when light-load efficiency is important, the minimum recommended inductor size is 2.2μH. For optimum voltage-positioning load transients, choose an inductor with DC series resistance in the 50mΩ to 150mΩ range. For higher efficiency at heavy loads (above 200mA), or minimal load regulation (with some transient overshoot), the resistance should be kept below 100mΩ. The DC current rating of the inductor should be at least equal to the maximum load current plus half the ripple current to prevent core saturation (600mA + 105mA). Table 2 lists some typical surface mount inductors that meet target applications for the AAT1106.

Manufacturer's specifications list both the inductor DC current rating, which is a thermal limitation, and the peak current rating, which is determined by the saturation characteristics. The inductor should not show any appreciable saturation under normal load conditions. Some inductors may meet the peak and average current ratings yet result in excessive losses due to a high DCR. Always consider the losses associated with the DCR and its effect on the total converter efficiency when selecting an inductor. For example, the 2.2μH CR43 series inductor selected from Sumida has a 71.2mΩ DCR and a 1.75ADC current rating. At full load, the inductor DC loss is 25mW which gives a 2.8% loss in efficiency for a 600mA, 1.5V output.

### Slope Compensation

The AAT1106 step-down converter uses peak current mode control with a unique adaptive slope compensation scheme to maintain stability with lower value inductors

for duty cycles greater than 50%. Using lower value inductors provides better overall efficiency and also makes it easier to standardize on one inductor for different required output voltage levels. In order to do this and keep the step-down converter stable when the duty cycle is greater than 50%, the AAT1106 separates the slope compensation into 2 phases. The required slope compensation is automatically detected by an internal circuit using the feedback voltage  $V_{FB}$  before the error amp comparison to  $V_{REF}$ .

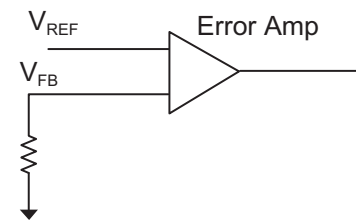

When below 50% duty cycle, the slope compensation is 0.284A/μs; but when above 50% duty cycle, the slope compensation is set to 1.136A/μs. The output inductor value must be selected so the inductor current down slope meets the internal slope compensation requirements.

Below 50% duty cycle, the slope compensation requirement is:

$$m = \frac{1.25}{2 \cdot L} = 0.284A/\mu s$$

Therefore:

$$L = \frac{0.625}{m} = 2.2\mu H$$

Above 50% duty cycle,

$$m = \frac{5}{2 \cdot L} = 1.136A/\mu s$$

Therefore:

$$L = \frac{2.5}{m} = 2.2\mu H$$

With these adaptive settings, a 2.2μH inductor can be used for all output voltages from 0.6V to 5V.

### Input Capacitor Selection

The input capacitor reduces the surge current drawn from the input and switching noise from the device. The input capacitor impedance at the switching frequency shall be less than the input source impedance to prevent high frequency switching current passing to the input. A low ESR input capacitor sized for maximum RMS current must be used. Ceramic capacitors with X5R or X7R dielectrics are highly recommended because of their low ESR and small temperature coefficients. A 4.7μF ceramic capacitor is sufficient for most applications.

To estimate the required input capacitor size, determine the acceptable input ripple level ( $V_{PP}$ ) and solve for C. The calculated value varies with input voltage and is a maximum when  $V_{IN}$  is double the output voltage.

$$C_{IN} = \frac{\frac{V_O}{V_{IN}} \cdot \left(1 - \frac{V_O}{V_{IN}}\right)}{\left(\frac{V_{PP}}{I_O} - ESR\right) \cdot F_S}$$

$$\frac{V_O}{V_{IN}} \cdot \left(1 - \frac{V_O}{V_{IN}}\right) = \frac{1}{4} \text{ for } V_{IN} = 2 \cdot V_O$$

$$C_{IN(MIN)} = \frac{1}{\left(\frac{V_{PP}}{I_O} - ESR\right) \cdot 4 \cdot F_S}$$

Always examine the ceramic capacitor DC voltage coefficient characteristics when selecting the proper value. For example, the capacitance of a 10μF, 6.3V, X5R ceramic capacitor with 5.0V DC applied is actually about 6μF.

The maximum input capacitor RMS current is:

$$I_{RMS} = I_O \cdot \sqrt{\frac{V_O}{V_{IN}} \cdot \left(1 - \frac{V_O}{V_{IN}}\right)}$$

The input capacitor RMS ripple current varies with the input and output voltage and will always be less than or equal to half of the total DC load current:

$$\sqrt{\frac{V_O}{V_{IN}} \cdot \left(1 - \frac{V_O}{V_{IN}}\right)} = \sqrt{D \cdot (1 - D)} = \sqrt{0.5^2} = \frac{1}{2}$$

for  $V_{IN} = 2 \cdot V_O$ .

$$I_{RMS(MAX)} = \frac{I_O}{2}$$

The term  $\frac{V_O}{V_{IN}} \cdot \left(1 - \frac{V_O}{V_{IN}}\right)$  appears in both the input voltage ripple and input capacitor RMS current equations and is at maximum when  $V_O$  is twice  $V_{IN}$ . This is why the input voltage ripple and the input capacitor RMS current ripple are a maximum at 50% duty cycle. The input capacitor provides a low impedance loop for the edges of pulsed current drawn by the AAT1106. Low ESR/ESL X7R and X5R ceramic capacitors are ideal for this function. To minimize stray inductance, the capacitor should be placed as closely as possible to the IC. This keeps the high frequency content of the input current localized, minimizing EMI and input voltage ripple. The proper placement of the input capacitor (C1) can be seen in the evaluation board layout in Figure 2. A laboratory test set-up typically consists of two long wires running from the bench power supply to the evaluation board input voltage pins. The inductance of these wires, along with the low-ESR ceramic input capacitor, can create a high Q network that may affect converter performance. This problem often becomes apparent in the form of excessive ringing in the output voltage during load transients. Errors in the loop phase and gain measurements can also result. Since the inductance of a short PCB trace feeding the input voltage is significantly lower than the power leads from the bench power supply, most applications do not exhibit this problem. In applications where the input power source lead inductance cannot be reduced to a level that does not affect the converter performance, a high ESR tantalum or aluminum electrolytic should be placed in parallel with the low ESR, ESL bypass ceramic. This dampens the high Q network and stabilizes the system.

### Output Capacitor Selection

The output capacitor is required to keep the output voltage ripple small and to ensure regulation loop stability. The output capacitor must have low impedance at the switching frequency. Ceramic capacitors with X5R or X7R dielectrics are recommended due to their low ESR and high ripple current. The output ripple  $V_{OUT}$  is determined by:

$$\Delta V_{OUT} \leq \frac{V_{OUT} \cdot (V_{IN} - V_{OUT})}{V_{IN} \cdot f_{OSC} \cdot L} \cdot \left( ESR + \frac{1}{8 \cdot f_{OSC} \cdot C3} \right)$$

The output capacitor limits the output ripple and provides holdup during large load transitions. A 4.7μF to

## 600mA Step-Down Converter

10µF X5R or X7R ceramic capacitor typically provides sufficient bulk capacitance to stabilize the output during large load transitions and has the ESR and ESL characteristics necessary for low output ripple. The output voltage droop due to a load transient is dominated by the capacitance of the ceramic output capacitor. During a step increase in load current, the ceramic output capacitor alone supplies the load current until the loop responds. Within two or three switching cycles, the loop responds and the inductor current increases to match the load current demand. The relationship of the output voltage droop during the three switching cycles to the output capacitance can be estimated by:

$$C_{OUT} = \frac{3 \cdot \Delta I_{LOAD}}{V_{DROOP} \cdot F_S}$$

Once the average inductor current increases to the DC load level, the output voltage recovers. The above equation establishes a limit on the minimum value for the output capacitor with respect to load transients. The internal voltage loop compensation also limits the minimum output capacitor value to 4.7µF. This is due to its effect on the loop crossover frequency (bandwidth), phase margin, and gain margin. Increased output capacitance will reduce the crossover frequency with greater phase margin.

The maximum output capacitor RMS ripple current is given by:

$$I_{RMS(MAX)} = \frac{1}{2 \cdot \sqrt{3}} \cdot \frac{V_{OUT} \cdot (V_{IN(MAX)} - V_{OUT})}{L \cdot F \cdot V_{IN(MAX)}}$$

Dissipation due to the RMS current in the ceramic output capacitor ESR is typically minimal, resulting in less than a few degrees rise in hot-spot temperature.

### Thermal Calculations

There are three types of losses associated with the AAT1106 step-down converter: switching losses, conduction losses, and quiescent current losses. Conduction losses are associated with the  $R_{DS(ON)}$  characteristics of the power output switching devices. Switching losses are dominated by the gate charge of the power output switching devices. At full load, assuming continuous conduction mode (CCM), a simplified form of the losses is given by:

$$P_{TOTAL} = \frac{I_O^2 \cdot (R_{DS(ON)} \cdot V_O + R_{DS(ON)} \cdot [V_{IN} - V_O])}{V_{IN}} + (t_{sw} \cdot F \cdot I_O + I_Q) \cdot V_{IN}$$

$I_Q$  is the step-down converter quiescent current. The term  $t_{sw}$  is used to estimate the full load step-down converter switching losses.

For the condition where the step-down converter is in dropout at 100% duty cycle, the total device dissipation reduces to:

$$P_{TOTAL} = I_O^2 \cdot R_{DS(ON)} + I_Q \cdot V_{IN}$$

Since  $R_{DS(ON)}$ , quiescent current, and switching losses all vary with input voltage, the total losses should be investigated over the complete input voltage range. Given the total losses, the maximum junction temperature can be derived from the  $\theta_{JA}$  for the TSOT23-5 package which is 150°C/W.

$$T_{J(MAX)} = P_{TOTAL} \cdot \theta_{JA} + T_A$$

### Layout Guidance

When laying out the PC board, the following steps should be taken to ensure proper operation of the AAT1106. These items are also illustrated graphically in Figure 3.

1. The power traces (GND, LX, IN) should be kept short, direct, and wide to allow large current flow. Place sufficient multiple-layer pads when needed to change the trace layer.
2. The input capacitor (C1) should connect as closely as possible to IN (Pin 4) and GND (Pin 2).
3. The output capacitor C3 and L1 should be connected as closely as possible. The connection of L1 to the LX pin should be as short as possible and there should not be any signal lines under the inductor.
4. The feedback FB trace (Pin 5) should be separate from any power trace and connect as closely as possible to the load point. Sensing along a high-current load trace will degrade DC load regulation. The external feedback resistors should be placed as close as possible to the FB pin (Pin 5) to minimize the length of the high impedance feedback trace.
5. The resistance of the trace from the load return to the GND (Pin 2) should be kept to a minimum. This will help to minimize any error in DC regulation due to differences in the potential of the internal signal ground and the power ground.



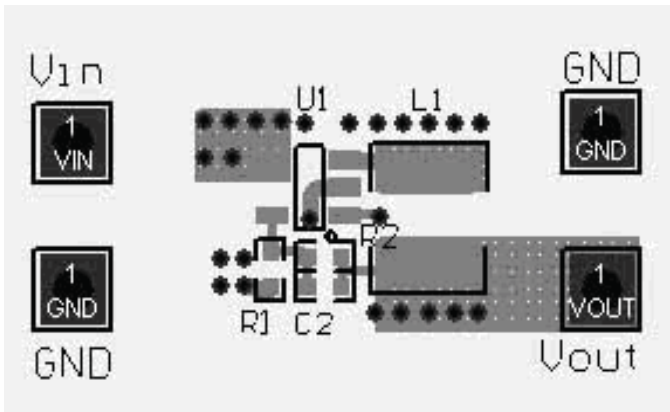

a: Top Layer

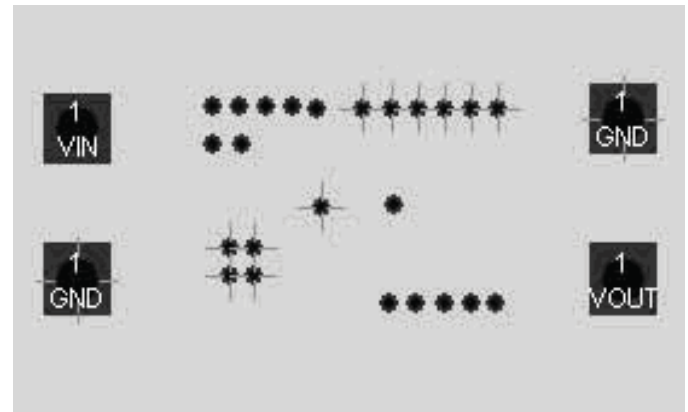

b: Internal GND Plane

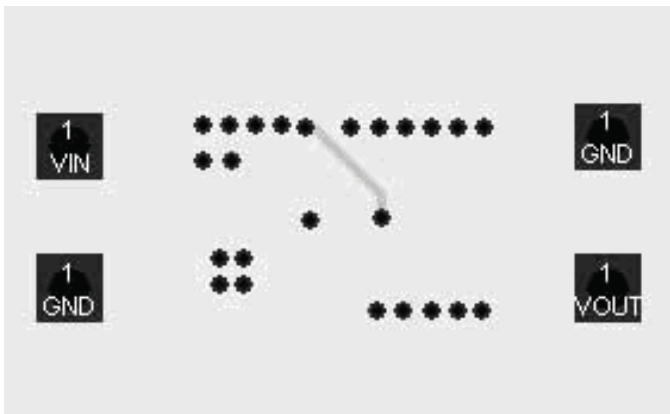

c: Bottom Layer

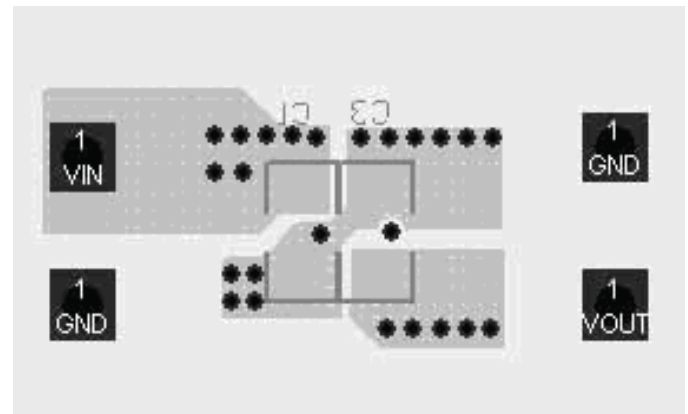

d: Middle Layer

Figure 2: AAT1106 Four-Layer Layout Example with Internal GND Plane.

## Evaluation Board Description

The AAT1106 evaluation board contains a fully tested 600mA, 1.5MHz Step-Down DC/DC Regulator. The circuit has an input voltage range of 2.5V to 5.5V and four pre-set selectable outputs (1.2V, 1.5V, 1.8V and 2.5V).

The AAT1106 comes in a small 5-pin TSOT23 package and the board has been optimized to fit small form factor designs. An optional TVS (SM6T6V8A) is connected

between VIN and GND so that the evaluation board can be used in a hot-plug application. These features, plus the nominal operating frequency of 1.5MHz allowing the use of low profile surface mount components, make the AAT1106 evaluation board an ideal circuit for use in battery-powered, hand-held applications.

A schematic of the complete circuit is shown in Figure 3. The evaluation board layer details are provided in Figures 4, 5, 6 and 7. Table 3 provides the component list for the AAT1106 evaluation board.

# DATA SHEET

# AAT1106

## 600mA Step-Down Converter

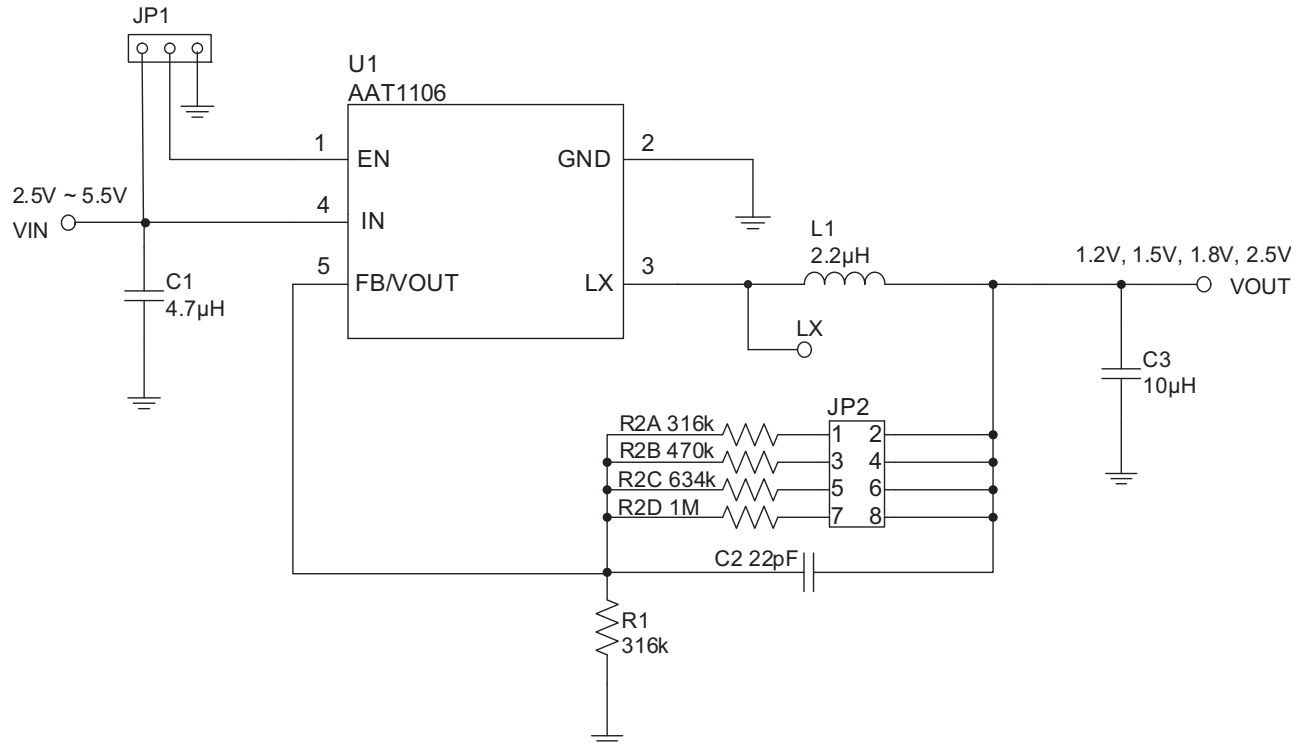

**Figure 3: AAT1106 Evaluation Board Schematic.**

Component	Part#	Description	Manufacturer
U1	AAT1106	1.5 MHz, 600mA Synchronous Step-Down Converter	Skyworks
L1	SF32-2R2M-R	INDUCTOR 2.2µH 1.8A SMD	Fenfa
C1	GRM42-6X7R475K16PT	CAP CERAMIC 4.7µF16V X7R 10% 1206	MURATA
C2	C1005COG1H220JT000P	CAP CERAMIC 22pF 50V C0G 5% 0402	TDK
C3	GRM31BR71C106KA01L	CAP CERAMIC 10µF 16V X7R 10% 1206	MURATA
R1, R2A	Chip Resistor	RES 316kΩ 1/16W 1% 0402 SMD	
R2B	Chip Resistor (optional)	RES 470kΩ 1/16W 1% 0402 SMD	
R2C	Chip Resistor (optional)	RES 634kΩ 1/16W 1% 0402 SMD	
R2D	Chip Resistor (optional)	RES 1MΩ 1/16W 1% 0402 SMD	
No Designator	SM6T6V8A (optional)	6.8V TVS	ST

**Table 3: AAT1106 Evaluation Board Component Listing.**



# DATA SHEET

# AAT1106

## 600mA Step-Down Converter

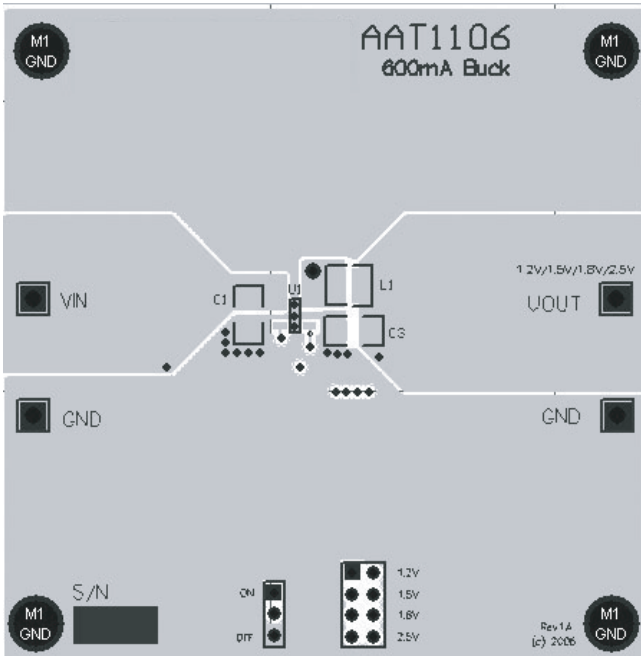

Figure 4: PCB Top Side.

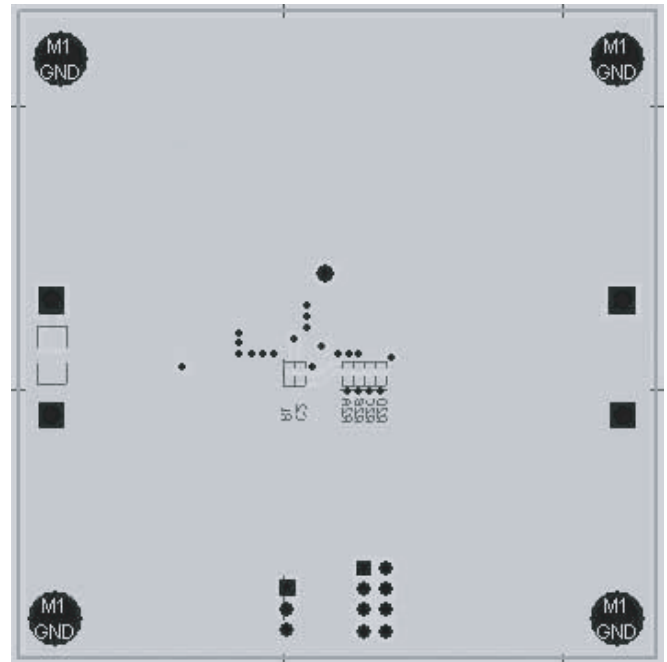

Figure 5: PCB Bottom Side.

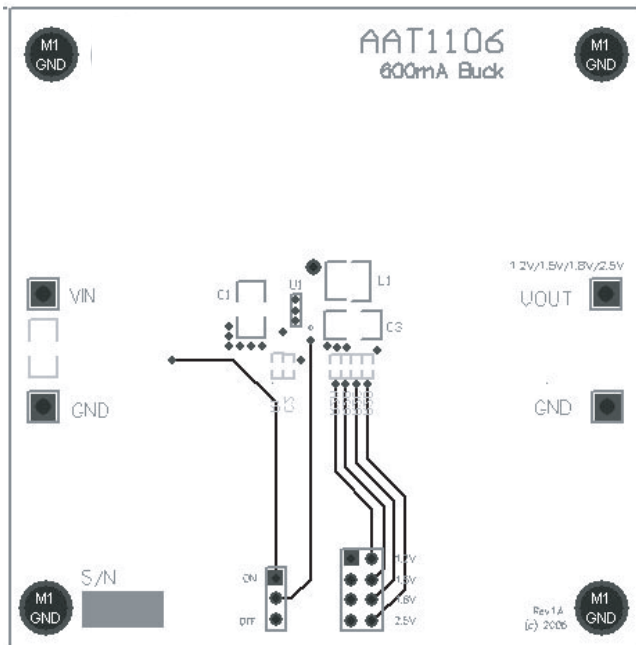

Figure 6: PCB Midlayer 1 Side.

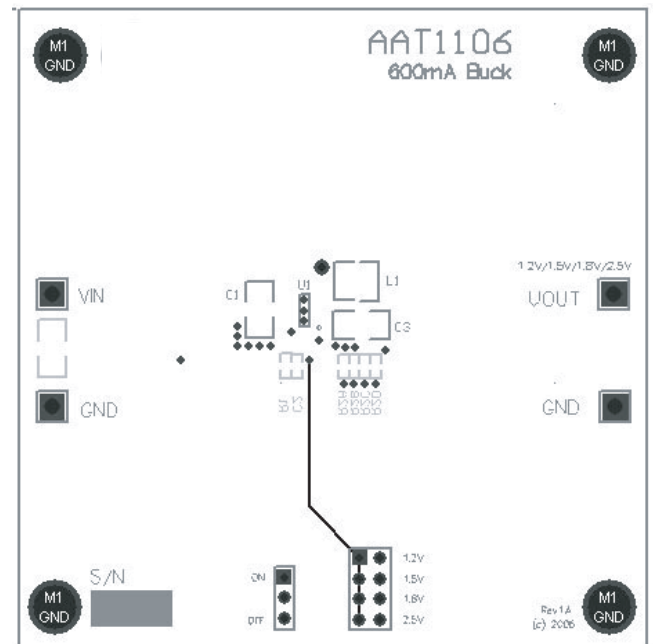

Figure 7: PCB Midlayer 2 Side.

### Ordering Information

Output Voltage	Package	Marking <sup>1</sup>	Part Number (Tape & Reel) <sup>2</sup>
Adj. 0.6 to $V_{IN}$	TSOT23-5	VVXY	<b>AAT1106ICB-0.6-T1</b>



Skyworks Green™ products are compliant with all applicable legislation and are halogen-free. For additional information, refer to *Skyworks Definition of Green™*, document number SQ04-0074.

### Package Information<sup>3</sup>

#### TSOT23-5

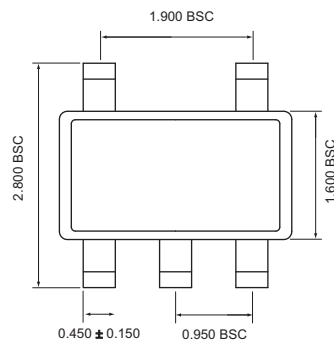

Top View

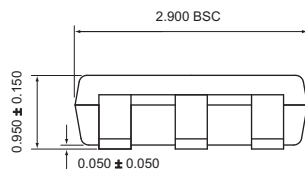

Side View

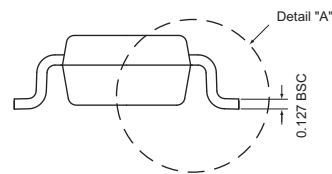

End View

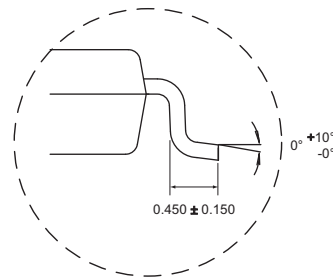

Detail "A"

All dimensions in millimeters.

1. XYY = assembly and date code.  
 2. Sample stock is generally held on part numbers listed in **BOLD**.  
 3. Package outline exclusive of mold flash and metal burr.

# DATA SHEET

# AAT1106

## 600mA Step-Down Converter

Copyright © 2012, 2013 Skyworks Solutions, Inc. All Rights Reserved.

Information in this document is provided in connection with Skyworks Solutions, Inc. ("Skyworks") products or services. These materials, including the information contained herein, are provided by Skyworks as a service to its customers and may be used for informational purposes only by the customer. Skyworks assumes no responsibility for errors or omissions in these materials or the information contained herein. Skyworks may change its documentation, products, services, specifications or product descriptions at any time, without notice. Skyworks makes no commitment to update the materials or information and shall have no responsibility whatsoever for conflicts, incompatibilities, or other difficulties arising from any future changes.

No license, whether express, implied, by estoppel or otherwise, is granted to any intellectual property rights by this document. Skyworks assumes no liability for any materials, products or information provided hereunder, including the sale, distribution, reproduction or use of Skyworks products, information or materials, except as may be provided in Skyworks Terms and Conditions of Sale.

THE MATERIALS, PRODUCTS AND INFORMATION ARE PROVIDED "AS IS" WITHOUT WARRANTY OF ANY KIND, WHETHER EXPRESS, IMPLIED, STATUTORY, OR OTHERWISE, INCLUDING FITNESS FOR A PARTICULAR PURPOSE OR USE, MERCHANTABILITY, PERFORMANCE, QUALITY OR NON-INFRINGEMENT OF ANY INTELLECTUAL PROPERTY RIGHT; ALL SUCH WARRANTIES ARE HEREBY EXPRESSLY DISCLAIMED. SKYWORKS DOES NOT WARRANT THE ACCURACY OR COMPLETENESS OF THE INFORMATION, TEXT, GRAPHICS OR OTHER ITEMS CONTAINED WITHIN THESE MATERIALS. SKYWORKS SHALL NOT BE LIABLE FOR ANY DAMAGES, INCLUDING BUT NOT LIMITED TO ANY SPECIAL, INDIRECT, INCIDENTAL, STATUTORY, OR CONSEQUENTIAL DAMAGES, INCLUDING WITHOUT LIMITATION, LOST REVENUES OR LOST PROFITS THAT MAY RESULT FROM THE USE OF THE MATERIALS OR INFORMATION, WHETHER OR NOT THE RECIPIENT OF MATERIALS HAS BEEN ADVISED OF THE POSSIBILITY OF SUCH DAMAGE.

Skyworks products are not intended for use in medical, lifesaving or life-sustaining applications, or other equipment in which the failure of the Skyworks products could lead to personal injury, death, physical or environmental damage. Skyworks customers using or selling Skyworks products for use in such applications do so at their own risk and agree to fully indemnify Skyworks for any damages resulting from such improper use or sale.

Customers are responsible for their products and applications using Skyworks products, which may deviate from published specifications as a result of design defects, errors, or operation of products outside of published parameters or design specifications. Customers should include design and operating safeguards to minimize these and other risks. Skyworks assumes no liability for applications assistance, customer product design, or damage to any equipment resulting from the use of Skyworks products outside of stated published specifications or parameters.

Skyworks, the Skyworks symbol, and "Breakthrough Simplicity" are trademarks or registered trademarks of Skyworks Solutions, Inc., in the United States and other countries. Third-party brands and names are for identification purposes only, and are the property of their respective owners. Additional information, including relevant terms and conditions, posted at [www.skyworksinc.com](http://www.skyworksinc.com), are incorporated by reference.