

FEATURES

- * Designed for ease in circuit board assembly.
- * Black case enhance contrast ratio.
- * Solid state light source.
- * Reliable and rugged.

PACKAGE DIMENSIONS

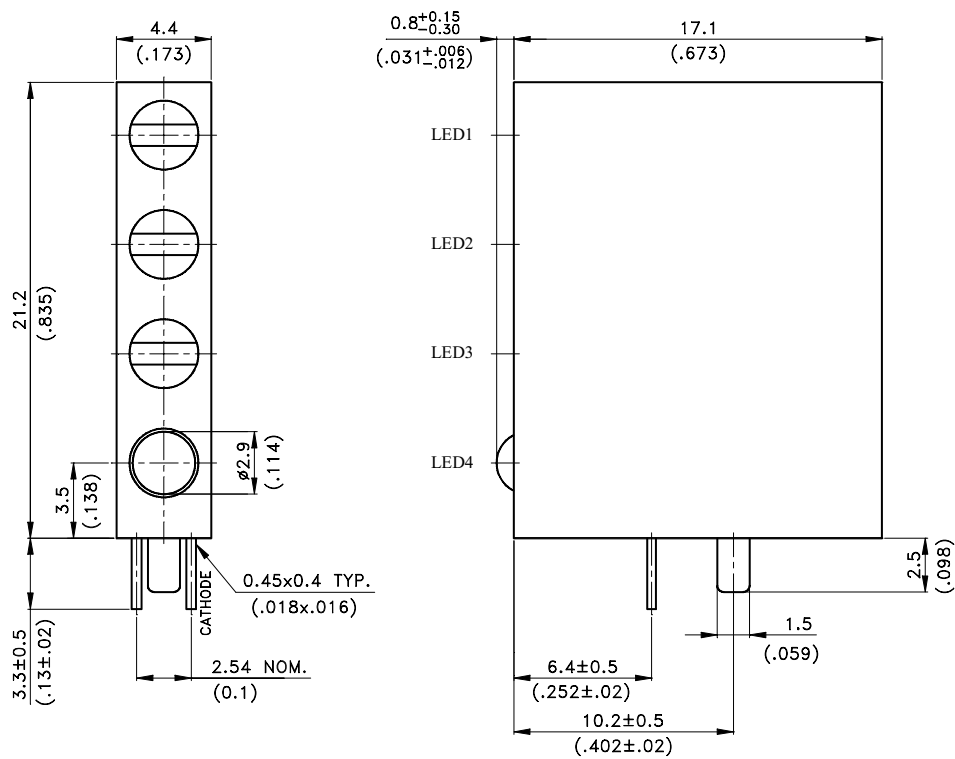

Lamp Part No.	Lens	Source Color
LTL-4231N	Green Diffused	Green

NOTES:

1. All dimensions are in millimeters (inches).
2. Tolerance is $\pm 0.25\text{mm}(.010\text{'})$ unless otherwise noted.
3. The holder color is black.
4. LED1~LED3 lamps are empty
LED4 lamp is LTL-4231N.
5. Specifications are subject to change without notice.



ABSOLUTE MAXIMUM RATINGS AT Ta=25°C

Parameter	Maximum Rating	Unit
Power Dissipation	100	mW
Peak Forward Current (1/10 Duty Cycle, 0.1ms Pulse Width)	120	mA
Continuous Forward Current	30	mA
Derating Linear From 50°C	0.4	mA/°C
Reverse Voltage	5	V
Operating Temperature Range	-55°C to + 100°C	
Storage Temperature Range	-55°C to + 100°C	
Lead Soldering Temperature [1.6mm(.063") From Body]	260°C for 5 Seconds	



ABSOLUTE MAXIMUM RATINGS AT Ta=25°C

Parameter	Symbol	Part No. LTL-	Min.	Typ.	Max.	Unit	Test Condition
Luminous Intensity	I _v	42M2NH36P	3.7	12.6		mcd	I _F = 10mA Note 1,4
Viewing Angle	2θ _{1/2}	42M2NH36P		60		deg	Note 2 (Fig.6)
Peak Emission Wavelength	λ _p	42M2NH36P		565		nm	Measurement @Peak (Fig.1)
Dominant Wavelength	λ _d	42M2NH36P		569		nm	Note 3
Spectral Line Half-Width	Δλ	42M2NH36P		30		nm	
Forward Voltage	V _F	42M2NH36P		2.1	2.6	V	I _F = 20mA
Reverse Current	I _R	42M2NH36P			100	μA	V _R = 5V
Capacitance	C	42M2NH36P		35		pF	V _F = 0 , f = 1MHz

- Note:
1. Luminous intensity is measured with a light sensor and filter combination that approximates the CIE eye-response curve.
 2. θ_{1/2} is the off-axis angle at which the luminous intensity is half the axial luminous intensity.
 3. The dominant wavelength, λ_d is derived from the CIE chromaticity diagram and represents the single wavelength which defines the color of the device.
 4. I_v needs ±15% additional for guaranteed limits.

TYPICAL ELECTRICAL / OPTICAL CHARACTERISTICS CURVES

(25°C Ambient Temperature Unless Otherwise Noted)

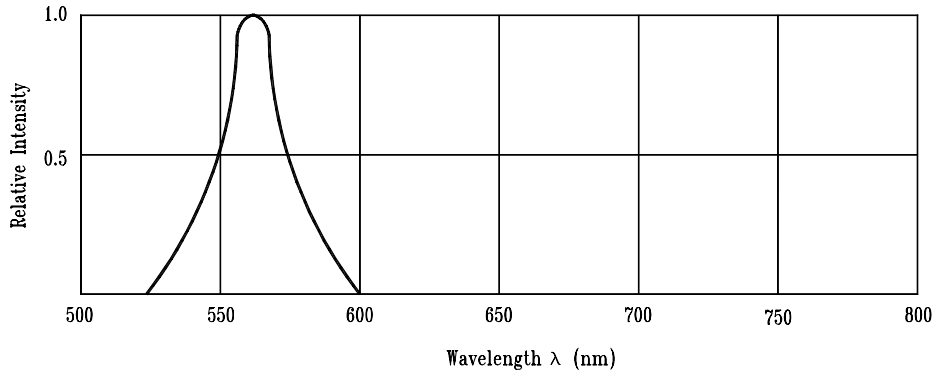

Fig.1 Relative Intensity vs. Wavelength

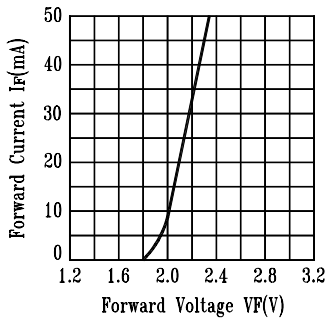

Fig.2 Forward Current vs. Forward Voltage

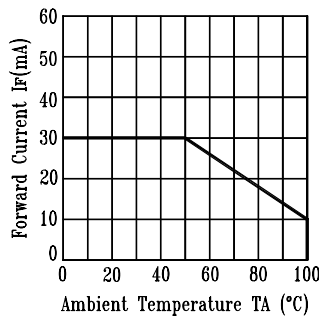

Fig.3 Forward Current Derating Curve

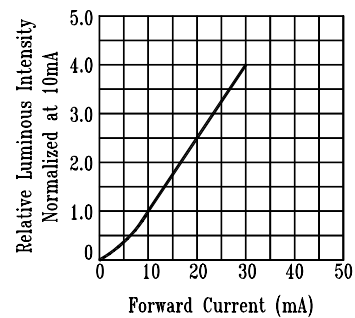

Fig.4 Relative Luminous Intensity vs. Forward Current

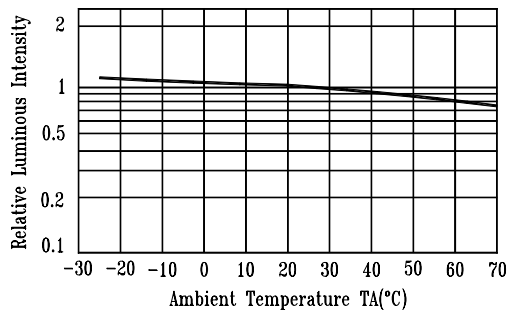

Fig.5 Luminous Intensity vs. Ambient Temperature

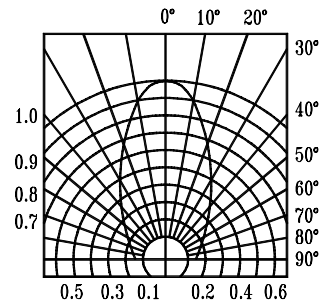

Fig.6 Spatial Distribution