

Spezifikation für Freigabe / specification for release

Kunde / customer : _____
 Artikelnummer / part number : **744778112**
 Bezeichnung : **SPEICHERDROSSEL WE-PD**
 description : **POWER-CHOKE WE-PD**



DATUM / DATE : 2004-10-11

H Induktivitätskurve / Inductance curve :

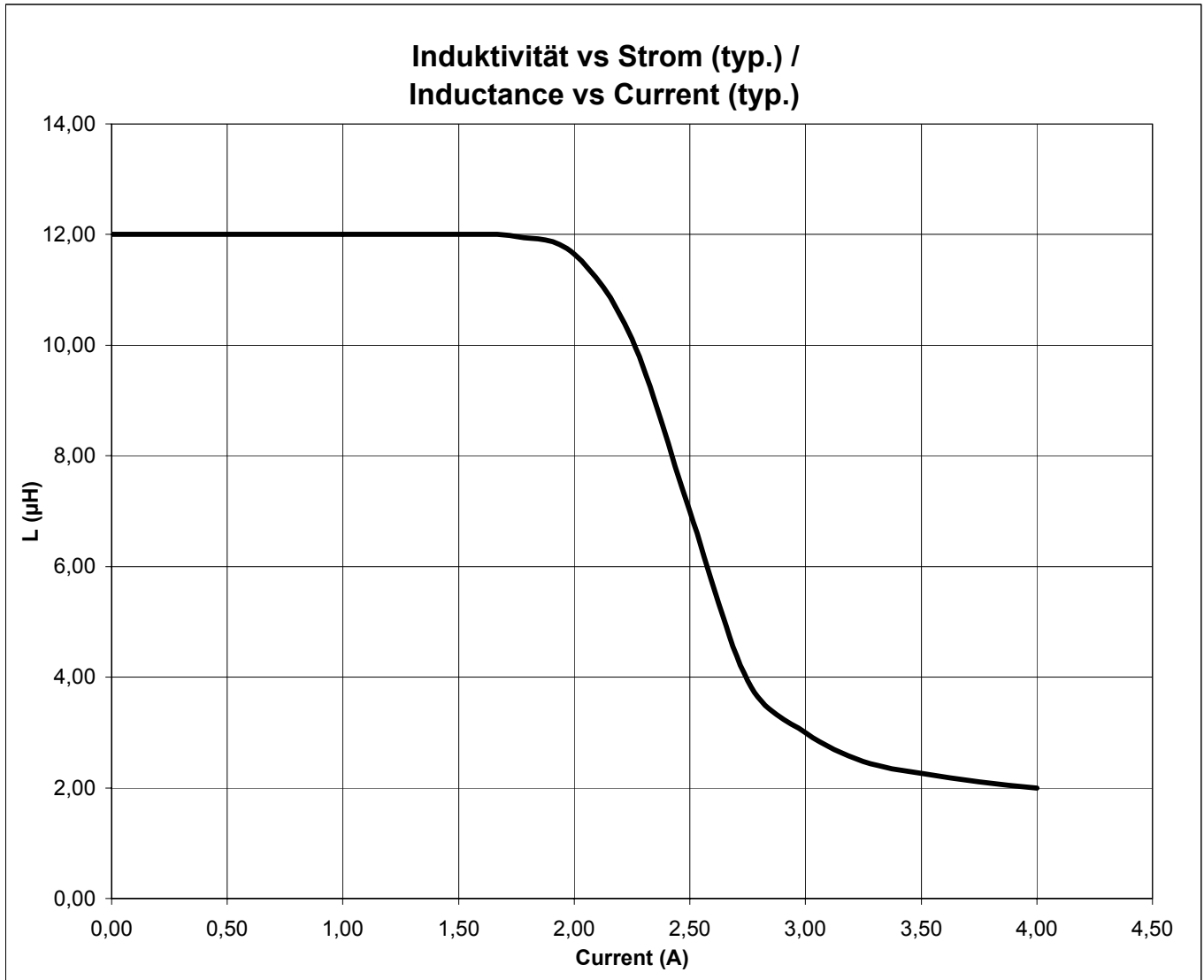

Freigabe erteilt / general release:	Kunde / customer			
Datum / date	Unterschrift / signature	MST	Version 5	04-10-11
	Würth Elektronik	MST	Version 4	03-12-10
Geprüft / checked	Kontrolliert / approved	RT	Version 3	03-02-24
		MST	Version 2	02-02-27
		JH	Version 1	00-12-06
		Name	Änderung / modification	Datum / date

Würth Elektronik eiSos GmbH & Co. KG

D-74638 Waldenburg · Max-Eyth-Strasse 1 - 3 · Germany · Telefon (+49) (0) 7942 - 945 - 0 · Telefax (+49) (0) 7942 - 945 - 400
<http://www.we-online.de>

Spezifikation für Freigabe / specification for release

Kunde / customer :
 Artikelnummer / part number : **744778112**
 Bezeichnung : **SPEICHERDROSSEL WE-PD**
 description : **POWER-CHOKE WE-PD**



DATUM / DATE : 2004-10-11

I Rollenspezifikation / Tape and reel specification :

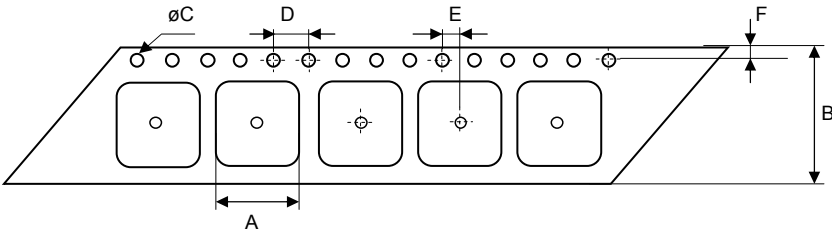

Gurtspezifikation / Tape specification:		
A	9,00 ± 0,1	mm
B	16,0 ± 0,2	mm
C	1,50 ^{+0,1} - 0,0	mm
D	4,00 ± 0,1	mm
E	2,00 ± 0,1	mm
F	1,75 ± 0,1	mm
G	9,00 ± 0,1	mm
H	3,50 ± 0,1	mm

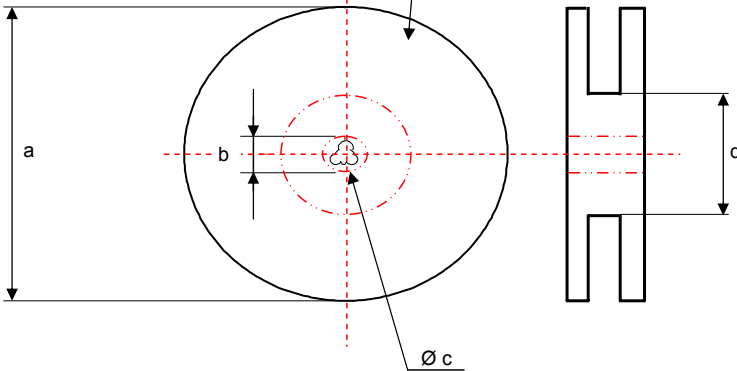
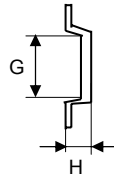

Rollenspezifikation / Reel specification:		
a	330,0 ± 2,0	mm
b	21,00 ± 0,8	mm
c	13,00 ± 0,5	mm
d	100,0 ± 1,0	mm

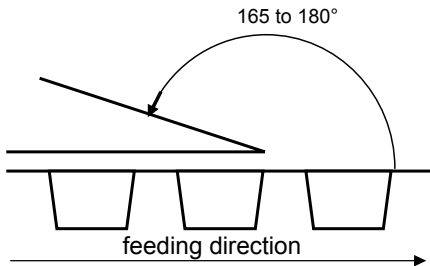

The force for tearing off cover tape is 10 to 130 grams in arrow direction

Freigabe erteilt / general release:	Kunde / customer		
		
Datum / date	Unterschrift / signature		
	Würth Elektronik		
		
Geprüft / checked	Kontrolliert / approved		
	Name	Änderung / modification	Datum / date
	MST	Version 5	04-10-11
	MST	Version 4	03-12-10
	RT	Version 3	03-02-24
	MST	Version 2	02-02-27
	JH	Version 1	00-12-06

This electronic component is designed and developed with the intention for use in general electronics equipments. Before incorporating the components into any equipments in the field such as aerospace, aviation, nuclear control, submarine, transportation, (automotive control, train control, ship control), transportation signal, disaster prevention, medical, public information network etc. where higher safety and reliability are especially required or if there is possibility of direct damage or injury to human body. In addition, even electronic component in general electronic equipments, when used in electrical circuits that require high safety, reliability functions or performance, the sufficient reliability evaluation-check for the safety must be performed before use. It is essential to give consideration when to install a protective circuit at the design stage.

Würth Elektronik eiSos GmbH & Co. KG

D-74638 Waldenburg · Max-Eyth-Strasse 1 - 3 · Germany · Telefon (+49) (0) 7942 - 945 - 0 · Telefax (+49) (0) 7942 - 945 - 400
<http://www.we-online.de>