

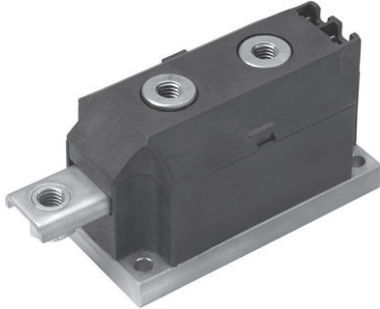

## SCR/SCR and SCR/Diode (MAGN-A-PAK Power Modules), 170 A/250 A



MAGN-A-PAK

### FEATURES

- High voltage
- Electrically isolated base plate
- 3500 V<sub>RMS</sub> isolating voltage
- Industrial standard package
- Simplified mechanical designs, rapid assembly
- High surge capability
- Large creepage distances
- UL approved file E78996 
- Compliant to RoHS directive 2002/95/EC
- Designed and qualified for industrial level



**RoHS**  
COMPLIANT

### PRODUCT SUMMARY

$I_{T(AV)}$	170 A/250 A
-------------	-------------

### DESCRIPTION

This new VSK series of MAGN-A-PAK modules uses high voltage power thyristor/thyristor and thyristor/diode in seven basic configurations. The semiconductors are electrically isolated from the metal base, allowing common heatsinks and compact assemblies to be built. They can be interconnected to form single phase or three phase bridges or as AC-switches when modules are connected in anti-parallel mode. These modules are intended for general purpose applications such as battery chargers, welders, motor drives, UPS, etc.

### MAJOR RATINGS AND CHARACTERISTICS

SYMBOL	CHARACTERISTICS	VSK.170..	VSK.250..	UNITS
$I_{T(AV)}$	85 °C	170	250	A
$I_{T(RMS)}$		377	555	
$I_{TSM}$	50 Hz	5100	8500	kA <sup>2</sup> s
	60 Hz	5350	8900	
$I^2t$	50 Hz	131	361	kA <sup>2</sup> √s
	60 Hz	119	330	
$I^2\sqrt{t}$		1310	3610	V
$V_{DRM}/V_{RRM}$		Up to 1600	Up to 2000	°C
$T_J$	Range	- 40 to 130		

# VSK.170PbF, VSK.250PbF Series



Vishay Semiconductors

SCR/SCR and SCR/Diode  
(MAGN-A-PAK Power Modules), 170 A/250 A

## ELECTRICAL SPECIFICATIONS

VOLTAGE RATINGS				
TYPE NUMBER	VOLTAGE CODE	$V_{RRM}/V_{DRM}$ , MAXIMUM REPETITIVE PEAK REVERSE AND OFF-STATE BLOCKING VOLTAGE V	$V_{RSM}$ , MAXIMUM NON-REPETITIVE PEAK REVERSE VOLTAGE V	$I_{RRM}/I_{DRM}$ AT 130 °C MAXIMUM mA
VSK.170-	04	400	500	50
	08	800	900	
	10	1000	1100	
	12	1200	1300	
	14	1400	1500	
	16	1600	1700	
VSK.250-	04	400	500	50
	08	800	900	
	10	1000	1100	
	12	1200	1300	
	14	1400	1500	
	16	1600	1700	
	18	1800	1900	
	20	2000	2100	60

ON-STATE CONDUCTION						
PARAMETER	SYMBOL	TEST CONDITIONS		VSK.170	VSK.250	UNITS
Maximum average on-state current at case temperature	$I_{T(AV)}$	180° conduction, half sine wave		170	250	A
				85	85	°C
Maximum RMS on-state current	$I_{T(RMS)}$	As AC switch		377	555	A
Maximum peak, one-cycle on-state non-repetitive, surge current	$I_{TSM}$	t = 10 ms	No voltage reappplied	5100	8500	
		t = 8.3 ms		5350	8900	
		t = 10 ms	100 % $V_{RRM}$ reappplied	4300	7150	
		t = 8.3 ms		4500	7500	
Maximum $I^2t$ for fusing	$I^2t$	t = 10 ms	No voltage reappplied	131	361	kA <sup>2</sup> s
		t = 8.3 ms		119	330	
		t = 10 ms	100 % $V_{RRM}$ reappplied	92.5	255	
		t = 8.3 ms		84.4	233	
Maximum $I^2\sqrt{t}$ for fusing	$I^2\sqrt{t}$	t = 0.1 ms to 10 ms, no voltage reappplied		1310	3610	kA <sup>2</sup> √s
Low level value or threshold voltage	$V_{T(TO)1}$	(16.7 % $\times \pi \times I_{T(AV)} < I < \pi \times I_{T(AV)}$ , $T_J = T_J$ maximum)		0.89	0.97	V
High level value of threshold voltage	$V_{T(TO)2}$	$(I > \pi \times I_{T(AV)} < I < \pi \times I_{T(AV)})$ , $T_J = T_J$ maximum		1.12	1.00	
Low level value on-state slope resistance	$r_{t1}$	(16.7 % $\times \pi \times I_{T(AV)} < I < \pi \times I_{T(AV)}$ , $T_J = T_J$ maximum)		1.34	0.60	mΩ
High level value on-state slope resistance	$r_{t2}$	$(I > \pi \times I_{T(AV)} < I < \pi \times I_{T(AV)})$ , $T_J = T_J$ maximum		0.96	0.57	
Maximum on-state voltage drop	$V_{TM}$	$I_{TM} = \pi \times I_{T(AV)}$ , $T_J = T_J$ maximum, 180° conduction, average power = $V_{T(TO)} \times I_{T(AV)} + r_f \times (I_{T(RMS)})^2$		1.60	1.44	V
Maximum holding current	$I_H$	Anode supply = 12 V, initial $I_T = 30$ A, $T_J = 25$ °C		500	500	mA
Maximum latching current	$I_L$	Anode supply = 12 V, resistive load = 1 Ω, gate pulse: 10 V, 100 μs, $T_J = 25$ °C		1000	1000	



# VSK.170PbF, VSK.250PbF Series

SCR/SCR and SCR/Diode  
(MAGN-A-PAK Power Modules), 170 A/250 A

Vishay Semiconductors

SWITCHING					
PARAMETER	SYMBOL	TEST CONDITIONS	VSK.170	VSK.250	UNITS
Typical delay time	$t_d$	$T_J = 25\text{ }^\circ\text{C}$ , gate current = 1 A $dI_g/dt = 1\text{ A}/\mu\text{s}$ $V_d = 0.67\% V_{DRM}$	1.0		$\mu\text{s}$
Typical rise time	$t_r$		2.0		
Typical turn-off time	$t_q$	$I_{TM} = 300\text{ A}$ ; $dI/dt = 15\text{ A}/\mu\text{s}$ ; $T_J = T_J\text{ maximum}$ ; $V_R = 50\text{ V}$ ; $dV/dt = 20\text{ V}/\mu\text{s}$ ; gate 0 V, 100 $\Omega$	50 to 150		

BLOCKING					
PARAMETER	SYMBOL	TEST CONDITIONS	VSK.170	VSK.250	UNITS
Maximum peak reverse and off-state leakage current	$I_{RRM}$ , $I_{DRM}$	$T_J = T_J\text{ maximum}$	50	60	mA
RMS insulation voltage	$V_{INS}$	50 Hz, circuit to base, all terminals shorted, 25 $^\circ\text{C}$ , 1 s	3000		V
Critical rate of rise of off-state voltage	$dV/dt$	$T_J = T_J\text{ maximum}$ , exponential to 67 % rated $V_{DRM}$	1000		V/ $\mu\text{s}$

TRIGGERING					
PARAMETER	SYMBOL	TEST CONDITIONS	VSK.170	VSK.250	UNITS
Maximum peak gate power	$P_{GM}$	$t_p \leq 5\text{ ms}$ , $T_J = T_J\text{ maximum}$	10.0		W
Maximum average gate power	$P_{G(AV)}$	$f = 50\text{ Hz}$ , $T_J = T_J\text{ maximum}$	2.0		
Maximum peak gate current	+ $I_{GM}$	$t_p \leq 5\text{ ms}$ , $T_J = T_J\text{ maximum}$	3.0		A
Maximum peak negative gate voltage	- $V_{GT}$	$t_p \leq 5\text{ ms}$ , $T_J = T_J\text{ maximum}$	5.0		V
Maximum required DC gate voltage to trigger	$V_{GT}$	$T_J = -40\text{ }^\circ\text{C}$	4.0		
		$T_J = 25\text{ }^\circ\text{C}$	3.0		
		$T_J = T_J\text{ maximum}$	2.0		
Maximum required DC gate current to trigger	$I_{GT}$	$T_J = -40\text{ }^\circ\text{C}$	350		mA
		$T_J = 25\text{ }^\circ\text{C}$	200		
		$T_J = T_J\text{ maximum}$	100		
Maximum gate voltage that will not trigger	$V_{GD}$	$T_J = T_J\text{ maximum}$ , rated $V_{DRM}$ applied	0.25		V
Maximum gate current that will not trigger	$I_{GD}$	$T_J = T_J\text{ maximum}$ , rated $V_{DRM}$ applied	10.0		mA
Maximum rate of rise of turned-on current	$dI/dt$	$T_J = T_J\text{ maximum}$ , $I_{TM} = 400\text{ A}$ , rated $V_{DRM}$ applied	500		A/ $\mu\text{s}$

THERMAL AND MECHANICAL SPECIFICATIONS					
PARAMETER	SYMBOL	TEST CONDITIONS	VSK.170	VSK.250	UNITS
Junction operating and storage temperature range	$T_J$ , $T_{Stg}$		- 40 to 130		$^\circ\text{C}$
Maximum thermal resistance, junction to case per junction	$R_{thJC}$	DC operation	0.17	0.125	K/W
Typical thermal resistance, case to heatsink per module	$R_{thCS}$	Mounting surface flat, smooth and greased	0.02	0.02	
Mounting torque $\pm 10\%$	MAP to heatsink busbar to MAP	A mounting compound is recommended and the torque should be rechecked after a period of about 3 hours to allow for the spread of the compound.	4 to 6		Nm
Approximate weight			500		g
			17.8		oz.
Case style			MAGN-A-PAK		

# VSK.170PbF, VSK.250PbF Series



Vishay Semiconductors

SCR/SCR and SCR/Diode  
(MAGN-A-PAK Power Modules), 170 A/250 A

<b>ΔR CONDUCTION PER JUNCTION</b>											
DEVICES	SINUSOIDAL CONDUCTION AT T <sub>J</sub> MAXIMUM					RECTANGULAR CONDUCTION AT T <sub>J</sub> MAXIMUM					UNITS
	180°	120°	90°	60°	30°	180°	120°	90°	60°	30°	
VSK.170-	0.009	0.010	0.010	0.020	0.032	0.007	0.011	0.015	0.020	0.033	K/W
VSK.250-	0.009	0.010	0.014	0.020	0.032	0.007	0.011	0.015	0.020	0.033	

**Note**

- Table shows the increment of thermal resistance R<sub>thJC</sub> when devices operate at different conduction angles than DC

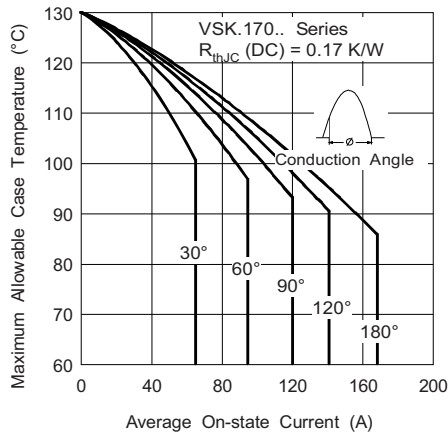

Fig. 1 - Current Ratings Characteristics

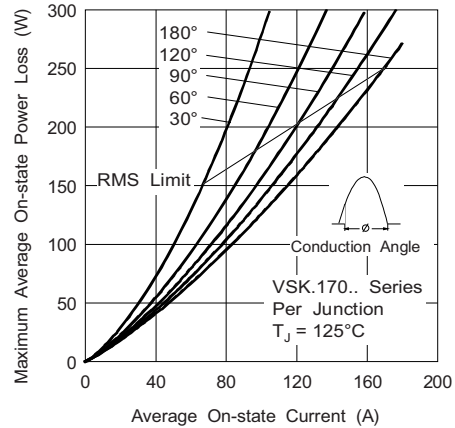

Fig. 3 - On-State Power Loss Characteristics

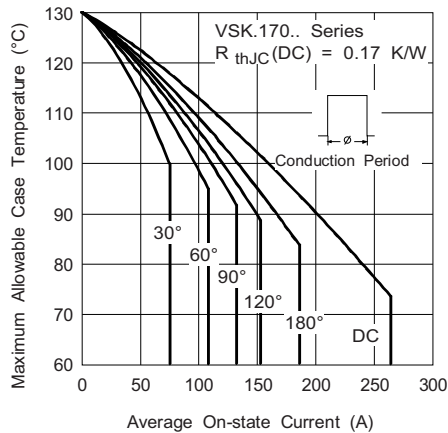

Fig. 2 - Current Ratings Characteristics

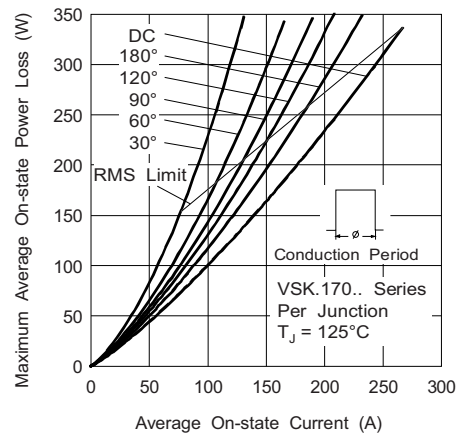

Fig. 4 - On-State Power Loss Characteristics



# VSK.170PbF, VSK.250PbF Series

SCR/SCR and SCR/Diode  
(MAGN-A-PAK Power Modules), 170 A/250 A  
Vishay Semiconductors

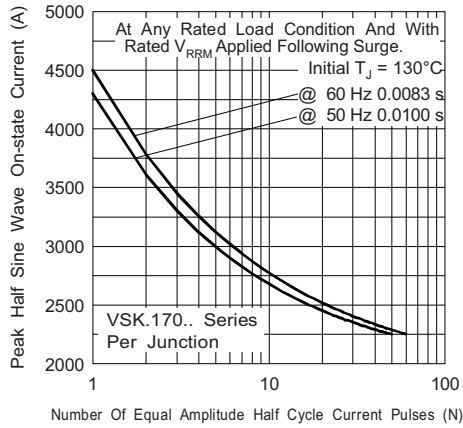

Fig. 5 - Maximum Non-Repetitive Surge Current

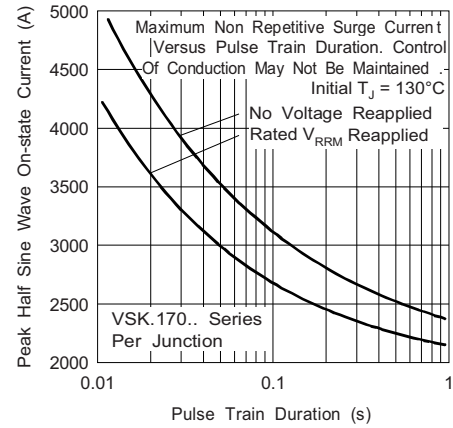

Fig. 6 - Maximum Non-Repetitive Surge Current

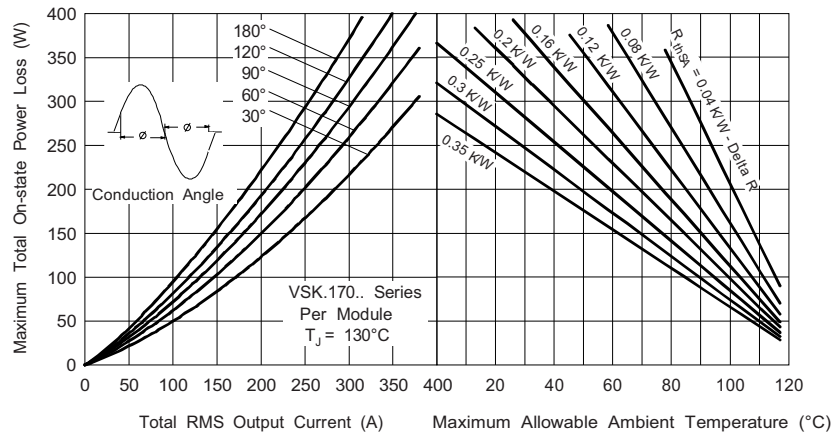

Fig. 7 - On-State Power Loss Characteristics

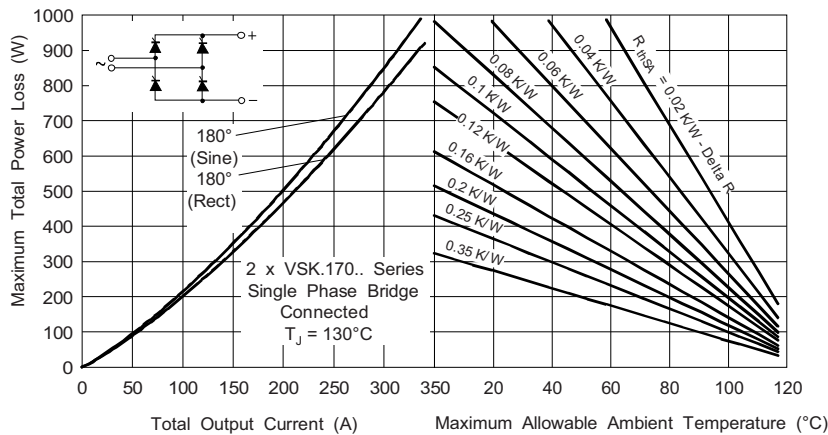

Fig. 8 - On-State Power Loss Characteristics

# VSK.170PbF, VSK.250PbF Series



Vishay Semiconductors

SCR/SCR and SCR/Diode  
(MAGN-A-PAK Power Modules), 170 A/250 A

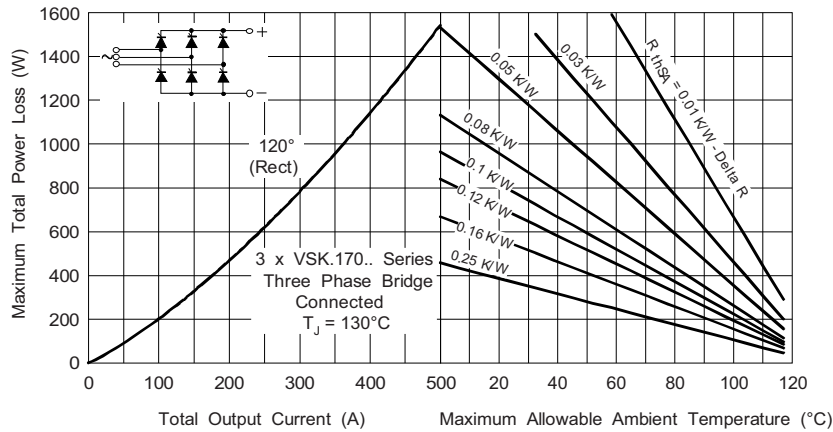

Fig. 9 - On-State Power Loss Characteristics

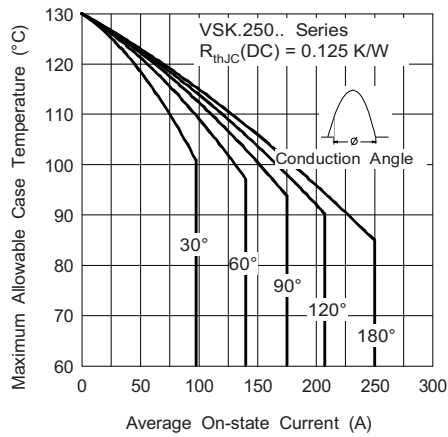

Fig. 10 - Current Ratings Characteristics

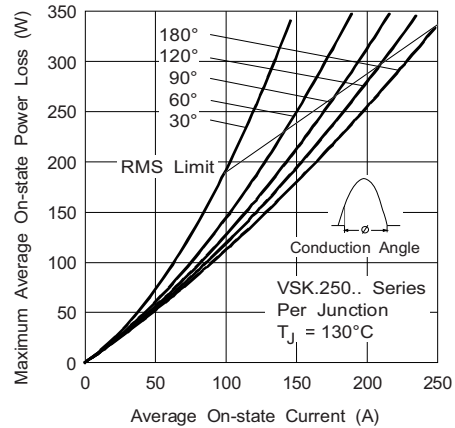

Fig. 12 - On-State Power Loss Characteristics

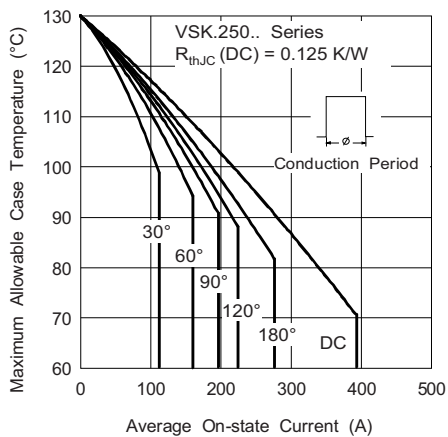

Fig. 11 - Current Ratings Characteristics

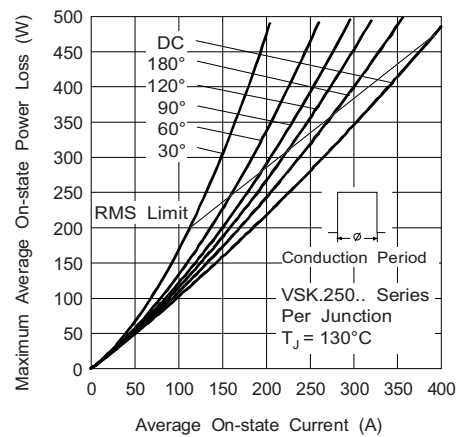

Fig. 13 - On-State Power Loss Characteristics



# VSK.170PbF, VSK.250PbF Series

SCR/SCR and SCR/Diode  
(MAGN-A-PAK Power Modules), 170 A/250 A

Vishay Semiconductors

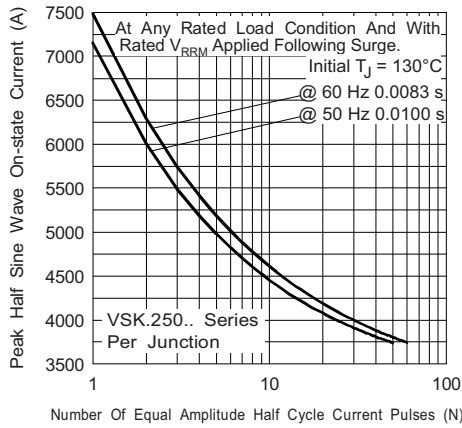

Fig. 14 - Maximum Non-Repetitive Surge Current

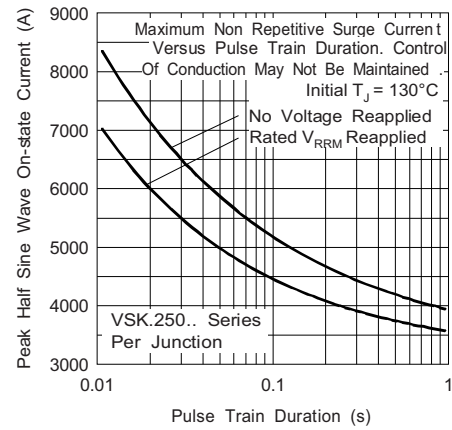

Fig. 15 - Maximum Non-Repetitive Surge Current

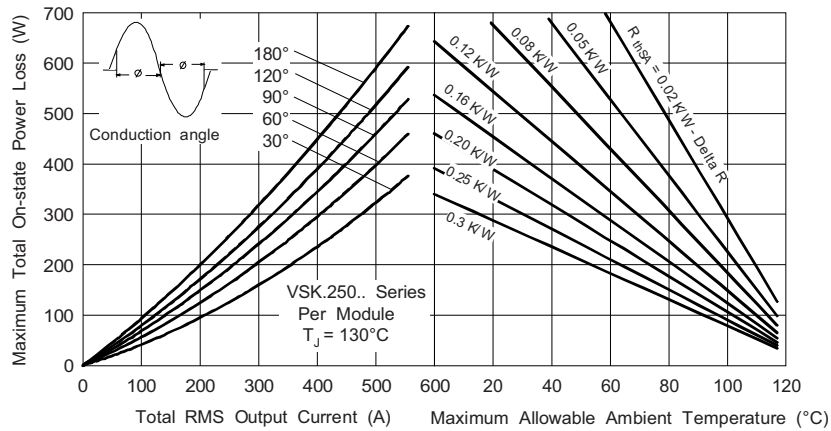

Fig. 16 - On-State Power Loss Characteristics

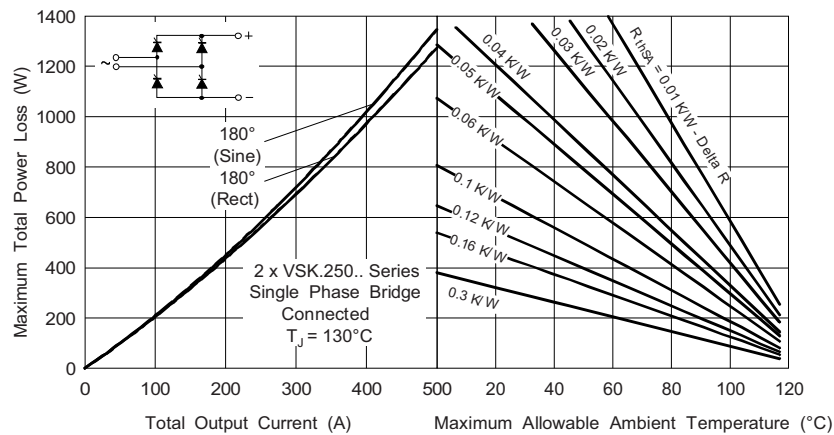

Fig. 17 - On-State Power Loss Characteristics

# VSK.170PbF, VSK.250PbF Series



Vishay Semiconductors

SCR/SCR and SCR/Diode  
(MAGN-A-PAK Power Modules), 170 A/250 A

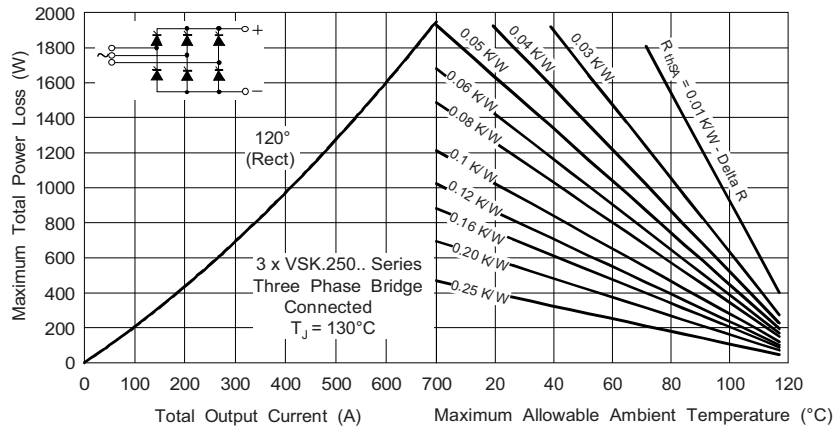

Fig. 18 - On-State Power Loss Characteristics

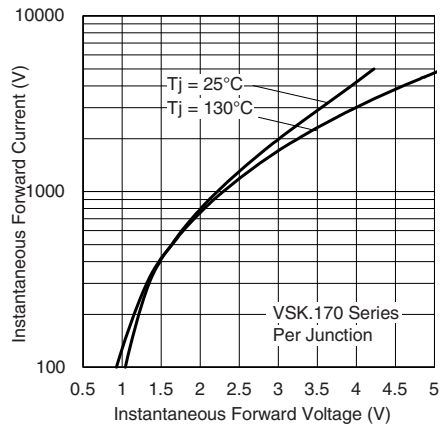

Fig. 19 - On-State Voltage Drop Characteristics

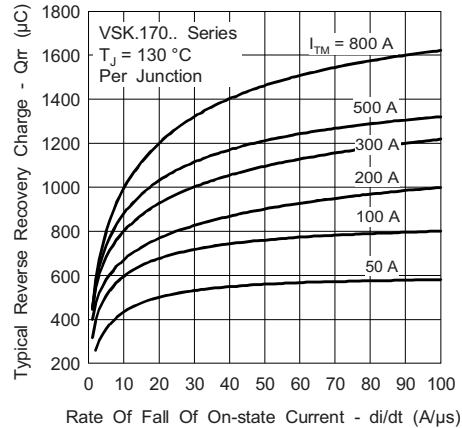

Fig. 21 - Reverse Recovery Charge Characteristics

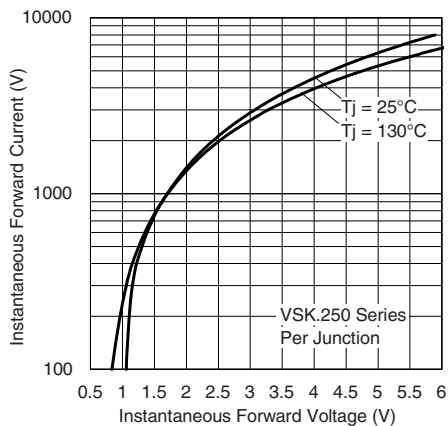

Fig. 20 - On-State Voltage Drop Characteristics

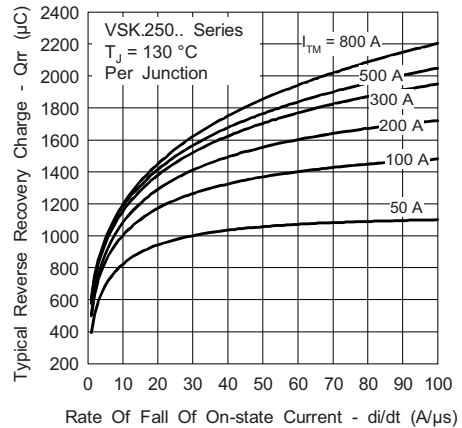

Fig. 22 - Reverse Recovery Charge Characteristics





# VSK.170PbF, VSK.250PbF Series

SCR/SCR and SCR/Diode  
(MAGN-A-PAK Power Modules), 170 A/250 A

Vishay Semiconductors

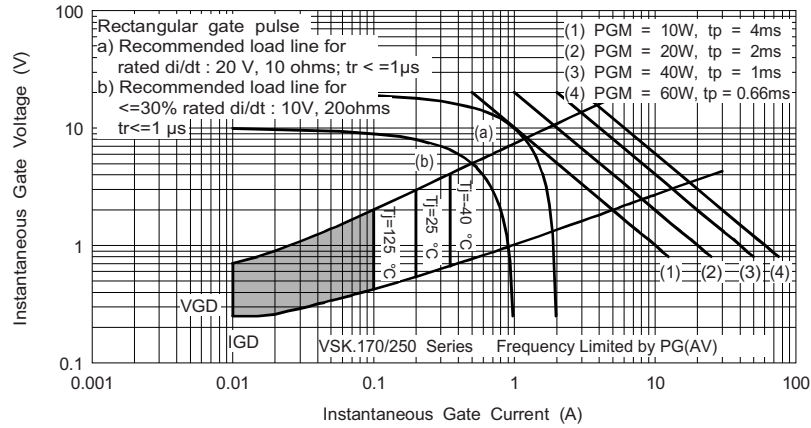

Fig. 23 - Gate Characteristics

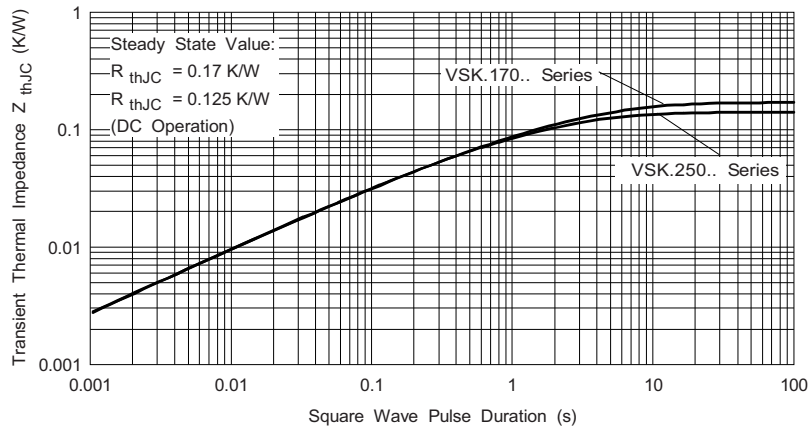

Fig. 24 - Thermal Impedance Z<sub>thJC</sub> Characteristics

## ORDERING INFORMATION TABLE

Device code	<b>VSK</b>	<b>T</b>	<b>250</b>	<b>-</b>	<b>20</b>	<b>PbF</b>
	①	②	③		④	⑤

- 1** - Module type
- 2** - Circuit configuration (see dimensions - link at the end of datasheet)
- 3** - Current rating
- 4** - Voltage code x 100 = V<sub>RRM</sub> (see Voltage Ratings table)
- 5** -
  - None = Standard production
  - PbF = Lead (Pb)-free

### Note

- To order the optional hardware go to [www.vishay.com/doc?95172](http://www.vishay.com/doc?95172)

# VSK.170PbF, VSK.250PbF Series



Vishay Semiconductors

SCR/SCR and SCR/Diode  
(MAGN-A-PAK Power Modules), 170 A/250 A

## CIRCUIT CONFIGURATION

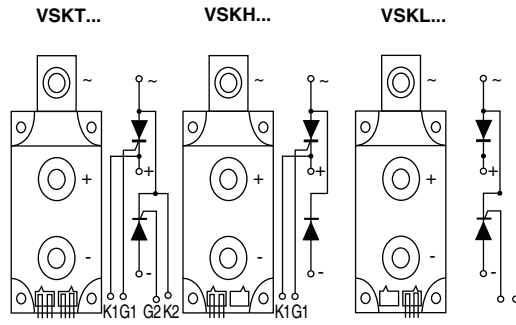

Available from 400 V to 1600 V for VSK.170PbF Series,  
available from 400 V to 2000 V for VSK.250PbF Series

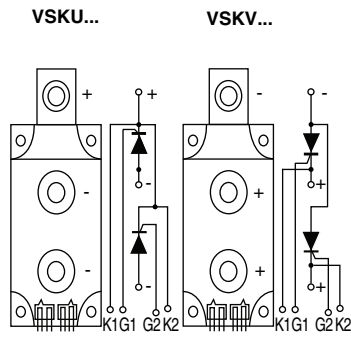

Available up to 1200 V,  
contact factory for different requirement

### LINKS TO RELATED DOCUMENTS

Dimensions

[www.vishay.com/doc?95086](http://www.vishay.com/doc?95086)

## MAGN-A-PAK

**DIMENSIONS** in millimeters (inches)

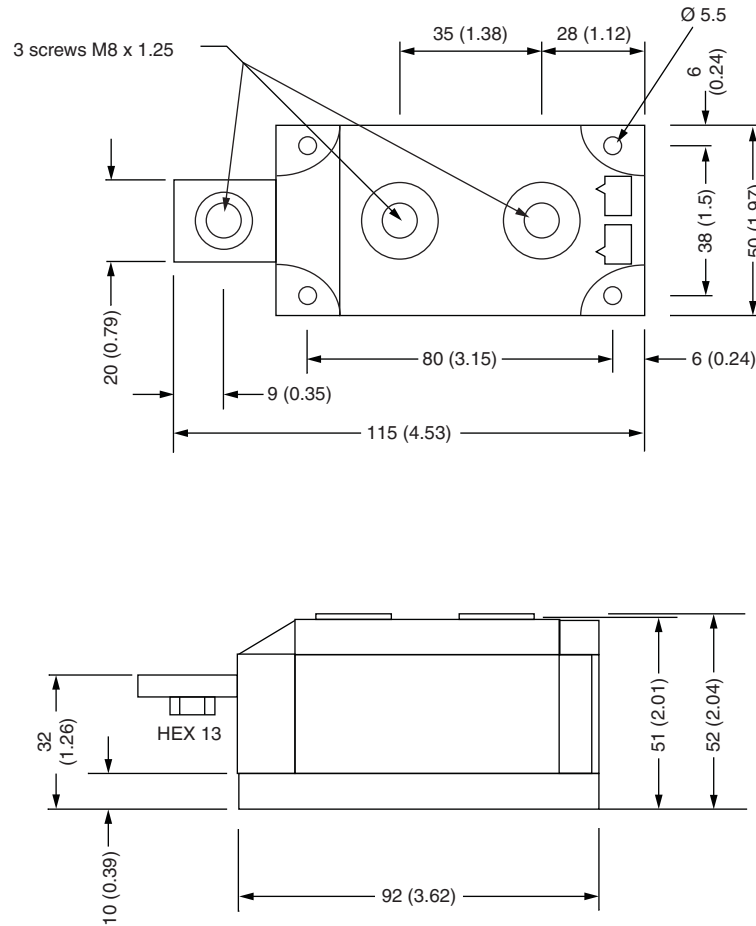

### Notes

- Dimensions are nominal
- Full engineering drawings are available on request
- UL identification number for gate and cathode wire: UL 1385
- UL identification number for package: UL 94 V-0



## **Disclaimer**

ALL PRODUCT, PRODUCT SPECIFICATIONS AND DATA ARE SUBJECT TO CHANGE WITHOUT NOTICE TO IMPROVE RELIABILITY, FUNCTION OR DESIGN OR OTHERWISE.

Vishay Intertechnology, Inc., its affiliates, agents, and employees, and all persons acting on its or their behalf (collectively, "Vishay"), disclaim any and all liability for any errors, inaccuracies or incompleteness contained in any datasheet or in any other disclosure relating to any product.

Vishay makes no warranty, representation or guarantee regarding the suitability of the products for any particular purpose or the continuing production of any product. To the maximum extent permitted by applicable law, Vishay disclaims (i) any and all liability arising out of the application or use of any product, (ii) any and all liability, including without limitation special, consequential or incidental damages, and (iii) any and all implied warranties, including warranties of fitness for particular purpose, non-infringement and merchantability.

Statements regarding the suitability of products for certain types of applications are based on Vishay's knowledge of typical requirements that are often placed on Vishay products in generic applications. Such statements are not binding statements about the suitability of products for a particular application. It is the customer's responsibility to validate that a particular product with the properties described in the product specification is suitable for use in a particular application. Parameters provided in datasheets and/or specifications may vary in different applications and performance may vary over time. All operating parameters, including typical parameters, must be validated for each customer application by the customer's technical experts. Product specifications do not expand or otherwise modify Vishay's terms and conditions of purchase, including but not limited to the warranty expressed therein.

Except as expressly indicated in writing, Vishay products are not designed for use in medical, life-saving, or life-sustaining applications or for any other application in which the failure of the Vishay product could result in personal injury or death. Customers using or selling Vishay products not expressly indicated for use in such applications do so at their own risk and agree to fully indemnify and hold Vishay and its distributors harmless from and against any and all claims, liabilities, expenses and damages arising or resulting in connection with such use or sale, including attorneys fees, even if such claim alleges that Vishay or its distributor was negligent regarding the design or manufacture of the part. Please contact authorized Vishay personnel to obtain written terms and conditions regarding products designed for such applications.

No license, express or implied, by estoppel or otherwise, to any intellectual property rights is granted by this document or by any conduct of Vishay. Product names and markings noted herein may be trademarks of their respective owners.

## **Material Category Policy**

**Vishay Intertechnology, Inc. hereby certifies that all its products that are identified as RoHS-Compliant fulfill the definitions and restrictions defined under Directive 2011/65/EU of The European Parliament and of the Council of June 8, 2011 on the restriction of the use of certain hazardous substances in electrical and electronic equipment (EEE) - recast, unless otherwise specified as non-compliant.**

**Please note that some Vishay documentation may still make reference to RoHS Directive 2002/95/EC. We confirm that all the products identified as being compliant to Directive 2002/95/EC conform to Directive 2011/65/EU.**