

COMPONENTS	IMPEDANCE
SMA MALE	50 OHM
N FEMALE BULKHEAD	50 OHM
PE-SR405FL	50 OHM

Standard Lengths	
-12	12"
-24	24"
-36	36"
-48	48"
-60	60"
-XXX	Custom Length in inches

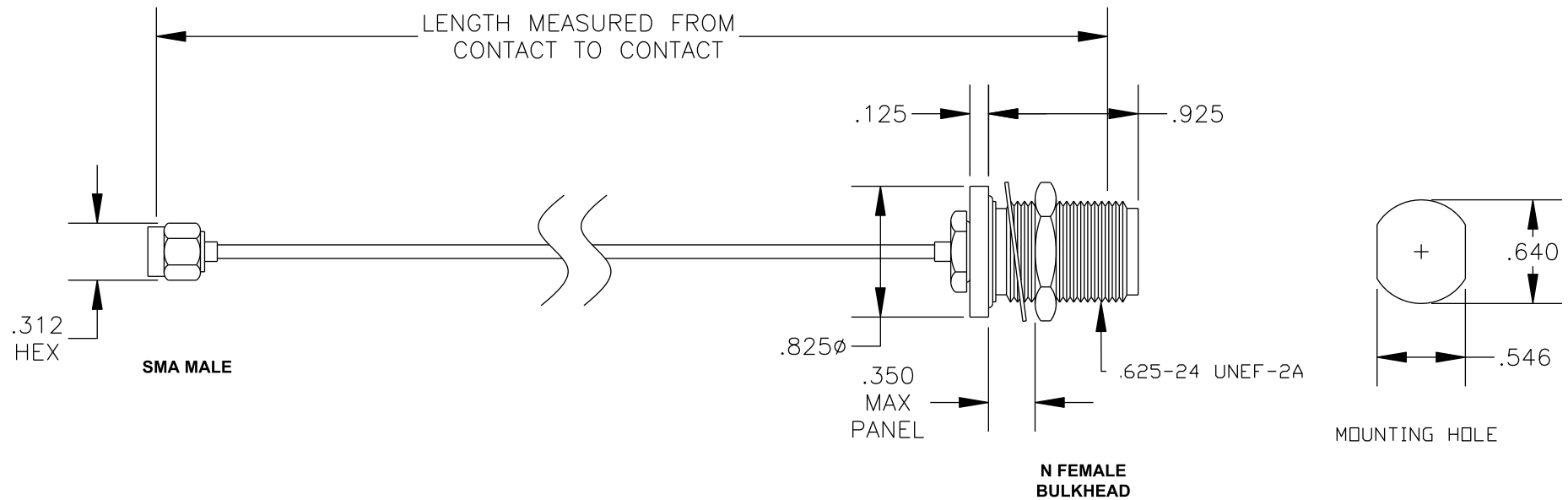

**PASTERNAK ENTERPRISES, INC.**

P.O BOX 16759, IRVINE, CA 92623  
PHONE (949) 261-1920 FAX (949) 261-7451

WEB ADDRESS: [www.pasternack.com](http://www.pasternack.com)  
E-MAIL ADDRESS: [sales@pasternack.com](mailto:sales@pasternack.com)

**COAXIAL & FIBER OPTICS**

DWG TITLE

**PE33844-XX**

DES. CABLE ASSEMBLY, PE-SR405FL, SMA MALE TO N FEMALE BULKHEAD

REV. A **FSCM NO. 53919**

CAD FILE 012408

SCALE N/A

SIZE A 147

NOTES:

1. UNLESS OTHERWISE SPECIFIED ALL DIMENSIONS ARE NOMINAL.
2. ALL SPECIFICATIONS ARE SUBJECT TO CHANGE WITHOUT NOTICE AT ANY TIME.
3. DIMENSIONS ARE IN INCHES.
4. LENGTH TOLERANCE IS  $\pm 1.5\%$  OR  $\pm 3/8"$ , WHICHEVER IS GREATER.