

August 1991

Features

- 50A, 50V and 60V
- $r_{DS(on)} = 0.8\Omega$
- SOA is Power-Dissipation Limited
- Nanosecond Switching Speeds
- Linear Transfer Characteristics
- High Input Impedance
- Majority Carrier Device

Description

The RFP4N05 and RFP4N06 are n-channel enhancement-mode silicon-gate power field-effect transistors designed for applications such as switching regulators, switching converters, motor drivers, relay drivers, and drivers for high-power bipolar switching transistors requiring high speed and low gate-drive power. These types can be operated directly from integrated circuits.

The RFP-series types are supplied in the JEDEC TO-220AB plastic package.

Package

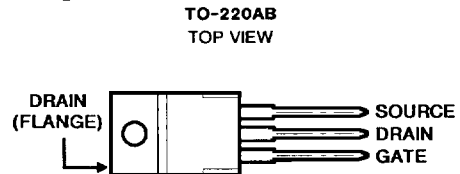

Terminal Diagram

N-CHANNEL ENHANCEMENT MODE

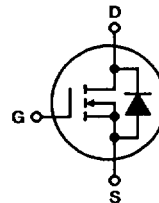

Absolute Maximum Ratings ($T_C = +25^\circ\text{C}$), Unless Otherwise Specified

	RFP4N05	RFP4N06	UNITS
Drain-Source Voltage	50	60	V
Drain-Gate Voltage ($R_{GS} = 1\text{M}\Omega$)	50	60	V
Continuous Drain Current	4	4	A
Pulsed Drain Current	10	10	A
Gate-Source Voltage	± 20	± 20	V
Maximum Power Dissipation			
$T_C = +25^\circ\text{C}$	25	25	W
Linear Derating Factor	0.2	0.2	W/ $^\circ\text{C}$
Operating and Storage Temperature	-55 to +150	-55 to +150	$^\circ\text{C}$

4
**N-CHANNEL
POWER MOSFETS**

Specifications RFP4N05, RFP4N06

Electrical Characteristics ($T_C = +25^\circ\text{C}$), Unless Otherwise Specified

CHARACTERISTIC	SYMBOLS	TEST CONDITIONS	LIMITS				UNITS
			RFP4N05		RFP4N06		
			MIN	MAX	MIN	MAX	
Drain-Source Breakdown Voltage	BV_{DSS}	$I_D = 1\text{ mA}, V_{GS} = 0$	50	-	60	-	V
Gate-Threshold Voltage	$V_{GS(th)}$	$V_{GS} = V_{DS}, I_D = 1\text{ mA}$	2	4	2	4	V
Zero-Gate Voltage Drain Current	I_{DSS}	$V_{DS} = 40\text{ V}$	-	1	-	-	μA
		$V_{DS} = 50\text{ V}$	-	-	-	1	μA
		$T_C = +125^\circ\text{C}$ $V_{DS} = 40\text{ V}$	-	50	-	-	μA
		$V_{DS} = 50\text{ V}$	-	-	-	50	μA
Gate-Source Leakage Current	I_{GSS}	$V_{GS} = \pm 20\text{ V}, V_{DS} = 0$	-	100	-	100	nA
Drain-Source On-Voltage	$V_{DS(on)}^*$	$I_D = 1\text{ A}, V_{GS} = 10\text{ V}$	-	0.8	-	0.8	V
		$I_D = 2\text{ A}, V_{GS} = 10\text{ V}$	-	2.0	-	2.0	V
		$I_D = 4\text{ A}, V_{GS} = 10\text{ V}$	-	4.8	-	4.8	V
Static Drain-Source On Resistance	$r_{DS(on)}^*$	$I_D = 1\text{ A}, V_{GS} = 10\text{ V}$	-	0.8	-	0.8	Ω
Forward Transconductance	g_{fs}^*	$I_D = 1\text{ A}, V_{DS} = 10\text{ V}$	400	-	400	-	S (S)
Input Capacitance	C_{ISS}	$V_{GS} = 0\text{ V}, V_{DS} = 25\text{ V}$ $f = 1\text{ MHz}$	-	200	-	200	pF
Output Capacitance	C_{OSS}		-	85	-	85	pF
Reverse-Transfer Capacitance	C_{RSS}		-	30	-	30	pF
Turn-On Delay Time	$t_{d(on)}$		$I_D = 1\text{ A}, V_{DD} = 30\text{ V}$ $R_{GEN} = R_{GS} = 50\Omega$ $V_{GS} = 10\text{ V}$	6 (typ)	15	6 (typ)	15
Rise Time	t_r	14 (typ)		30	14 (typ)	30	ns
Turn-Off Delay Time	$t_{d(off)}$	16 (typ)		30	16 (typ)	30	ns
Fall Time	t_f	14 (typ)		25	14 (typ)	25	ns
Thermal Resistance Junction-to-Case	$R_{\theta JC}$			-	5	-	5

* Pulsed: Pulse duration = 300 μs max., duty cycle = 2%.

Source-Drain Diode Ratings and Characteristics

CHARACTERISTIC	SYMBOLS	TEST CONDITIONS	LIMITS				UNITS
			RFP4N05		RFP4N06		
			MIN	MAX	MIN	MAX	
Diode Forward Voltage	V_{SD}^*	$I_{SD} = 1\text{ A}$	-	1.4	-	1.4	V
Diode Reverse Recovery Time	t_{rr}	$I_F = 2\text{ A}$ $dI_F/dt = 50\text{ A}/\mu\text{s}$	100 (typ)	100 (typ)	100 (typ)	100 (typ)	ns

* Pulsed: Pulse duration $\leq 300\mu\text{s}$ max., duty cycle $\leq 2\%$.

RFP4N05, RFP4N06

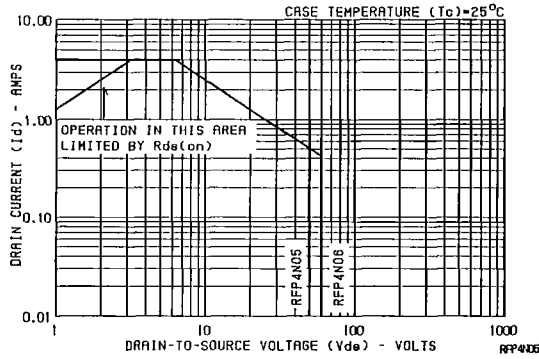

Fig. 1 — Maximum operating areas for all types.

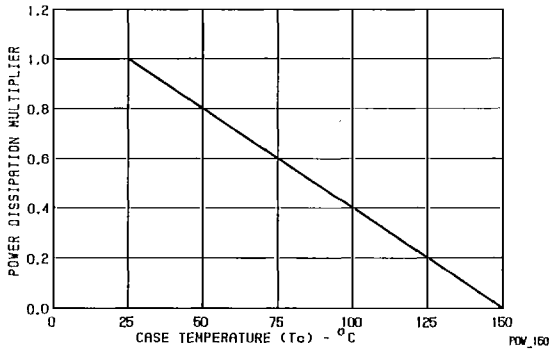

Fig. 2 — Power dissipation vs. case temperature derating curve for all types.

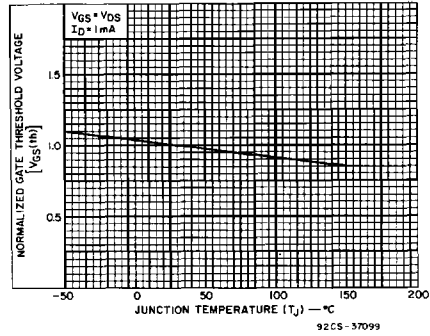

Fig. 3 — Typical normalized gate threshold voltage as a function of junction temperature for all types.

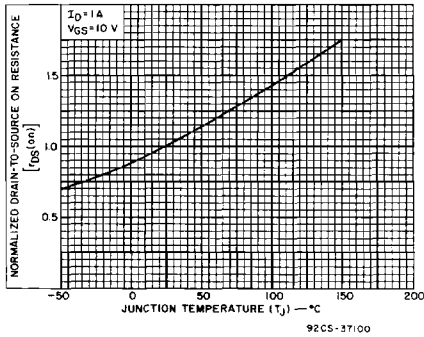

Fig. 4 — Normalized drain-to-source on resistance to junction temperature for all types.

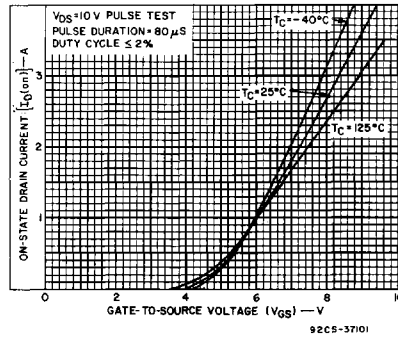

Fig. 5 — Typical transfer characteristics for all types.

4

**N-CHANNEL
POWER MOSFETS**

RFP4N05, RFP4N06

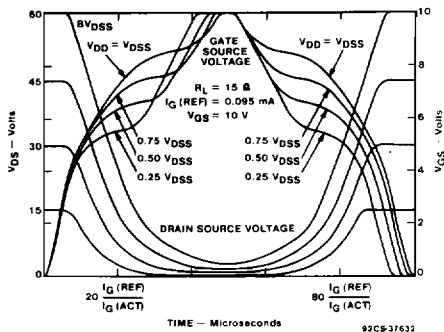

Fig. 6 - Normalized switching waveforms for constant gate-current. Refer to Harris application notes AN-7254 and AN-7260

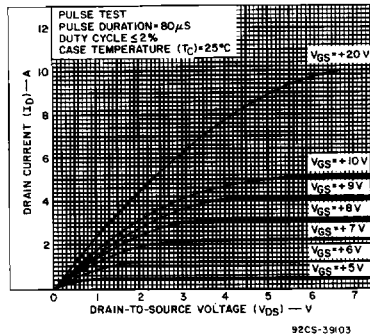

Fig. 7 - Typical saturation characteristics for all types.

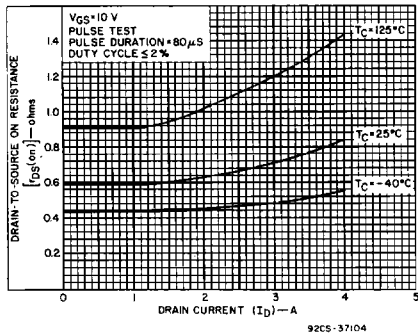

Fig. 8 - Typical drain-to-source on resistance as a function of drain current for all types.

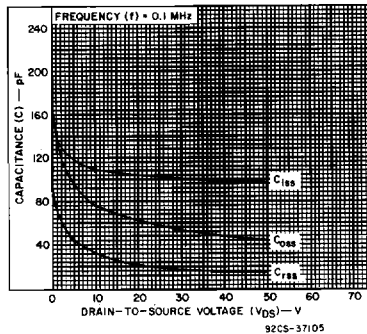

Fig. 9 - Capacitance as a function of drain-to-source voltage for all types

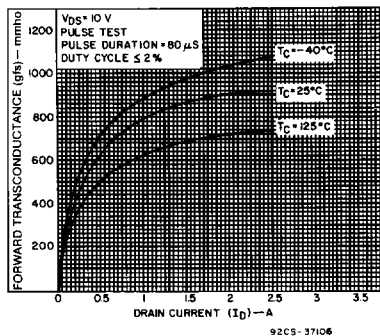

Fig. 10 - Typical forward transconductance as a function of drain current for all types.

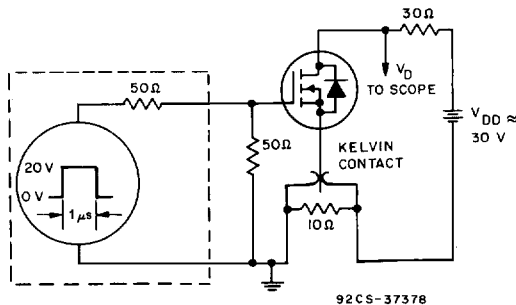

Fig. 11 - Switching Time Test Circuit