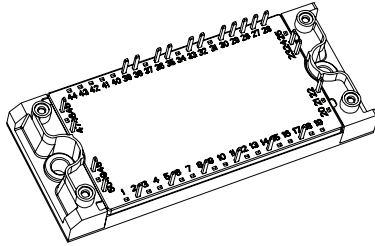

## IGBT PIM Module, 12 A

**ECONO2 PIM**
**FEATURES**

- Low  $V_{CE(on)}$  non punch through IGBT technology
- Low diode  $V_F$
- 10  $\mu$ s short circuit capability
- Square RBSOA
- HEXFRED® antiparallel diode with ultrasoft reverse recovery characteristics
- Positive  $V_{CE(on)}$  temperature coefficient
- Ceramic DBC substrate
- Low stray inductance design
- Speed 8 to 60 kHz
- Totally lead (Pb)-free
- Designed and qualified for industrial market

**RoHS**  
COMPLIANT

PRODUCT SUMMARY	
$V_{CES}$	600 V
$V_{CE(on)}$ (typical)	1.61 V
$t_{sc}$ at $T_J = 150\text{ }^\circ\text{C}$	> 10 $\mu$ s
$I_C$ at $T_C = 80\text{ }^\circ\text{C}$	12 A

**BENEFITS**

- Benchmark efficiency for motor control
- Rugged transient performance
- Low EMI, requires less snubbing
- Direct mounting to heatsink
- PCB solderable terminals
- Low junction to case thermal resistance
- UL approved E78996

ABSOLUTE MAXIMUM RATINGS						
	PARAMETER	SYMBOL	TEST CONDITIONS		MAX.	UNITS
Inverter	Collector to emitter voltage	$V_{CES}$			600	V
	Gate to emitter voltage	$V_{GES}$			$\pm 20$	
	Continuous collector current	$I_C$	$T_C = 25\text{ }^\circ\text{C}$		20	A
			$T_C = 80\text{ }^\circ\text{C}$		12	
	Pulsed collector current See fig. C.T.5	$I_{CM}$			40	A
	Diode maximum forward current	$I_{FM}$	Pulsed		40	A
Power dissipation	$P_D$	One IGBT	25 $^\circ\text{C}$	100	W	
Input rectifier	Repetitive peak reverse voltage	$V_{RRM}$			800	V
	Average output current	$I_{F(AV)}$	50/60 Hz sine pulse	80 $^\circ\text{C}$	10	A
	Surge current (non-repetitive)	$I_{FSM}$	Rated $V_{RRM}$ applied, 10 ms, sine pulse		310	
	$I^2t$ (non-repetitive)	$I^2t$			525	$\text{A}^2\text{s}$
Brake	Collector to emitter voltage	$V_{CES}$			600	V
	Gate to emitter voltage	$V_{GES}$			$\pm 20$	
	Continuous collector current	$I_C$	$T_C = 25\text{ }^\circ\text{C}$		10	A
			$T_C = 80\text{ }^\circ\text{C}$		6	
	Pulsed collector current See fig. C.T.5	$I_{CM}$			20	A
	Power dissipation	$P_D$	One IGBT	25 $^\circ\text{C}$	100	W
	Repetitive peak reverse voltage	$V_{RRM}$			600	V
	Maximum operating junction temperature	$T_J$			150	$^\circ\text{C}$
	Storage temperature range	$T_{Stg}$			- 40 to + 125	
	Isolation voltage	$V_{ISOL}$	AC (1 min)		2500	V

<b>ELECTRICAL SPECIFICATIONS</b> ( $T_J = 25\text{ }^\circ\text{C}$ unless otherwise noted)							
	PARAMETER	SYMBOL	TEST CONDITIONS	MIN.	TYP.	MAX.	UNITS
Inverter IGBT	Collector to emitter breakdown voltage	$BV_{(CES)}$	$V_{GE} = 0\text{ V}, I_C = 500\text{ }\mu\text{A}$	600	-	-	V
	Temperature coefficient of breakdown voltage	$\Delta V_{(BR)CES}/\Delta T_J$	$V_{GE} = 0\text{ V}, I_C = 1\text{ mA}$ ( $25\text{ }^\circ\text{C}$ to $125\text{ }^\circ\text{C}$ )	-	0.25	-	$V/^\circ\text{C}$
	Collector to emitter voltage	$V_{CE(on)}$	$I_C = 10\text{ A}, V_{GE} = 15\text{ V}$	-	1.61	1.86	V
			$I_C = 20\text{ A}, V_{GE} = 15\text{ V}$	-	2.10	2.49	
			$I_C = 10\text{ A}, V_{GE} = 15\text{ V}, T_J = 125\text{ }^\circ\text{C}$	-	1.79	1.97	
			$I_C = 20\text{ A}, V_{GE} = 15\text{ V}, T_J = 125\text{ }^\circ\text{C}$	-	2.45	2.72	
	Gate threshold voltage	$V_{GE(th)}$	$V_{CE} = V_{GE}, I_C = 250\text{ }\mu\text{A}$	4	-	6	
	Threshold voltage temperature coefficient	$\Delta V_{GE(th)}/\Delta T_J$	$V_{CE} = V_{GE}, I_C = 1\text{ mA}$ ( $25\text{ }^\circ\text{C}$ to $125\text{ }^\circ\text{C}$ )	-	-9.1	-	$\text{mV}/^\circ\text{C}$
	Zero gate voltage collector current	$I_{CES}$	$V_{GE} = 0\text{ V}, V_{CE} = 600\text{ V}$	-	-	100	$\mu\text{A}$
			$V_{GE} = 0\text{ V}, V_{CE} = 600\text{ V}$ $T_J = 125\text{ }^\circ\text{C}$	-	250	-	
	Gate to emitter leakage current	$I_{GES}$	$V_{GE} = \pm 20\text{ V}$	-	-	$\pm 200$	nA
	Total gate charge (turn-on)	$Q_G$	$I_C = 10\text{ A}$	-	51	76	nC
	Gate to emitter charge (turn-on)	$Q_{GE}$	$V_{CC} = 300\text{ V}$	-	12	18	
	Gate to collector charge (turn-on)	$Q_{GC}$	$V_{GE} = 15\text{ V}$	-	19	28	
	Turn-on switching loss	$E_{on}$	$I_C = 10\text{ A}, V_{CC} = 300\text{ V}$ $V_{GE} = 15\text{ V}, R_G = 22\text{ }\Omega$ $L = 500\text{ }\mu\text{H}, T_J = 25\text{ }^\circ\text{C}^{(1)}$	-	0.19	0.29	mJ
	Turn-off switching loss	$E_{off}$		-	0.11	0.17	
	Total switching loss	$E_{tot}$		-	0.30	0.45	
	Turn-on switching loss	$E_{on}$	$I_C = 10\text{ A}, V_{CC} = 300\text{ V}$ $V_{GE} = 15\text{ V}, R_G = 22\text{ }\Omega$ $L = 500\text{ }\mu\text{H}, T_J = 125\text{ }^\circ\text{C}^{(1)}$	-	0.24	0.36	mJ
	Turn-off switching loss	$E_{off}$		-	0.18	0.28	
	Total switching loss	$E_{tot}$		-	0.42	0.63	
Turn-on delay time	$t_{d(on)}$	$I_C = 10\text{ A}, V_{CC} = 300\text{ V}$ $V_{GE} = 15\text{ V}, R_G = 22\text{ }\Omega$ $L = 500\text{ }\mu\text{H}, T_J = 125\text{ }^\circ\text{C}$	-	87	131	ns	
Rise time	$t_r$		-	17	26		
Turn-off delay time	$t_{d(off)}$		-	116	174		
Fall time	$t_f$		-	161	242		
Input capacitance	$C_{ies}$	$V_{GE} = 0\text{ V}$	-	900	1350	pF	
Output capacitance	$C_{oes}$	$V_{CC} = 30\text{ V}$	-	263	395		
Reverse transfer capacitance	$C_{res}$	$f = 1\text{ MHz}$	-	30	45		
Inverter IGBT	Reverse bias safe operating area	RBSOA	$T_J = 125\text{ }^\circ\text{C}, I_C = 40\text{ A}$ $R_G = 22\text{ }\Omega, V_{GE} = 15\text{ V to }0$	Fullsquare			
	Short circuit safe operating area	SCSOA	$T_J = 150\text{ }^\circ\text{C}$ $V_{CC} = 300\text{ V}, V_P = 600\text{ V}$ $R_G = 22\text{ }\Omega, V_{GE} = 15\text{ V to }0\text{ V}$	10	-	-	$\mu\text{s}$
Inverter Diode	Diode peak reverse recovery current	$I_{rr}$	$T_J = 125\text{ }^\circ\text{C}$ $V_{CC} = 300\text{ V}, I_F = 10\text{ A}, L = 500\text{ }\mu\text{H}$ $R_G = 22\text{ }\Omega, V_{GE} = 15\text{ V}$	-	23	-	A
	Diode forward voltage drop	$V_{FM}$	$I_F = 10\text{ A}$	-	1.23	1.49	V
			$I_F = 20\text{ A}$	-	1.43	1.84	
			$I_F = 10\text{ A}, T_J = 125\text{ }^\circ\text{C}$	-	1.18	1.44	
$I_F = 20\text{ A}, T_J = 125\text{ }^\circ\text{C}$			-	1.44	1.79		

<b>ELECTRICAL SPECIFICATIONS</b> ( $T_J = 25\text{ }^\circ\text{C}$ unless otherwise noted)							
	PARAMETER	SYMBOL	TEST CONDITIONS	MIN.	TYP.	MAX.	UNITS
Input Rectifier	Maximum forward voltage drop	$V_{FM}$	$I_F = 10\text{ A}$	-	-	1.04	V
	Maximum reverse leakage current	$I_{RM}$	$T_J = 25\text{ }^\circ\text{C}, V_R = 800\text{ V}$	-	-	0.2	mA
			$T_J = 150\text{ }^\circ\text{C}, V_R = 800\text{ V}$	-	-	1	
	Forward slope resistance	$r_T$	$T_J = 150\text{ }^\circ\text{C}$	-	12.7	-	m $\Omega$
Conduction threshold voltage	$V_{F(TO)}$	-		0.70	-	V	
Brake IGBT	Collector to emitter breakdown voltage	$BV_{(CES)}$	$V_{GE} = 0\text{ V}, I_C = 500\text{ }\mu\text{A}$	600	-	-	
	Temperature coefficient of breakdown voltage	$\Delta V_{(BR)CES}/\Delta T_J$	$V_{GE} = 0\text{ V}, I_C = 1\text{ mA}$ ( $25\text{ }^\circ\text{C}$ to $125\text{ }^\circ\text{C}$ )	-	0.25	-	V/ $^\circ\text{C}$
	Collector to emitter voltage	$V_{CE(on)}$	$I_C = 5\text{ A}, V_{GE} = 15\text{ V}$	-	1.29	1.43	V
			$I_C = 10\text{ A}, V_{GE} = 15\text{ V}$	-	1.61	1.80	
			$I_C = 5\text{ A}, V_{GE} = 15\text{ V}, T_J = 125\text{ }^\circ\text{C}$	-	1.37	1.49	
			$I_C = 10\text{ A}, V_{GE} = 15\text{ V}, T_J = 125\text{ }^\circ\text{C}$	-	1.80	2.0	
	Gate threshold voltage	$V_{GE(th)}$	$V_{CE} = V_{GE}, I_C = 250\text{ }\mu\text{A}$	4	-	6	
	Threshold voltage temperature coefficient	$\Delta V_{GE(th)}/\Delta T_J$	$V_{CE} = V_{GE}, I_C = 1\text{ mA}$ ( $25\text{ }^\circ\text{C}$ to $125\text{ }^\circ\text{C}$ )	-	-9.1	-	mV/ $^\circ\text{C}$
	Zero gate voltage collector current	$I_{CES}$	$V_{GE} = 0\text{ V}, V_{CE} = 600\text{ V}$	-	-	100	$\mu\text{A}$
			$V_{GE} = 0\text{ V}, V_{CE} = 600\text{ V}$ $T_J = 125\text{ }^\circ\text{C}$	-	150	-	
	Gate to emitter leakage current	$I_{GES}$	$V_{GE} = \pm 20\text{ V}$	-	-	$\pm 200$	nA
	Total gate charge (turn-on)	$Q_G$	$I_C = 5\text{ A}$ $V_{CC} = 300\text{ V}$ $V_{GE} = 15\text{ V}$	-	53	79	nC
	Gate to emitter charge (turn-on)	$Q_{GE}$		-	11	17	
	Gate to collector charge (turn-on)	$Q_{GC}$		-	18	27	
	Turn-on switching loss	$E_{on}$	$I_C = 5\text{ A}, V_{CC} = 300\text{ V}$ $V_{GE} = 15\text{ V}, R_G = 22\text{ }\Omega$ $L = 500\text{ }\mu\text{H}, T_J = 25\text{ }^\circ\text{C}^{(1)}$	-	0.11	0.16	mJ
	Turn-off switching loss	$E_{off}$		-	0.10	0.14	
	Total switching loss	$E_{tot}$		-	0.20	0.30	
	Turn-on switching loss	$E_{on}$	$I_C = 5\text{ A}, V_{CC} = 300\text{ V}$ $V_{GE} = 15\text{ V}, R_G = 22\text{ }\Omega$ $L = 500\text{ }\mu\text{H}, T_J = 125\text{ }^\circ\text{C}^{(1)}$	-	0.13	0.20	mJ
	Turn-off switching loss	$E_{off}$		-	0.17	0.25	
Total switching loss	$E_{tot}$	-		0.30	0.45		
Turn-on delay time	$t_{d(on)}$	$I_C = 5\text{ A}, V_{CC} = 300\text{ V}$ $V_{GE} = 15\text{ V}, R_G = 22\text{ }\Omega$ $L = 500\text{ }\mu\text{H}, T_J = 125\text{ }^\circ\text{C}$	-	86	129	ns	
Rise time	$t_r$		-	12	18		
Turn-off delay time	$t_{d(off)}$		-	117	176		
Fall time	$t_f$		-	184	276		
Brake IGBT	Input capacitance	$C_{ies}$	$V_{GE} = 0\text{ V}$ $V_{CC} = 30\text{ V}$ $f = 1\text{ MHz}$	-	900	1350	pF
	Output capacitance	$C_{oes}$		-	263	395	
	Reverse transfer capacitance	$C_{res}$		-	30	45	
	Reverse bias safe operating area	RBSOA	$T_J = 150\text{ }^\circ\text{C}, I_C = 20\text{ A}$ $R_G = 22\text{ }\Omega, V_{GE} = 15\text{ V to }0$	Fullsquare			
	Short circuit safe operating area	SCSOA	$T_J = 150\text{ }^\circ\text{C}$ $V_{CC} = 300\text{ V}, V_P = 600\text{ V}$ $R_G = 22\text{ }\Omega, V_{GE} = 15\text{ V to }0$	10	-	-	$\mu\text{s}$

<b>ELECTRICAL SPECIFICATIONS</b> ( $T_J = 25\text{ }^\circ\text{C}$ unless otherwise noted)							
	PARAMETER	SYMBOL	TEST CONDITIONS	MIN.	TYP.	MAX.	UNITS
Brake Diode	Diode peak reverse recovery current	$I_{rr}$	$V_{CC} = 300\text{ V}$ , $I_F = 5\text{ A}$ , $L = 500\text{ }\mu\text{H}$ $V_{GE} = 15\text{ V}$ to 0, $R_G = 22\text{ }\Omega$	-	18	-	A
	Diode forward voltage drop	$V_{FM}$	$I_F = 5\text{ A}$	-	1.22	1.46	V
			$I_F = 10\text{ A}$	-	1.41	1.70	
			$I_F = 5\text{ A}$ , $T_J = 125\text{ }^\circ\text{C}$	-	1.16	1.43	
			$I_F = 10\text{ A}$ , $T_J = 125\text{ }^\circ\text{C}$	-	1.41	1.74	
NTC	Resistance	R	$T_J = 25\text{ }^\circ\text{C}$	-	5000	-	$\Omega$
			$T_J = 100\text{ }^\circ\text{C}$	-	4933	-	
	B value	B	$T_J = 25\text{ }^\circ\text{C}/50\text{ }^\circ\text{C}$	-	3375	-	K

**Note**

(1) Energy losses include “tail” and diode reverse recovery

<b>THERMAL AND MECHANICAL SPECIFICATIONS</b>					
PARAMETER	SYMBOL	MIN.	TYP.	MAX.	UNITS
Junction to case inverter IGBT thermal resistance	$R_{thJC}$	-	-	1.25	$^\circ\text{C}/\text{W}$
Junction to case inverter FRED thermal resistance		-	-	2.44	
Junction to case brake DIODE thermal resistance		-	-	3.08	
Junction to case brake IGBT thermal resistance		-	-	1.25	
Junction to case input rectifier thermal resistance		-	-	1.03	
Case to sink, flat, greased surface	$R_{thCS}$	-	0.05	-	
Mounting torque (M5)		2.7	-	3.3	Nm
Weight		-	170	-	g

**INVERTER**

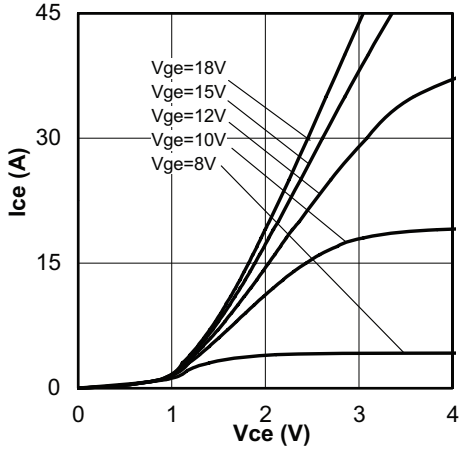

Fig. 1 - Typical IGBT Output Characteristics  
 $T_J = 25^\circ\text{C}$ ;  $t_p = 80 \mu\text{s}$

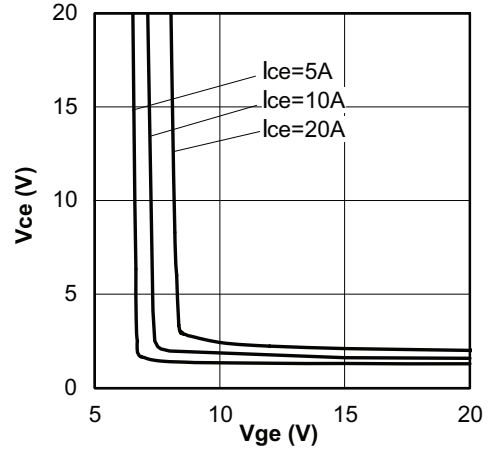

Fig. 4 - Typical  $V_{CE}$  vs.  $V_{GE}$   
 $T_J = 25^\circ\text{C}$

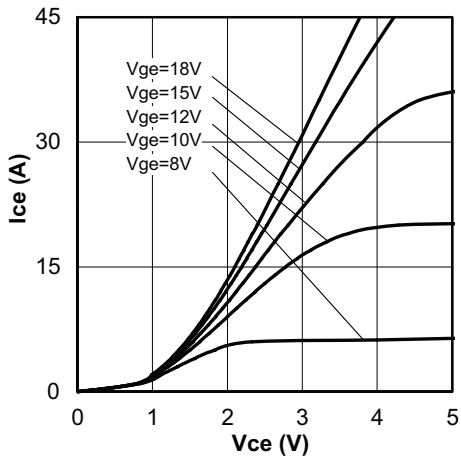

Fig. 2 - Typical IGBT Output Characteristics  
 $T_J = 125^\circ\text{C}$ ;  $t_p = 80 \mu\text{s}$

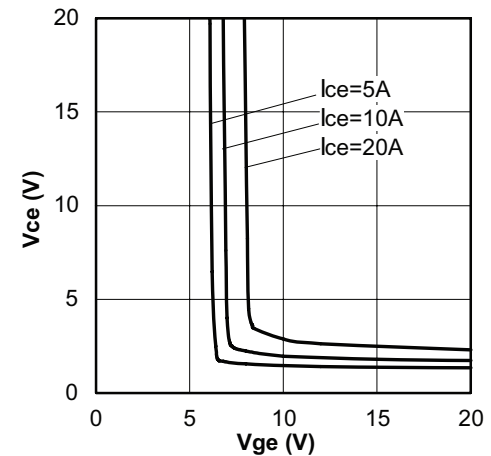

Fig. 5 - Typical  $V_{CE}$  vs.  $V_{GE}$   
 $T_J = 125^\circ\text{C}$

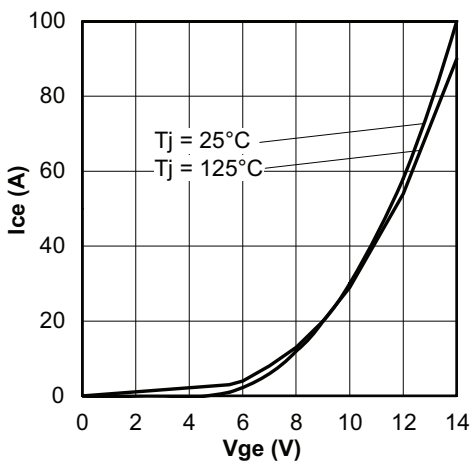

Fig. 3 - Typical Transfer Characteristics  
 $V_{CE} = 50 \text{ V}$ ;  $t_p = 10 \mu\text{s}$

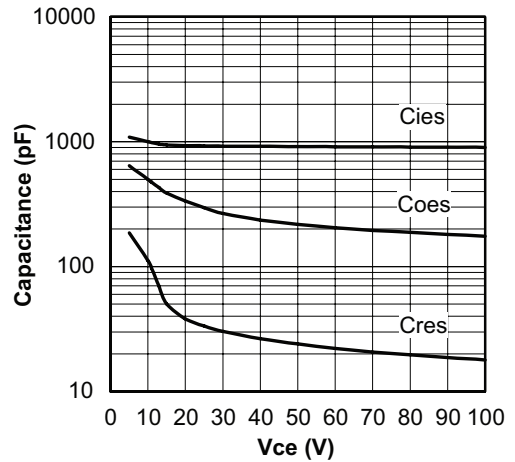

Fig. 6 - Typical Capacitance vs.  $V_{CE}$   
 $V_{GE} = 0 \text{ V}$ ;  $f = 1 \text{ MHz}$

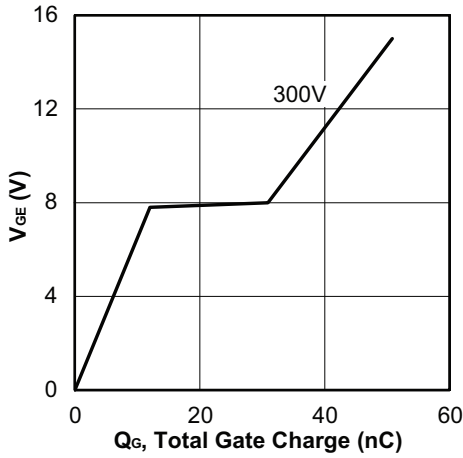

Fig. 7 - Typical Gate Charge vs.  $V_{GE}$   
 $I_{CE} = 10\text{ A}$

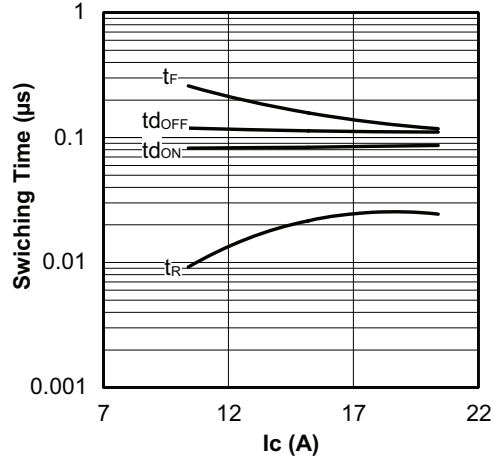

Fig. 10 - Typical Switching Time vs.  $I_C$   
 $T_J = 125\text{ }^\circ\text{C}$ ;  $L = 500\text{ }\mu\text{H}$ ;  $V_{CE} = 300\text{ V}$ ;  $R_G = 22\text{ }\Omega$ ;  $V_{GE} = 15\text{ V}$

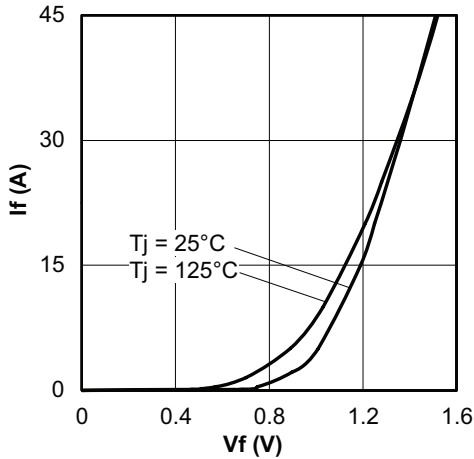

Fig. 8 - Typical Diode Forward Characteristics  
 $t_p = 80\text{ }\mu\text{s}$

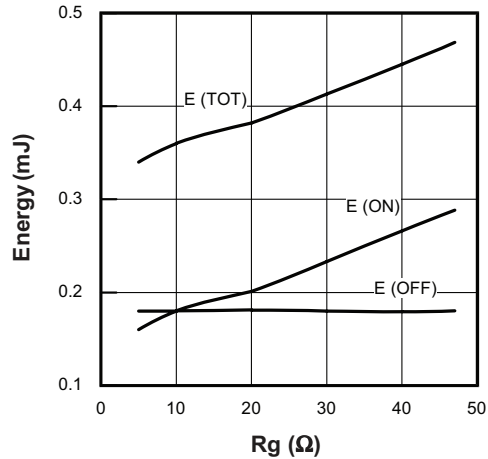

Fig. 11 - Typical Energy Loss vs.  $R_G$   
 $T_J = 125\text{ }^\circ\text{C}$ ;  $L = 500\text{ }\mu\text{H}$ ;  $V_{CE} = 300\text{ V}$ ;  $I_{CE} = 10\text{ A}$ ;  $V_{GE} = 15\text{ V}$

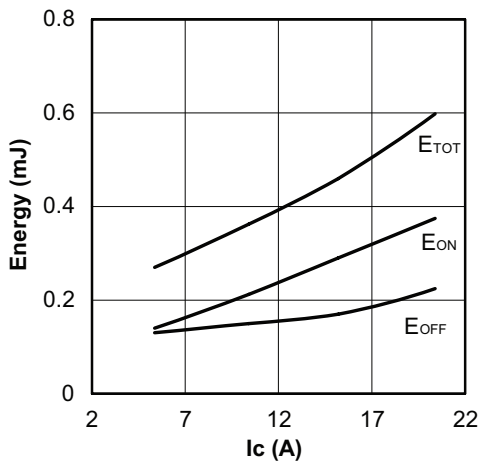

Fig. 9 - Typical Energy Loss vs.  $I_C$   
 $T_J = 125\text{ }^\circ\text{C}$ ;  $L = 500\text{ }\mu\text{H}$ ;  $V_{CE} = 300\text{ V}$ ;  $R_G = 22\text{ }\Omega$ ;  $V_{GE} = 15\text{ V}$

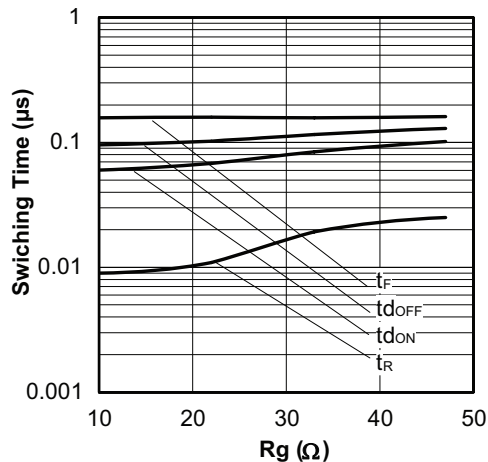

Fig. 12 - Typical Switching Time vs.  $R_G$   
 $T_J = 125\text{ }^\circ\text{C}$ ;  $L = 500\text{ }\mu\text{H}$ ;  $V_{CE} = 300\text{ V}$ ;  $I_{CE} = 10\text{ A}$ ;  $V_{GE} = 15\text{ V}$

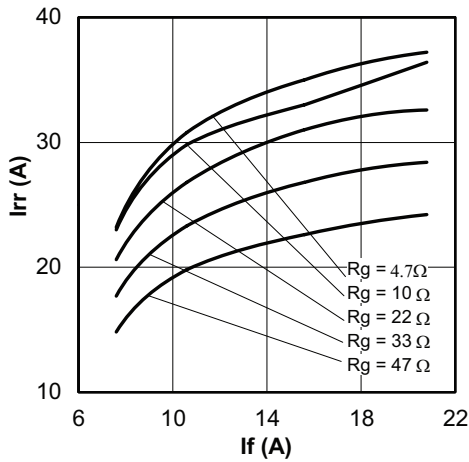
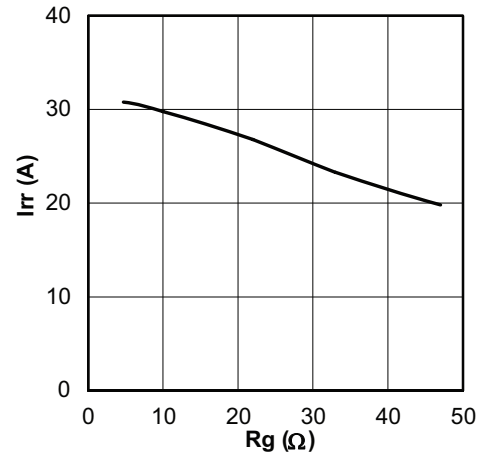
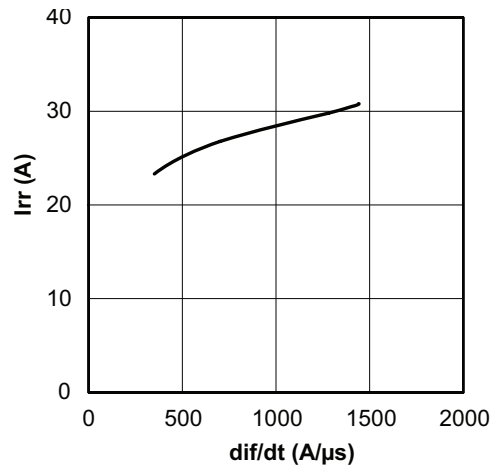
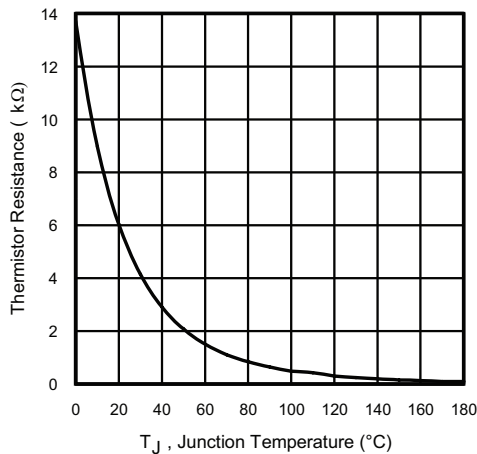
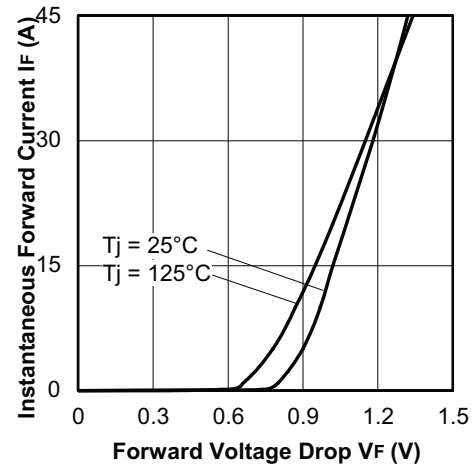

 Fig. 13 - Typical Diode  $I_{RR}$  vs.  $I_F$   
 $T_J = 125^\circ\text{C}$ 

 Fig. 14 - Typical Diode  $I_{RR}$  vs.  $R_G$   
 $T_J = 125^\circ\text{C}$ ;  $I_F = 10\text{ A}$ 

 Fig. 15 - Typical Diode  $I_{RR}$  vs.  $df/dt$   
 $V_{CC} = 300\text{ V}$ ;  $V_{GE} = 15\text{ V}$ ;  $I_F = 10\text{ A}$ ;  $T_J = 125^\circ\text{C}$ 
**THERMISTOR**

Fig. 16 - Thermistor Resistance vs. Temperature

**INPUT RECTIFIER**

 Fig. 17 - Typical Diode Forward Characteristics  
 $t_p = 80\ \mu\text{s}$

## INVERTER

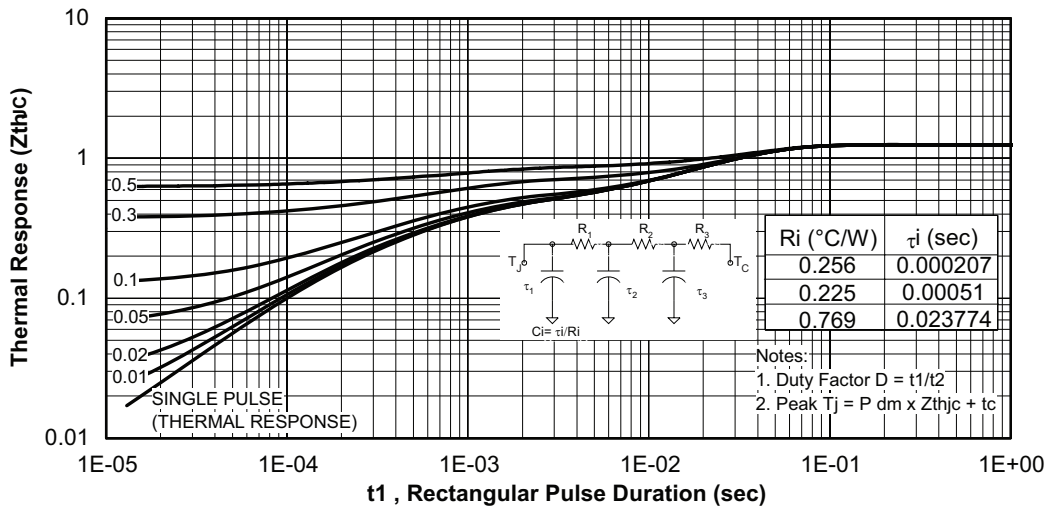

Fig. 18 - Maximum Transient Thermal Impedance, Junction to Case (Inverter IGBT)

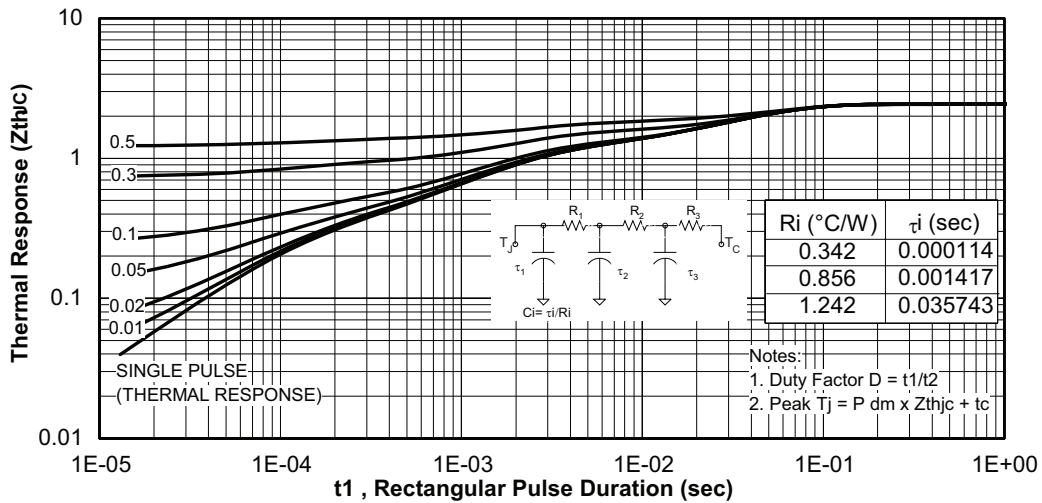

Fig. 19 - Maximum Transient Thermal Impedance, Junction to Case (Inverter FRED)



**BRAKE**

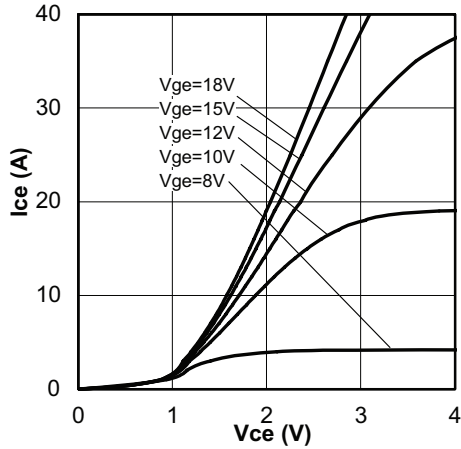

Fig. 20 - Typical IGBT Output Characteristics  
 $T_J = 25^\circ\text{C}$ ;  $t_p = 80 \mu\text{s}$

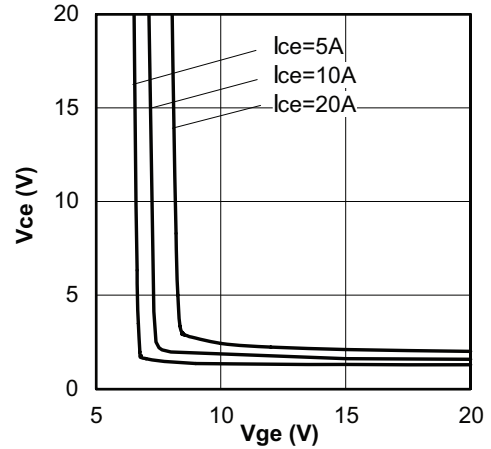

Fig. 23 - Typical  $V_{CE}$  vs.  $V_{GE}$   
 $T_J = 25^\circ\text{C}$

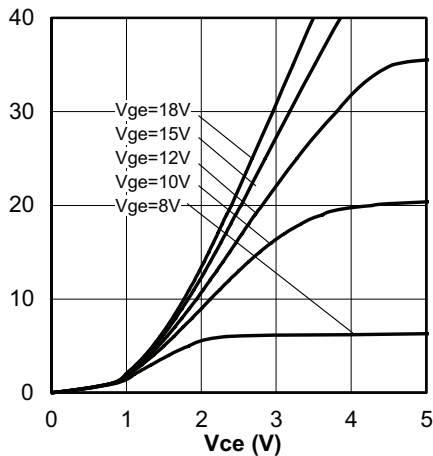

Fig. 21 - Typical IGBT Output Characteristics  
 $T_J = 125^\circ\text{C}$ ;  $t_p = 80 \mu\text{s}$

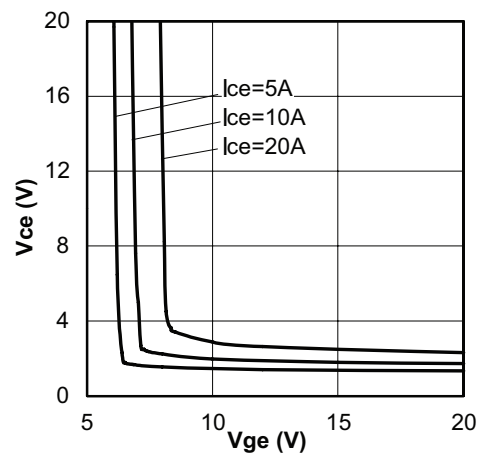

Fig. 24 - Typical  $V_{CE}$  vs.  $V_{GE}$   
 $T_J = 125^\circ\text{C}$

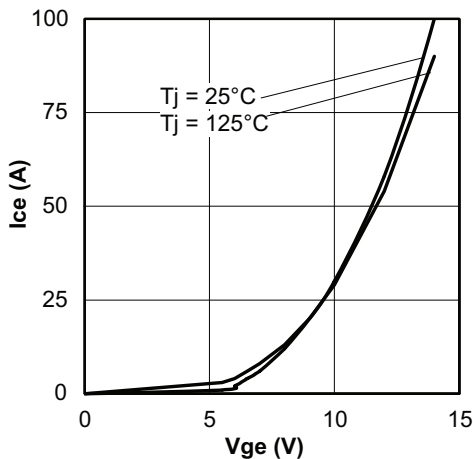

Fig. 22 - Typical Transfer Characteristics  
 $V_{CE} = 50 \text{ V}$ ;  $t_p = 10 \mu\text{s}$

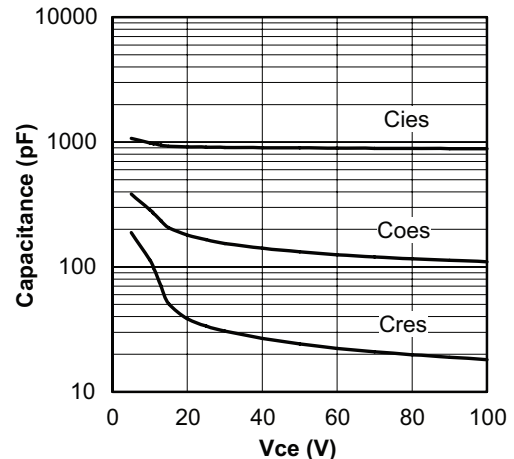

Fig. 25 - Typical Capacitance vs.  $V_{CE}$   
 $V_{GE} = 0 \text{ V}$ ;  $f = 1 \text{ MHz}$

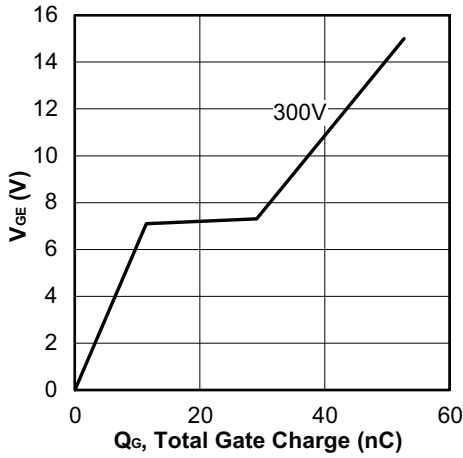

Fig. 26 - Typical Gate Charge vs.  $V_{GE}$   
 $I_{CE} = 5 \text{ A}$

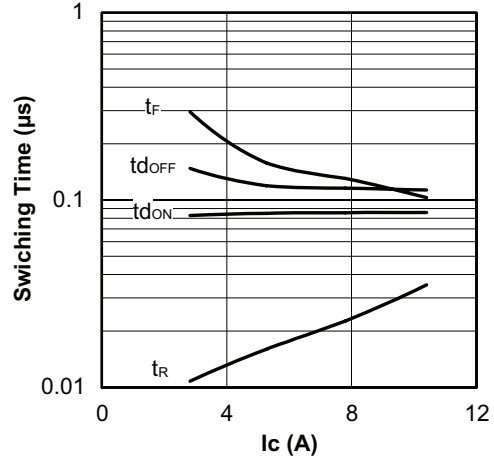

Fig. 29 - Typical Switching Time vs.  $I_C$   
 $T_J = 125 \text{ }^\circ\text{C}$ ;  $L = 500 \text{ } \mu\text{H}$ ;  $V_{CE} = 300 \text{ V}$ ;  $R_G = 22 \text{ } \Omega$ ;  $V_{GE} = 15 \text{ V}$

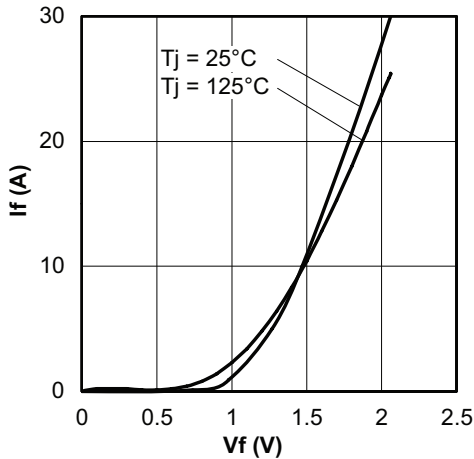

Fig. 27 - Typical Diode Forward Characteristics  
 $t_p = 80 \text{ } \mu\text{s}$

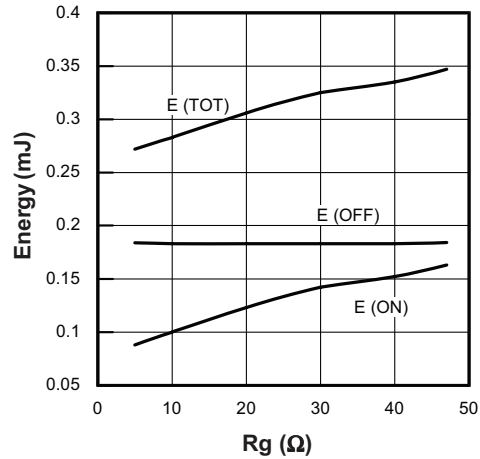

Fig. 30 - Typical Energy Loss vs.  $R_G$   
 $T_J = 125 \text{ }^\circ\text{C}$ ;  $L = 500 \text{ } \mu\text{H}$ ;  $V_{CE} = 300 \text{ V}$ ;  $I_{CE} = 5 \text{ A}$ ;  $V_{GE} = 15 \text{ V}$

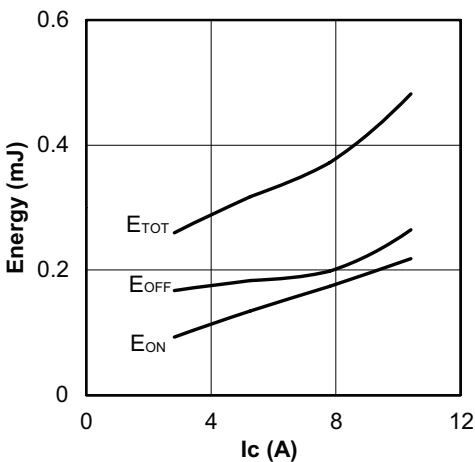

Fig. 28 - Typical Energy Loss vs.  $I_C$   
 $T_J = 125 \text{ }^\circ\text{C}$ ;  $L = 500 \text{ } \mu\text{H}$ ;  $V_{CE} = 300 \text{ V}$ ;  $R_G = 22 \text{ } \Omega$ ;  $V_{GE} = 15 \text{ V}$

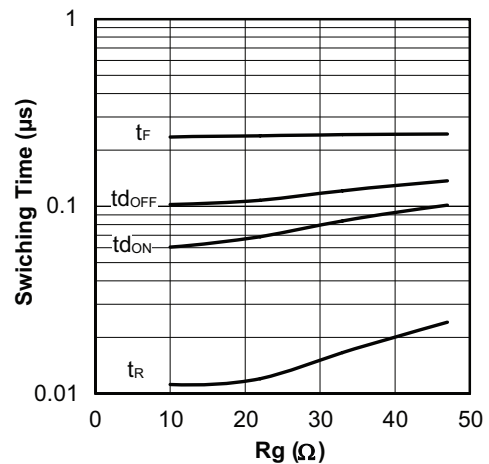

Fig. 31 - Typical Switching Time vs.  $R_G$   
 $T_J = 125 \text{ }^\circ\text{C}$ ;  $L = 500 \text{ } \mu\text{H}$ ;  $V_{CE} = 300 \text{ V}$ ;  $I_{CE} = 5 \text{ A}$ ;  $V_{GE} = 15 \text{ V}$

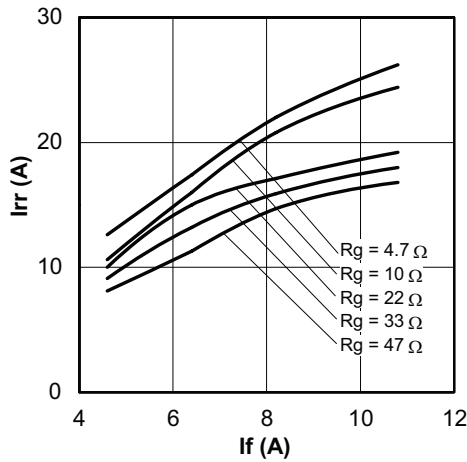

Fig. 32 - Typical Diode  $I_{RR}$  vs.  $I_F$   
 $T_J = 125^\circ\text{C}$

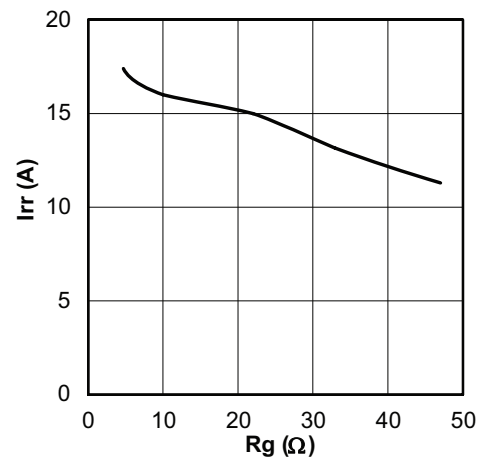

Fig. 33 - Typical Diode  $I_{RR}$  vs.  $R_G$   
 $T_J = 125^\circ\text{C}$ ;  $I_F = 5\text{ A}$

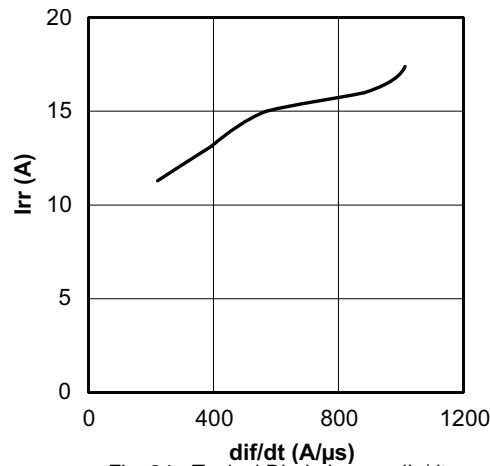

Fig. 34 - Typical Diode  $I_{RR}$  vs.  $\text{di}/\text{dt}$   
 $V_{CC} = 300\text{ V}$ ;  $V_{GE} = 15\text{ V}$ ;  $I_{CE} = 5\text{ A}$ ;  $T_J = 125^\circ\text{C}$

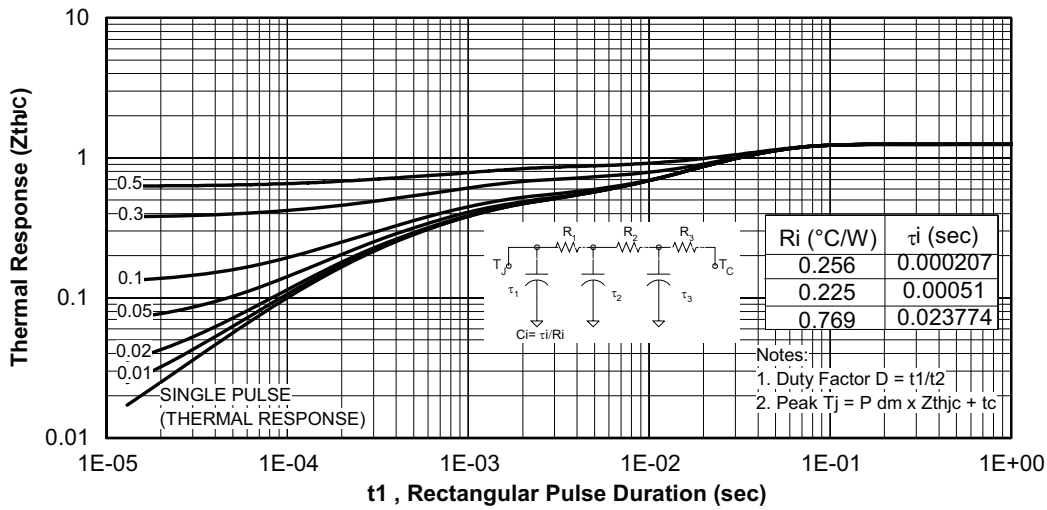

Fig. 35 - Maximum Transient Thermal Impedance, Junction to Case (Brake IGBT)

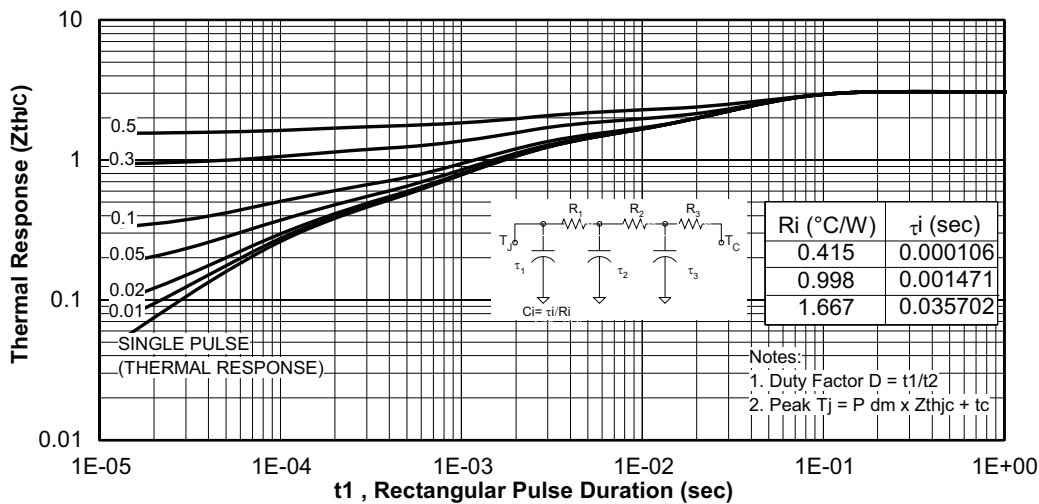

Fig. 36 - Maximum Transient Thermal Impedance, Junction to Case (Brake Diode)

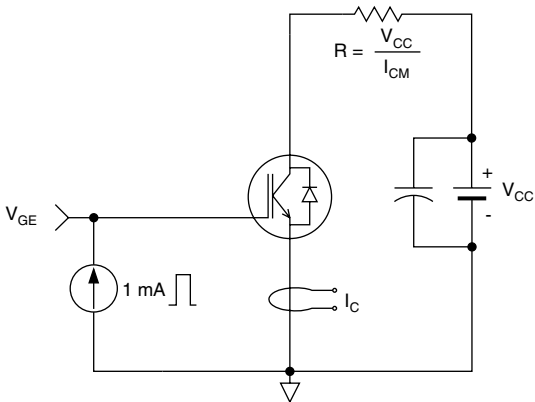

Fig. C.T.1 - Gate Charge Circuit (turn-off)

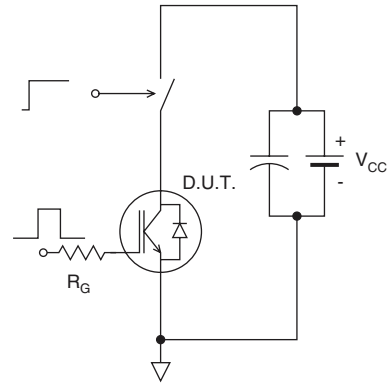

Fig. C.T.3 - S.C. SOA Circuit

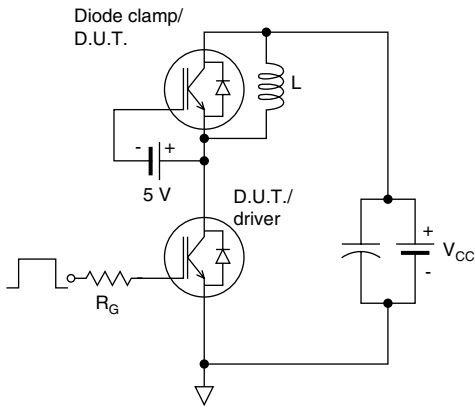

Fig. C.T.2 - RBSOA Circuit

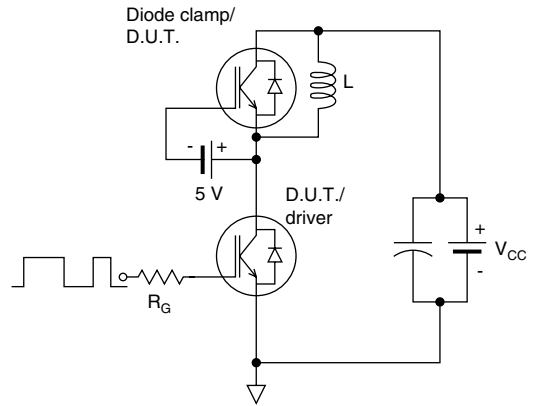

Fig. C.T.4 - Switching Loss Circuit

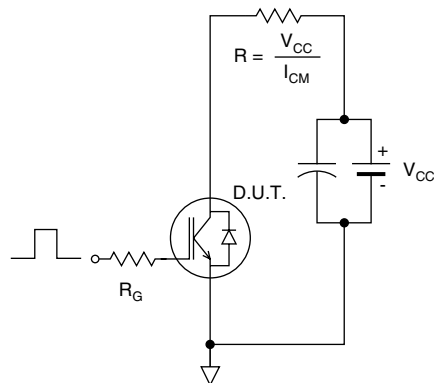
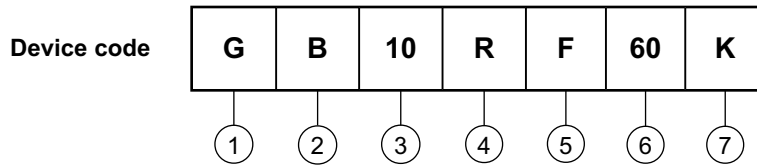

Fig. C.T.5 - Resistive Load Circuit

## ORDERING INFORMATION TABLE



- 1** - Insulated Gate Bipolar Transistor (IGBT)
- 2** - B = IGBT Generation 5 NPT
- 3** - Current rating (10 = 10 A)
- 4** - Circuit configuration  
(R = Three phase bridge-brake-inverter with thermistor)
- 5** - Package indicator (F = ECONO2)
- 6** - Voltage rating (60 = 600 V)
- 7** - Speed/type (K = Ultrafast IGBT/Speed 8 to 60 kHz)

## CIRCUIT CONFIGURATION

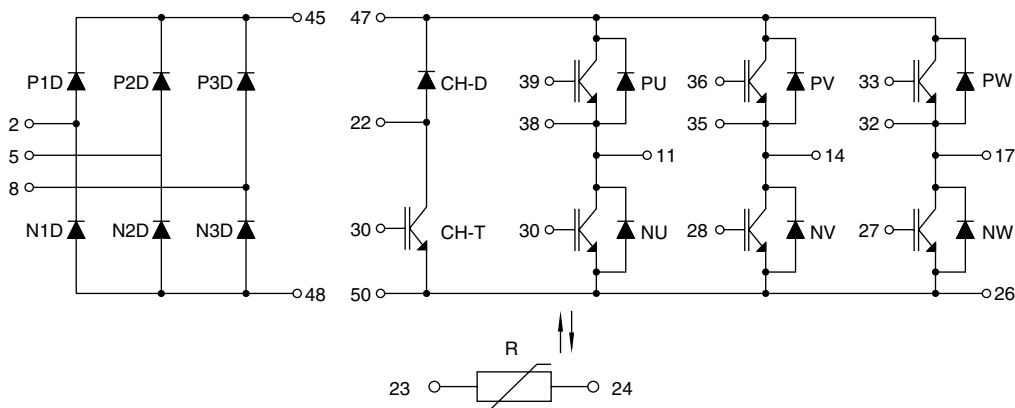

### LINKS TO RELATED DOCUMENTS

Dimensions	<a href="http://www.vishay.com/doc?95083">http://www.vishay.com/doc?95083</a>
Part marking information	<a href="http://www.vishay.com/doc?95071">http://www.vishay.com/doc?95071</a>



## Disclaimer

All product specifications and data are subject to change without notice.

Vishay Intertechnology, Inc., its affiliates, agents, and employees, and all persons acting on its or their behalf (collectively, "Vishay"), disclaim any and all liability for any errors, inaccuracies or incompleteness contained herein or in any other disclosure relating to any product.

Vishay disclaims any and all liability arising out of the use or application of any product described herein or of any information provided herein to the maximum extent permitted by law. The product specifications do not expand or otherwise modify Vishay's terms and conditions of purchase, including but not limited to the warranty expressed therein, which apply to these products.

No license, express or implied, by estoppel or otherwise, to any intellectual property rights is granted by this document or by any conduct of Vishay.

The products shown herein are not designed for use in medical, life-saving, or life-sustaining applications unless otherwise expressly indicated. Customers using or selling Vishay products not expressly indicated for use in such applications do so entirely at their own risk and agree to fully indemnify Vishay for any damages arising or resulting from such use or sale. Please contact authorized Vishay personnel to obtain written terms and conditions regarding products designed for such applications.

Product names and markings noted herein may be trademarks of their respective owners.