

1A LDO REGULATOR (Operating Voltage up to 24V)

NO.EA-184-080910

OUTLINE

The R1501x series are CMOS-based positive voltage regulator (VR) ICs. The R1501xxxxB has features of high input voltage operating, 1A output current drive, and low supply current.

A DMOS transistor is used for the driver, high voltage operating and low on resistance (0.6Ω at $V_{OUT}=10V$) device is realized. A standard regulator circuit with a current limit circuit and a thermal shutdown circuit are built in the R1501x series.

As the operating temperature range is from $-40^{\circ}C$ to $105^{\circ}C$ and maximum input voltage is up to 24V, the R1501x series are suitable for the constant voltage source for digital home appliances and car accessories.

The regulator output voltage is fixed in the R1501x. Output voltage accuracy is $\pm 2.0\%$ and output voltage range is from 3.0V to 12.0V with a step of 0.1V, and from 12.5V to 18.0V with a step of 0.5V. The chip enable pin realizes ultra low supply current standby mode.

Since the packages for these ICs are the HSOP-6J for high density mounting of the ICs on boards, and the TO-252-5-P2.

*) The DMOS (Double Diffused MOS) transistor adopted by R1501x is characterized by a double diffusion structure which comprises a low density n-type (channel) diffused layer and a high density p-type (sources) diffused layer from the edge of the gate electrode. The R1501x series possess outstanding properties of high operating voltage and low on-resistance, which have been achieved by the channel length scaled down to submicron dimensions and decreased thickness of the gate oxide film.

FEATURES

- Input Voltage Range3.0V to 24.0V
- Supply CurrentTyp. $70\mu A$
- Standby CurrentTyp. $0.1\mu A$
- Ripple RejectionTyp. 60dB ($V_{OUT}=5.0V$)
- Temperature-Drift Coefficient of Output VoltageTyp. $\pm 100ppm/^{\circ}C$
- Output Current.....Min. 1A
- Line RegulationTyp. 0.05%/V
- Output Voltage Accuracy $\pm 2\%$
- Packages.....HSOP-6J, TO-252-5-P2
- Output Voltage.....Stepwise setting with a step of 0.1V in the range of 3.0V to 12.0V, and with a step of 0.5V in the range of 12.5V to 18.0V is possible.
- Built-in Current Limit Circuit
- Built-in Fold-Back Circuit
- Built-in Thermal Shutdown Circuit
- Operating Temperature range $-40^{\circ}C$ to $105^{\circ}C$

APPLICATIONS

- Power source for home appliances such as refrigerators, rice cookers, electric water warmers, etc.
- Power source for car audio equipment, car navigation system, ETC system, etc.
- Power source for notebook PCs, digital TVs, cordless phones, and private LAN system, etc.
- Power source for office equipment machines such as copiers, printers, facsimiles, scanners, projectors, etc.

BLOCK DIAGRAMS

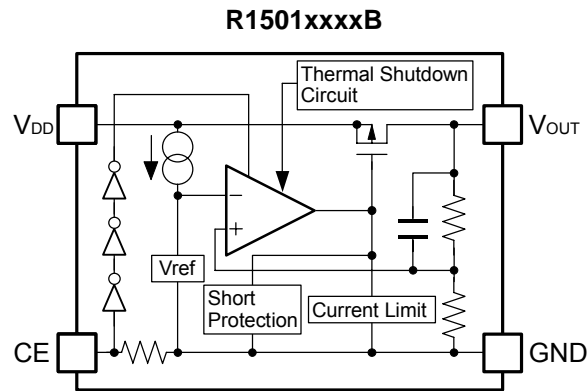

SELECTION GUIDE

The output voltage, the active type, and the taping type for the ICs can be selected at the user's request. The selection can be made with designating the part number as shown below;

R1501xxxxB-xx-x ← Part Number
 ↑ ↑ ↑ ↑ ↑
 a b c d e

Code	Contents
a	Designation of Package Type: S: HSOP-6J J: TO-252-5-P2
b	Setting Output Voltage (V_{OUT}): Stepwise setting with a step of 0.1V in the range of 3.0V to 12.0V, and with a step of 0.5V in the range of 12.5V to 18.0V is possible.
c	Designation of Active Type: B: active high
d	Designation of Taping Type: E2: HSOP-6J T1: TO-252-5-P2 (Refer to Taping Specifications)
e	Designation of composition of pin plating: -F: Lead free solder plating (HSOP-6J, TO-252-5-P2)

PIN CONFIGURATIONS

• HSOP-6J

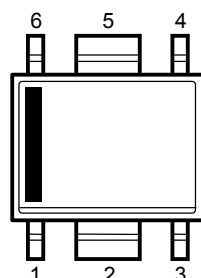

• TO-252-5-P2

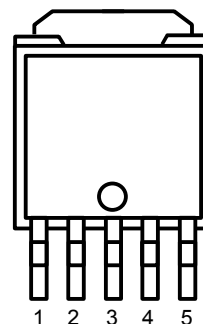

PIN DESCRIPTIONS

• HSOP-6J

Pin No.	Symbol	Description
1	V_{DD}	Input Pin
2	GND*	Ground Pin
3	GND*	Ground Pin
4	CE	Chip Enable Pin ("H" Active)
5	GND*	Ground Pin
6	V_{OUT}	Output Pin

*) No.2, No.3 and No.5 pins must be wired short each other and connected to the GND plane when it is mounted on board.

• TO-252-5-P2

Pin No.	Symbol	Description
1	V_{DD}	Input Pin
2	GND*	Ground Pin
3	GND*	Ground Pin
4	CE	Chip Enable Pin ("H" Active)
5	V_{OUT}	Output Pin

*) No.2 and No.3 pins must be wired short each other and connected to the GND plane when it is mounted on board.

ABSOLUTE MAXIMUM RATINGS

Symbol	Item	Rating	Unit
V_{IN}	Input Voltage	-0.3 to 36	V
V_{CE}	Input Voltage (CE Pin)	$-0.3 \text{ to } V_{IN} + 0.3 \leq 36$	V
V_{OUT}	Output Voltage	$-0.3 \text{ to } V_{IN} + 0.3 \leq 36$	V
I_{OUT}	Output Current	2.0	A
P_D	Power Dissipation (HSOP-6J)*	1700	mW
	Power Dissipation (TO-252-5-P2)*	1900	
T_{opt}	Operating Temperature Range	-40 to 105	°C
T_j	Operating Junction Temperature Range	-40 to 125	°C
T_{stg}	Storage Temperature Range	-55 to 125	°C

*) For Power Dissipation, please refer to PACKAGE INFORMATION to be described.

ABSOLUTE MAXIMUM RATINGS

Electronic and mechanical stress momentarily exceeded absolute maximum ratings may cause the permanent damages and may degrade the life time and safety for both device and system using the device in the field.

The functional operation at or over these absolute maximum ratings is not assured.

RECOMMENDED OPERATING CONDITIONS (ELECTRICAL CHARACTERISTICS)

All of electronic equipment should be designed that the mounted semiconductor devices operate within the recommended operating conditions. The semiconductor devices cannot operate normally over the recommended operating conditions, even if when they are used over such conditions by momentary electronic noise or surge.

And the semiconductor devices may receive serious damage when they continue to operate over the recommended operating conditions.

ELECTRICAL CHARACTERISTICS

• R1501xxxxB

$V_{IN}=V_{OUT}+1.0V$, $V_{CE}=V_{IN}$, unless otherwise noted.

The specification in is checked and guaranteed by design engineering at $-40^{\circ}\text{C} \leq T_{opt} \leq 105^{\circ}\text{C}$.

$T_{opt}=25^{\circ}\text{C}$

Symbol	Item	Conditions	Min.	Typ.	Max.	Unit
V_{IN}	Input Voltage		3		24	V
I_{SS}	Supply Current	$V_{IN}=24V$, $I_{OUT}=0A$		70	160	μA
$I_{standby}$	Standby Current	$V_{IN}=24V$, $V_{CE}=0V$		0.1	1.0	μA
V_{OUT}	Output Voltage	$I_{OUT}=1\text{mA}$	$T_{opt}=25^{\circ}\text{C}$	$\times 0.98$	$\times 1.02$	V
			$-40^{\circ}\text{C} \leq T_{opt} \leq 105^{\circ}\text{C}$	$\times 0.965$	$\times 1.035$	V
I_{OUT}	Output Current		1			A
$\frac{\Delta V_{OUT}}{\Delta I_{OUT}}$	Load Regulation	$0.1\text{mA} \leq I_{OUT} \leq 200\text{mA}$		25	60	mV
		$0.1\text{mA} \leq I_{OUT} \leq 1A$ *guaranteed by design engineering		125	300	mV
$\frac{\Delta V_{OUT}}{\Delta V_{IN}}$	Line Regulation	$V_{OUT}+1V \leq V_{IN} \leq 24V$, $I_{OUT}=10\text{mA}$		0.05	0.1	%/V
V_{DIF}	Dropout Voltage	$I_{OUT}=200\text{mA}$	$3.0V \leq V_{OUT} < 5.0V$	0.135	0.225	V
			$5.0V \leq V_{OUT} < 9.0V$	0.115	0.180	
			$9.0V \leq V_{OUT} < 12.0V$	0.095	0.155	
			$12.0V \leq V_{OUT} \leq 18.0V$	0.090	0.140	
		$I_{OUT}=1A$ *guaranteed by design engineering	$3.0V \leq V_{OUT} < 5.0V$	0.675	1.125	V
			$5.0V \leq V_{OUT} < 9.0V$	0.575	0.900	
			$9.0V \leq V_{OUT} < 12.0V$	0.475	0.775	
			$12.0V \leq V_{OUT} \leq 18.0V$	0.450	0.700	
$\frac{\Delta V_{OUT}}{\Delta T_{opt}}$	Output Voltage Temperature Coefficient	$I_{OUT}=1\text{mA}$ $-40^{\circ}\text{C} \leq T_{opt} \leq 105^{\circ}\text{C}$		± 100		ppm/ $^{\circ}\text{C}$
I_{lim}	Short Current Limit	$V_{OUT}=0V$		65		mA
RR	Ripple Rejection	$f=1\text{kHz}$, Ripple 0.5Vp-p, $I_{OUT}=100\text{mA}$, $V_{IN}=V_{OUT}+2V$	$V_{OUT} \leq 6.0V$	60		dB
			$V_{OUT} > 6.0V$	50		
V_{CEH}	CE Input Voltage "H"		2.0		V_{IN}	V
V_{CEL}	CE Input Voltage "L"		0		0.5	V
T_{TSD}	Thermal Shutdown Temperature	Junction Temperature		160		$^{\circ}\text{C}$
T_{TSR}	Thermal Shutdown Released Temperature	Junction Temperature		135		$^{\circ}\text{C}$

All of unit are tested and specified under load conditions such that $T_{opt}=25^{\circ}\text{C}$ except for Output Voltage Temperature Coefficient, Ripple Rejection, Thermal Shutdown Temperature, Thermal Shutdown Released Temperature, Load Regulation at $0.1\text{mA} \leq I_{OUT} \leq 1A$, Dropout Voltage at $I_{OUT}=1A$.

TYPICAL APPLICATION

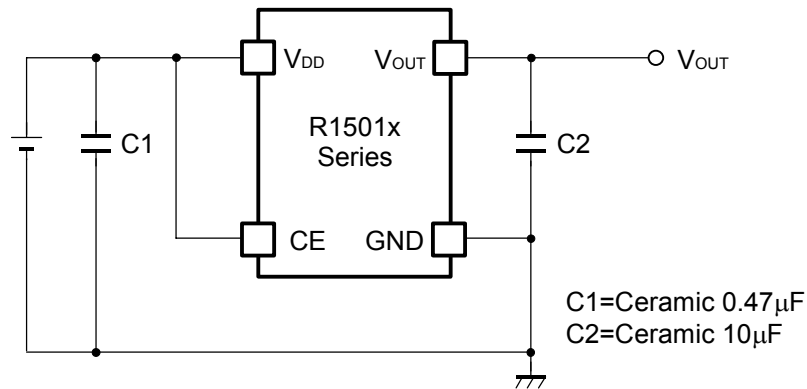

(External Components)

C2: Ceramic 10 μ F MURATA: GRM32DB31E106K (size: 3225)

TECHNICAL NOTES

When using these ICs, consider the following points:

Phase Compensation

In these ICs, phase compensation is made for securing stable operation even if the load current is varied. For this purpose, use a capacitor C2 with good frequency characteristics and ESR (Equivalent Series Resistance).

If you use a tantalum type capacitor and ESR value of the capacitor is large, output might be unstable. Evaluate your circuit with considering frequency characteristics.

Depending on the capacitor size, manufacturer, and part number, the bias characteristics and temperature characteristics are different. Evaluate the circuit with actual using capacitors.

PCB Layout

Make V_{DD} and GND lines sufficient. If their impedance is high, noise pickup or unstable operation may result. Connect a capacitor C1 with a capacitance value as much as 0.47 μ F or more between V_{DD} and GND pin, and as close as possible to the pins.

Set external components, especially the output capacitor C2, as close as possible to the ICs, and make wiring as short as possible.

No.2 pin, No.3 pin and No.5 pin of HSOP-6J package must be wired to the GND plane when it is mounted on board. No.2 pin and No.3 pin of TO-252-5-P2 package must be wired to the GND plane when it is mounted on board.

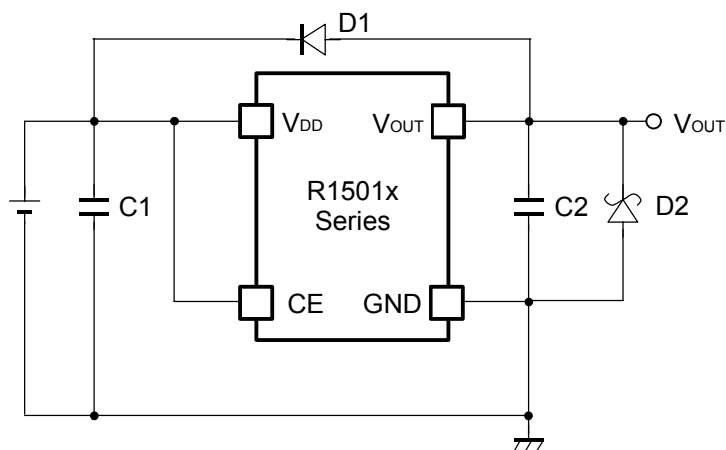
TYPICAL APPLICATION FOR PREVENTING IC DESTRUCTION

C1: 0.47 μ F or more (preventing for unstable operation)

C2: 10 μ F or more (preventing for unstable operation)

D1: If V_{OUT} pin could be higher than V_{IN} pin, D1 is necessary.

D2: If V_{OUT} pin could be lower than GND pin, SBD is necessary.

Note: Do not force the voltage to V_{OUT} pin.

TEST CIRCUITS

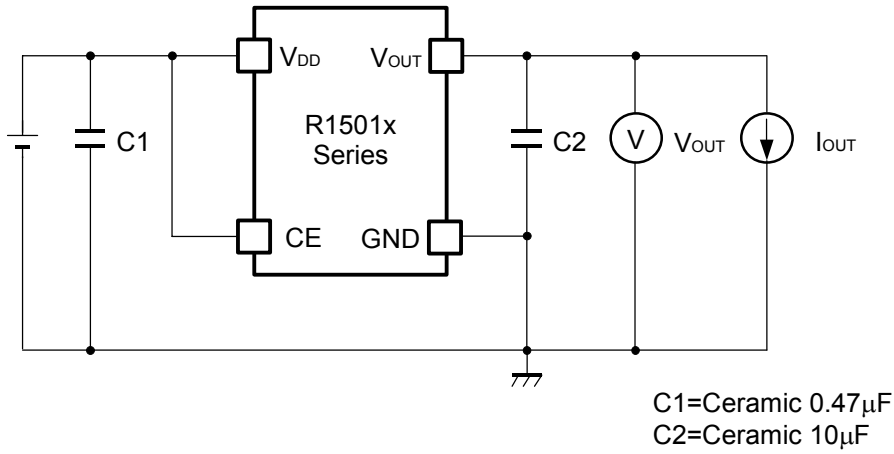

Basic Test Circuit

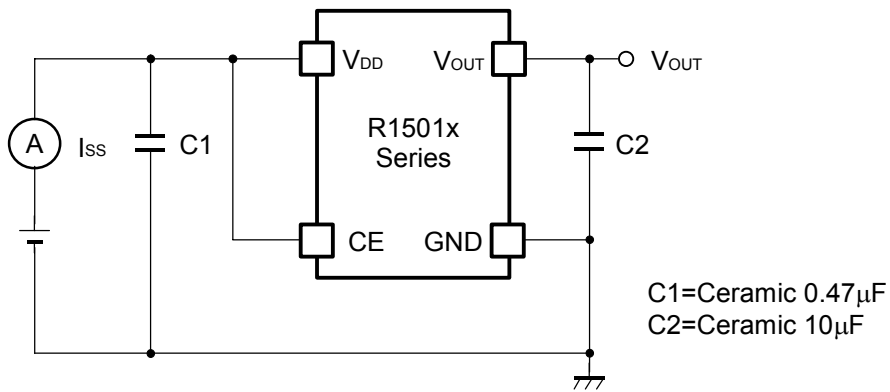

Test Circuit for Supply Current

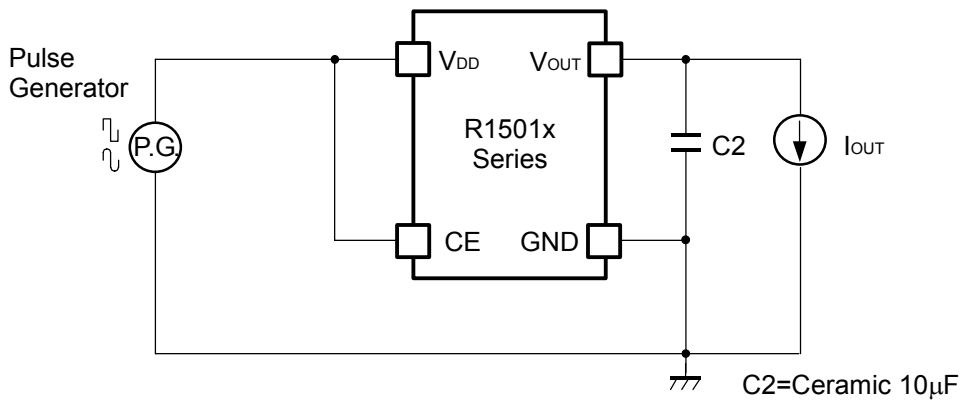

Test Circuit for Ripple Rejection, Input Transient Response

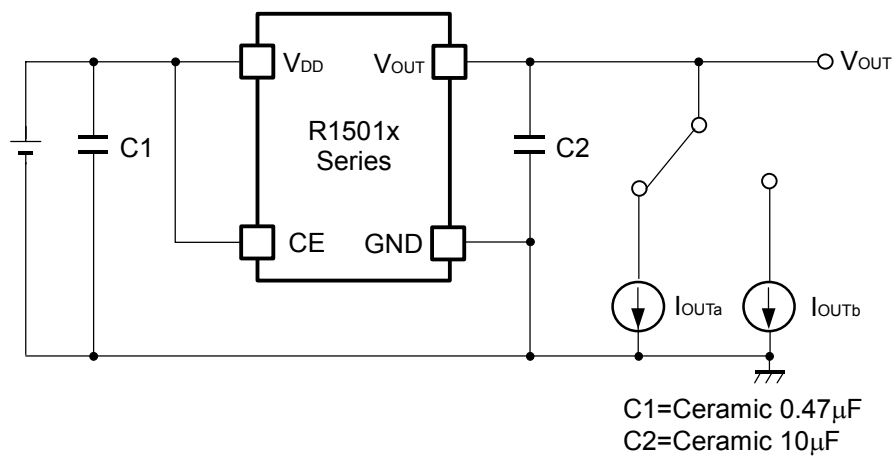

Test Circuit for Load Transient Response

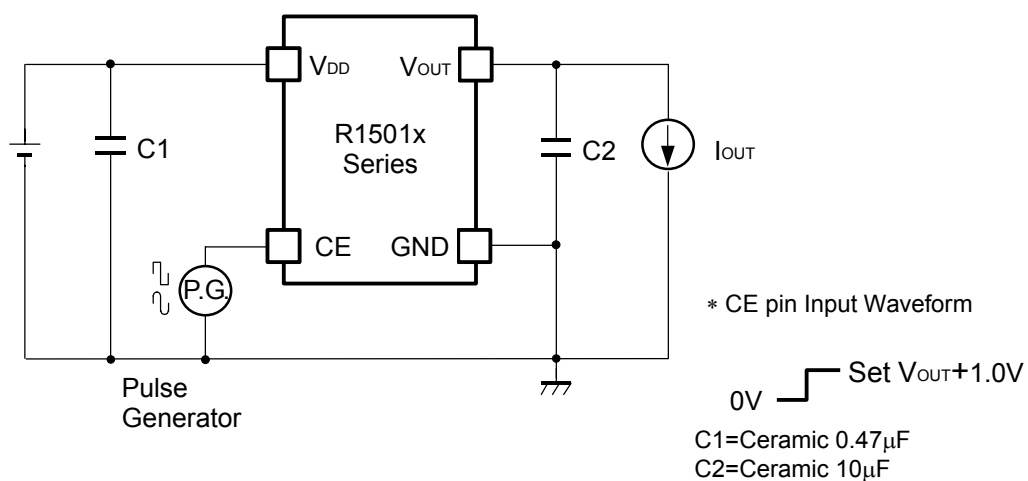

Test Circuit for Turn On Speed with CE pin

TYPICAL CHARACTERISTICS

*T_{opt}=25°C, unless otherwise noted.

1) Output Voltage vs. Output Current (C1=Ceramic 0.47μF, C2=Ceramic 10μF)

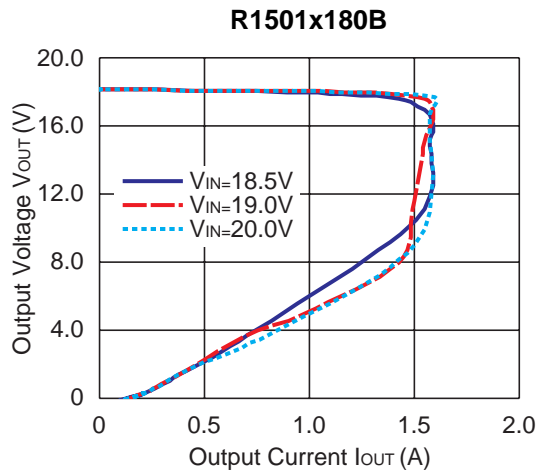
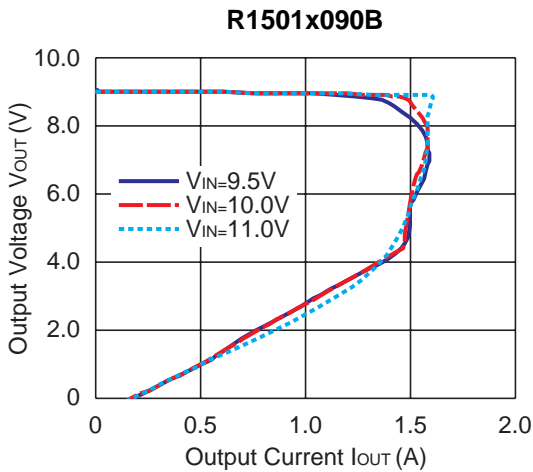
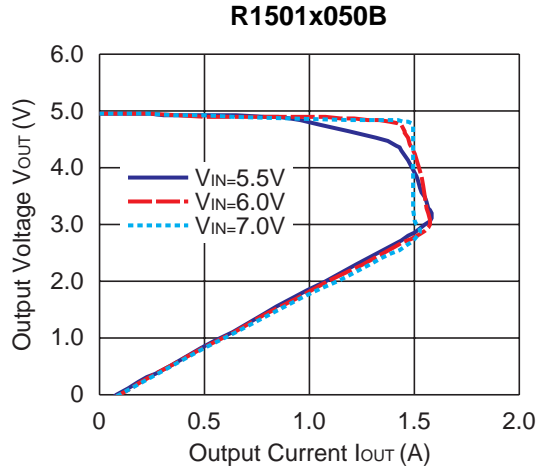
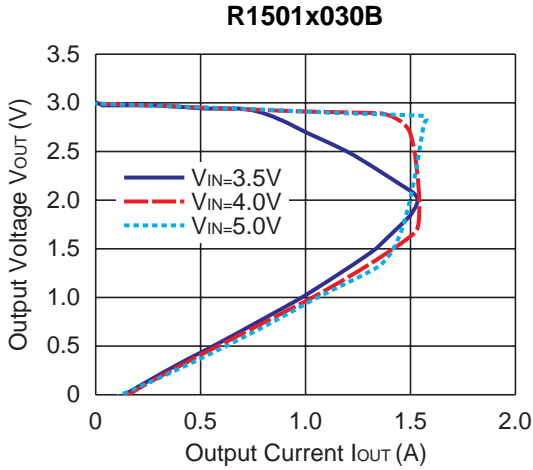

2) Output Voltage vs. Input Voltage (C1=Ceramic 0.47μF, C2=Ceramic 10μF)

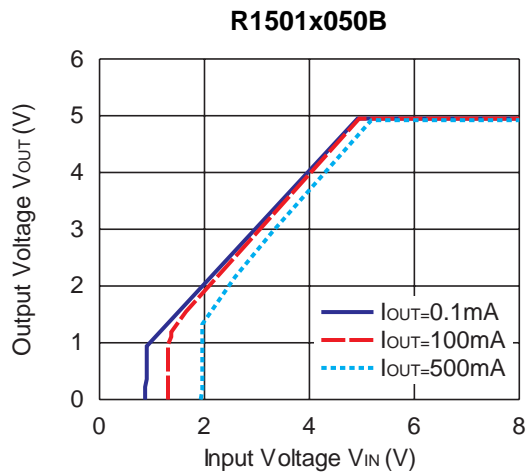
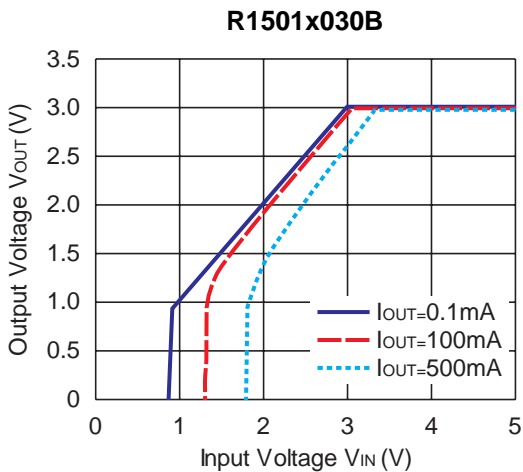

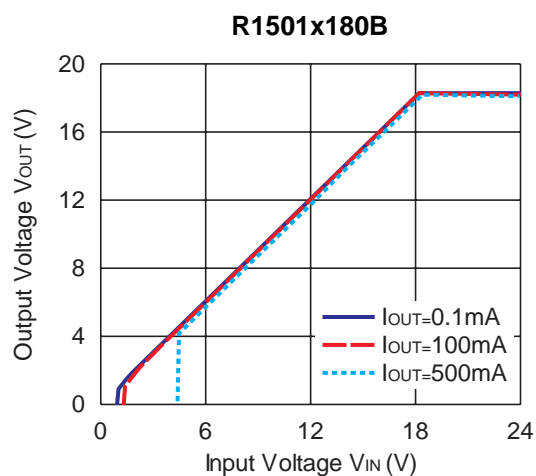
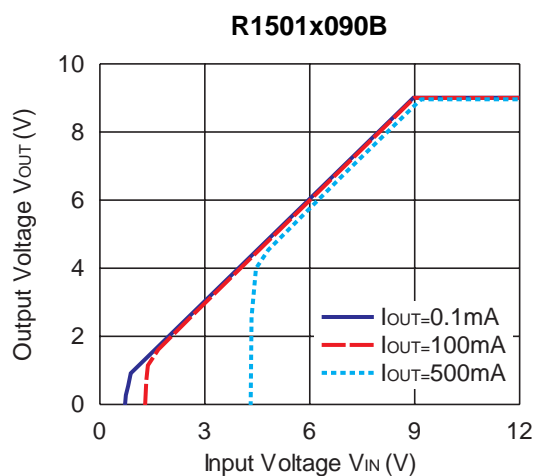

3) Supply Current vs. Input Voltage (C1=Ceramic 0.47 μ F, C2=Ceramic 10 μ F)

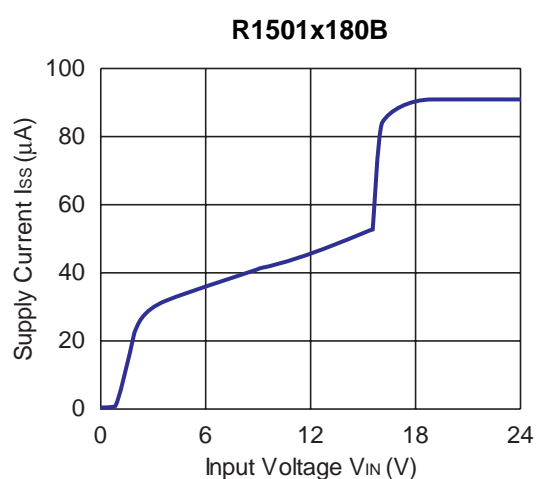
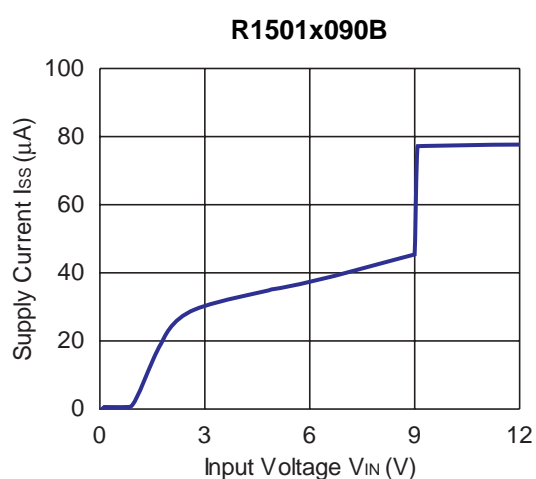
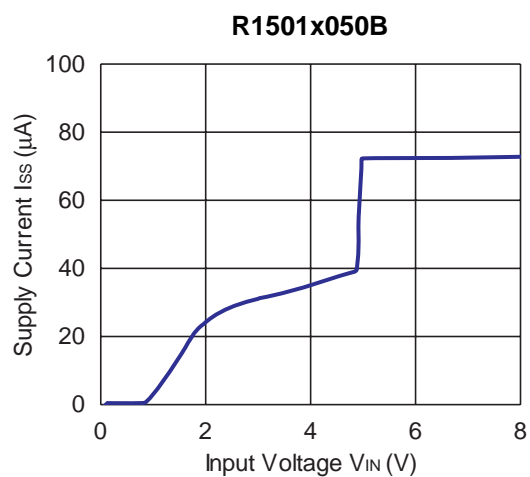
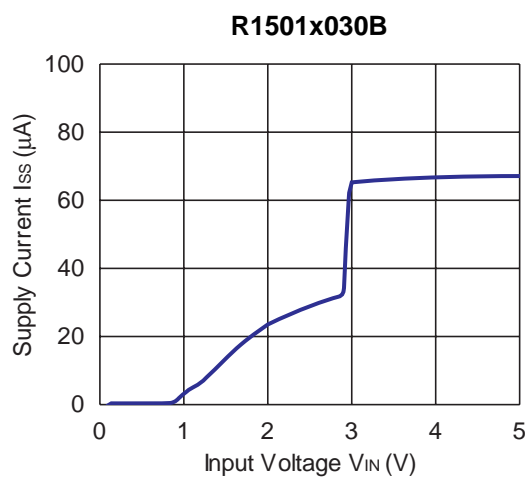

4) Output Voltage vs. Temperature (C1=Ceramic 0.47 μ F, C2=Ceramic 10 μ F, I_{OUT}=1mA)

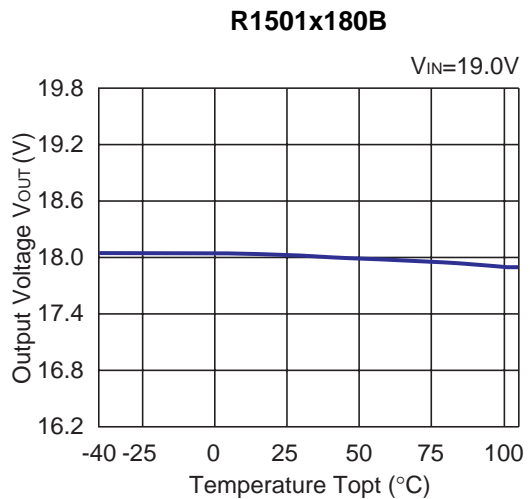
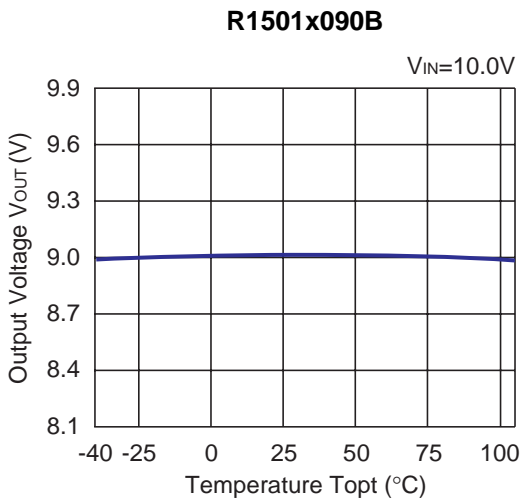
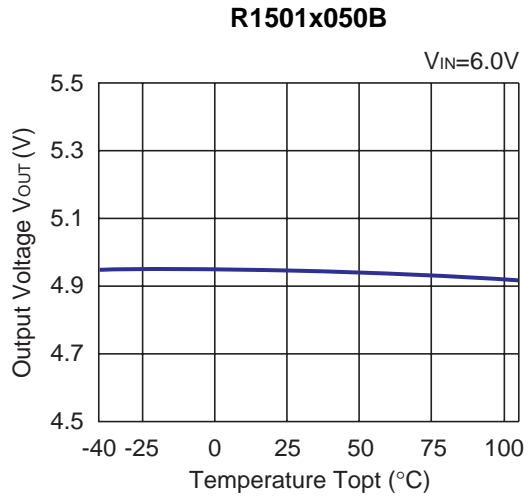
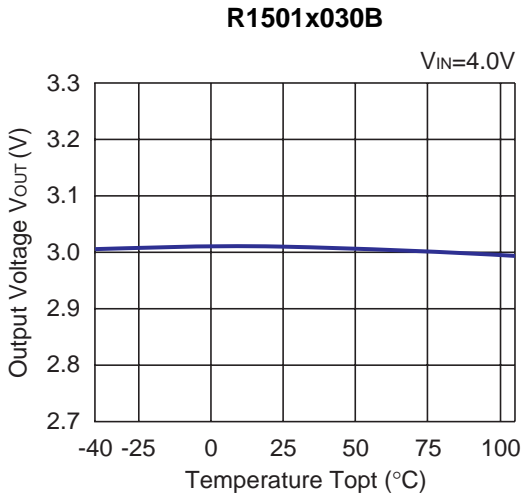

5) Supply Current vs. Temperature (C1=Ceramic 0.47 μ F, C2=Ceramic 10 μ F, I_{OUT}=0mA)

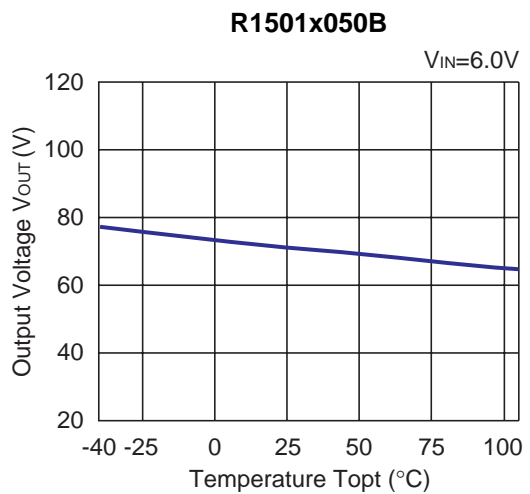
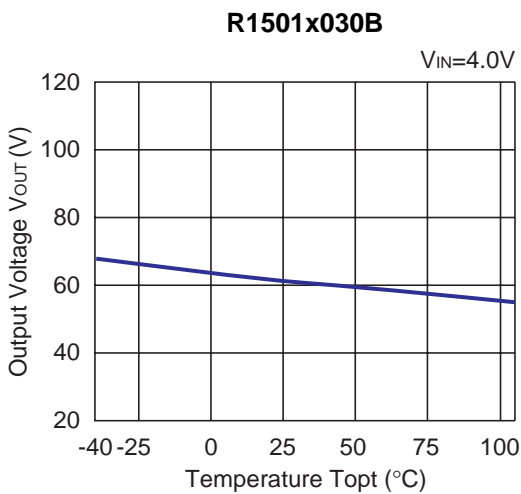

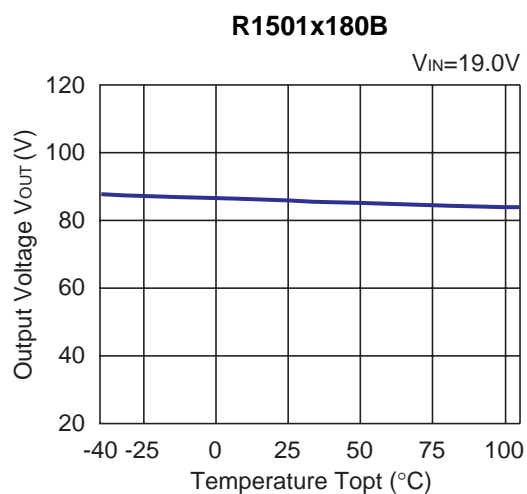
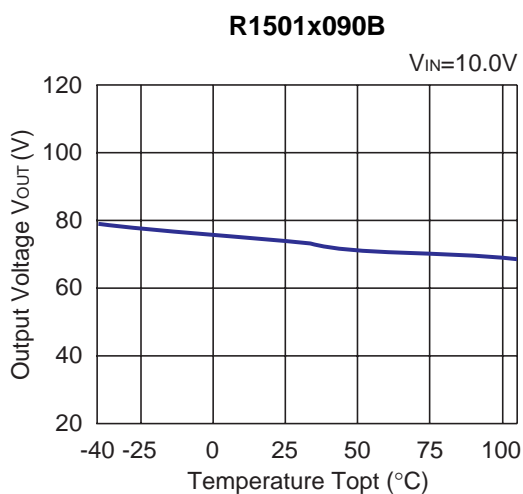

6) Dropout Voltage vs. Output Current (C1=Ceramic 0.47μF, C2=Ceramic 10μF)

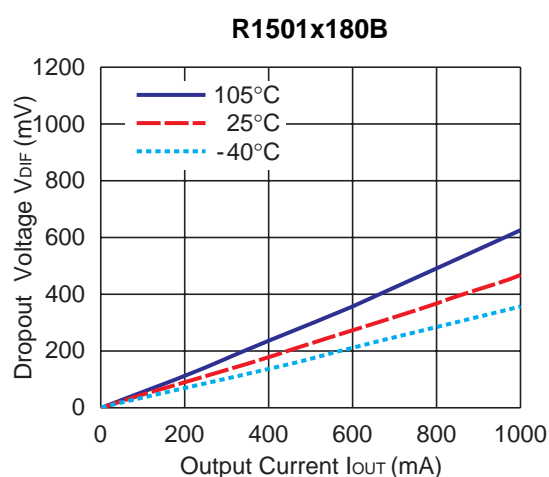
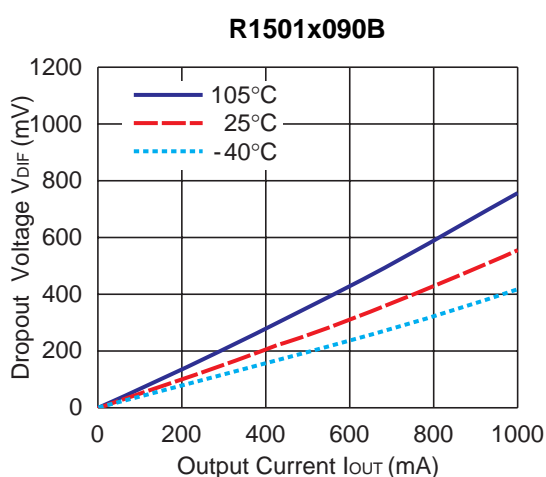
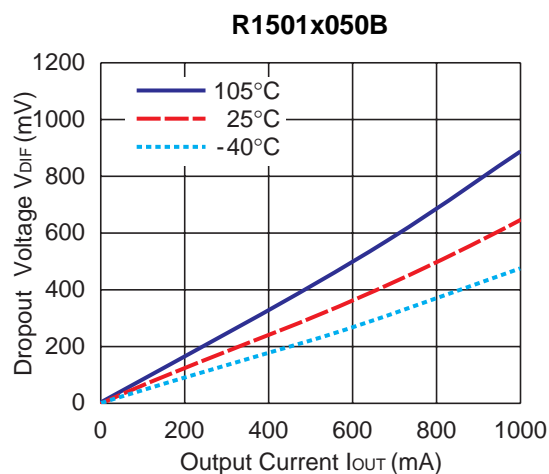
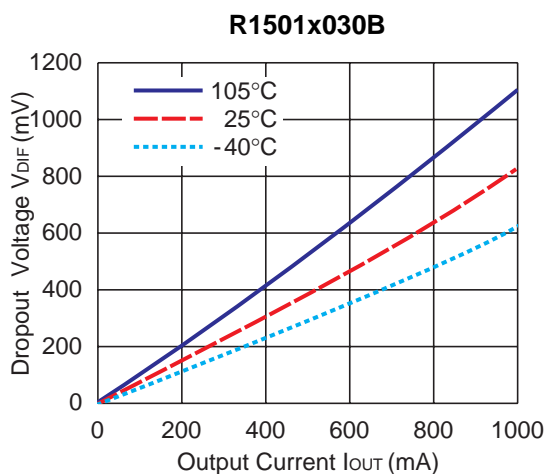

7) Dropout Voltage vs. Set Output Voltage (C1=Ceramic 0.47 μ F, C2=Ceramic 10 μ F)

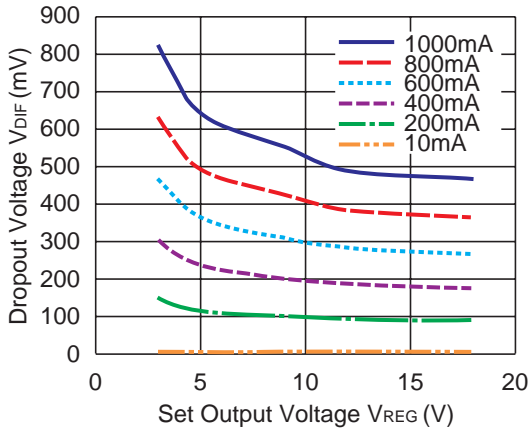

8) Ripple Rejection vs. Input Bias Voltage (C1=none, C2=Ceramic 10 μ F, I_{OUT} =100mA)

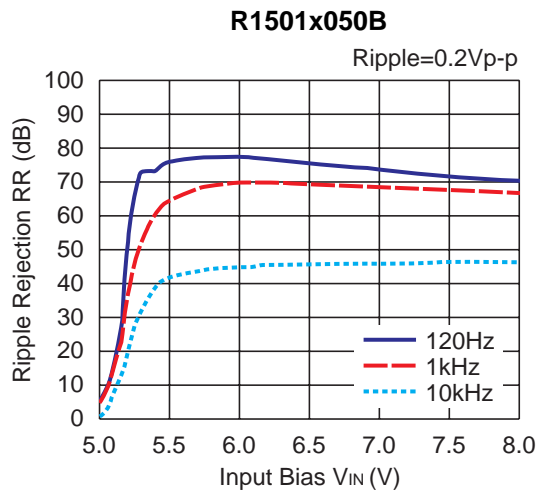
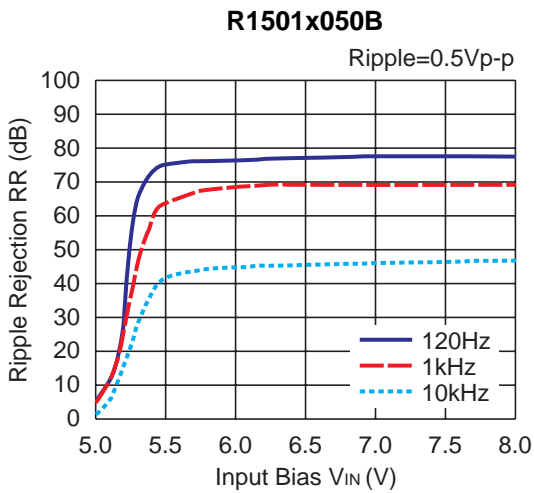
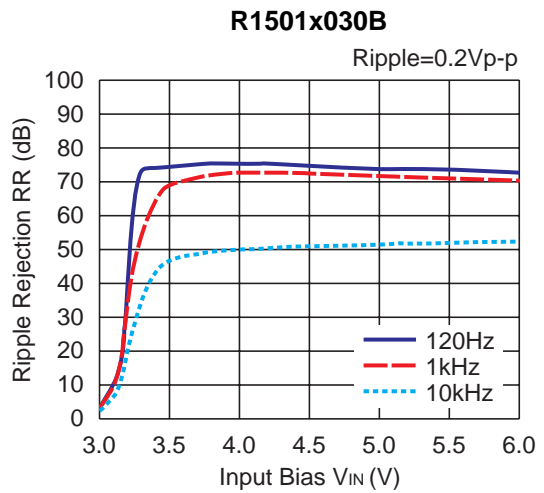
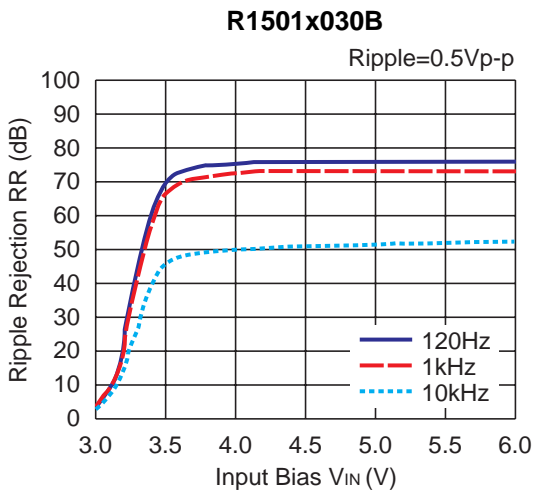

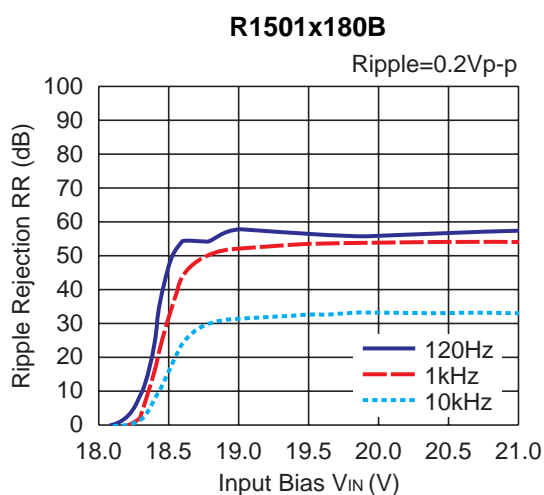
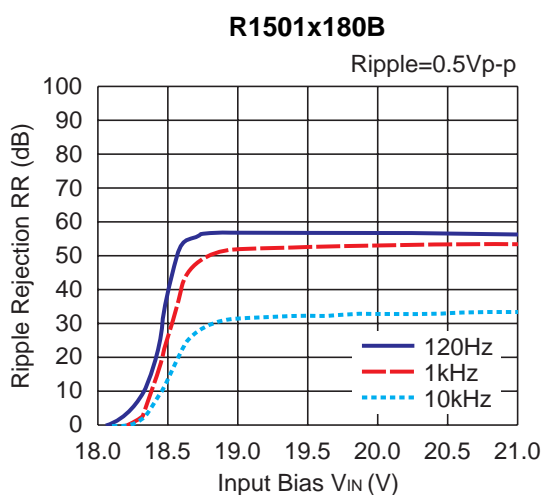
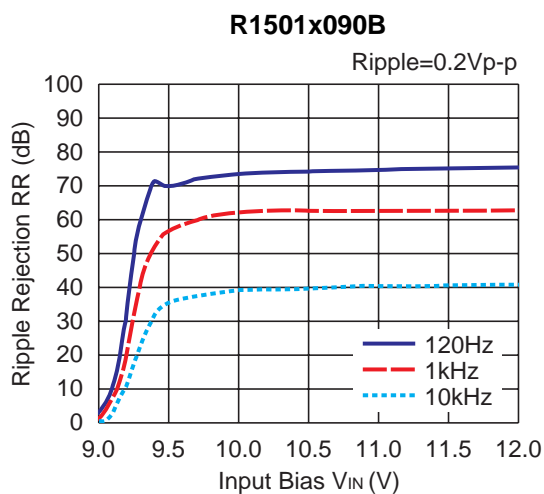
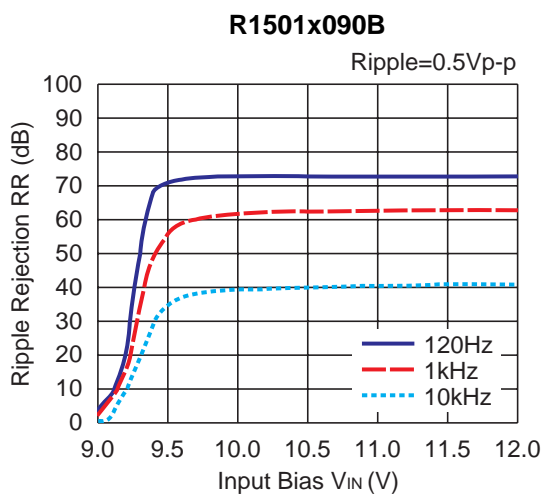

9) Ripple Rejection vs. Frequency (C1=none, C2=Ceramic 10 μ F, Ripple=0.5V_{p-p})

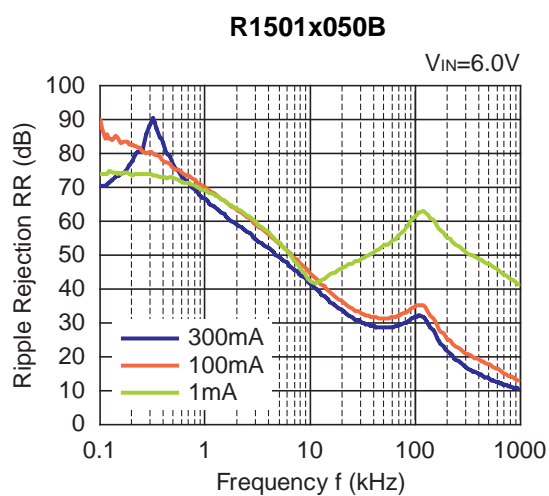
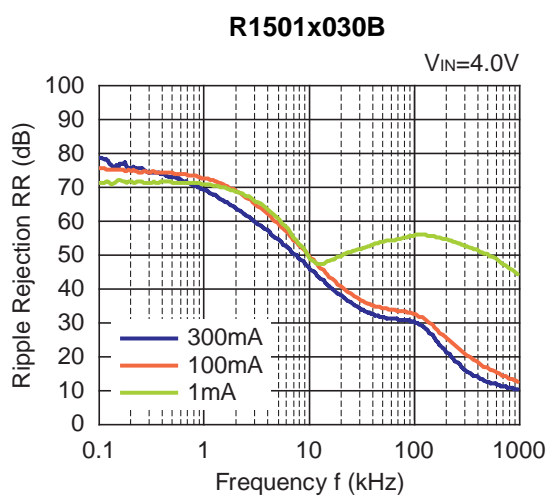

R1501x090B

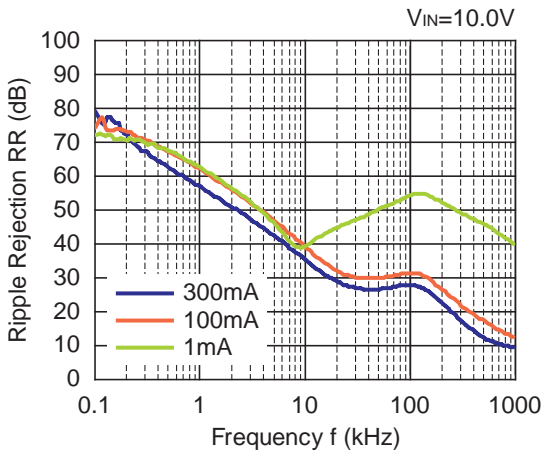

R1501x180B

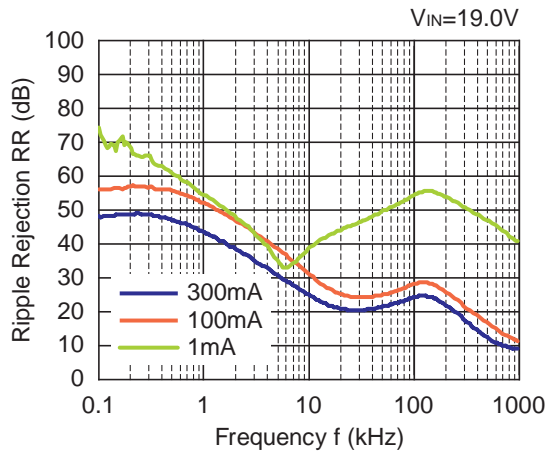

10) Input Transient Response (C1=none, C2=Ceramic 10μF, I_{OUT}=100mA, tr=tf=10μs)

R1501x030B

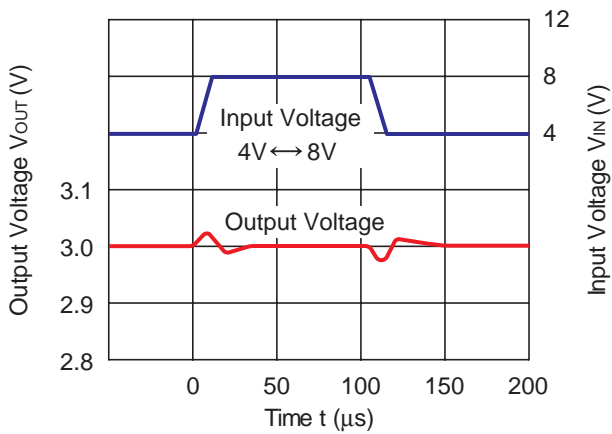

R1501x050B

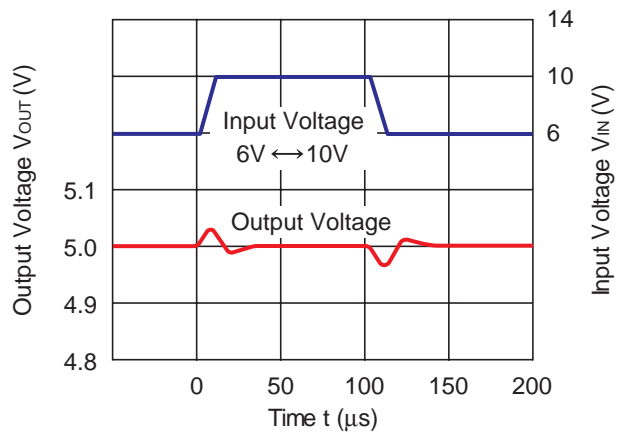

R1501x090B

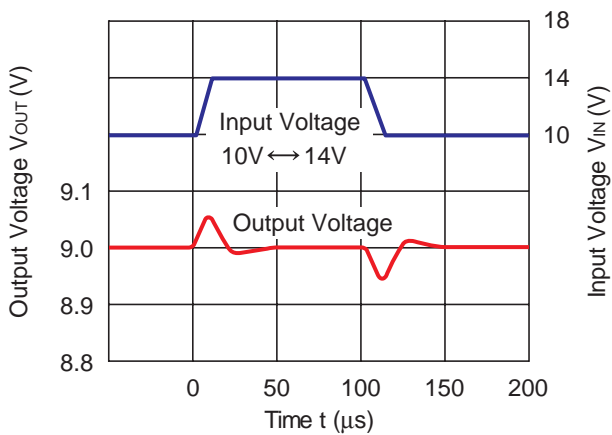

R1501x180B

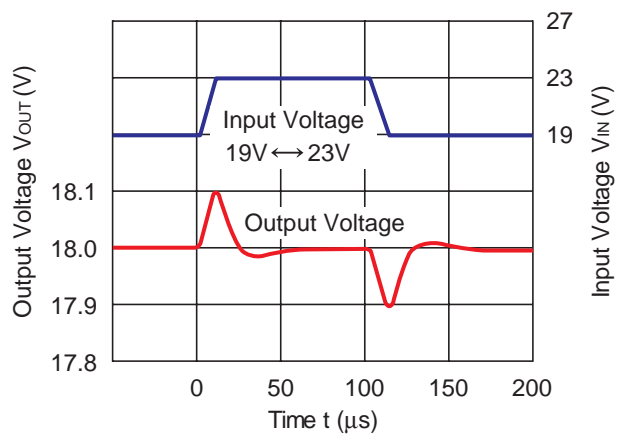

11) Load Transient Response (C_1 =Ceramic $0.47\mu\text{F}$, C_2 =Ceramic $10\mu\text{F}$, $t_r=t_f=0.5\mu\text{s}$)

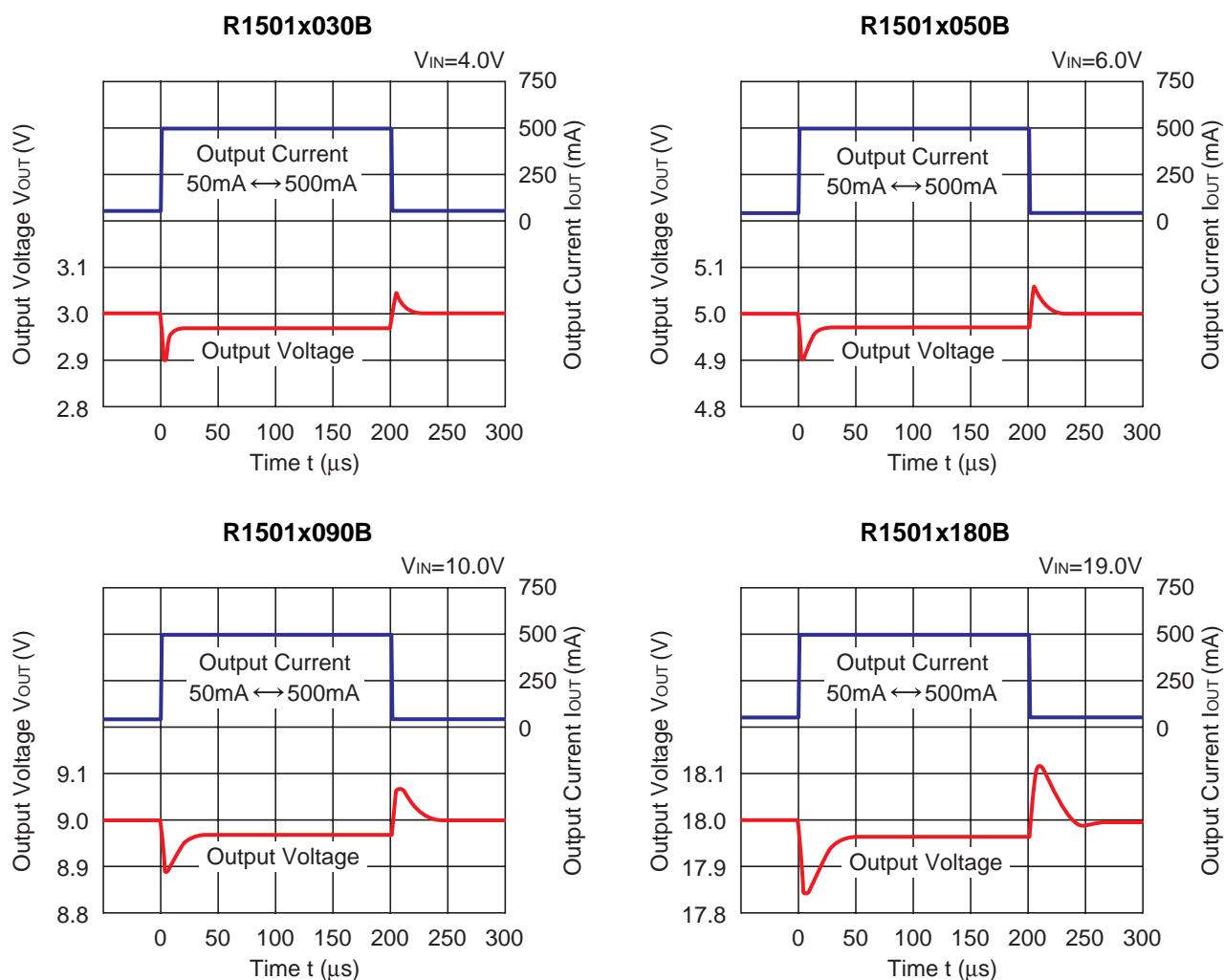

12) Turn On Speed with CE pin (C_1 =Ceramic $0.47\mu\text{F}$, C_2 =Ceramic $10\mu\text{F}$, $t_r=t_f=0.5\mu\text{s}$)

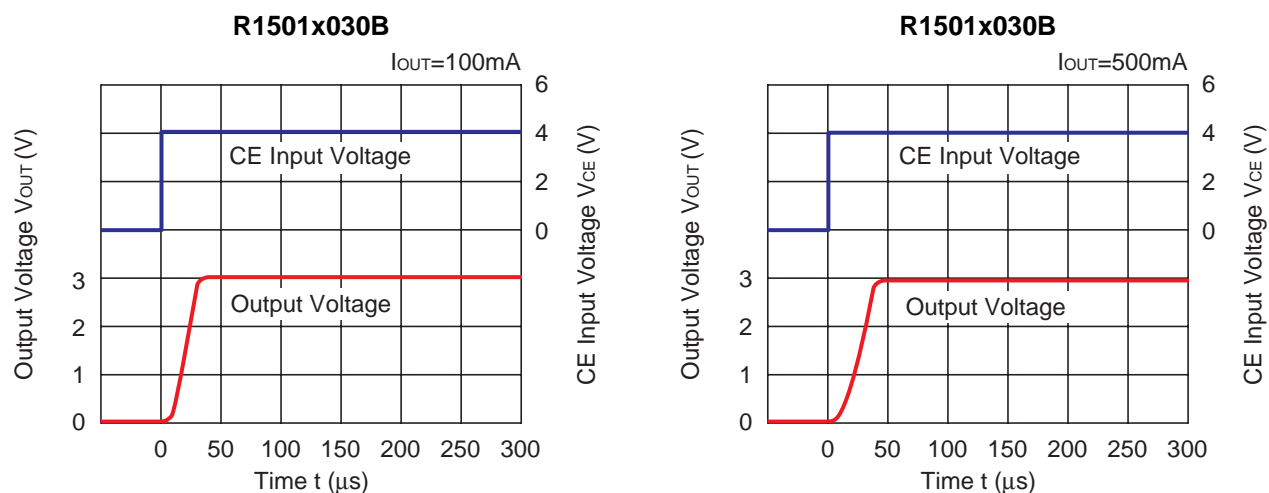

R1501x050B

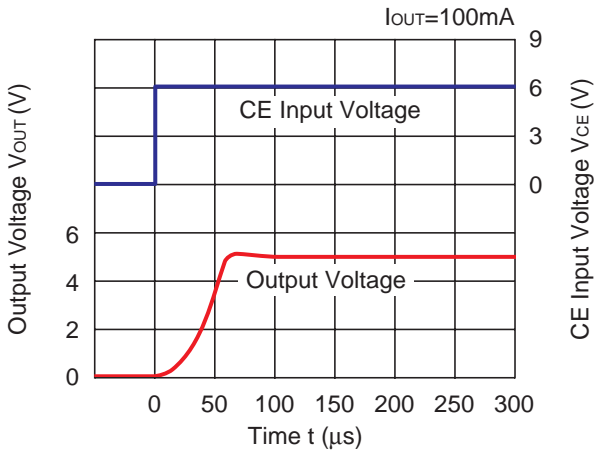

R1501x050B

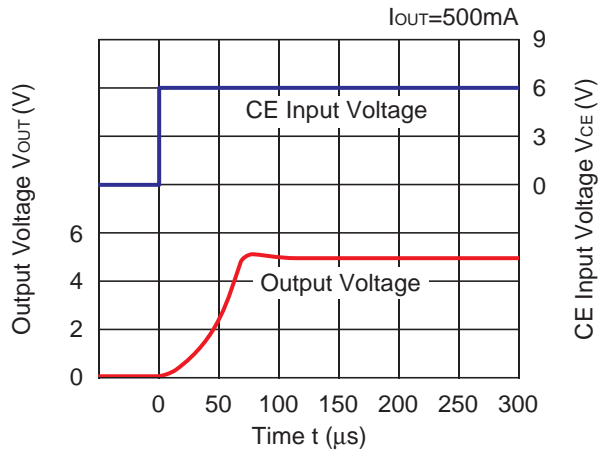

R1501x090B

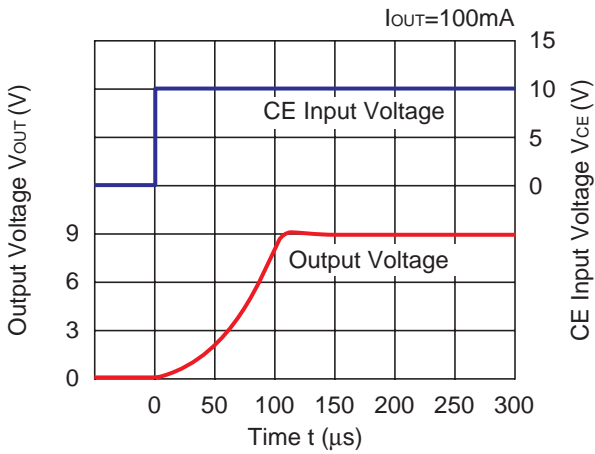

R1501x090B

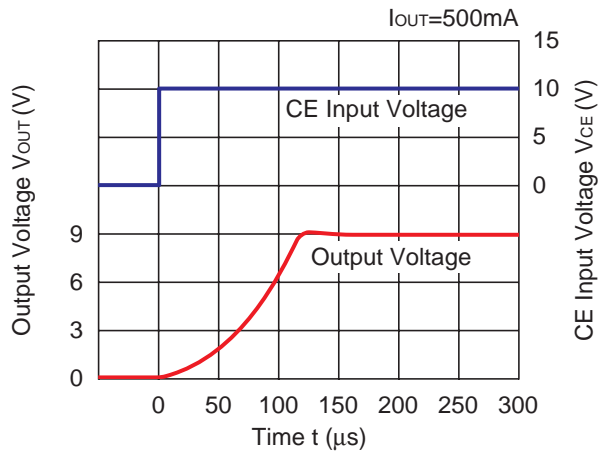

R1501x180B

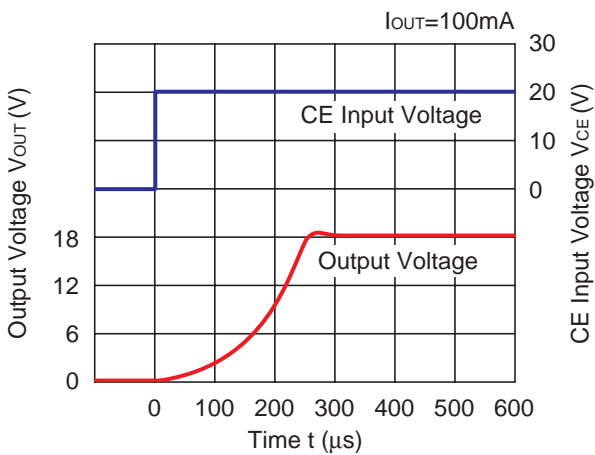

R1501x180B

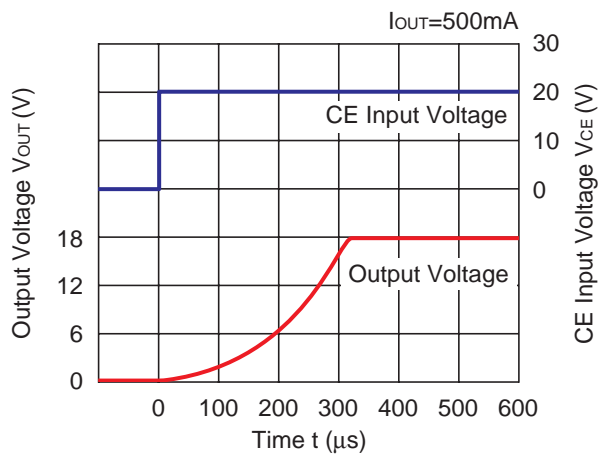

13) Turn Off Speed with CE (C1=Ceramic 0.47 μ F, C2=Ceramic 10 μ F, I_{OUT}=500mA, tr=tf=0.5 μ s)

R1501x030B

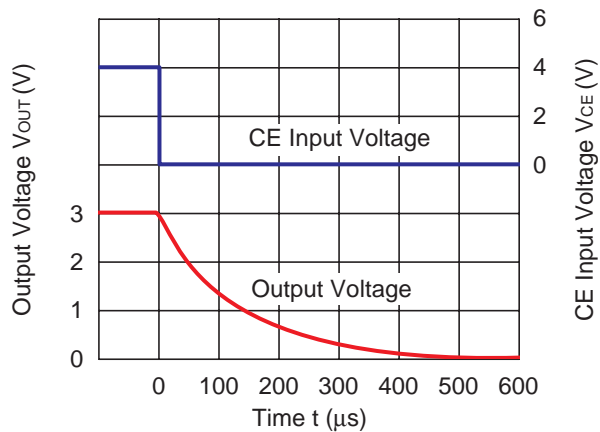

R1501x050B

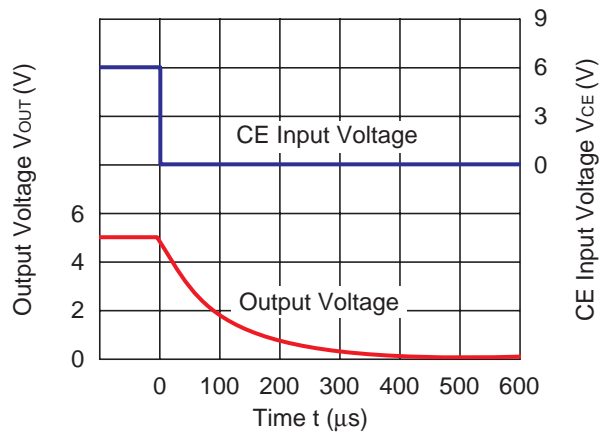

R1501x090B

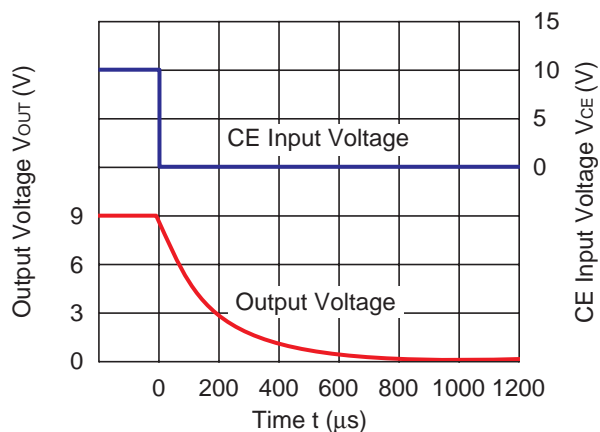

R1501x180B

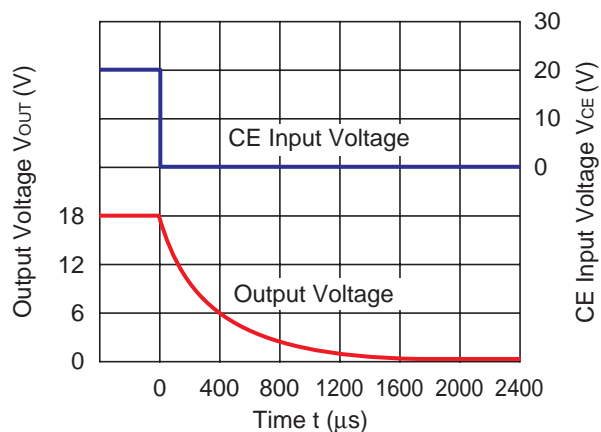

ESR vs. Output Current

When using these ICs, consider the following points:

The relations between I_{OUT} (Output Current) and ESR of an output capacitor are shown below.

The conditions when the white noise level is under the specified certain level are marked as the hatched area in the graph.

Measurement conditions

Input Voltage : $V_{OUT} + 1V$ to 24V

Frequency Band : 10Hz to 1MHz

Temperature : $-40^{\circ}C$ to $105^{\circ}C$

Capacitor : C1=Ceramic 0.47 μ F
C2=Ceramic 10 μ F

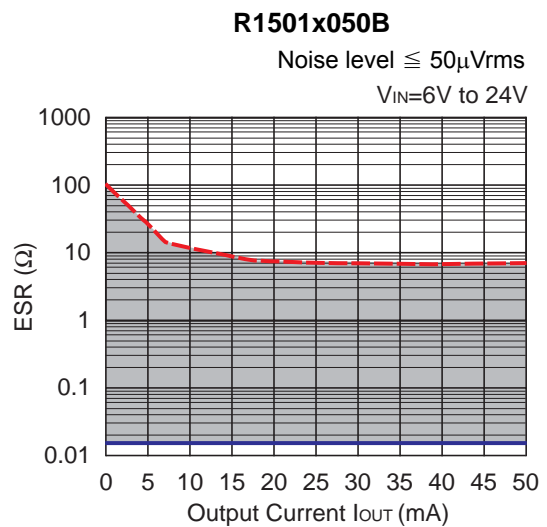
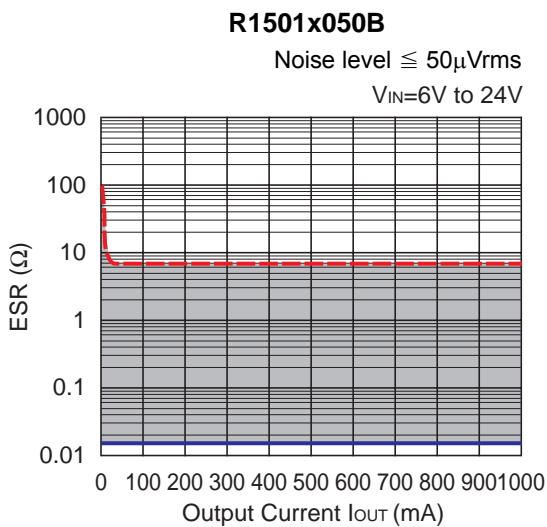
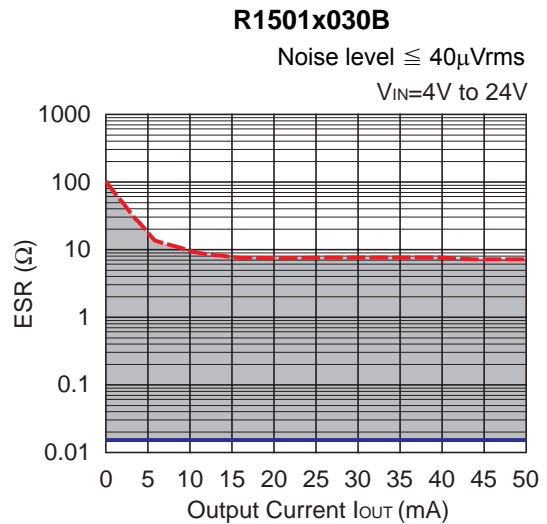
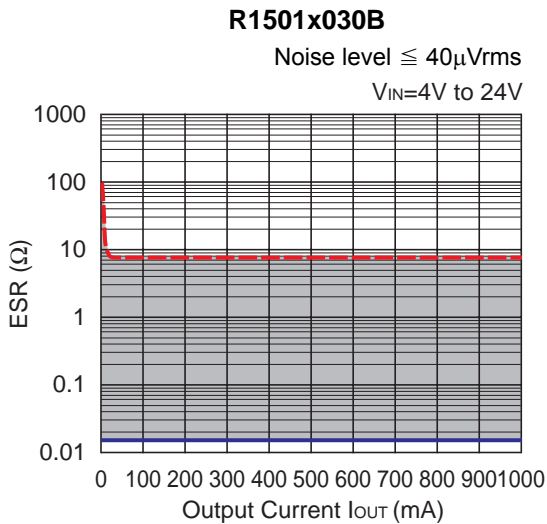

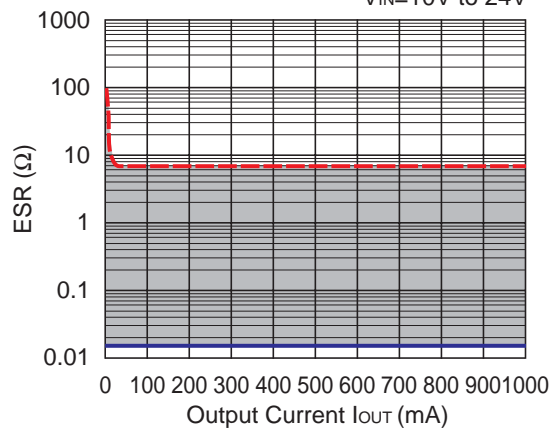
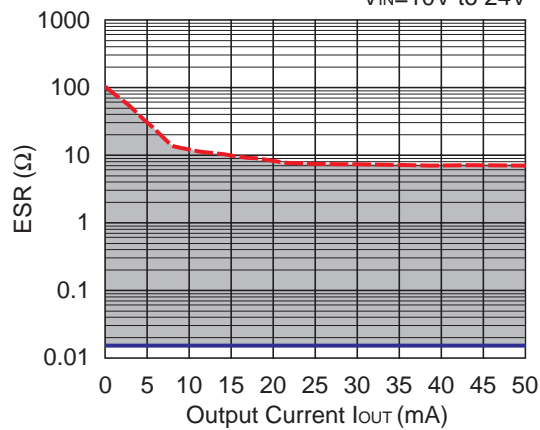
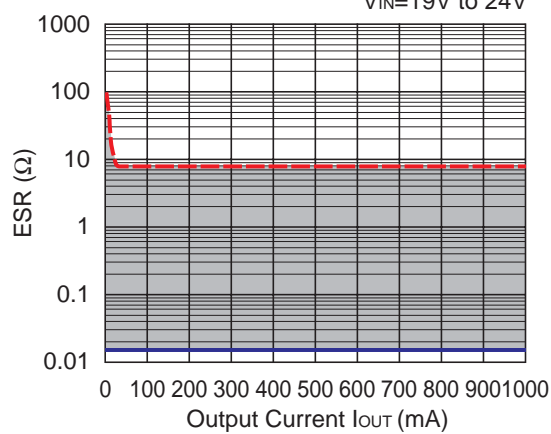
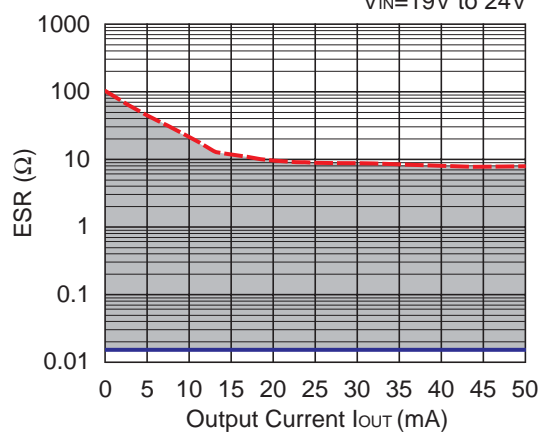
R1501x090BNoise level $\leq 120\mu\text{Vrms}$ $V_{\text{IN}}=10\text{V to }24\text{V}$ **R1501x090B**Noise level $\leq 120\mu\text{Vrms}$ $V_{\text{IN}}=10\text{V to }24\text{V}$ **R1501x180B**Noise level $\leq 220\mu\text{Vrms}$ $V_{\text{IN}}=19\text{V to }24\text{V}$ **R1501x180B**Noise level $\leq 220\mu\text{Vrms}$ $V_{\text{IN}}=19\text{V to }24\text{V}$ 

• HSOP-6J

Unit: mm

PACKAGE DIMENSIONS

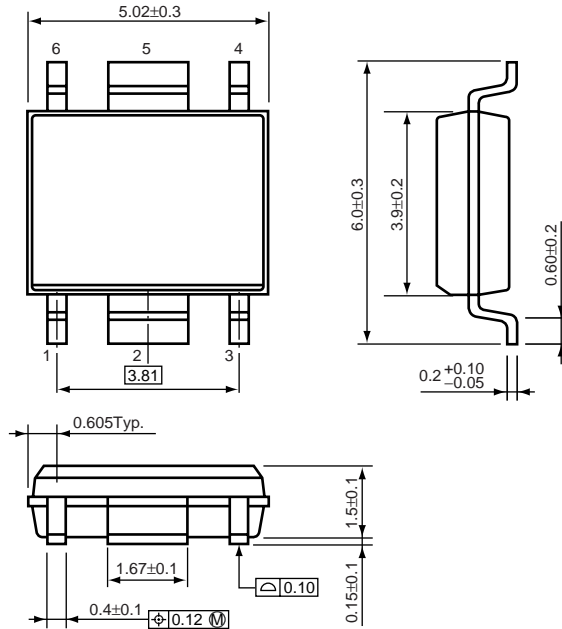

TAPING SPECIFICATION

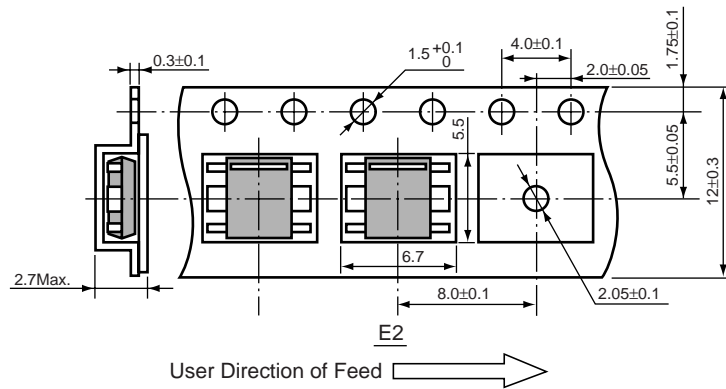

TAPING REEL DIMENSIONS REUSE REEL (EIAJ-RRM-12Bc)

(1reel=1000pcs)

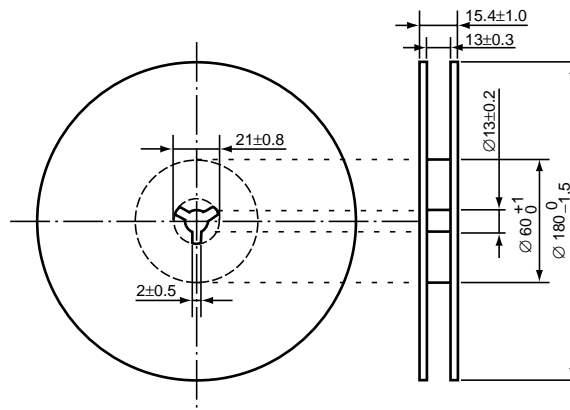

POWER DISSIPATION (HSOP-6J)

This specification is at mounted on board. Power Dissipation (P_D) depends on conditions of mounting on board. This specification is based on the measurement at the condition below:

Measurement Conditions

	High Wattage Land Pattern	Standard Land Pattern
Environment	Mounting on Board (Wind velocity=0m/s)	Mounting on Board (Wind velocity=0m/s)
Board Material	Glass cloth epoxy plactic (Double sided)	Glass cloth epoxy plactic (Double sided)
Board Dimensions	50mm × 50mm × 1.6mm	50mm × 50mm × 1.6mm
Copper Ratio	90%	50%
Through-hole	φ0.5mm × 44pcs	φ0.5mm × 44pcs

Measurement Result

($T_{opt}=25^{\circ}C, T_{jmax}=125^{\circ}C$)

	High Wattage Land Pattern	Standard Land Pattern	Free Air
Power Dissipation	2000mW	1700mW	540mW
Thermal Resistance	50°C/W	59°C/W	185°C/W

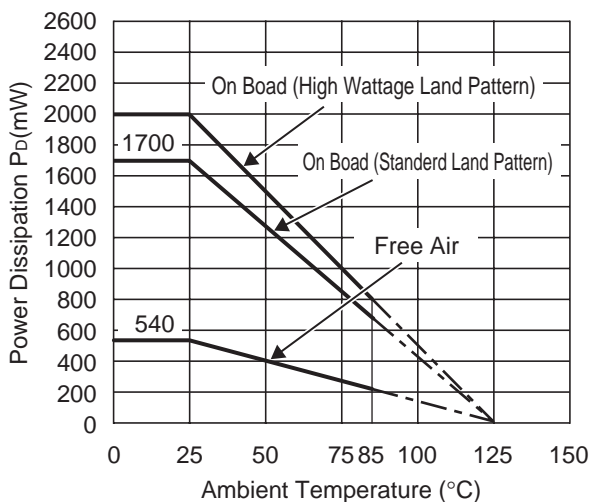

Power Dissipation

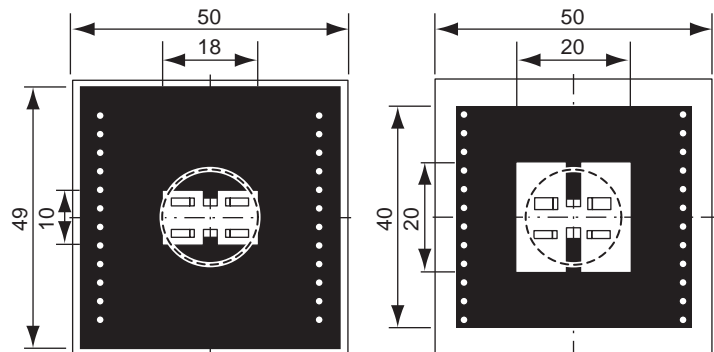

High Wattage

Standard

Measurement Board Pattern

○ IC Mount Area Unit : mm

RECOMMENDED LAND PATTERN (HSOP-6J)

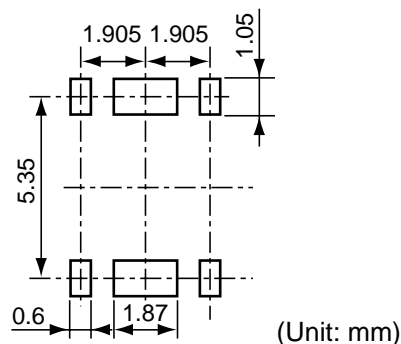

POWER DISSIPATION (TO-252-5-P2)

This specification is at mounted on board. Power Dissipation (P_D) depends on conditions of mounting on board. This specification is based on the measurement at the condition below:

Measurement Conditions

	Standard Land Pattern
Environment	Mounting on Board (Wind velocity=0m/s)
Board Material	Glass cloth epoxy plastic (Double sided)
Board Dimensions	50mm × 50mm × 1.6mm
Copper Ratio	Top side : Approx. 50% , Back side : Approx. 50%
Through-hole	φ0.5mm × 24pcs

Measurement Result (T_{opt}=25°C, T_{jmax}=125°C)

	Standard Land Pattern
Power Dissipation	1900mW
Thermal Resistance	$\theta_{ja}=(125-25^\circ\text{C})/1.9\text{W}=53^\circ\text{C/W}$

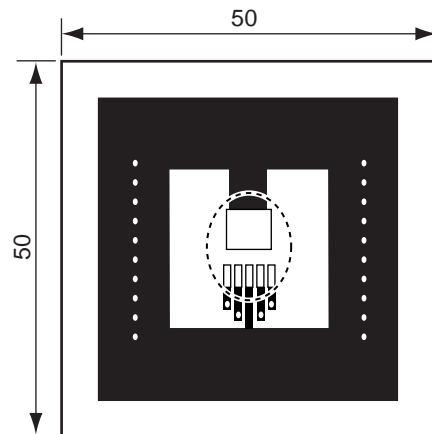
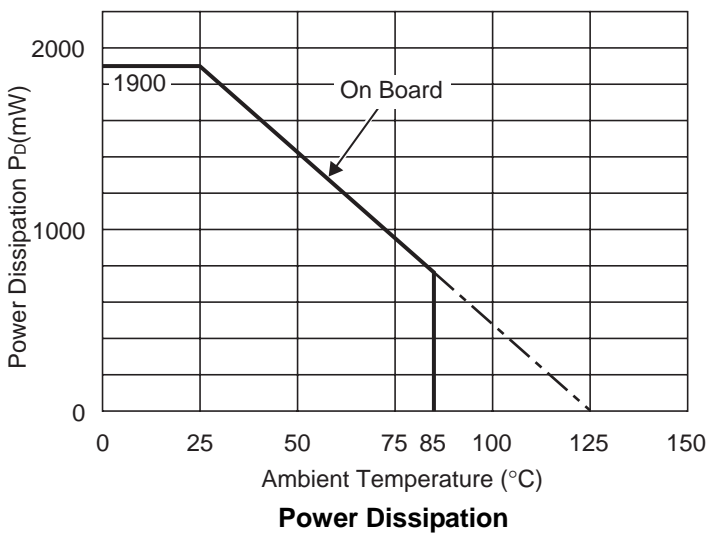

Measurement Board Pattern
 ○ IC Mount Area (Unit: mm)

RECOMMENDED LAND PATTERN

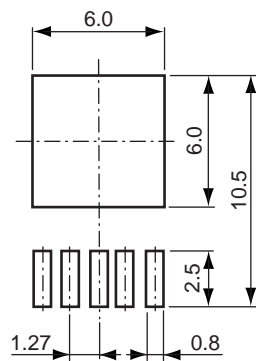

(Unit: mm)

R1501S SERIES MARK SPECIFICATION

● HSOP-6J

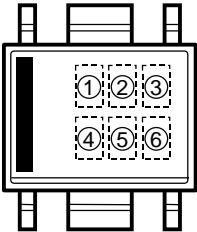

- ① : H (fixed)
- ②, ③, ④ : Setting Voltage } (Refer to Part Number vs. Product Code)
- ⑤, ⑥ : Lot Number

● Part Number vs. Product Code

Part Number	Product Code			
	①	②	③	④
R1501S030B	H	0	3	0
R1501S031B	H	0	3	1
R1501S032B	H	0	3	2
R1501S033B	H	0	3	3
R1501S034B	H	0	3	4
R1501S035B	H	0	3	5
R1501S036B	H	0	3	6
R1501S037B	H	0	3	7
R1501S038B	H	0	3	8
R1501S039B	H	0	3	9
R1501S040B	H	0	4	0
R1501S041B	H	0	4	1
R1501S042B	H	0	4	2
R1501S043B	H	0	4	3
R1501S044B	H	0	4	4
R1501S045B	H	0	4	5
R1501S046B	H	0	4	6
R1501S047B	H	0	4	7
R1501S048B	H	0	4	8
R1501S049B	H	0	4	9
R1501S050B	H	0	5	0
R1501S051B	H	0	5	1
R1501S052B	H	0	5	2
R1501S053B	H	0	5	3
R1501S054B	H	0	5	4
R1501S055B	H	0	5	5
R1501S056B	H	0	5	6
R1501S057B	H	0	5	7
R1501S058B	H	0	5	8
R1501S059B	H	0	5	9

Part Number	Product Code			
	①	②	③	④
R1501S060B	H	0	6	0
R1501S061B	H	0	6	1
R1501S062B	H	0	6	2
R1501S063B	H	0	6	3
R1501S064B	H	0	6	4
R1501S065B	H	0	6	5
R1501S066B	H	0	6	6
R1501S067B	H	0	6	7
R1501S068B	H	0	6	8
R1501S069B	H	0	6	9
R1501S070B	H	0	7	0
R1501S071B	H	0	7	1
R1501S072B	H	0	7	2
R1501S073B	H	0	7	3
R1501S074B	H	0	7	4
R1501S075B	H	0	7	5
R1501S076B	H	0	7	6
R1501S077B	H	0	7	7
R1501S078B	H	0	7	8
R1501S079B	H	0	7	9
R1501S080B	H	0	8	0
R1501S081B	H	0	8	1
R1501S082B	H	0	8	2
R1501S083B	H	0	8	3
R1501S084B	H	0	8	4
R1501S085B	H	0	8	5
R1501S086B	H	0	8	6
R1501S087B	H	0	8	7
R1501S088B	H	0	8	8
R1501S089B	H	0	8	9

Part Number	Product Code			
	①	②	③	④
R1501S090B	H	0	9	0
R1501S091B	H	0	9	1
R1501S092B	H	0	9	2
R1501S093B	H	0	9	3
R1501S094B	H	0	9	4
R1501S095B	H	0	9	5
R1501S096B	H	0	9	6
R1501S097B	H	0	9	7
R1501S098B	H	0	9	8
R1501S099B	H	0	9	9
R1501S100B	H	1	0	0
R1501S101B	H	1	0	1
R1501S102B	H	1	0	2
R1501S103B	H	1	0	3
R1501S104B	H	1	0	4
R1501S105B	H	1	0	5
R1501S106B	H	1	0	6
R1501S107B	H	1	0	7
R1501S108B	H	1	0	8
R1501S109B	H	1	0	9
R1501S110B	H	1	1	0
R1501S111B	H	1	1	1
R1501S112B	H	1	1	2
R1501S113B	H	1	1	3
R1501S114B	H	1	1	4
R1501S115B	H	1	1	5
R1501S116B	H	1	1	6
R1501S117B	H	1	1	7
R1501S118B	H	1	1	8
R1501S119B	H	1	1	9

Part Number	Product Code			
	①	②	③	④
R1501S120B	H	1	2	0
R1501S125B	H	1	2	5
R1501S130B	H	1	3	0
R1501S135B	H	1	3	5
R1501S140B	H	1	4	0
R1501S145B	H	1	4	5
R1501S150B	H	1	5	0
R1501S155B	H	1	5	5
R1501S160B	H	1	6	0
R1501S165B	H	1	6	5
R1501S170B	H	1	7	0
R1501S175B	H	1	7	5
R1501S180B	H	1	8	0

R1501J SERIES MARK SPECIFICATION

• TO-252-5-P2

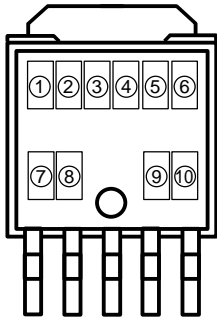

- ①, ② : A1 (fixed)
 - ③ : J (Package)
 - ④, ⑤, ⑥ : Setting Voltage
 - ⑦ : Type (B)
 - ⑧ : Blank
 - ⑨, ⑩ : Lot Number
- (Refer to Part Number vs. Product Code)

• Part Number vs. Product Code

Part Number	Product Code							
	①	②	③	④	⑤	⑥	⑦	⑧
R1501J030B	A	1	J	0	3	0	B	
R1501J031B	A	1	J	0	3	1	B	
R1501J032B	A	1	J	0	3	2	B	
R1501J033B	A	1	J	0	3	3	B	
R1501J034B	A	1	J	0	3	4	B	
R1501J035B	A	1	J	0	3	5	B	
R1501J036B	A	1	J	0	3	6	B	
R1501J037B	A	1	J	0	3	7	B	
R1501J038B	A	1	J	0	3	8	B	
R1501J039B	A	1	J	0	3	9	B	
R1501J040B	A	1	J	0	4	0	B	
R1501J041B	A	1	J	0	4	1	B	
R1501J042B	A	1	J	0	4	2	B	
R1501J043B	A	1	J	0	4	3	B	
R1501J044B	A	1	J	0	4	4	B	
R1501J045B	A	1	J	0	4	5	B	
R1501J046B	A	1	J	0	4	6	B	
R1501J047B	A	1	J	0	4	7	B	
R1501J048B	A	1	J	0	4	8	B	
R1501J049B	A	1	J	0	4	9	B	
R1501J050B	A	1	J	0	5	0	B	
R1501J051B	A	1	J	0	5	1	B	
R1501J052B	A	1	J	0	5	2	B	
R1501J053B	A	1	J	0	5	3	B	
R1501J054B	A	1	J	0	5	4	B	
R1501J055B	A	1	J	0	5	5	B	
R1501J056B	A	1	J	0	5	6	B	
R1501J057B	A	1	J	0	5	7	B	
R1501J058B	A	1	J	0	5	8	B	
R1501J059B	A	1	J	0	5	9	B	
R1501J060B	A	1	J	0	6	0	B	
R1501J061B	A	1	J	0	6	1	B	
R1501J062B	A	1	J	0	6	2	B	
R1501J063B	A	1	J	0	6	3	B	
R1501J064B	A	1	J	0	6	4	B	
R1501J065B	A	1	J	0	6	5	B	
R1501J066B	A	1	J	0	6	6	B	
R1501J067B	A	1	J	0	6	7	B	
R1501J068B	A	1	J	0	6	8	B	
R1501J069B	A	1	J	0	6	9	B	

Part Number	Product Code							
	①	②	③	④	⑤	⑥	⑦	⑧
R1501J070B	A	1	J	0	7	0	B	
R1501J071B	A	1	J	0	7	1	B	
R1501J072B	A	1	J	0	7	2	B	
R1501J073B	A	1	J	0	7	3	B	
R1501J074B	A	1	J	0	7	4	B	
R1501J075B	A	1	J	0	7	5	B	
R1501J076B	A	1	J	0	7	6	B	
R1501J077B	A	1	J	0	7	7	B	
R1501J078B	A	1	J	0	7	8	B	
R1501J079B	A	1	J	0	7	9	B	
R1501J080B	A	1	J	0	8	0	B	
R1501J081B	A	1	J	0	8	1	B	
R1501J082B	A	1	J	0	8	2	B	
R1501J083B	A	1	J	0	8	3	B	
R1501J084B	A	1	J	0	8	4	B	
R1501J085B	A	1	J	0	8	5	B	
R1501J086B	A	1	J	0	8	6	B	
R1501J087B	A	1	J	0	8	7	B	
R1501J088B	A	1	J	0	8	8	B	
R1501J089B	A	1	J	0	8	9	B	
R1501J090B	A	1	J	0	9	0	B	
R1501J091B	A	1	J	0	9	1	B	
R1501J092B	A	1	J	0	9	2	B	
R1501J093B	A	1	J	0	9	3	B	
R1501J094B	A	1	J	0	9	4	B	
R1501J095B	A	1	J	0	9	5	B	
R1501J096B	A	1	J	0	9	6	B	
R1501J097B	A	1	J	0	9	7	B	
R1501J098B	A	1	J	0	9	8	B	
R1501J099B	A	1	J	0	9	9	B	
R1501J100B	A	1	J	1	0	0	B	
R1501J101B	A	1	J	1	0	1	B	
R1501J102B	A	1	J	1	0	2	B	
R1501J103B	A	1	J	1	0	3	B	
R1501J104B	A	1	J	1	0	4	B	
R1501J105B	A	1	J	1	0	5	B	
R1501J106B	A	1	J	1	0	6	B	
R1501J107B	A	1	J	1	0	7	B	
R1501J108B	A	1	J	1	0	8	B	
R1501J109B	A	1	J	1	0	9	B	

Part Number	Product Code							
	①	②	③	④	⑤	⑥	⑦	⑧
R1501J110B	A	1	J	1	1	0	B	
R1501J111B	A	1	J	1	1	1	B	
R1501J112B	A	1	J	1	1	2	B	
R1501J113B	A	1	J	1	1	3	B	
R1501J114B	A	1	J	1	1	4	B	
R1501J115B	A	1	J	1	1	5	B	
R1501J116B	A	1	J	1	1	6	B	
R1501J117B	A	1	J	1	1	7	B	
R1501J118B	A	1	J	1	1	8	B	
R1501J119B	A	1	J	1	1	9	B	
R1501J120B	A	1	J	1	2	0	B	
R1501J125B	A	1	J	1	2	5	B	
R1501J130B	A	1	J	1	3	0	B	
R1501J135B	A	1	J	1	3	5	B	
R1501J140B	A	1	J	1	4	0	B	
R1501J145B	A	1	J	1	4	5	B	
R1501J150B	A	1	J	1	5	0	B	
R1501J155B	A	1	J	1	5	5	B	
R1501J160B	A	1	J	1	6	0	B	
R1501J165B	A	1	J	1	6	5	B	
R1501J170B	A	1	J	1	7	0	B	
R1501J175B	A	1	J	1	7	5	B	
R1501J180B	A	1	J	1	8	0	B	