



Helping Customers Innovate, Improve & Grow



Features

- Excellent Temperature Stability
- Stratum 3 compliant
- CMOS and clipped sinewave output
- Good Phase noise behaviour
- EFC option
- Small Size, low profile
- 100% RoHS Compliant
- Frequency range ¹ of 6.4 - 35 MHz
- Standard Frequencies ¹: 10, 12.8, 19.2, 19.44, 20, 20.48, 26MHz
- up to 52MHz on request for reduced stabilities

Applications

- Wireline Stratum 3 applications
- Femto cell
- Test & Measurement
- Wireless Communications

Previous Vectron Model Numbers - C2260, TX-700

Performance Specifications

Frequency Stabilities ^{1,5}						
Parameter	Min	Typical	Max	Units	Condition	Options ⁵
vs. operating temperature range (referenced to +25°C)	-0.14		+0.14	ppm	0 to +50°C	
	-0.28		+0.28	ppm	-20 to +70°C	
	-0.28		+0.28	ppm	-40 to +85°C	
Initial tolerance	-1.0		+1.0	ppm	at time of shipment, nominal EFC V _s ±5% static Load ±5% static Note:*Stratum 3 per GR-1244-CORE: <±4.6ppm for all causes and 20 years aging, holdover: <±0.37ppm over 24 hours	
vs. supply voltage change	-0.2		+0.2	ppm		
vs. load change	-0.1		+0.1	ppm		
vs. aging / 20 Years	-2.5		+2.5	ppm		
Overall tolerance	-4.6		+4.6	ppm		

Performance Specifications

Supply Voltage (Vs)						
Parameter	Min	Typical	Max	Units	Condition ²	
Supply voltage (standard)	3.135	3.3	3.465	VDC		
Current consumption			6	mA	steady state @ +25°C	
RF Output (Clipped Sinewave)						
Load R	9	10	11	kΩ		
C	9	10	11	pF		
Output Power	0.7			V _{pp}	@ 10kΩ 10pF	
RF Output (HCMOS)						
Load	13.5	15	16.5	pF		
Signal Level (Vol)			0.3	VDC	with Vs=3.3V and 15pF Load	
Signal Level (Voh)	3.0			VDC	with Vs=3.3V and 15pF Load	
Rise and Fall time			5	ns		
Duty Cycle	40	50	60	%	@ (Voh-Vol)/2	
Frequency Tuning (EFC)						
Tuning Range	Fixed TCXO; No adjust				Opti- on ⁵	
Tuning Range	±5.0	±14.0	±20.0	ppm		
Linearity	10%					
Tuning Slope	Positive					
Control Voltage Range	0.3	1.65	3.0	VDC	with Vs=3.3V	
Freq. control input impedance	10			kΩ		
Additional Parameters						
Phase Noise ³		-95 -120 -143 -155 -157		dBc/Hz dBc/Hz dBc/Hz dBc/Hz dBc/Hz	10 Hz 100 Hz 1k Hz 10 kHz 100 kHz	@ 10MHz
Weight	1.0 g					
Processing & Packing	Handling & Processing Note					
Absolute Maximum Ratings						
Supply voltage (Vs)			6.0	V		
Control Voltage	0		Vs	V		
Operable Temperature Range	-40		+85	°C		
Storage Temperature Range	-55		+125	°C		

Standard Shipping Method

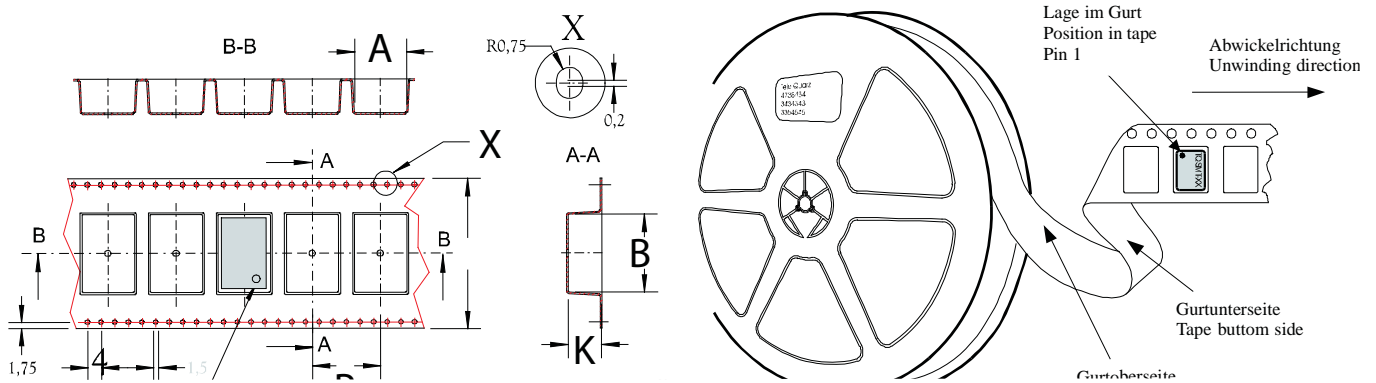

Enclosure Type	Tape Width W (mm)	Quantity per meter	Quantity per reel	Dimension P
G290/G298	12	150.	750.	8

Standard Shipping Method

Package Codes: 703

Type	Height "H"
G298	1.8mm

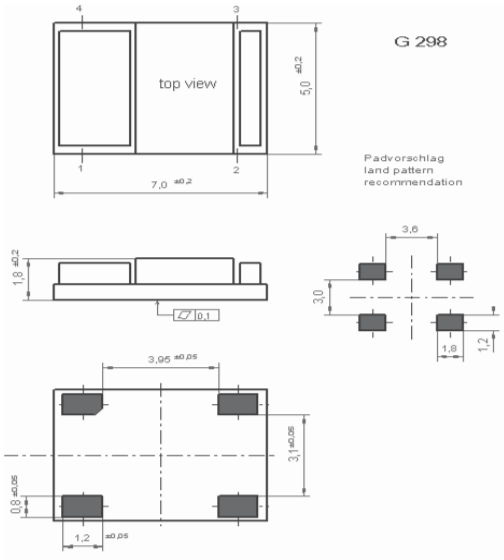

Package Codes: 704

Type	Height "H"
G290	1.8mm

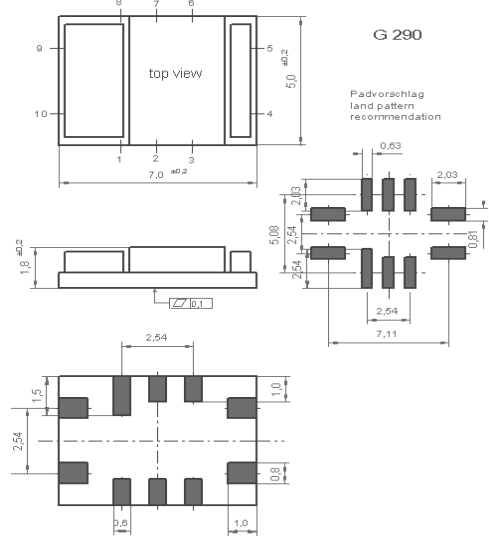

Pin Connections: TX-703

1	Voltage Control (Vc) / Enable / N.C
2	Ground (Case)
3	RF Output
4	Supply Voltage Input (Vs)

Pin Connections: TX-704

1	I.C.
2	Ground (Case)
3	I.C.
4	GND
5	RF Output
6	N.C.
7	N.C.
8	Enable/N.C.
9	Supply Voltage Input (Vs)
10	Voltage Control (Vc) / N.C.

Enable true table (optional): TX-703

Pin 1	Pin 3
High	Data
Open	Data
Low	High Tristate

Enable true table (optional): TX-704

Pin 8	Pin 5
High	Data
Open	Data
Low	High Tristate

Marking

TX-70X
Frequency
● AYYWW

Typical Measurement Data

Phase Noise ³

TX703 @ 10 MHz

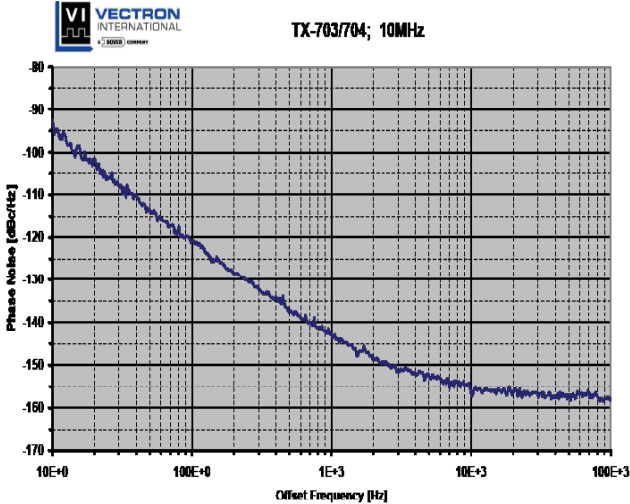

MTIE according-1244-CORE:

TX-703 @ 10 MHz

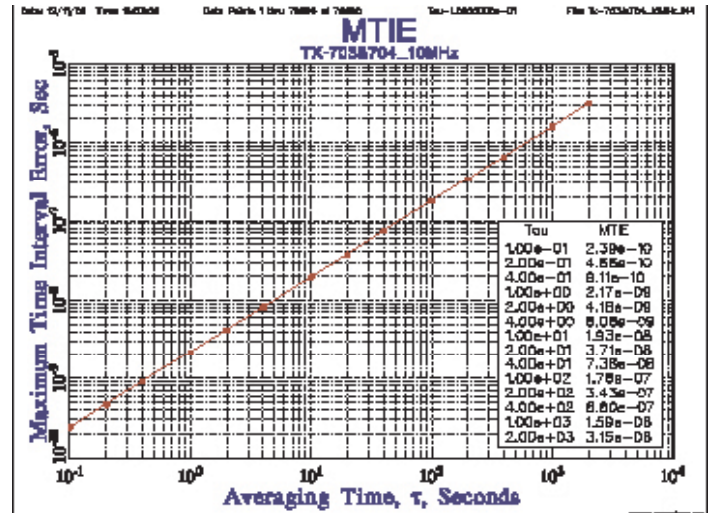

Recommended Reflow Profile

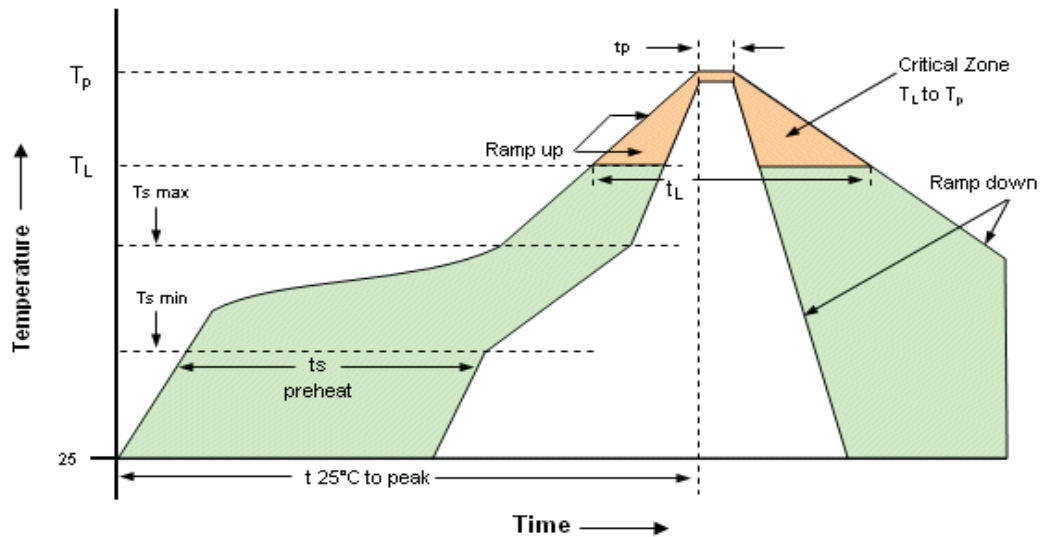

Profile Feature	Pb-Free Assembly/ Sn-Pb Assembly	Profile Feature	Pb-Free Assembly/ Sn-Pb Assembly
Average ramp-up rate (T_L to T_p)	3°C/second max.	Time 25°C to Peak Temperature	8 minutes max.
Preheat -Temperature Min T_{Smin} -Temperature Min T_{Smax} -Time (min to max) t_s	150°C 200°C 60-180 seconds	Time maintained above -Temperature (T_L) -Time (t_L)	217°C 60-150 seconds
T_{Smax} to T_L -Ramp-up Rate	3°C/second max		
Time maintained above -Temperature (T_L) -Time (t_L)	217°C 60-150 seconds	Time within 5°C of actual Peak Temperature (t_p)	20-40 seconds
Peak Temperature (T_p)	max 260°C	Ramp-down Rate	6°C/ second max

Note: All temperatures refer to topside of the package, measured on the package body surface.

TX-70X 0 - E A J - 287 0 - 10M0000000

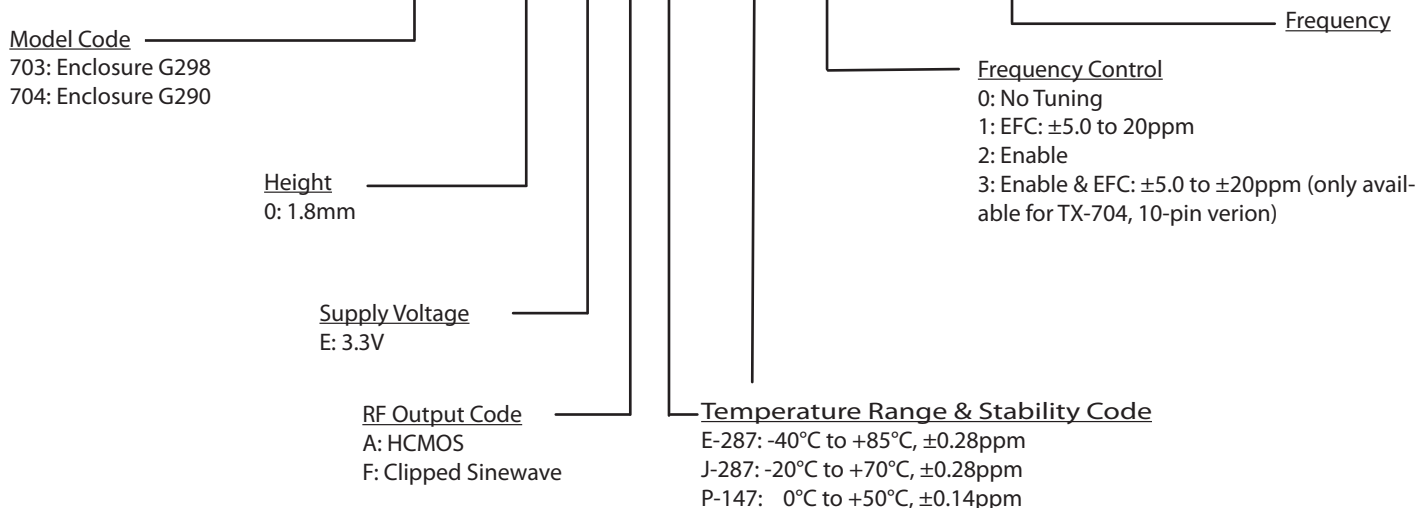

Notes:

1. Contact factory for improved stabilities or additional product options. Not all options and codes are available at all frequencies.
2. Unless other stated all values are valid after warm-up time and refer to typical conditions for supply voltage, frequency control voltage, load, temperature (25°C).
3. Phase noise degrades with increasing output frequency.
4. Subject to technical modification.
5. Contact factory for availability.

For Additional Information, Please Contact

USA:

Vectron International
267 Lowell Road
Hudson, NH 03051
Tel: 1.888.328.7661
Fax: 1.888.329.8328

Europe:

Vectron International
Landstrasse, D-74924
Neckarbischofsheim, Germany
Tel: +49 (0) 7268.801.100
Fax: +49 (0) 7268.801.281

Asia:

Vectron International
1F-2F, No 8 Workshop, No 308 Fenju Road
WaiGaoQiao Free Trade Zone
Pudong, Shanghai, China 200131
Tel: 86.21.5048.0777
Fax: 86.21.5048.1881

Disclaimer

Vectron International reserves the right to make changes to the product(s) and or information contained herein without notice. No liability is assumed as a result of their use or application. No rights under any patent accompany the sale of any such product(s) or information.

Rev: 8/2008