

液晶之友 电话: 020-33819057
 Http://www.lcdfriends.com

PRODUCT SPECIFICATION

MONOCHROME LCD MODULE

PART NUMBER : FDG128032B

DESCRIPTION : 32x128Graphic

REVISION : Rev A

	Approval for Specification only		Approval for Sample Only
	Approval for Pre-production	x	Approval for Mass Production

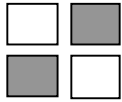

FDG128032B (128 DOTS X 32 DOTS)

FEATURES

- ◆ BUILT-IN CONTROLLER (HT1670 OR EQUIVALENT)
- ◆ +5 V POWER SUPPLY
- ◆ 1/32 DUTY CYCLE
- ◆ 8-BIT PARALLEL INTERFACE
- ◆ 4.2 V LED FORWARD VOLTAGE

MECHANICAL DATA

ITEM	DIMENSIONS	UNIT
Module Size (W x H x T)	73.0 x 37.0 x 10.8	mm
Viewing Area (W x H)	63.0 x 17.7	mm
Active Area (W x H)	58.84 x 14.68	mm
Dot Size (W x H)	0.42 x 0.42	mm
Dot Pitch (W x H)	0.46 x 0.46	mm

INTERFACE PIN CONNECTIONS

NO.	SYMBOL	LEVEL	FUNCTION
1	V _{SS}	0V	Power Supply Ground
2	V _{DD}	5V	Power Supply Voltage
3	LIGHT	4.1V	LED Power Supply (+)
4	/CS	L	Chip Singal
5	/WR	L	Write Singal
6	/RD	L	Read Signal
7-10	DB0-DB3	H/L	Data Bus Line
11	/CLOCK	L	Time base or watchdog timer overflow flag
12	BZ+	-	2kHz Or 4 kHz Tone Frequency Output Pair .
13	BZ-	-	2kHz Or 4 kHz Tone Frequency Output Pair .

ABSOLUTE MAXIMUM RATINGS

ITEM	SYMBOL	MIN.	TYP.	MAX.	UNIT
Supply Voltage For Logic	V _{DD} -V _{SS}	0	-	7	V
Supply Voltage For LCD Drive	V _{DD} -V _o	0	-	12	V
Input Voltage	V _I	V _{SS}	-	V _{DD}	V

ELECTRICAL CHARACTERISTICS

ITEM	SYMBOL	CONDITION	MIN.	TYP.	MAX.	UNIT	
Supply Voltage For Logic	V _{DD} -V _{SS}	-	4.5	5	5.5	V	
Supply Voltage For LCD	V _{DD} -V _o	V _{DD} =5V Ta=25°C	4.4	4.8	5.2	V	
Supply Current	I _{DD}	V _{DD} =5V	-	3	4.5	mA	
Input Voltage	"HIGH" Level	V _{IH}	-	2.2	-	V _{DD}	V
	"LOW" Level	V _{IL}	-	-	-	0.6	V
Output Voltage	"HIGH" Level	V _{OH}	-	2.4	-	V	V
	"LOW" Level	V _{OL}	-	-	-	0.4	V

EXTERNAL DIMENSIONS

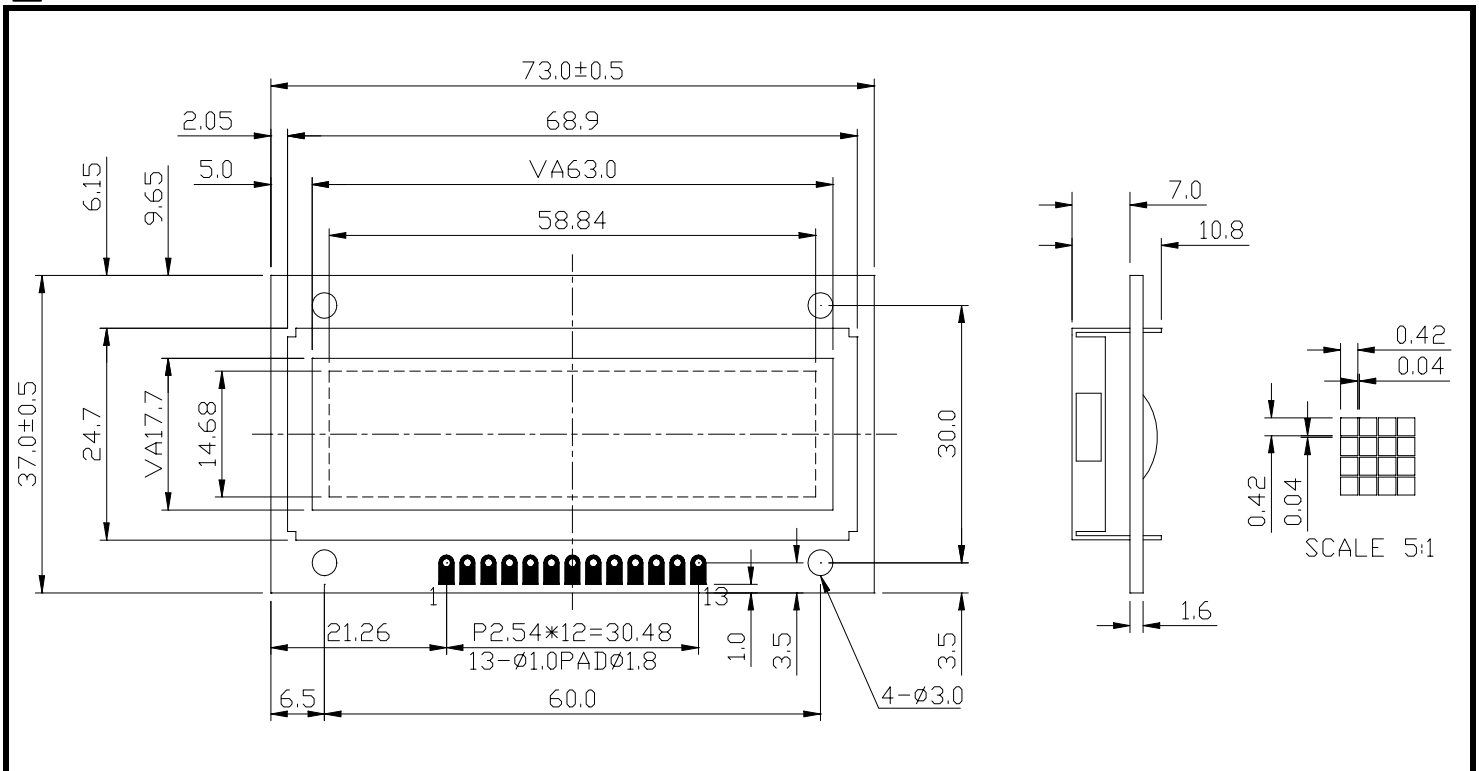

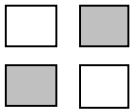

FDG128032B (8 CHARACTERS X 2 LINES)

TIMING CHARACTERISTICS

ITEM	SYMBOL	MIN.	TYP.	MAX.	UNIT.
4-Bit Interface Reset Pulse Width	/CS	-	250	-	ns
/WR Input Pulse Width	Write	1.67	-	-	us
/RD Input Pulse Width	Read	3.34	-	-	us
Rise/Fall Time Serial Data Clock Width	tr , tf	-	120	-	ns
Setup Time for DATA to WR , RD Clock Width	tsu	-	120	-	ns
Hold Time for DATA to WR , RD Clock Width	th	-	120	-	ns
Setup Time for CS to WR , RD Clock Width	tsu1	-	100	-	ns
Hold Time for CS to WR , RD Clock Width	th1	-	100	-	ns

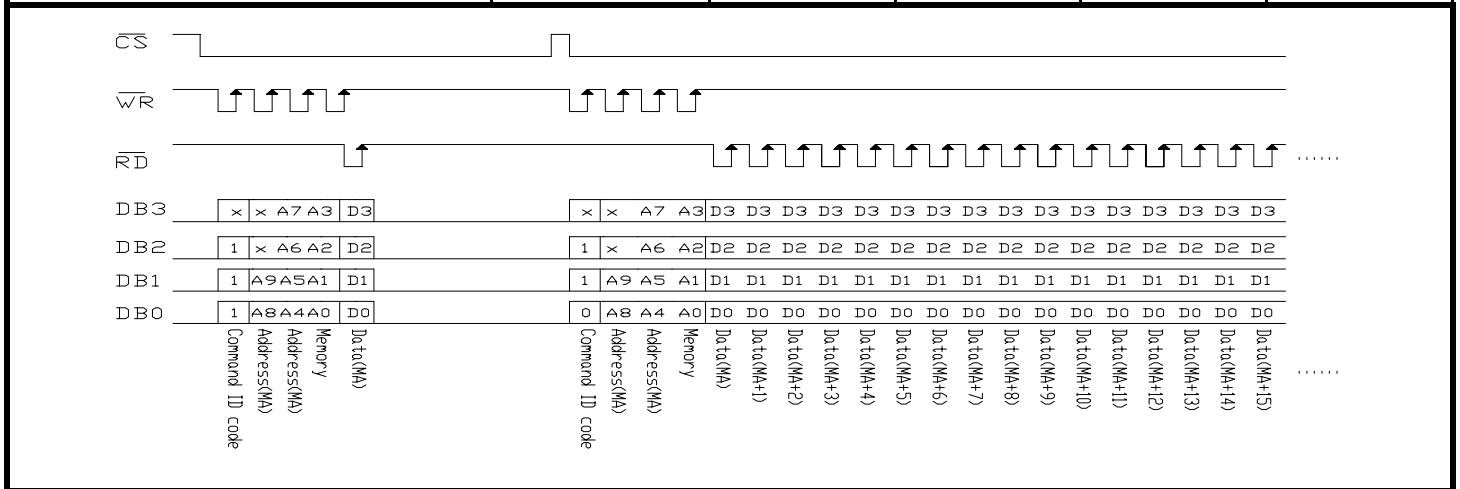

BLOCK DIAGRAM

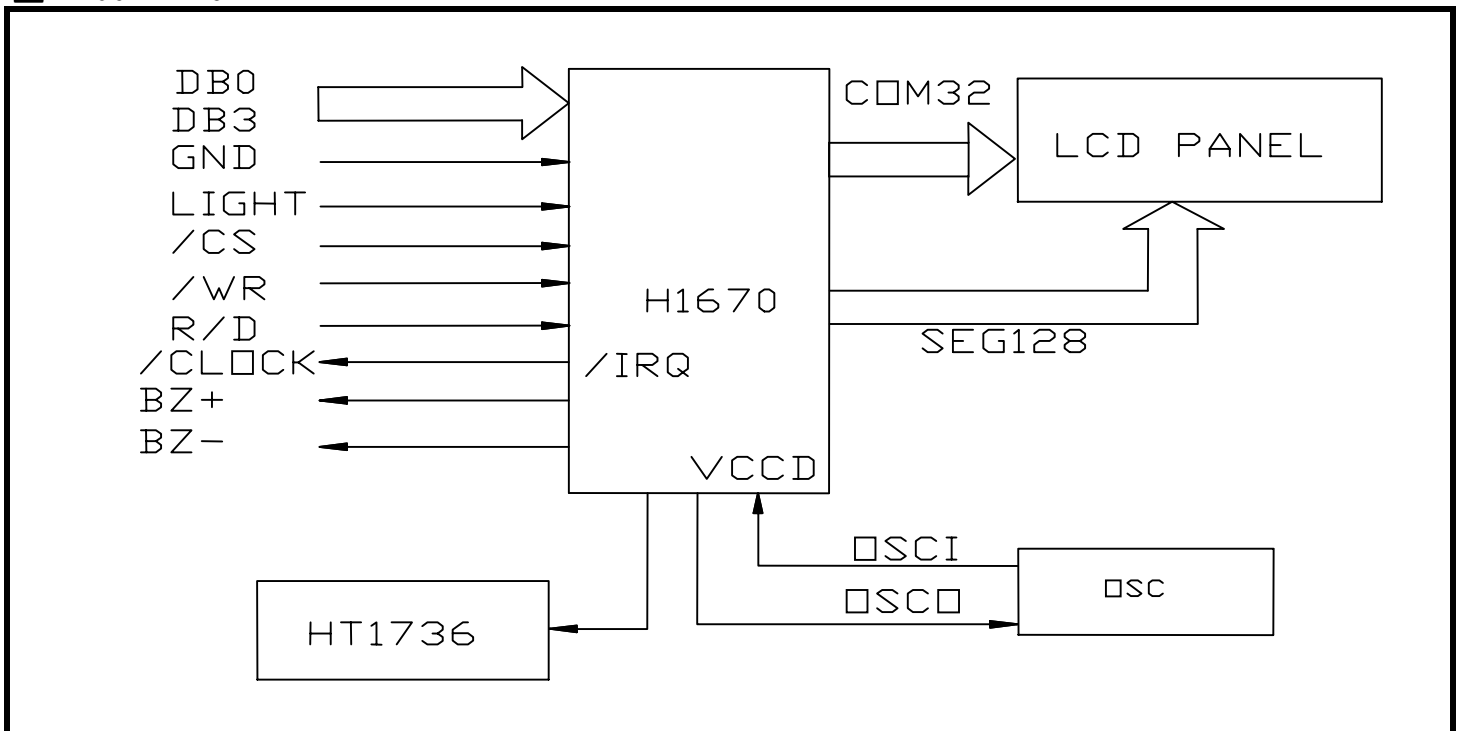

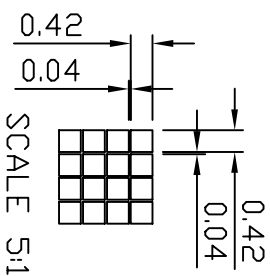
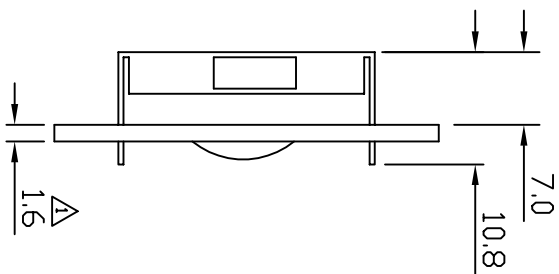
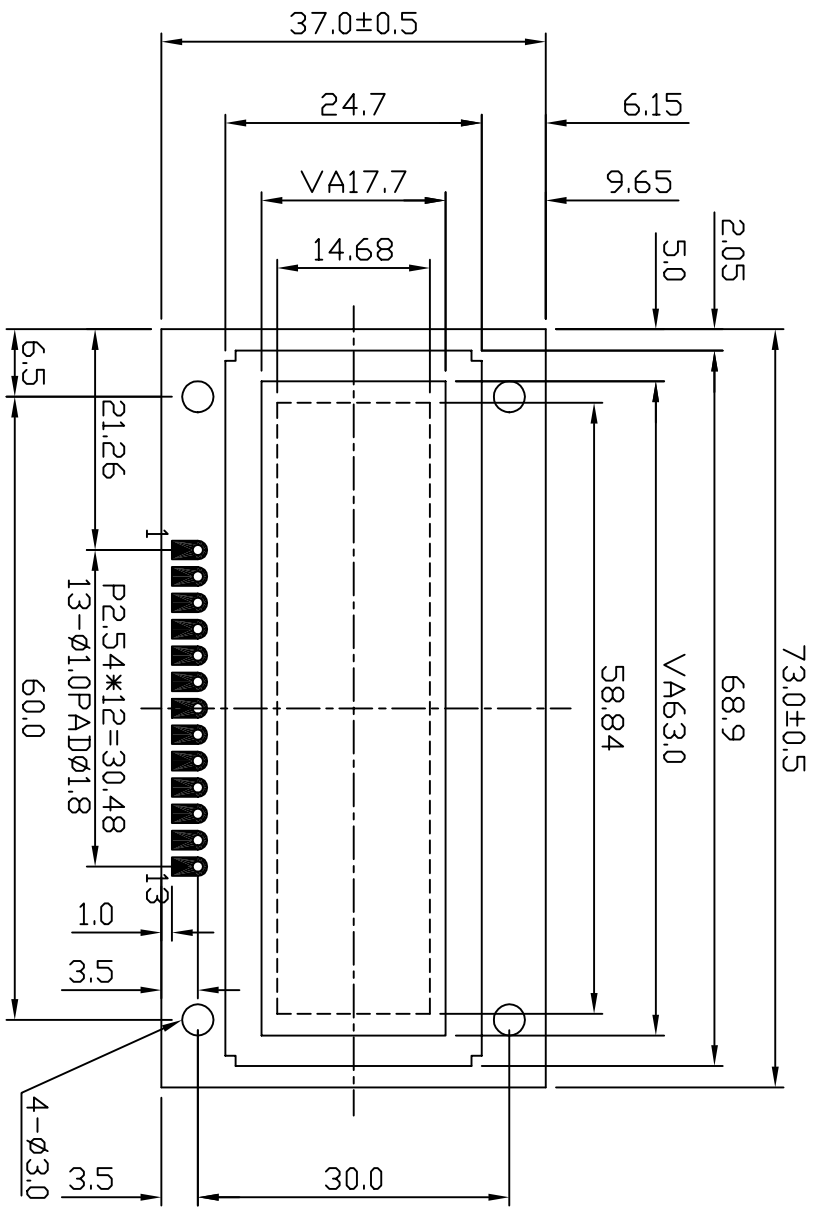

PIN NO	SIGNAL
1	GND
2	+5V
3	LIGHT
4	/CS
5	/WR
6	R/D
7	DB0
8	DB1
9	DB2
10	DB3
11	/CLOCK
12	BZ
13	/BZ

NOTE	ITEM	CONTENT	DATA	REV	TOLERANCE	SCALE	UNIT	DWYN	CUSTOMER	APVL	TITLE	DWG NO	PAGE
		NEW DRAWING	2003.12.03	0	X. ±0.30	1/1	mm	APVD	2004.03.12		MODULE	D-A1-0053	1/1
		CHANGE NUMBER	2004.03.01	0	X ±0.20			CHKD			SG12832B		
		PCB 1.6t	2004.03.12	1	.XX±0.05			Hsu					

SUNLIKE DISPLAY