

Surface
SMT
Mount

.050" MICRO HEADER FTSH SERIES

SPECIFICATIONS

For complete specifications and recommended PCB layouts see www.samtec.com?FTSH

Insulator Material: Black Liquid Crystal Polymer
Terminal Material: Phosphor Bronze
Plating: Sn or Au over 50µ" (1,27µm) Ni
Current Rating: 1.75A @ 80°C ambient
Operating Temp Range: -55°C to +125°C

Processing:
Max Processing Temp: 230°C for 60 seconds, or 260°C for 20 seconds 3x
Lead-Free Solderable: Yes
SMT Lead Coplanarity: (0,10mm) .004" max (02-25) (0,15mm) .006" max (26-50)

Mates with:
FFSD, CLP, FLE, SFMC, SFMH

APPLICATIONS



ALSO AVAILABLE

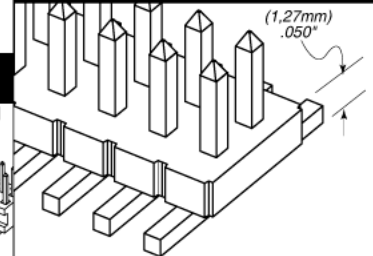

Ultra-low profile option available. End Shrouds available. Call for FTS Series specifications.

APPLICATION SPECIFIC OPTION

Molded pick-and-place pads, latches, single row option and straddle mount leads available. Call Samtec.

OPTIONS

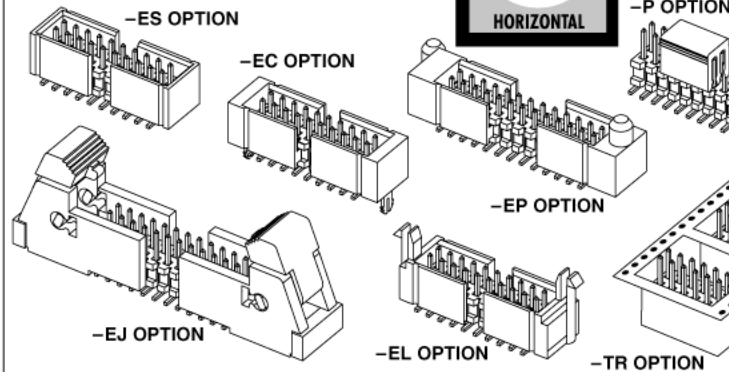

FTSH

1

NO. PINS PER ROW

LEAD STYLE

02 thru 50

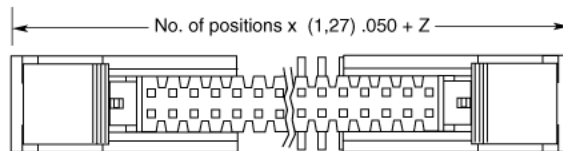
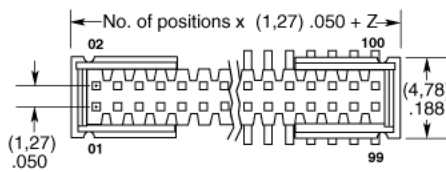

OPTION	Z
-ES	(2,57) .101
-EJ	(15,77) .621
-EC	(3,33) .131
-EP	(5,87) .231
-EL	(6,53) .257

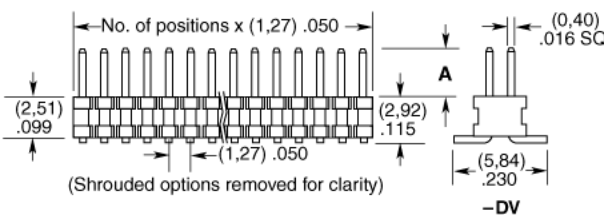

- 01 = (3,05) .120" Post (Mates with FFSD, FLE)
- 02 = (1,91) .075" Post (Mates with FLE)
- 03 = (1,65) .065" Post (Mates with CLP -D)
- 04 = (3,81) .150" Post (Mates with SFMC, SFMH)

LEAD STYLE	A
-01	(3,05) .120
-02	(1,91) .075
-03	(1,65) .065
-04	(3,81) .150

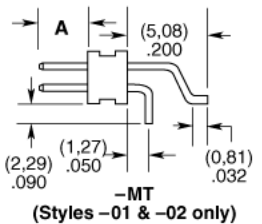
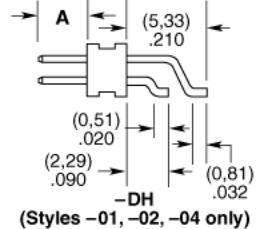

TAPE & REEL AVAILABILITY
 No tooling charges. 125 piece minimum order. Order any quantity above minimum. In-house design, manufacture. Quick turn-around. Call Samtec for specifications and ordering information.

Note: Some sizes, styles and options are non-standard, non-returnable.

Note: See SFM/TFM for positive alignment feature.

Due to technical progress, all designs, specifications and components are subject to change without notice.

WWW.SAMTEC.COM

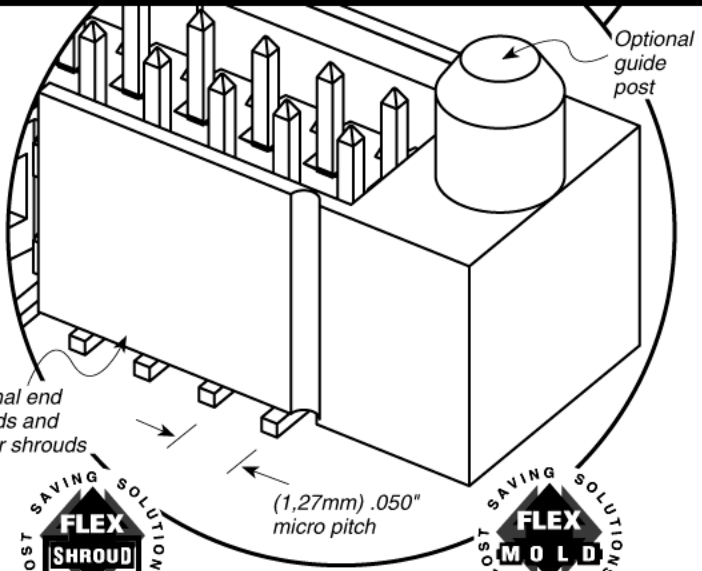
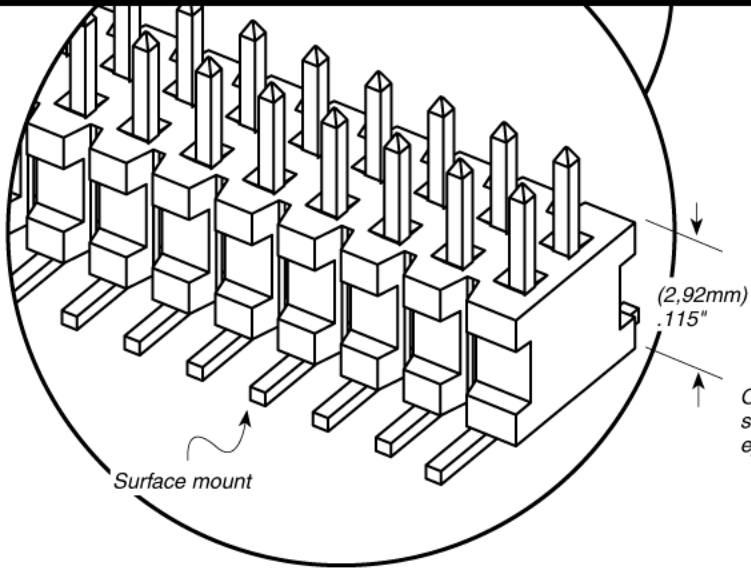
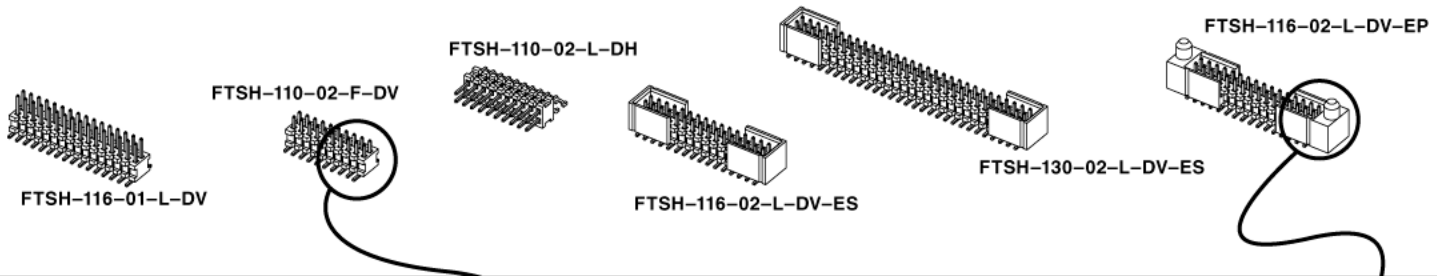

PLATING OPTION

- L**
= 10µ" (0,25µm) Gold on post, Matte Tin on tail
- F**
= Gold flash on post, Matte Tin on tail

TAIL OPTION

- DV**
= Double Vertical
- DH**
= Double Horizontal (Styles -01, -02 & -04 only)
- MT**
= Mixed Technology (Styles -01, -02 & -04 only)

FLEX SHROUD OPTIONS

- (Style -02 & -03 only, -DH not available)
9 pins/row minimum
- ES**
= End Shroud
- EC**
= End Shroud with Locking Clip
- EP**
= End Shroud with Guide Post
- EL**
= End Shroud with Board Lock (Boards are positively locked and cannot be unmated)
- EJ**
= Ejector Shroud (Style -01 only)
-DH & -MT not available
10 pins/row minimum
25 pins/row maximum

OTHER OPTIONS

- K**
= Mating Shroud (For mating with FFSD Styles -01 only, 05, 08, 10, 13, 17, 20 & 25 pins/row only, 13, 17, 20 & 25 only with shrouds)
- A**
= Alignment Pin (-DV 3 positions min.) (-DH 5 positions min.) (Metal or plastic at Samtec discretion)
- C**
= (4,00mm) .157" DIA Polyimide film Pick & Place Pad (-DH only)
- P**
= Pick & Place Pad (-DV 4 positions min.) (-DH & -MT not available)
- TR**
= Tape & Reel Packaging (Tail option -DV & -DH only)
Flex Shroud options not available except -ES & -EJ

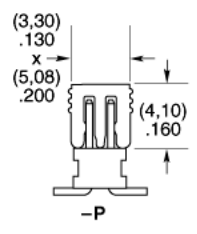
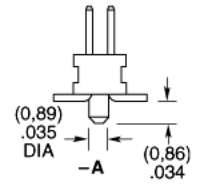
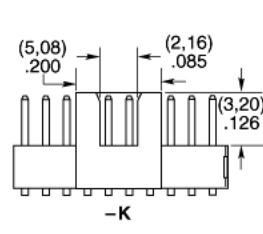
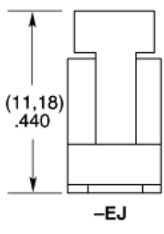
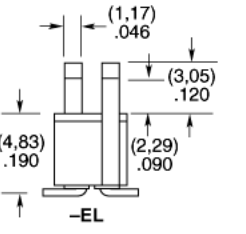
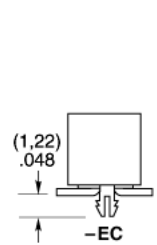
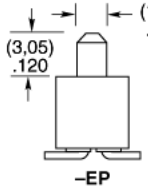
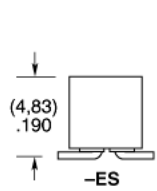

Due to technical progress, all designs, specifications and components are subject to change without notice.

WWW.SAMTEC.COM

SAMTEC USA • Tel: 1-800-SAMTEC-9 or 812-944-6733 • Fax: 812-948-5047
 SAMTEC GERMANY • Tel: +49 (0) 89 / 89460-0 • Fax: +49 (0) 89 / 89460-299
 SAMTEC SCANDINAVIA • Tel: +46-84477280 • Fax: +46-87420413
 SAMTEC ASIA PACIFIC • Tel: 65 6745-5955 • Fax: 65 6841-1502
 SAMTEC HONG KONG • Tel: 852-26904858 • Fax: 852-26904842
 SAMTEC SILICON VALLEY • Tel: 408-395-5900 • Fax: 408-395-1520
 SAMTEC FRANCE • Tel: 01 60 95 06 60 • Fax: 01 60 95 06 61
 SAMTEC ISRAEL • Tel: 972-3-7526600 • Fax: 972-3-7526690
 SAMTEC CHINA • Tel: 86-21-61103766 • Fax: 86-21-53854047
 SAMTEC SOUTH AFRICA • Tel: 27 11 4528112 • Fax: 27 86 6714432
 SAMTEC UK • Tel: 01236 739292 • Fax: 01236 727113
 SAMTEC ITALY • Tel: 39 039 6890337 • Fax: 39 039 6890315
 SAMTEC INDIA • Tel: 91 80 306 21 612 • Fax: 91 80 4152 8187
 SAMTEC JAPAN • Tel: 81-424-42-8318 • Fax: 81-424-42-8319
 SAMTEC TAIWAN • Tel: 886 02 2698-3367 • Fax: 886 02 8698-2159
 SAMTEC ANZ • Tel: 613 9512 7747 • Fax: 613 9512 7745