

LightMOS Power Transistor

- New high voltage technology designed for ZVS-switching in lamp ballasts
- IGBT with integrated reverse diode
- 4A current rating for reverse diode
- Up to 10 times lower gate capacitance than MOSFET
- Avalanche rated
- 150°C operating temperature
- FullPak isolates 2.5 kV AC (1 min.)
- Qualified according to JEDEC¹ for target applications

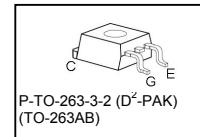
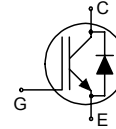

Type	V _{CE}	I _C	V _{CE(sat), T_j=25°C}	T _{j,max}	Package	Ordering Code
ILB03N60	600V	3.0A	2.9V	150°C	P-TO-263-3-2	Q67040-S4627

Maximum Ratings

Parameter	Symbol	Value		Unit
		ILA03N60	Others	
Collector-emitter voltage	V _{CE}	600		V
DC collector current	I _C	T _C = 25°C	4.5	A
		T _C = 100°C	3	
Pulsed collector current, t _p limited by T _{j,max} , t _p < 10 ms	I _{Cpuls}	9		
Pulsed collector current, t _p limited by T _{j,max}		5.5		
Diode forward current	I _F	T _C = 25°C	4	
		T _C = 100°C	2.5	
Diode pulsed current, t _p limited by T _{j,max} , t _p < 10 ms	I _{Fpuls}	9		
Diode pulsed current, t _p limited by T _{j,max}		5.5		
Avalanche energy, single pulse I _C =0.4A, V _{CE} =50V	E _{AS}	0.32		mJ
Gate-emitter voltage	V _{GE}	±30		V
Reverse diode dv/dt I _C ≤ 3A, V _{CE} ≤ 450V, T _{j,max} ≤ 150°C	dv/dt	1 ²		V/ns
Power dissipation (T _C = 25°C)	P _{tot}	27		W
Operating junction and storage temperature	T _{stg}	-55...+150		°C
Soldering temperature (reflow soldering, MSL1)	T _s	220		

¹ J-STD-020 and JESD-022

² Reverse diode of transistor is commutated with same device according to figure C. With application relevant values I_C ≤ 1.5A, C_{Snubber} = 1 nF and R_G ≥ 50Ω, dv/dt of the reverse diode is within its specification.

Thermal Resistance

Parameter	Symbol	Conditions	Max. Value	Unit
Characteristic				
IGBT thermal resistance, junction – case	R_{thJC}		7.6	K/W
			4.7	
Diode thermal resistance, junction – case	R_{thJCD}		12	
			10	
Therm. resistance, junction - ambient	R_{thJA}		65	
			62	
SMD version, device on PCB: @ min. footprint @ 6cm ² cooling area ¹	R_{thJA}		62	
			40	

Electrical Characteristic, at $T_j = 25\text{ }^\circ\text{C}$, unless otherwise specified

Parameter	Symbol	Conditions	Value			Unit
			min.	typ.	max.	
Static Characteristic						
Collector-emitter breakdown voltage	$V_{(BR)CES}$	$V_{GE}=0V, I_C=0.5mA$	600	-	-	V
Collector-emitter avalanche breakdown voltage	$V_{(BR)CE}$	$V_{GS}=0V; I_C=0.4A$	-	850	-	
Collector-emitter saturation voltage	$V_{CE(sat)}$	$V_{GE}=10V, I_C=3.0A$ $T_j=25\text{ }^\circ\text{C}$ $T_j=150\text{ }^\circ\text{C}$	-	2.3	2.9	
			-	2.7		
		$V_{GE}=10V, I_C=0.8A$ $T_j=25\text{ }^\circ\text{C}$ $T_j=150\text{ }^\circ\text{C}$	-	1.5	-	
			-	1.5	-	
Diode forward voltage	V_F	$V_{GE}=0V, I_F=3.0A$ $T_j=25\text{ }^\circ\text{C}$ $T_j=150\text{ }^\circ\text{C}$	-	1.5	1.8	
			-	1.6		
		$V_{GE}=0V, I_F=0.8A$ $T_j=25\text{ }^\circ\text{C}$ $T_j=150\text{ }^\circ\text{C}$	-	1.0	-	
			-	1.0	-	
Gate-emitter threshold voltage	$V_{GE(th)}$	$I_C=30\mu A, V_{CE}=V_{GE}$	2.1	3.0	3.9	V

¹ Device on 40mm*40mm*1.5mm epoxy PCB FR4 with 6cm² (one layer, 70μm thick) copper area for drain connection. PCB is vertical without blown air.

Electrical Characteristic, at $T_j = 25\text{ }^\circ\text{C}$, unless otherwise specified continued

Parameter	Symbol	Conditions	Value			Unit
			min.	typ.	max.	
Zero gate voltage collector current	I_{CES}	$V_{CE}=600\text{V}, V_{GE}=0\text{V}$ $T_j=25\text{ }^\circ\text{C}$ $T_j=150\text{ }^\circ\text{C}$	-	1	20	μA
Gate-emitter leakage current	I_{GES}	$V_{CE}=0\text{V}, V_{GE}=20\text{V}$	-	-	100	nA
Transconductance	g_{fs}	$V_{CE}=20\text{V}, I_C=3.0\text{A}$	-	1.5	-	S

Capacities, Gate Charge, at $T_j=25\text{ }^\circ\text{C}$

Parameter	Symbol	Conditions	Value			Unit
			min.	typ.	max.	
Input capacitance	C_{iss}	$V_{CE}=25\text{V},$	-	110	-	pF
Output capacitance	C_{oss}	$V_{GE}=0\text{V},$	-	6	-	
Reverse transfer capacitance	C_{riss}	$f=1\text{MHz}$	-	4	-	
Effective Output Capacitance (Energy related)	$C_{o(er)}$	$V_{GE}=0\text{V},$ $V_{CE}=0\text{V to }480\text{V}$		3.7		pF
Gate to emitter charge	Q_{GE}	$V_{CE}=400\text{V},$ $I_C=3.0\text{A},$ $V_{GE}=10\text{V}$	-	1	-	nC
Gate to collector charge	Q_{GC}		-	5.5	-	
Gate total charge	Q_G		-	8.5	-	
Gate plateau voltage	V_m		-	6.5	-	
Gate to emitter charge	Q_{GE}	$V_{CE}=400\text{V},$ $I_C=0.8\text{A},$ $V_{GE}=10\text{V}$	-	0.5	-	nC
Gate to collector charge	Q_{GC}		-	4.0	-	
Gate total charge	Q_G		-	8	-	
Gate plateau voltage	V_m		-	3.5	-	

Switching Characteristic, Inductive Load, at $T_j=25\text{ }^\circ\text{C}$

Parameter	Symbol	Conditions	Value			Unit	
			min.	typ.	max.		
IGBT Characteristic							
Turn-on delay time	$t_{d(on)}$	$V_{CC}=400\text{V},$ $I_C=0.8\text{A},$ $V_{GE}=0/10\text{V},$ $R_G=60\Omega,$ $C_{S\text{snubber}}=0\text{nF}$ ($C_{S\text{snubber}}$: Snubber capacitor)	-	15	-	ns	
Rise time	t_r		-	35	-		
Turn-off delay time	$t_{d(off)}$		-	100	-		
Fall time	t_f		-	100	-		
Turn-on energy	E_{on}^4		$C_{S\text{snubber}}=1\text{nF}$	-	12	-	μJ
Turn-off energy	E_{off}			-	20	-	
Turn-off energy	E_{off}	-		8	-		

⁴ E_{on} includes SDP04S60 diode commutation losses

Switching Characteristic, Inductive Load, at $T_j=150\text{ }^\circ\text{C}$

Parameter	Symbol	Conditions	Value			Unit
			min.	typ.	max.	
IGBT Characteristic						
Turn-on delay time	$t_{d(on)}$	$V_{CC}=400\text{V}$, $I_C=0.8\text{A}$, $V_{GE}=0/10\text{V}$, $R_G=60\Omega$, $C_{S\text{nubber}}=0\text{nF}$ ($C_{S\text{nubber}}$: Snubber capacitor)	-	20	-	ns
Rise time	t_r		-	45	-	
Turn-off delay time	$t_{d(off)}$		-	120	-	
Fall time	t_f		-	120	-	
Turn-on energy	E_{on}^3		$C_{S\text{nubber}}=1\text{nF}$	-	15	-
Turn-off energy	E_{off}	-		28	-	
Turn-off energy	E_{off}	-		12	-	

Switching Characteristic, Inductive Load, at $T_j=25\text{ }^\circ\text{C}$

Parameter	Symbol	Conditions	Value			Unit
			min.	typ.	max.	
Reverse diode Characteristic (switching in half bridge configuration with same transistor according to figure C)						
Reverse recovery time	t_{rr}	$V_R=400\text{V}$, $I_F=0.8\text{A}$, $V_{GE}=0/10\text{V}$, $R_G=80\Omega$	-	90	-	ns
Reverse recovery charge	Q_{rr}		-	0.27	-	
Peak reverse recovery current	I_{rrm}		-	5.5	-	A
Peak rate of fall of reverse recovery current	di_{rr}/dt		-	300	-	
Reverse recovery time	t_{rr}	$V_R=400\text{V}$, $I_F=3\text{A}$, $V_{GE}=0/10\text{V}$, $R_G=80\Omega$	-	250	-	ns
Reverse recovery charge	Q_{rr}		-	0.75	-	
Peak reverse recovery current	I_{rrm}		-	8	-	A
Peak rate of fall of reverse recovery current	di_{rr}/dt		-	300	-	

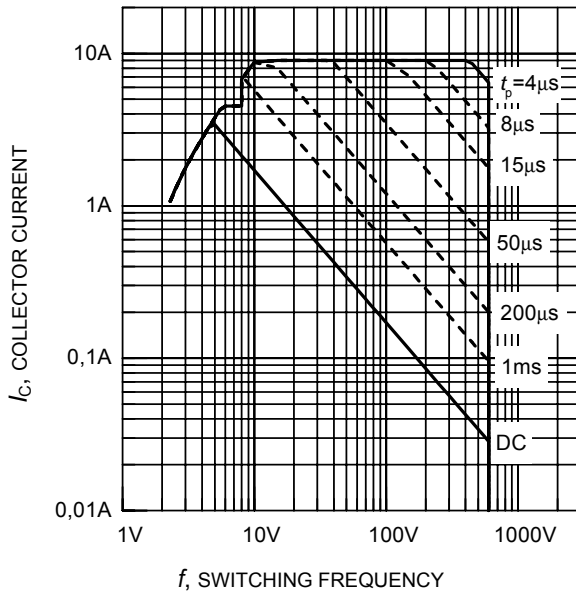

Figure 1: Safe operating area (FullPak)
 ($D = 0, T_C = 25^\circ\text{C}, T_j \leq 150^\circ\text{C}$)

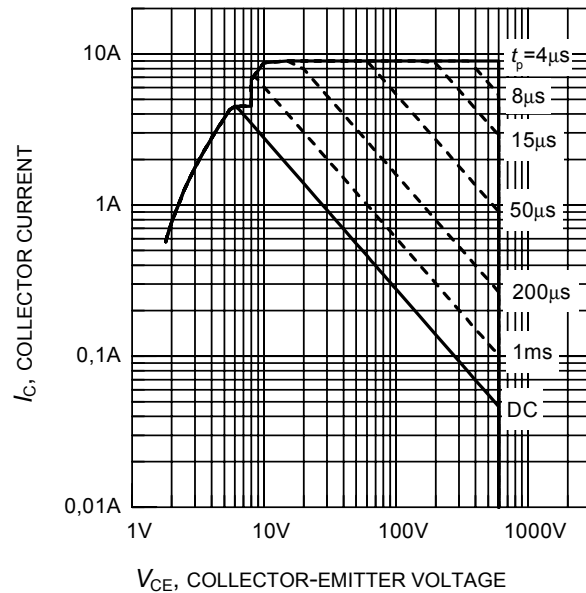

Figure 2: Safe operating area (Other Packages)
 ($D = 0, T_C = 25^\circ\text{C}, T_j \leq 150^\circ\text{C}$)

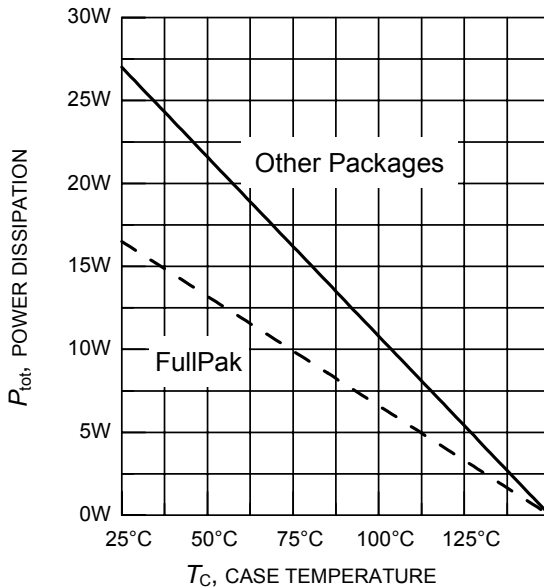

Figure 3. Power dissipation as a function of case temperature
 ($T_j \leq 150^\circ\text{C}$)

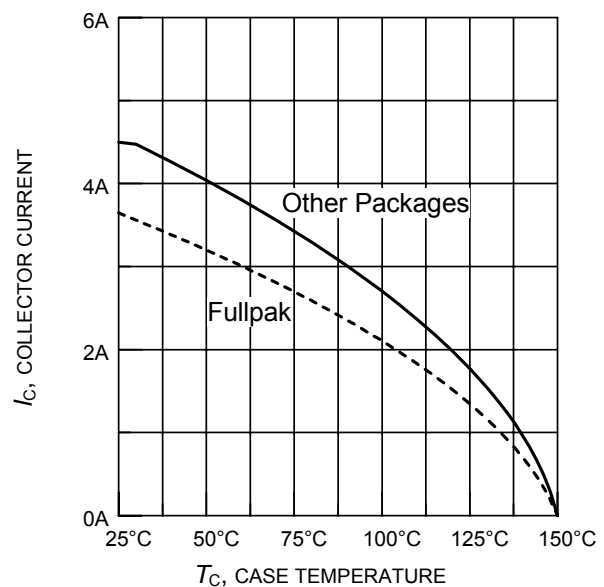

Figure 4. Collector current as a function of case temperature
 ($V_{GE} \leq 10\text{V}, T_j \leq 150^\circ\text{C}$)

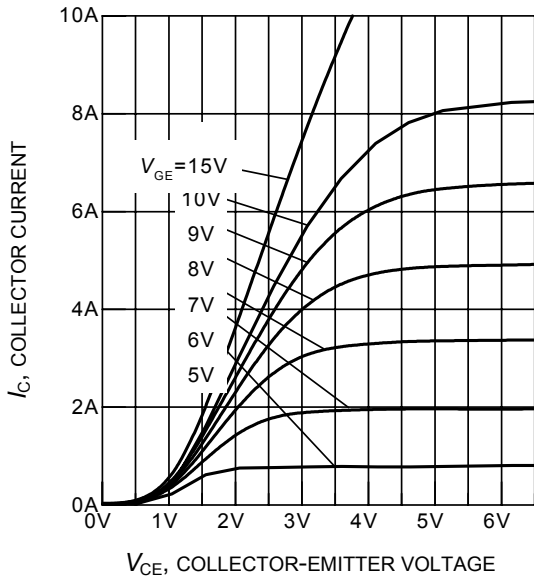

Figure 5. Typical output characteristics
($T_j = 25^\circ\text{C}$)

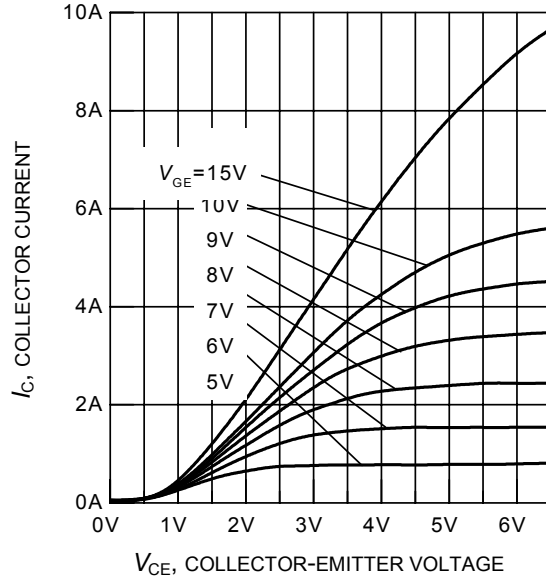

Figure 6. Typical output characteristics
($T_j = 150^\circ\text{C}$)

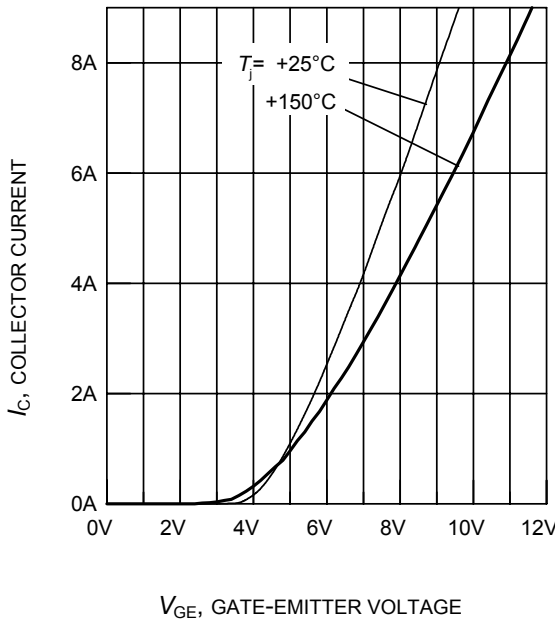

Figure 7. Typical transfer characteristics
($V_{CE} = 20\text{V}$)

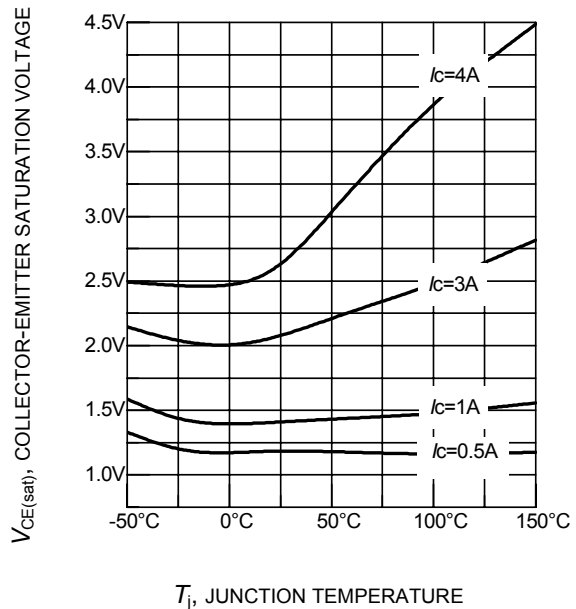

Figure 8. Typical collector-emitter saturation voltage as a function of junction temperature
($V_{GE} = 10\text{V}$)

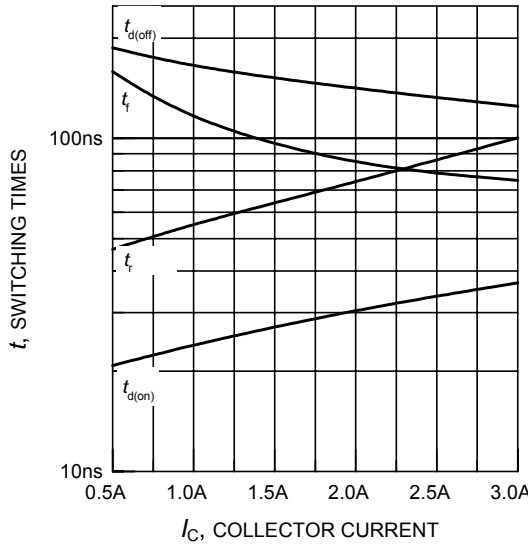

Figure 9. Typical switching times as a function of collector current
 (inductive load, $T_j = 150^\circ\text{C}$, $V_{CE} = 400\text{V}$,
 $V_{GE} = 0/+10\text{V}$, $R_G = 80\Omega$,
 Dynamic test circuit in Figure E)

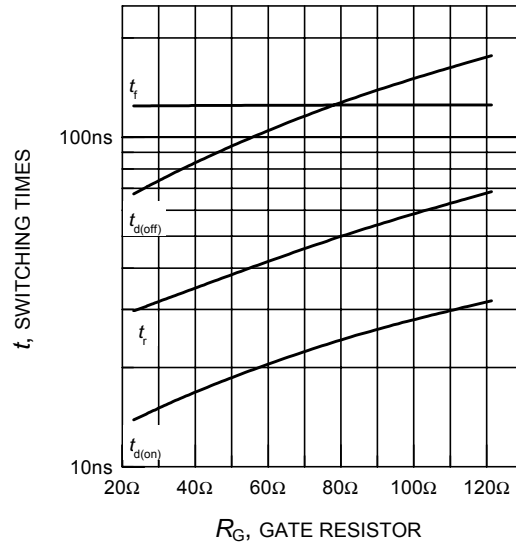

Figure 10. Typical switching times as a function of gate resistor
 (inductive load, $T_j = 150^\circ\text{C}$, $V_{CE} = 400\text{V}$,
 $V_{GE} = 0/+10\text{V}$, $I_C = 1\text{A}$,
 Dynamic test circuit in Figure E)

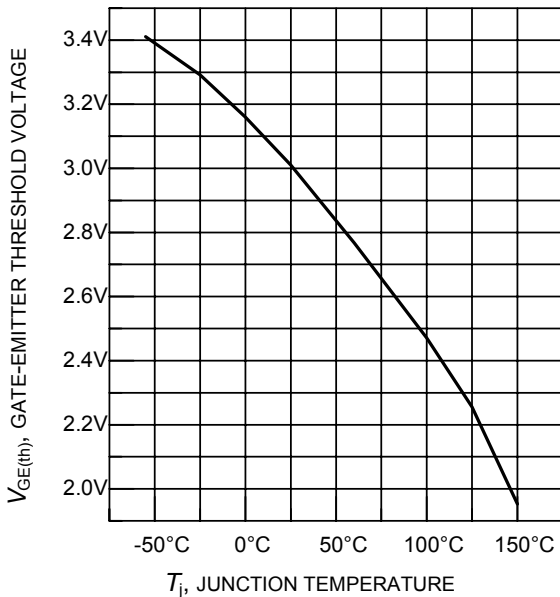

Figure 12. Gate-emitter threshold voltage as a function of junction temperature
 ($I_C = 30\mu\text{A}$)

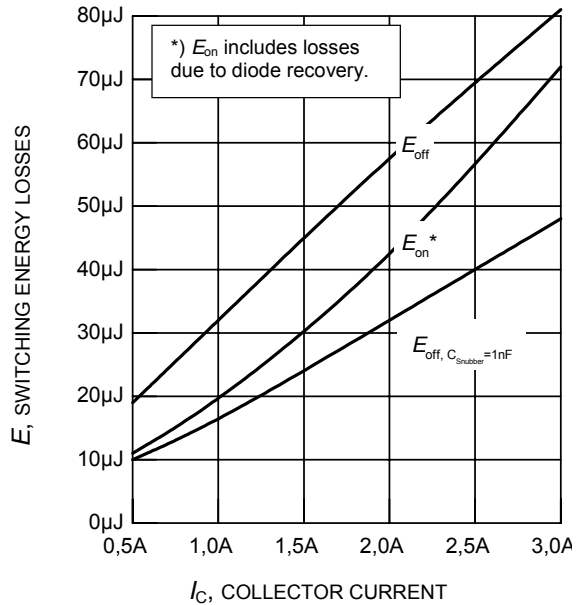

Figure 13. Typical switching energy losses as a function of collector current
 (inductive load, $T_j = 150^\circ\text{C}$, $V_{CE} = 400\text{V}$,
 $V_{GE} = 0/+10\text{V}$, $R_G = 80\Omega$, $C_{Snubber}=0/1\text{nF}$
 Dynamic test circuit in Figure E)

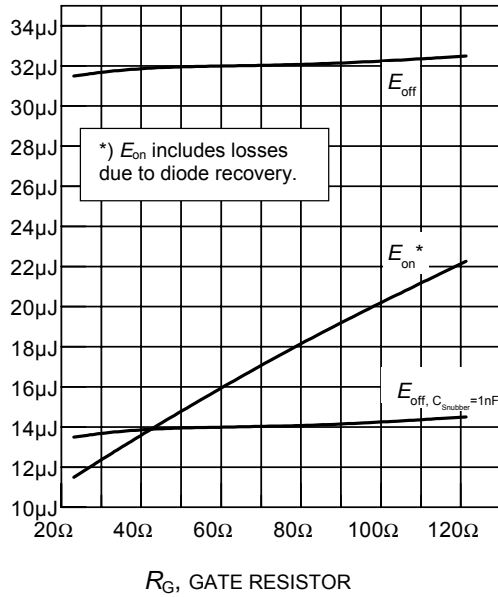

Figure 14. Typical switching energy losses as a function of gate resistor
 (inductive load, $T_j = 150^\circ\text{C}$, $V_{CE} = 400\text{V}$, $V_{GE} = 0/+10\text{V}$, $I_C = 1\text{A}$, $C_{Snubber} = 0/1\text{nF}$
 Dynamic test circuit in Figure E)

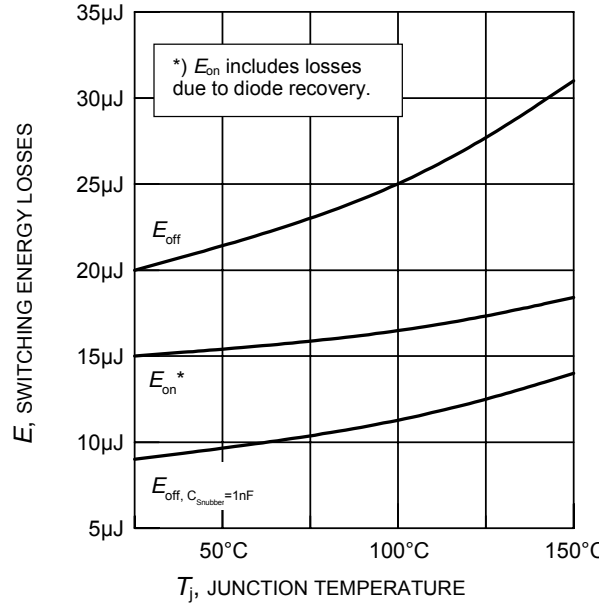

Figure 15. Typical switching energy losses as a function of junction temperature
 (inductive load, $V_{CE} = 400\text{V}$, $V_{GE} = 0/+10\text{V}$, $I_C = 1\text{A}$, $R_G = 80\Omega$, $C_{Snubber} = 0/1\text{nF}$
 Dynamic test circuit in Figure E)

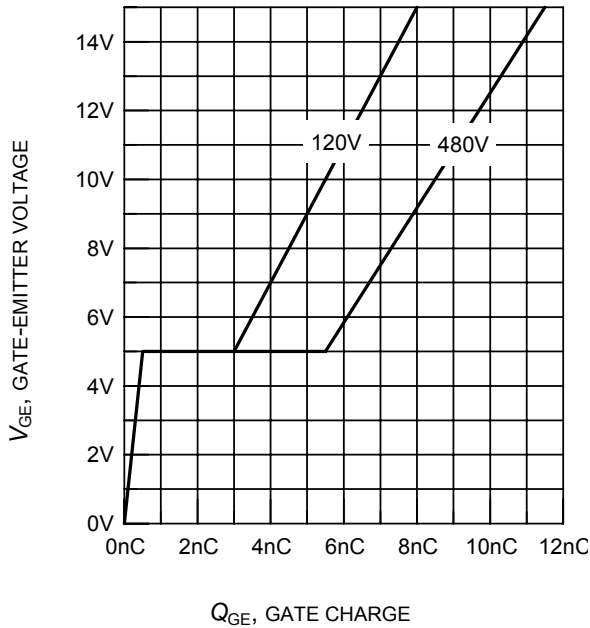

Figure 16. Typical gate charge
 ($I_C = 0.8\text{A}$)

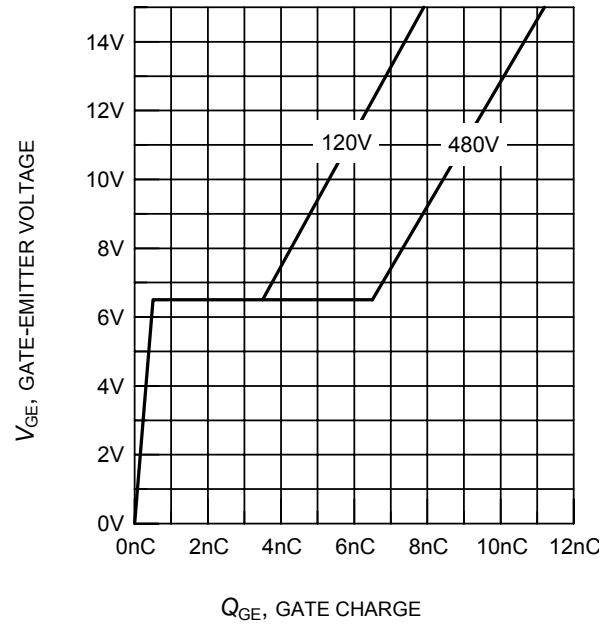

Figure 17. Typical gate charge
 ($I_C = 3\text{A}$)

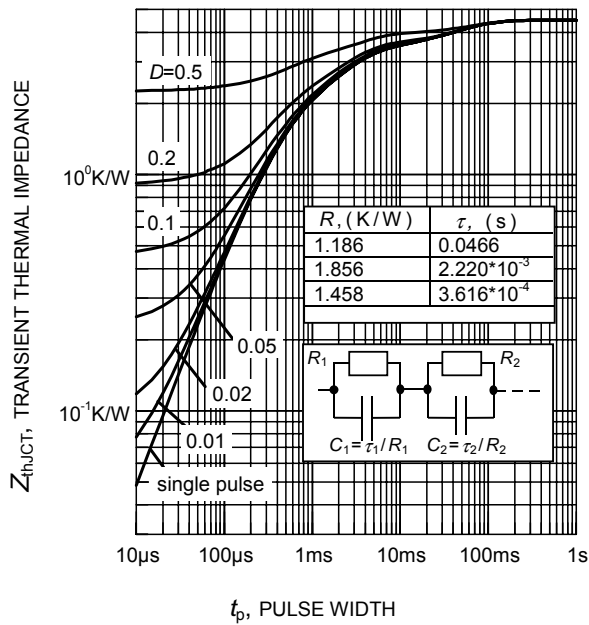

Figure 18: IGBT transient thermal impedance as a function of pulse width ($D = t_p / T$)

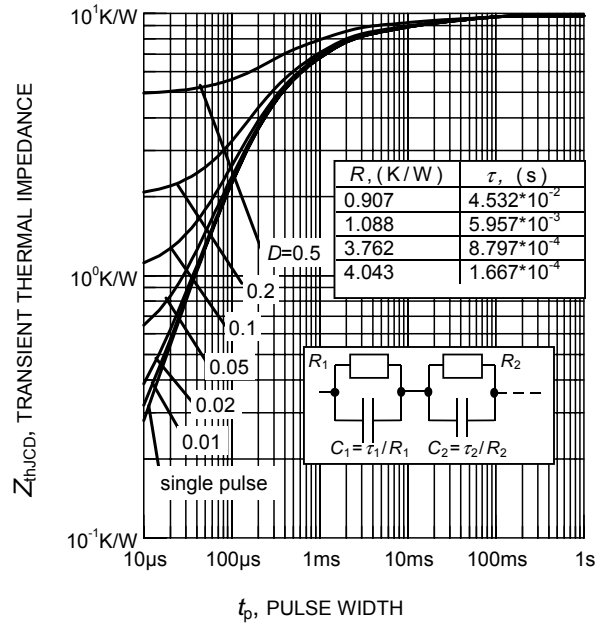

Figure 19: Diode transient thermal impedance as a function of pulse width ($D = t_p / T$)

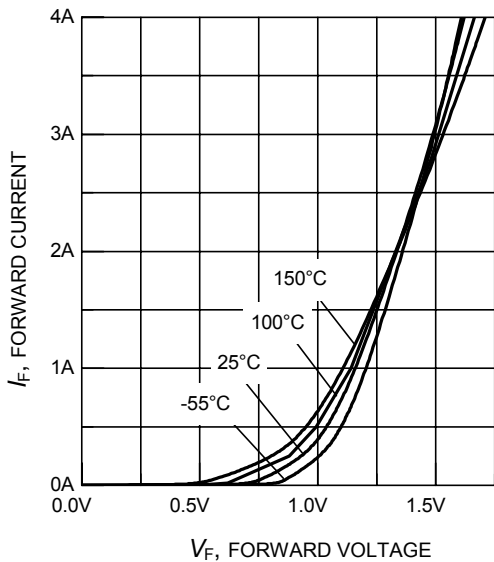

Figure 20. Typical diode forward current as a function of forward voltage

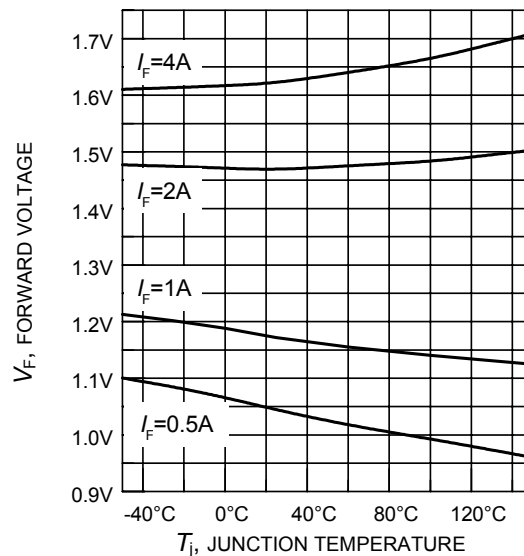

Figure 21. Typical diode forward voltage as a function of junction temperature

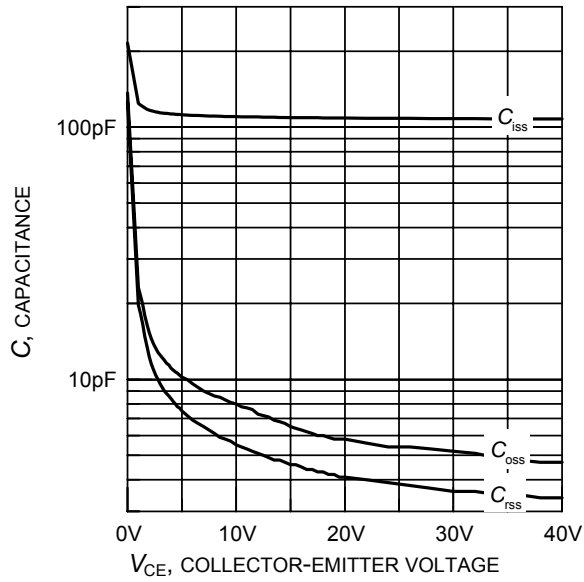

Figure 22. Typical capacitance as a function of collector-emitter voltage
 ($V_{GE} = 0V, f = 1MHz$)

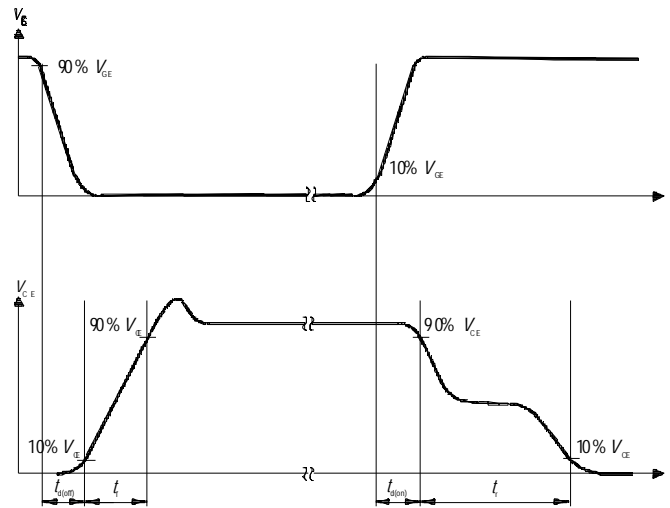

Figure A. Definition of switching times

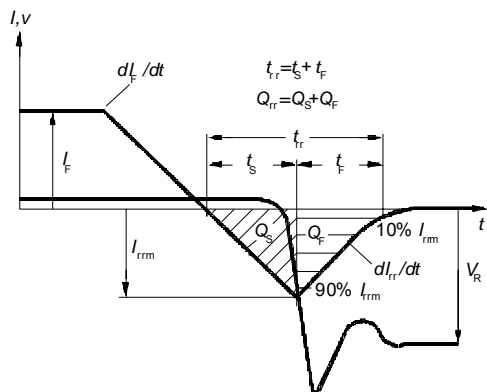

Figure B. Definition of diodes switching characteristics

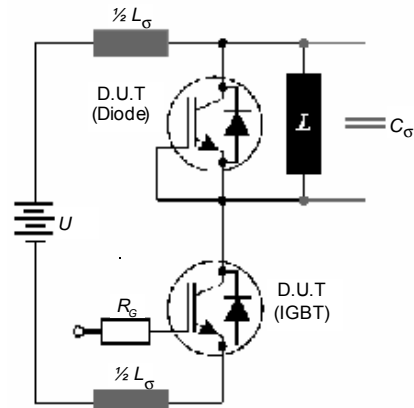
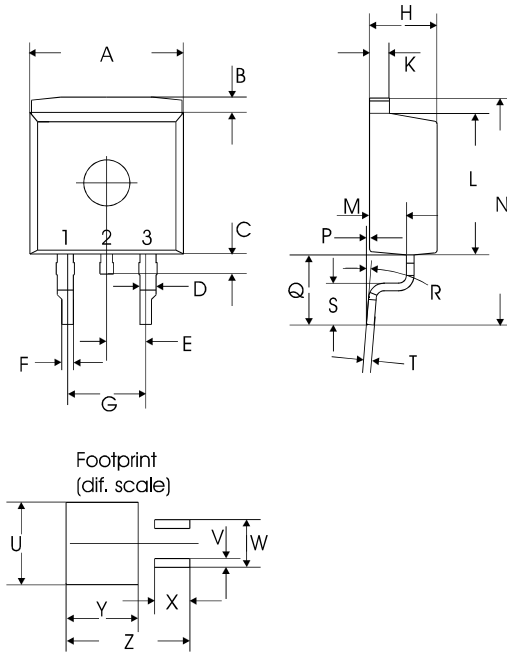

Figure C. Dynamic test circuit

TO-263AB (D²Pak)



symbol	dimensions			
	[mm]		[inch]	
	min	max	min	max
A	9.80	10.20	0.3858	0.4016
B	0.70	1.30	0.0276	0.0512
C	1.00	1.60	0.0394	0.0630
D	1.03	1.07	0.0406	0.0421
E	2.54 typ.		0.1 typ.	
F	0.65	0.85	0.0256	0.0335
G	5.08 typ.		0.2 typ.	
H	4.30	4.50	0.1693	0.1772
K	1.17	1.37	0.0461	0.0539
L	9.05	9.45	0.3563	0.3720
M	2.30	2.50	0.0906	0.0984
N	15 typ.		0.5906 typ.	
P	0.00	0.20	0.0000	0.0079
Q	4.20	5.20	0.1654	0.2047
R	8° max		8° max	
S	2.40	3.00	0.0945	0.1181
T	0.40	0.60	0.0157	0.0236
U	10.80		0.4252	
V	1.15		0.0453	
W	6.23		0.2453	
X	4.60		0.1811	
Y	9.40		0.3701	
Z	16.15		0.6358	

Published by
Infineon Technologies AG,
Bereich Kommunikation
St.-Martin-Strasse 53,
D-81541 München
© Infineon Technologies AG 2003
All Rights Reserved.

Attention please!

The information herein is given to describe certain components and shall not be considered as warranted characteristics.

Terms of delivery and rights to technical change reserved.

We hereby disclaim any and all warranties, including but not limited to warranties of non-infringement, regarding circuits, descriptions and charts stated herein.

Infineon Technologies is an approved CECC manufacturer.

Information

For further information on technology, delivery terms and conditions and prices please contact your nearest Infineon Technologies Office in Germany or our Infineon Technologies Representatives worldwide (see address list).

Warnings

Due to technical requirements components may contain dangerous substances. For information on the types in question please contact your nearest Infineon Technologies Office.

Infineon Technologies Components may only be used in life-support devices or systems with the express written approval of Infineon Technologies, if a failure of such components can reasonably be expected to cause the failure of that life-support device or system, or to affect the safety or effectiveness of that device or system. Life support devices or systems are intended to be implanted in the human body, or to support and/or maintain and sustain and/or protect human life. If they fail, it is reasonable to assume that the health of the user or other persons may be endangered.