

Features

Max supply voltage	V_{CC}	41 V
Operating voltage range	V_{CC}	4.5 V to 28 V
Max ON-state resistance (per ch.)	R_{ON}	160 m Ω
Current limitation (typ)	I_{LIMH}	10 A
OFF-state supply current	I_S	2 μ A ⁽¹⁾

1. Typical value with all loads connected.

- General
 - Inrush current active management by power limitation
 - Very low standby current
 - 3.0 V CMOS compatible inputs
 - Optimized electromagnetic emission
 - Very low electromagnetic susceptibility
 - In compliance with the 2002/95/EC european directive
 - Very low current sense leakage
- Diagnostic functions
 - Proportional load current sense
 - High-precision current sense for wide currents range
 - Current sense disable
 - Overload and short to ground (power limitation) indication
 - Thermal shutdown indication
- Protections
 - Undervoltage shutdown
 - Overvoltage clamp
 - Load current limitation
 - Self-limiting of fast thermal transients
 - Protection against loss of ground and loss of V_{CC}
 - Overtemperature shutdown with autorestart (thermal shutdown)
 - Reverse battery protected (see [Figure 29](#))

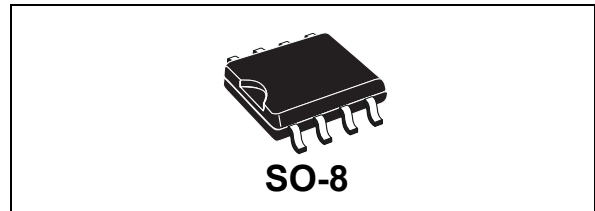

- Electrostatic discharge protection

Applications

- All types of resistive, inductive and capacitive loads
- Suitable as LED driver

Description

The VN5E160MS-E is a single-channel high-side driver manufactured in the ST proprietary VIPower M0-5 technology and housed in the tiny SO-8 package. The VN5E160MS-E is designed to drive 12 V automotive grounded loads delivering protection, diagnostics and easy 3 V and 5 V CMOS compatible interface with any microcontroller.

The device integrates advanced protective functions such as load current limitation, inrush and overload active management by power limitation, overtemperature shut-off with auto-restart and overvoltage active clamp. A dedicated analog current sense pin is associated with every output channel in order to provide enhanced diagnostic functions including fast detection of overload and short-circuit to ground through power limitation indication and overtemperature indication.

The current sensing and diagnostic feedback of the whole device can be disabled by pulling the CS_DIS pin high to allow sharing of the external sense resistor with other similar devices.

Contents

1	Block diagram and pin configuration	5
2	Electrical specifications	7
2.1	Absolute maximum ratings	7
2.2	Thermal data	8
2.3	Electrical characteristics	9
2.4	Waveforms	18
2.5	Electrical characteristics curves	20
3	Application information	23
3.1	GND protection network against reverse battery	23
3.1.1	Solution 1: resistor in the ground line (RGND only)	23
3.1.2	Solution 2: a diode (DGND) in the ground line	24
3.2	Load dump protection	24
3.3	MCU I/Os protection	24
3.4	Current sense and diagnostic	25
3.5	Maximum demagnetization energy (VCC = 13.5 V)	26
4	Package and PCB thermal data	27
4.1	SO-8 thermal data	27
5	Package and packing information	30
5.1	ECOPACK®	30
5.2	Package mechanical data	30
5.3	Packing information	32
6	Order codes	33
7	Revision history	34

List of tables

Table 1.	Pin function	5
Table 2.	Suggested connections for unused and not connected pins	6
Table 3.	Absolute maximum ratings	7
Table 4.	Thermal data	8
Table 5.	Power section	9
Table 6.	Switching ($V_{CC} = 13\text{ V}$; $T_j = 25\text{ °C}$)	9
Table 7.	Logic inputs	10
Table 8.	Protection and diagnostics	10
Table 9.	Current sense ($8\text{ V} < V_{CC} < 18\text{ V}$)	11
Table 10.	Truth table	16
Table 11.	Electrical transient requirements (part 1)	17
Table 12.	Electrical transient requirements (part 2)	17
Table 13.	Electrical transient requirements (part 3)	17
Table 14.	Thermal parameters	29
Table 15.	SO-8 mechanical data	31
Table 16.	Device summary	33
Table 17.	Document revision history	34

List of figures

Figure 1.	Block diagram	5
Figure 2.	Configuration diagram (top view)	6
Figure 3.	Current and voltage conventions ⁽¹⁾	7
Figure 4.	Current sense delay characteristics	13
Figure 5.	Switching characteristics	13
Figure 6.	Output voltage drop limitation	13
Figure 7.	Delay response time between rising edge of output current and rising edge of current sense (CS enabled).	14
Figure 8.	I_{OUT}/I_{SENSE} vs I_{OUT}	15
Figure 9.	Maximum current sense ratio drift vs load current ⁽¹⁾	15
Figure 10.	Normal operation	18
Figure 11.	Overload or short to GND	18
Figure 12.	Intermittent overload	19
Figure 13.	T_J evolution in overload or short to GND	19
Figure 14.	OFF-state output current	20
Figure 15.	High-level input current	20
Figure 16.	Input voltage clamp	20
Figure 17.	Low-level input voltage	20
Figure 18.	High-level input voltage	20
Figure 19.	Hysteresis input voltage	20
Figure 20.	ON-state resistance vs. T_{case}	21
Figure 21.	ON-state resistance vs. V_{CC}	21
Figure 22.	Undervoltage shutdown	21
Figure 23.	Turn-on voltage slope	21
Figure 24.	I_{LIMH} vs. T_{case}	21
Figure 25.	Turn-off voltage slope	21
Figure 26.	High-level CS_DIS voltage	22
Figure 27.	CS_DIS voltage clamp	22
Figure 28.	Low-level CS_DIS voltage	22
Figure 29.	Application schematic	23
Figure 30.	Current sense and diagnostic	25
Figure 31.	Maximum turn-off current versus inductance (for each channel) ⁽¹⁾	26
Figure 32.	SO-8 PC board ⁽¹⁾	27
Figure 33.	$R_{thj-amb}$ vs. PCB copper area in open box free air condition	27
Figure 34.	SO-8 thermal impedance junction ambient single pulse	28
Figure 35.	Thermal fitting model of an HSD in SO-8 ⁽¹⁾	28
Figure 36.	SO-8 package dimensions	30
Figure 37.	SO-8 tube shipment (no suffix)	32
Figure 38.	SO-8 tape and reel shipment (suffix "TR")	32

1 Block diagram and pin configuration

Figure 1. Block diagram

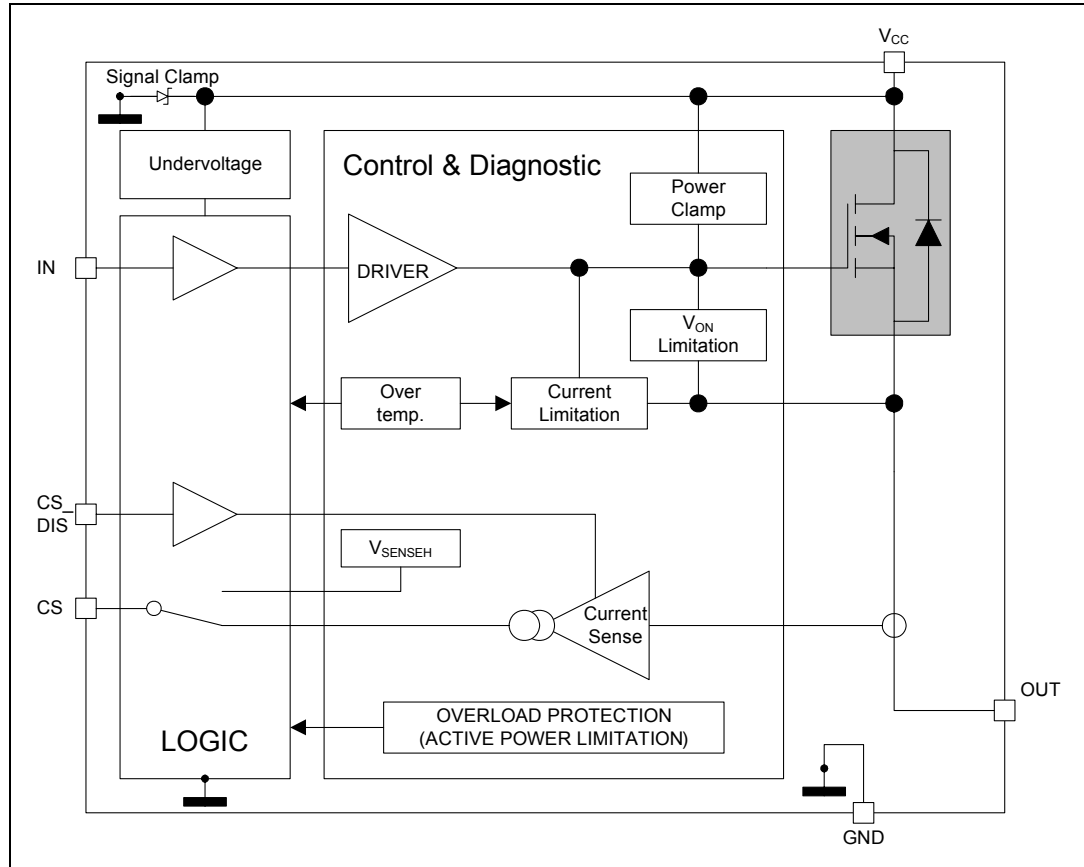

Table 1. Pin function

Name	Function
V _{CC}	Battery connection
OUT	Power output
GND	Ground connection. Must be reverse battery protected by an external diode/resistor network
IN	Voltage-controlled input pin with hysteresis, CMOS compatible. Controls output switch state
CS	Analog current sense pin, delivers a current proportional to the load current
CS_DIS	Active high CMOS compatible pin, to disable the current sense pin

Figure 2. Configuration diagram (top view)

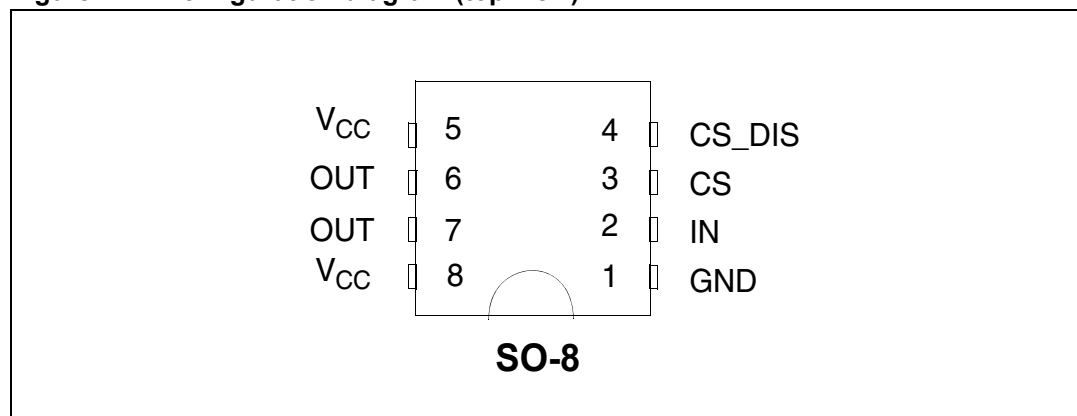
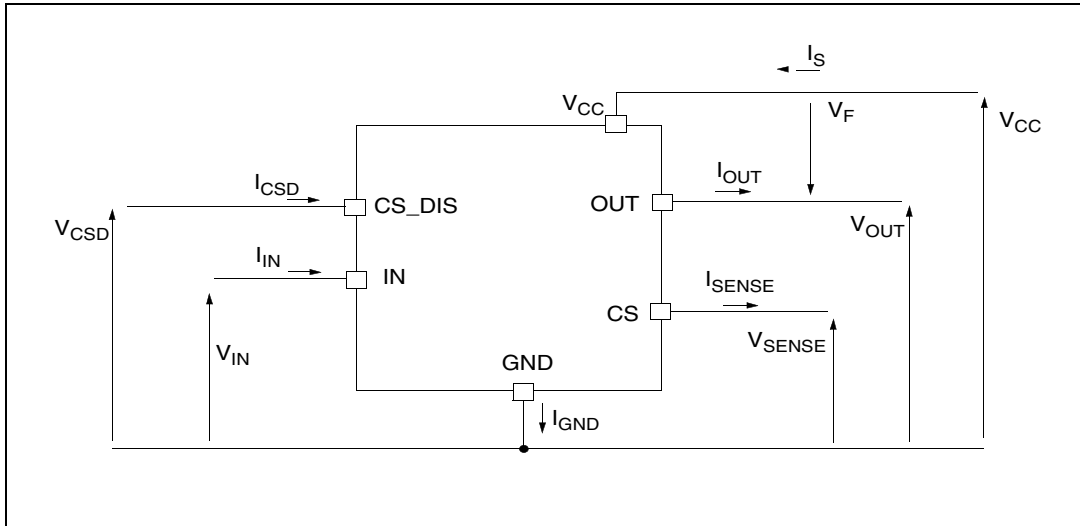

Table 2. Suggested connections for unused and not connected pins

Connection / pin	Current sense	N.C.	Output	Input	CS_DIS
Floating	Not allowed	X	X	X	X
To ground	Through 1 k Ω resistor	X	Not allowed	Through 10 k Ω resistor	Through 10 k Ω resistor

2 Electrical specifications

Figure 3. Current and voltage conventions⁽¹⁾



1. $V_F = V_{OUT} - V_{CC}$ during reverse battery condition.

2.1 Absolute maximum ratings

Stressing the device above the ratings listed in the [Table 3: Absolute maximum ratings](#) may cause permanent damage to the device. These are stress ratings only and operation of the device at these or any other conditions above those indicated in the operating sections of this specification is not implied. Exposure to the conditions in the [Table 3: Absolute maximum ratings](#) for extended periods may affect device reliability. Refer also to the STMicroelectronics SURE program and other relevant quality documents.

Table 3. Absolute maximum ratings

Symbol	Parameter	Value	Unit
V _{CC}	DC supply voltage	41	V
-V _{CC}	Reverse DC supply voltage	0.3	V
-I _{GND}	DC reverse ground pin current	200	mA
I _{OUT}	DC output current	Internally limited	A
-I _{OUT}	Reverse DC output current	6	A
I _{IN}	DC input current	-1 to 10	mA
I _{CSD}	DC current sense disable input current	-1 to 10	mA
-I _{CSENSE}	DC reverse CS pin current	200	mA
V _{CSENSE}	Current sense maximum voltage	V _{CC} - 41 +V _{CC}	V V

Table 3. Absolute maximum ratings (continued)

Symbol	Parameter	Value	Unit
E_{MAX}	Maximum switching energy (single pulse) ($L = 8 \text{ mH}$; $R_L = 0 \text{ }\Omega$; $V_{bat} = 13.5 \text{ V}$; $T_{jstart} = 150 \text{ }^\circ\text{C}$; $I_{OUT} = I_{limL}(Typ.)$)	36	mJ
V_{ESD}	Electrostatic discharge (human body model: $R = 1.5 \text{ K}\Omega$; $C = 100 \text{ pF}$)		
	- IN	4000	V
	- CS	2000	V
	- CS_DIS	4000	V
	- OUT	5000	V
	- V_{CC}	5000	V
V_{ESD}	Charge device model (CDM-AEC-Q100-011)	750	V
T_j	Junction operating temperature	-40 to 150	$^\circ\text{C}$
T_{stg}	Storage temperature	-55 to 150	$^\circ\text{C}$

2.2 Thermal data

Table 4. Thermal data

Symbol	Parameter	Max value	Unit
$R_{thj-pins}$	Thermal resistance junction-pins	30	$^\circ\text{C}/\text{W}$
$R_{thj-amb}$	Thermal resistance junction-ambient	See Figure 33	$^\circ\text{C}/\text{W}$

2.3 Electrical characteristics

Values specified in this section are for $8\text{ V} < V_{CC} < 28\text{ V}$; $-40\text{ °C} < T_j < 150\text{ °C}$, unless otherwise stated.

Table 5. Power section

Symbol	Parameter	Test conditions	Min.	Typ.	Max.	Unit
V_{CC}	Operating supply voltage		4.5	13	28	V
V_{USD}	Undervoltage shutdown			3.5	4.5	V
$V_{USDhyst}$	Undervoltage shutdown hysteresis			0.5		V
R_{ON}	ON-state resistance	$I_{OUT} = 1\text{ A}$, $T_j = 25\text{ °C}$			160	mΩ
		$I_{OUT} = 1\text{ A}$, $T_j = 150\text{ °C}$			320	
		$I_{OUT} = 1\text{ A}$, $V_{CC} = 5\text{ V}$, $T_j = 25\text{ °C}$			210	
V_{clamp}	Voltage clamp	$I_S = 20\text{ mA}$	41	46	52	V
I_S	Supply current	OFF-state: $V_{CC} = 13\text{ V}$, $V_{IN} = V_{OUT} = 0\text{ V}$, $T_j = 25\text{ °C}$		2 ⁽¹⁾	5 ⁽¹⁾	μA
		ON-state: $V_{IN} = 5\text{ V}$, $V_{CC} = 13\text{ V}$, $I_{OUT} = 0\text{ A}$		1.9	3.5	mA
$I_{L(off1)}$	OFF-state output current	$V_{IN} = V_{OUT} = 0\text{ V}$, $V_{CC} = 13\text{ V}$, $T_j = 25\text{ °C}$	0	0.01	3	μA
		$V_{IN} = V_{OUT} = 0\text{ V}$, $V_{CC} = 13\text{ V}$, $T_j = 125\text{ °C}$	0		5	
V_F	Output - V_{CC} diode voltage	$-I_{OUT} = 1\text{ A}$, $T_j = 150\text{ °C}$			0.7	V

1. PowerMOS leakage included.

Table 6. Switching ($V_{CC} = 13\text{ V}$; $T_j = 25\text{ °C}$)

Symbol	Parameter	Test conditions	Min.	Typ.	Max.	Unit
$t_{d(on)}$	Turn-on delay time	$R_L = 13\text{ Ω}$ (see Figure 5)	-	10	-	μs
$t_{d(off)}$	Turn-off delay time	$R_L = 13\text{ Ω}$ (see Figure 5)	-	10	-	μs
$dV_{OUT}/dt_{(on)}$	Turn-on voltage slope	$R_L = 13\text{ Ω}$	-	See Figure 23	-	V/μs
$dV_{OUT}/dt_{(off)}$	Turn-off voltage slope	$R_L = 13\text{ Ω}$	-	See Figure 25	-	V/μs
W_{ON}	Switching energy losses during t_{won}	$R_L = 13\text{ Ω}$ (see Figure 5)	-	0.05	-	mJ
W_{OFF}	Switching energy losses during t_{woff}	$R_L = 13\text{ Ω}$ (see Figure 5)	-	0.03	-	mJ

Table 7. Logic inputs

Symbol	Parameter	Test conditions	Min.	Typ.	Max.	Unit
V_{IL}	Low-level input voltage				0.9	V
I_{IL}	Low-level input current	$V_{IN} = 0.9\text{ V}$	1			μA
V_{IH}	High-level input voltage		2.1			V
I_{IH}	High-level input current	$V_{IN} = 2.1\text{ V}$			10	μA
$V_{I(hyst)}$	Input voltage hysteresis		0.25			V
V_{ICL}	Input voltage clamp	$I_{IN} = 1\text{ mA}$	5.5		7	V
		$I_{IN} = -1\text{ mA}$		-0.7		
V_{CSDL}	Low-level CS_DIS voltage				0.9	V
I_{CSDL}	Low-level CS_DIS current	$V_{CSD} = 0.9\text{ V}$	1			μA
V_{CSDH}	High-level CS_DIS voltage		2.1			V
I_{CSDH}	High-level CS_DIS current	$V_{CSD} = 2.1\text{ V}$			10	μA
$V_{CSD(hyst)}$	CS_DIS voltage hysteresis		0.25			V
V_{CSCL}	CS_DIS voltage clamp	$I_{CSD} = 1\text{ mA}$	5.5		7	V
		$I_{CSD} = -1\text{ mA}$		-0.7		

Table 8. Protection and diagnostics⁽¹⁾

Symbol	Parameter	Test conditions	Min.	Typ.	Max.	Unit
I_{limH}	DC short-circuit current	$V_{CC} = 13\text{ V}$	7	10	14	A
		$5\text{ V} < V_{CC} < 28\text{ V}$			14	A
I_{limL}	Short-circuit current during thermal cycling	$V_{CC} = 13\text{ V}$ $T_R < T_j < T_{TSD}$		2.5		A
T_{TSD}	Shutdown temperature		150	175	200	$^{\circ}\text{C}$
T_R	Reset temperature		$T_{RS} + 1$	$T_{RS} + 5$		$^{\circ}\text{C}$
T_{RS}	Thermal reset of STATUS		135			$^{\circ}\text{C}$
T_{HYST}	Thermal hysteresis ($T_{TSD} - T_R$)			7		$^{\circ}\text{C}$
V_{DEMAG}	Turn-off output voltage clamp	$I_{OUT} = 1\text{ A}$, $V_{IN} = 0$, $L = 20\text{ mH}$	$V_{CC} - 41$	$V_{CC} - 46$	$V_{CC} - 52$	V
V_{ON}	Output voltage drop limitation	$I_{OUT} = 0.03\text{ A}$ (see Figure 8) $T_j = -40\text{ }^{\circ}\text{C}$ to $+150\text{ }^{\circ}\text{C}$		25		mV

1. To ensure long term reliability under heavy overload or short-circuit conditions, protection and related diagnostic signals must be used together with a proper software strategy. If the device is subjected to abnormal conditions, this software must limit the duration and number of activation cycles.

Table 9. Current sense (8 V < V_{CC} < 18 V)

Symbol	Parameter	Test conditions	Min.	Typ.	Max.	Unit
K ₀	I _{OUT} /I _{SENSE}	I _{OUT} = 0.025 A, V _{SENSE} = 0.5 V T _j = -40 °C to 150 °C	265	490	715	
K ₁	I _{OUT} /I _{SENSE}	I _{OUT} = 0.35 A, V _{SENSE} = 0.5 V T _j = -40 °C to 150 °C T _j = 25 °C to 150 °C	355 385	465 465	575 545	
dK ₁ /K ₁ ⁽¹⁾	Current sense ratio drift	I _{OUT} = 0.35 A, V _{SENSE} = 0.5 V T _j = -40 °C to 150 °C	-11		+11	%
K ₂	I _{OUT} /I _{SENSE}	I _{OUT} = 0.5 A, V _{SENSE} = 4 V T _j = -40 °C to 150 °C T _j = 25 °C to 150 °C	380 400	455 455	530 510	
dK ₂ /K ₂ ⁽¹⁾	Current sense ratio drift	I _{OUT} = 0.5 A; T _j = -40 °C to 150 °C	-8		+8	%
K ₃	I _{OUT} /I _{SENSE}	I _{OUT} = 1.5 A, V _{SENSE} = 4 V T _j = -40 °C to 150 °C T _j = 25 °C to 150 °C	420 420	455 455	490 480	
dK ₃ /K ₃ ⁽¹⁾	Current sense ratio drift	I _{OUT} = 1.5 A; T _j = -40 °C to 150 °C	-4		+4	%
I _{SENSE0}	Analog sense leakage current	I _{OUT} = 0 A, V _{SENSE} = 0 V, V _{CSD} = 5 V, V _{IN} = 0 V, T _j = -40 °C to 150 °C	0		1	μA
		I _{OUT} = 0 A, V _{SENSE} = 0 V, V _{CSD} = 0 V, V _{IN} = 5 V, T _j = -40 °C to 150 °C	0		2	
		I _{OUT} = 1 A, V _{SENSE} = 0 V, V _{CSD} = 5 V, V _{IN} = 5 V, T _j = -40 °C to 150 °C	0		1	
I _{OL}	ON-state open-load current detection threshold	V _{IN} = 5 V, 8 V < V _{CC} < 18 V I _{SENSE} = 5 μA	0.5		5	mA
V _{SENSE}	Max analog sense output voltage	R _{SENSE} = 10 KΩ I _{OUT} = 1 A;	5			V
V _{SENSEH} ⁽²⁾	Analog sense output voltage in fault condition	V _{CC} = 13 V, R _{SENSE} = 3.9 KΩ		8		V
I _{SENSEH} ⁽²⁾	Analog sense output current in fault condition	V _{CC} = 13 V, V _{SENSE} = 5 V		9		mA
t _{DSENSE1H}	Delay response time from falling edge of CS_DIS pin	V _{SENSE} < 4 V, 0.025 A < I _{OUT} < 1.5 A I _{SENSE} = 90% of I _{SENSE} max (see Figure 4)		40	100	μs

Table 9. Current sense ($8\text{ V} < V_{CC} < 18\text{ V}$) (continued)

Symbol	Parameter	Test conditions	Min.	Typ.	Max.	Unit
t_{DSENSE1L}	Delay response time from rising edge of CS_DIS pin	$V_{\text{SENSE}} < 4\text{ V}$, $0.025\text{ A} < I_{\text{OUT}} < 1.5\text{ A}$ $I_{\text{SENSE}} = 10\%$ of $I_{\text{SENSE max}}$ (see Figure 4)		5	20	μs
t_{DSENSE2H}	Delay response time from rising edge of IN pin	$V_{\text{SENSE}} < 4\text{ V}$, $0.025\text{ A} < I_{\text{OUT}} < 1.5\text{ A}$ $I_{\text{SENSE}} = 90\%$ of $I_{\text{SENSE max}}$ (see Figure 4)		120	300	μs
$\Delta t_{\text{DSENSE2H}}$	Delay response time between rising edge of output current and rising edge of current sense	$V_{\text{SENSE}} < 4\text{ V}$, $I_{\text{SENSE}} = 90\%$ of I_{SENSEMAX} , $I_{\text{OUT}} = 90\%$ of I_{OUTMAX} $I_{\text{OUTMAX}} = 1.5\text{ A}$ (see Figure 7)			110	μs
t_{DSENSE2L}	Delay response time from falling edge of IN pin	$V_{\text{SENSE}} < 4\text{ V}$, $0.025\text{ A} < I_{\text{OUT}} < 1.5\text{ A}$ $I_{\text{SENSE}} = 10\%$ of $I_{\text{SENSE max}}$ (see Figure 4)		80	250	μs

- Parameter guaranteed by design; it is not tested.
- Fault condition includes: power limitation and overtemperature.

Figure 4. Current sense delay characteristics

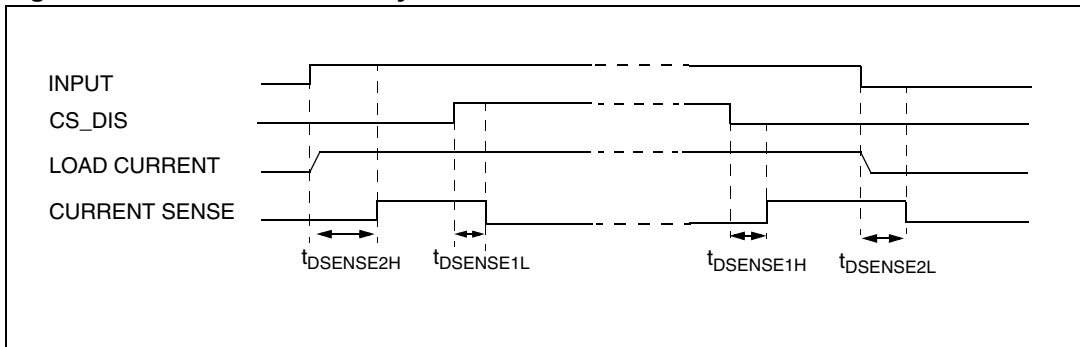

Figure 5. Switching characteristics

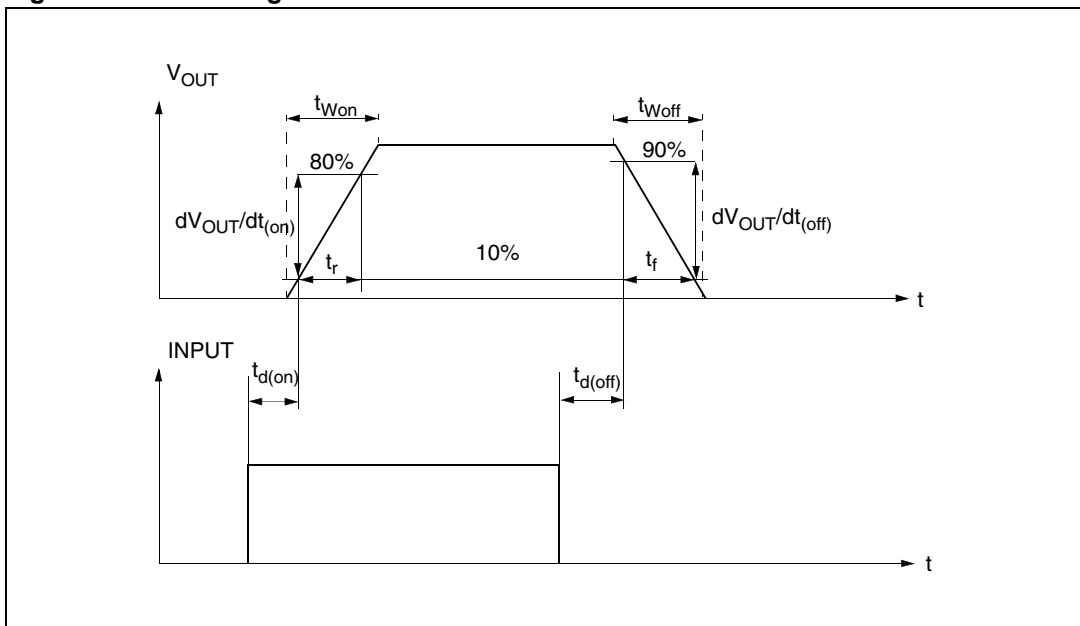

Figure 6. Output voltage drop limitation

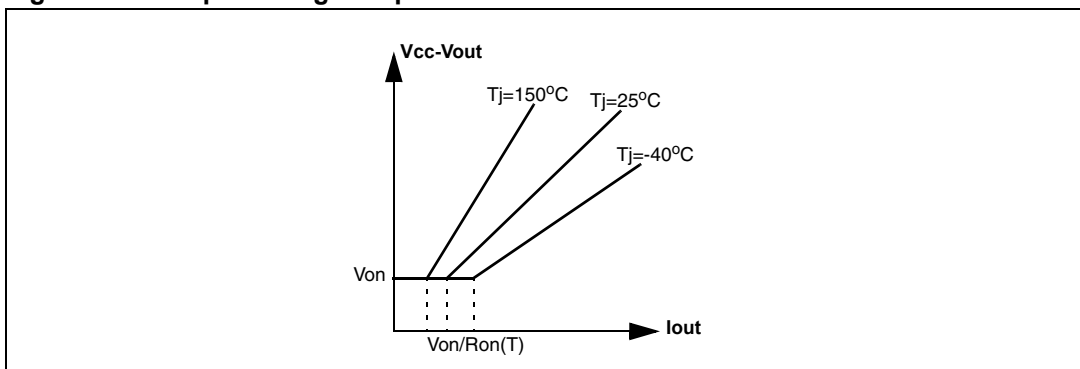

Figure 7. Delay response time between rising edge of output current and rising edge of current sense (CS enabled)

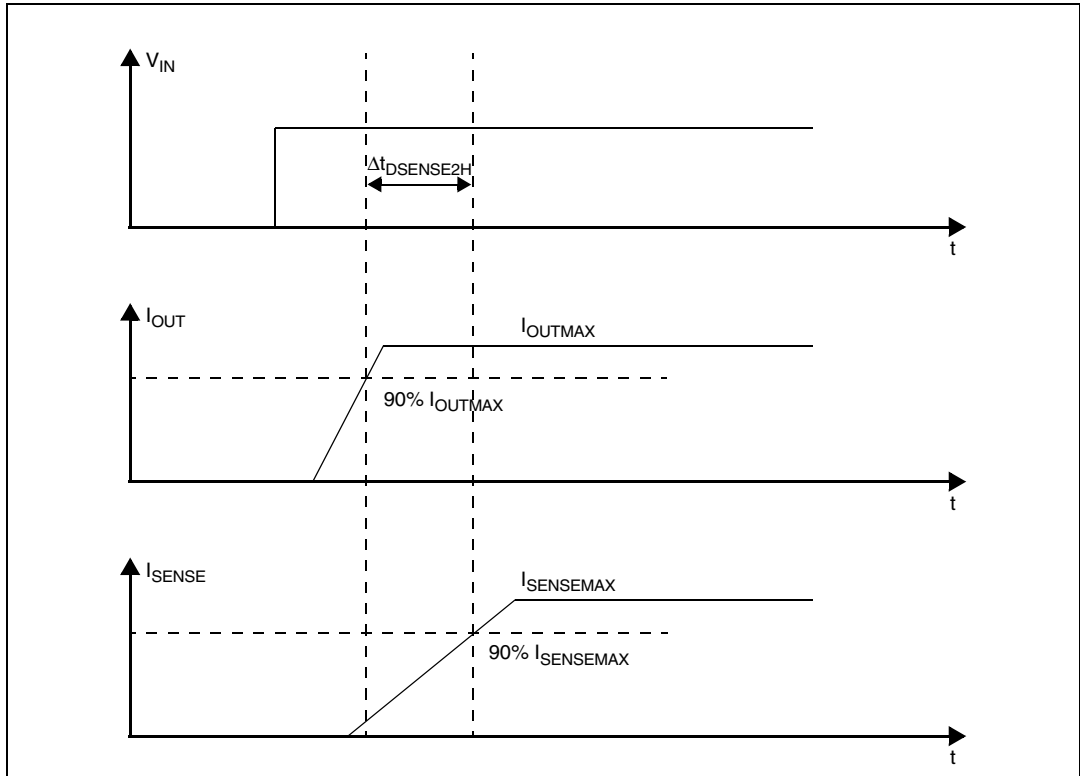

Figure 8. I_{OUT}/I_{SENSE} vs I_{OUT}

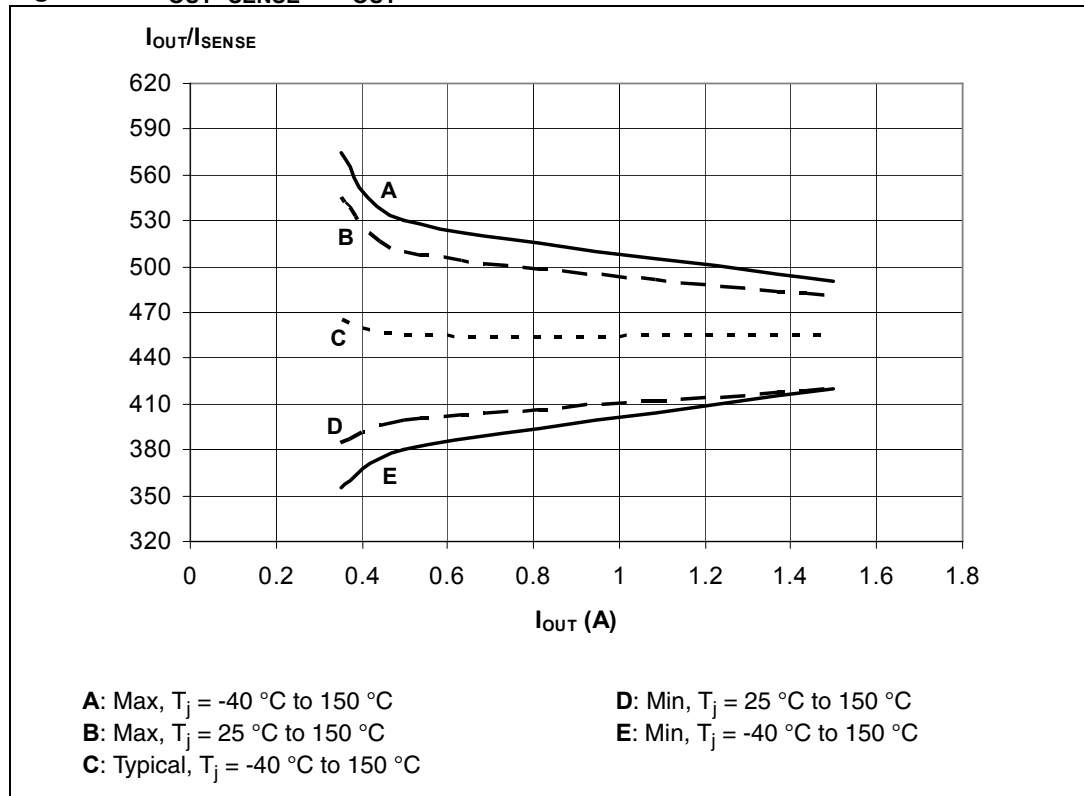
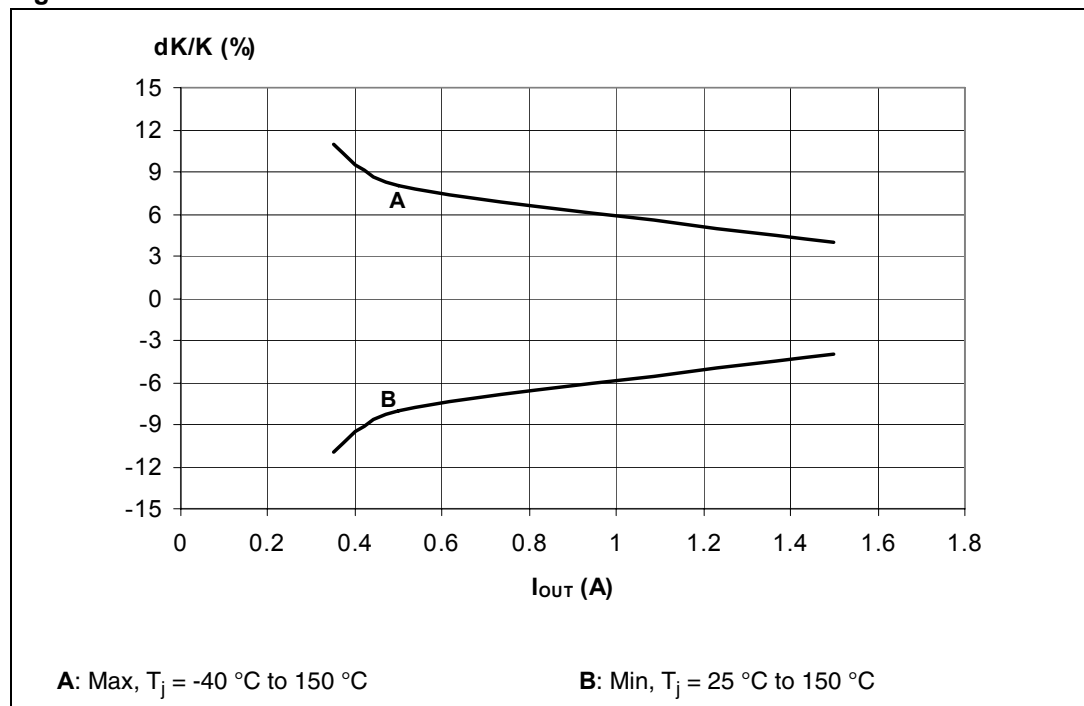

Figure 9. Maximum current sense ratio drift vs load current⁽¹⁾



1. Parameter guaranteed by design; it is not tested.

Table 10. Truth table

Conditions	IN	OUT	SENSE ($V_{CSD} = 0\text{ V}$) ⁽¹⁾
Normal operation	L	L	0
	H	H	Nominal
Overtemperature	L	L	0
	H	L	V_{SENSEH}
Undervoltage	L	L	0
	H	L	0
Overload	H	X (no power limitation)	Nominal
	H	Cycling (power limitation)	V_{SENSEH}
Short-circuit to GND (Power limitation)	L	L	0
	H	L	V_{SENSEH}
Negative output voltage clamp	L	L	0

1. If the V_{CSD} is high, the SENSE output is at a high impedance, its potential depends on leakage currents and external circuit.

Table 11. Electrical transient requirements (part 1)

ISO 7637-2: 2004(E) Test pulse	Test levels ⁽¹⁾		Number of pulses or test times	Burst cycle/pulse repetition time		Delays and Impedance
	III	IV				
1	-75 V	-100 V	5000 pulses	0.5 s	5 s	2 ms, 10 Ω
2a	+37 V	+50 V	5000 pulses	0.2 s	5 s	50 μs, 2 Ω
3a	-100 V	-150 V	1h	90 ms	100 ms	0.1 μs, 50 Ω
3b	+75 V	+100 V	1h	90 ms	100 ms	0.1 μs, 50 Ω
4	-6 V	-7 V	1 pulse			100 ms, 0.01 Ω
5b ⁽²⁾	+65 V	+87 V	1 pulse			400 ms, 2 Ω

Table 12. Electrical transient requirements (part 2)

ISO 7637-2: 2004(E) Test pulse	Test level results ⁽¹⁾	
	III	IV
1	C	C
2a	C	C
3a	C	C
3b	C	C
4	C	C
5b ⁽²⁾	C	C

1. The above test levels must be considered referred to $V_{CC} = 13.5$ V except for pulse 5b

2. Valid in case of external load dump clamp: 40 V maximum referred to ground.

Table 13. Electrical transient requirements (part 3)

Class	Contents
C	All functions of the device are performed as designed after exposure to disturbance.
E	One or more functions of the device are not performed as designed after exposure to disturbance and cannot be returned to proper operation without replacing the device.

2.4 Waveforms

Figure 10. Normal operation

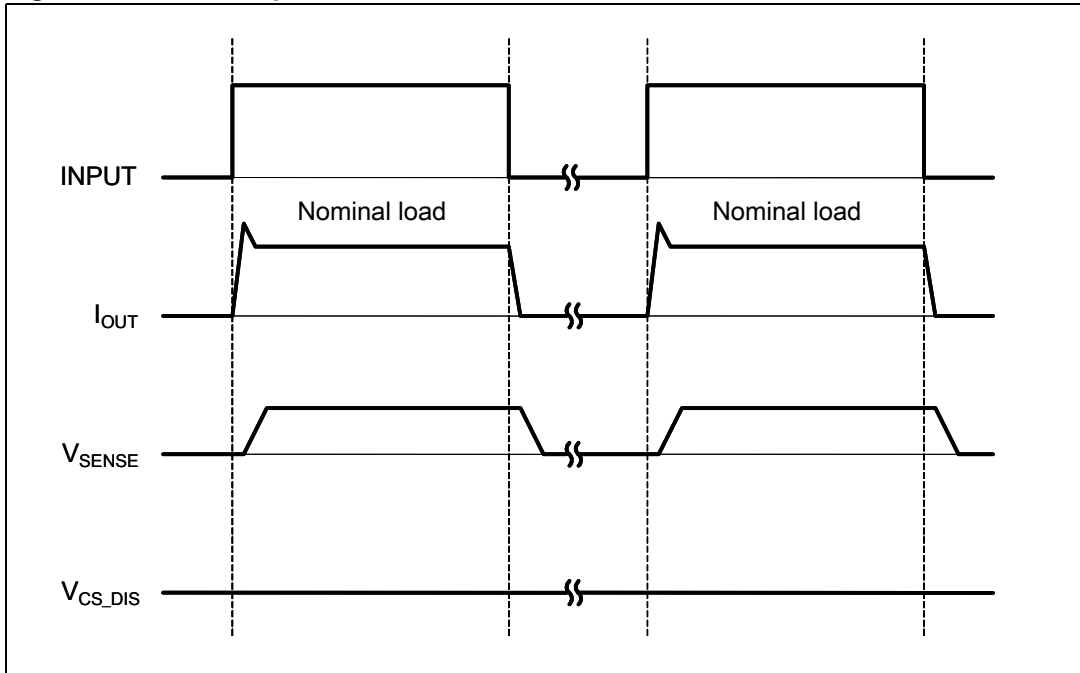

Figure 11. Overload or short to GND

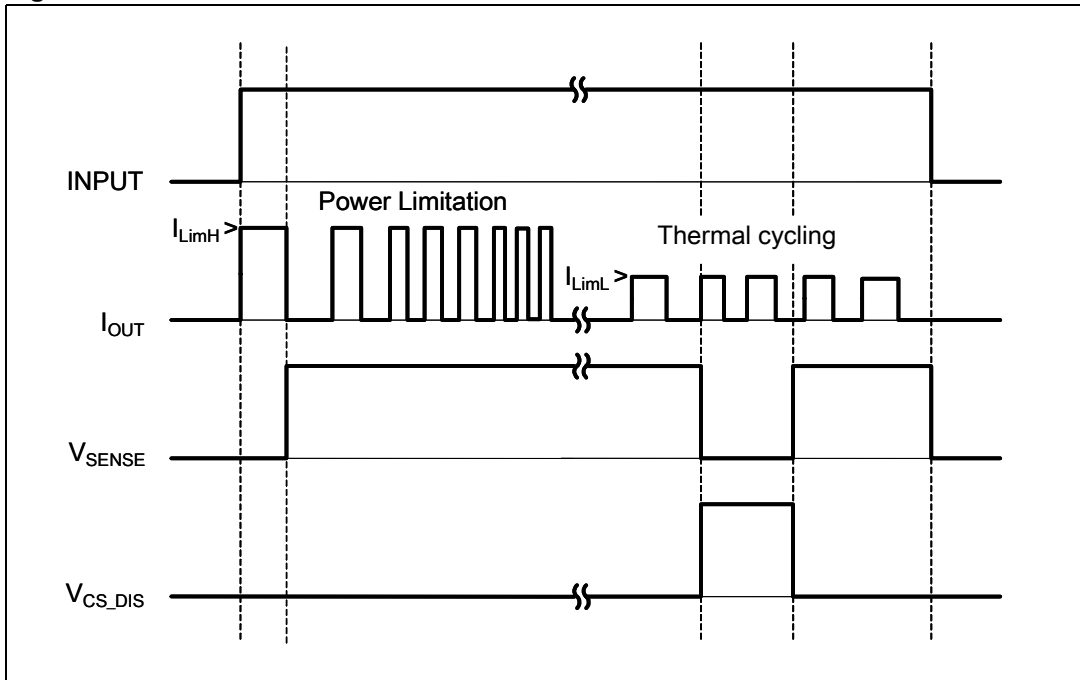

Figure 12. Intermittent overload

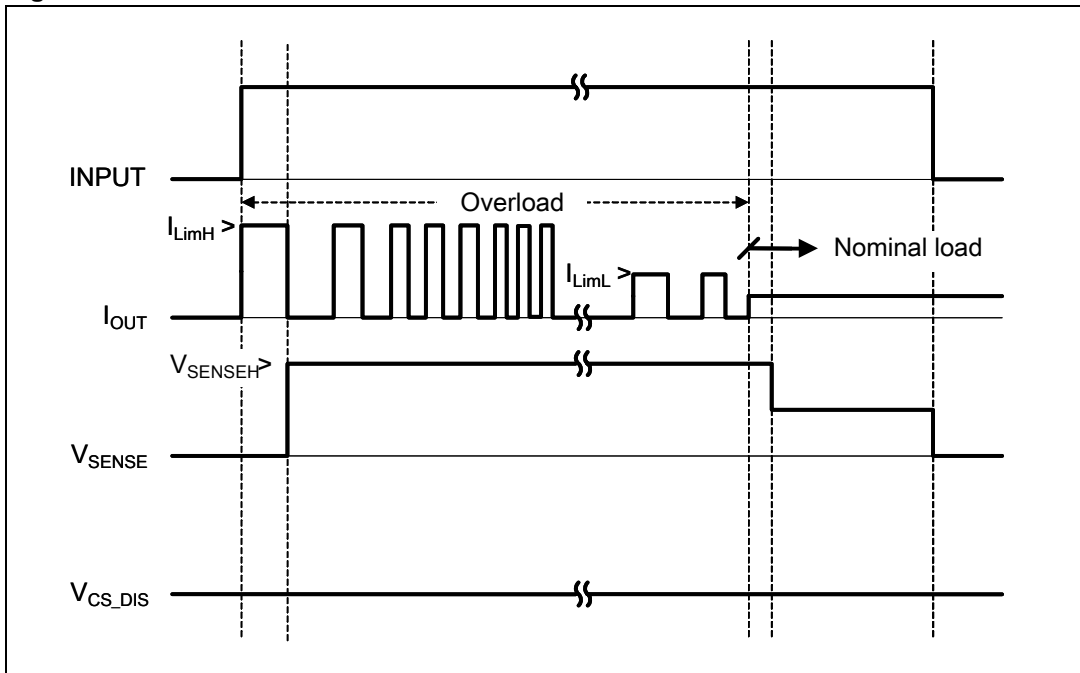
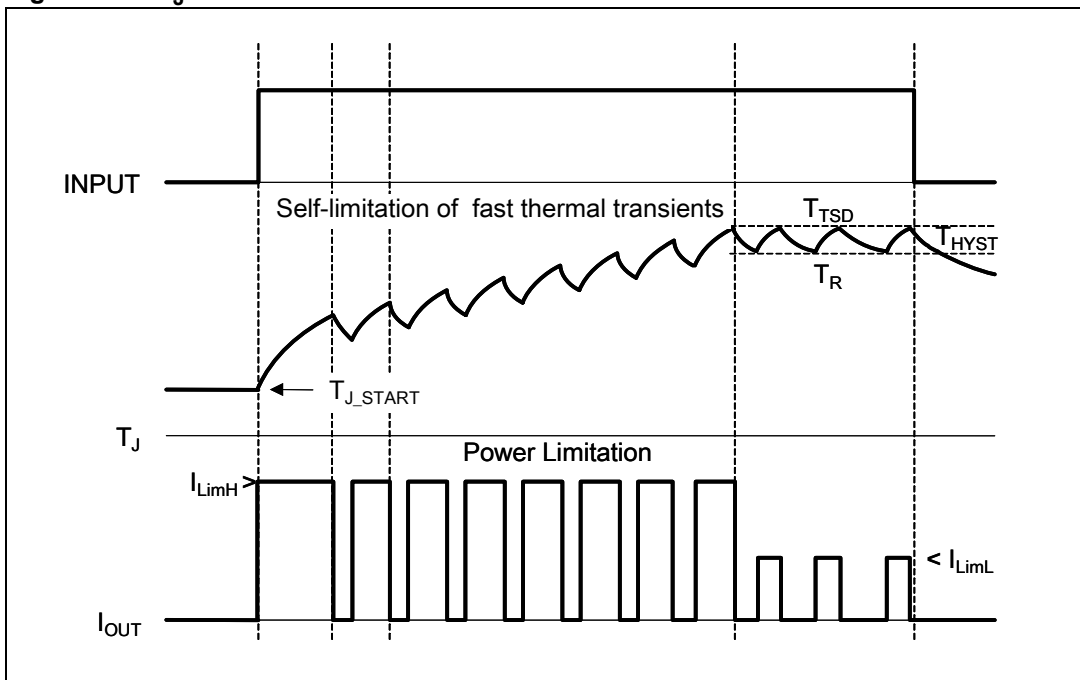

Figure 13. T_J evolution in overload or short to GND



2.5 Electrical characteristics curves

Figure 14. OFF-state output current

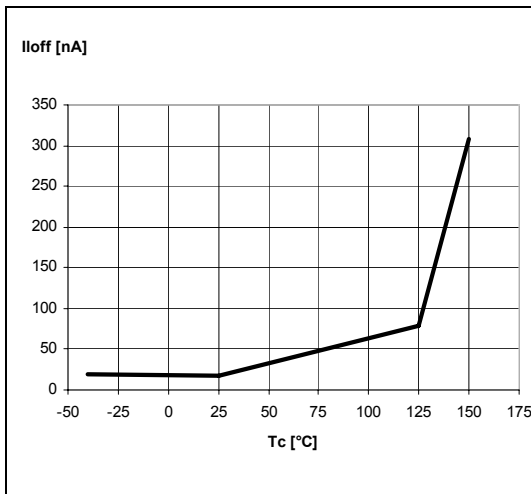

Figure 15. High-level input current

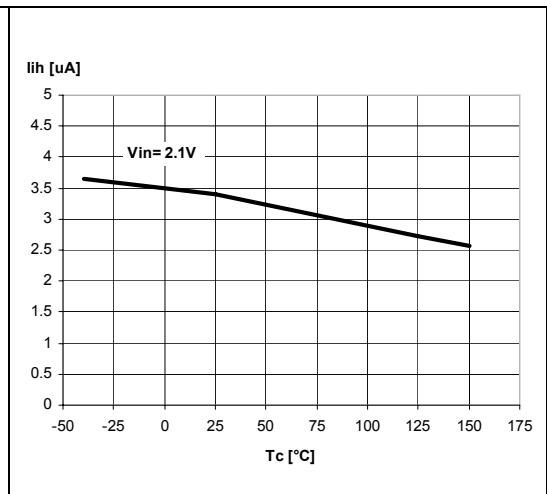

Figure 16. Input voltage clamp

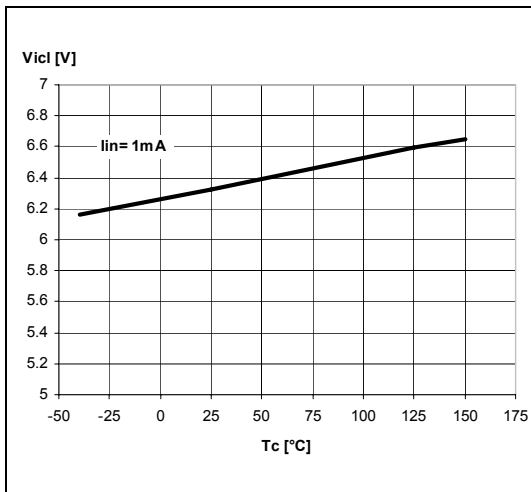

Figure 17. Low-level input voltage

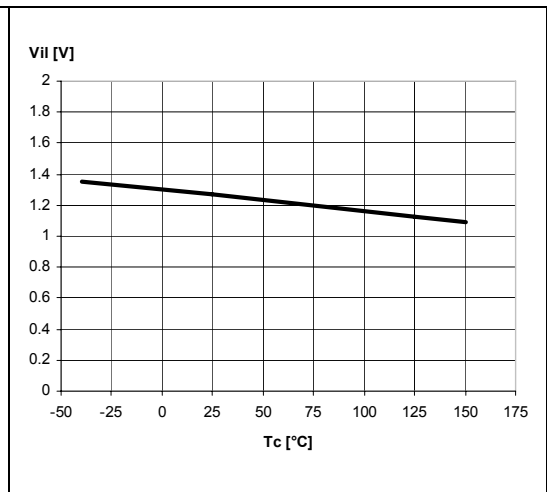

Figure 18. High-level input voltage

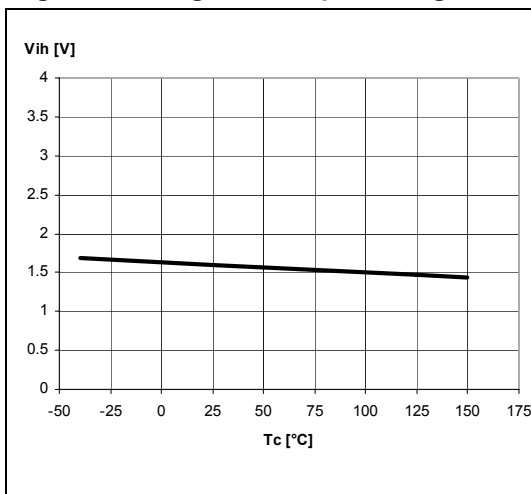

Figure 19. Hysteresis input voltage

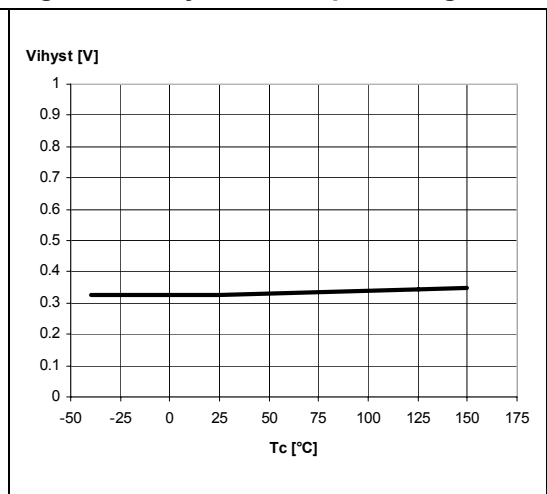

Figure 20. ON-state resistance vs. T_{case}

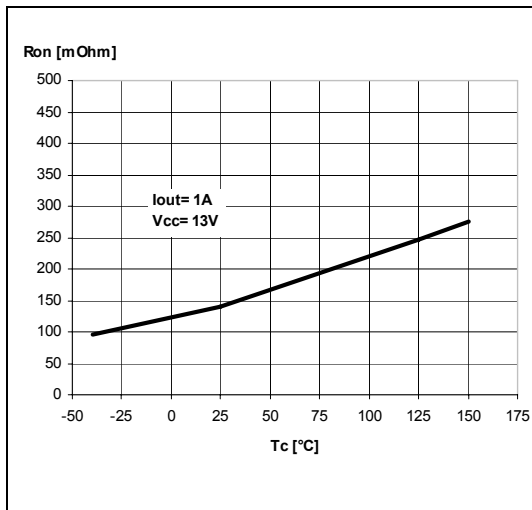

Figure 21. ON-state resistance vs. V_{CC}

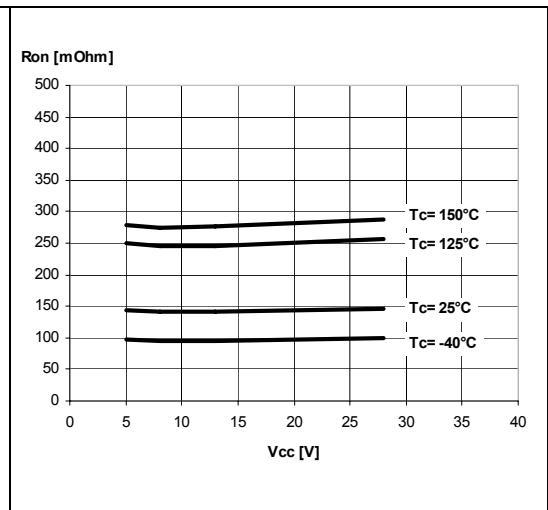

Figure 22. Undervoltage shutdown

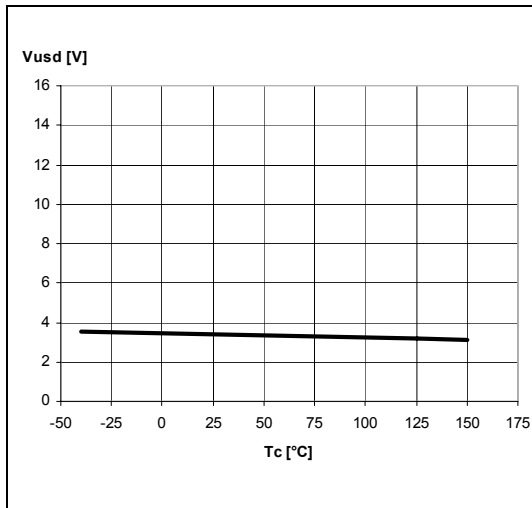

Figure 23. Turn-on voltage slope

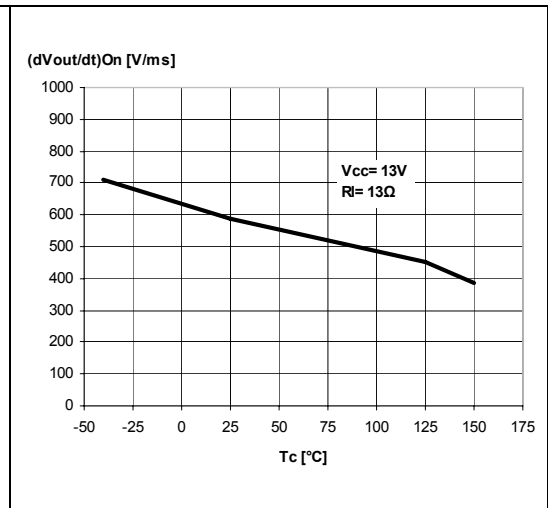

Figure 24. I_{LIMH} vs. T_{case}

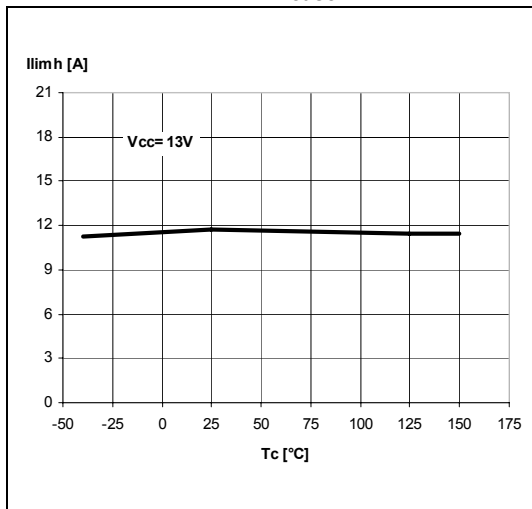

Figure 25. Turn-off voltage slope

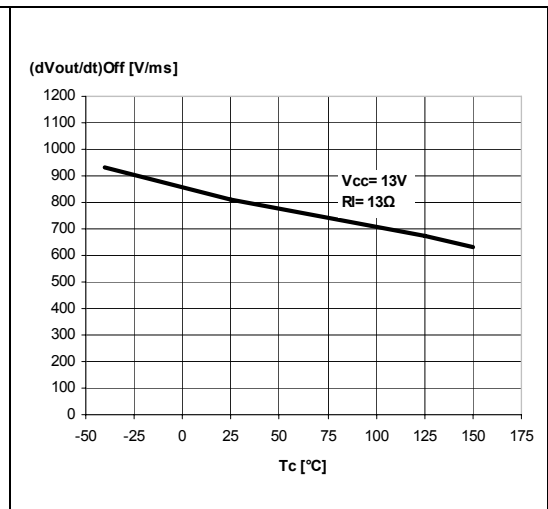

Figure 26. High-level CS_DIS voltage

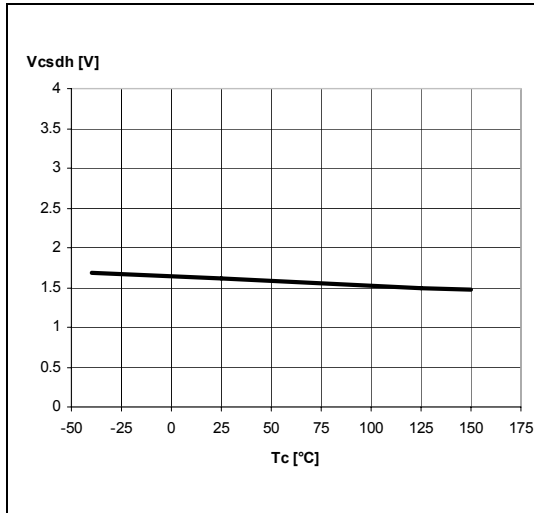

Figure 27. CS_DIS voltage clamp

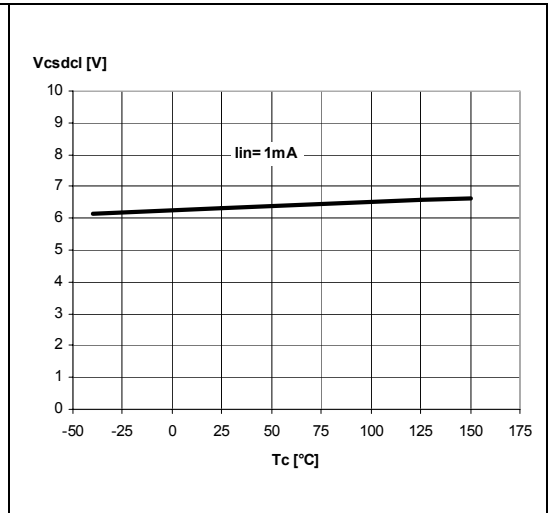
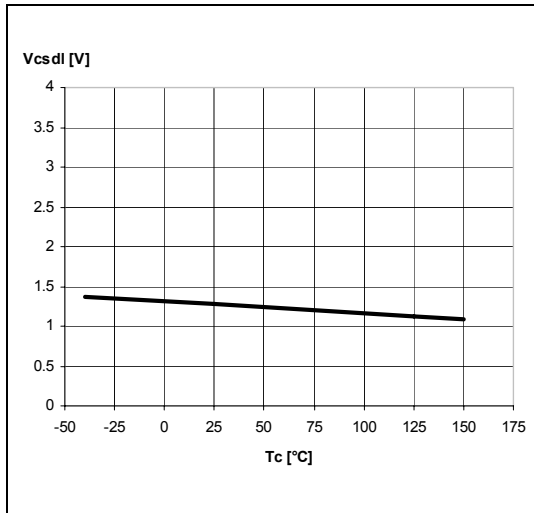
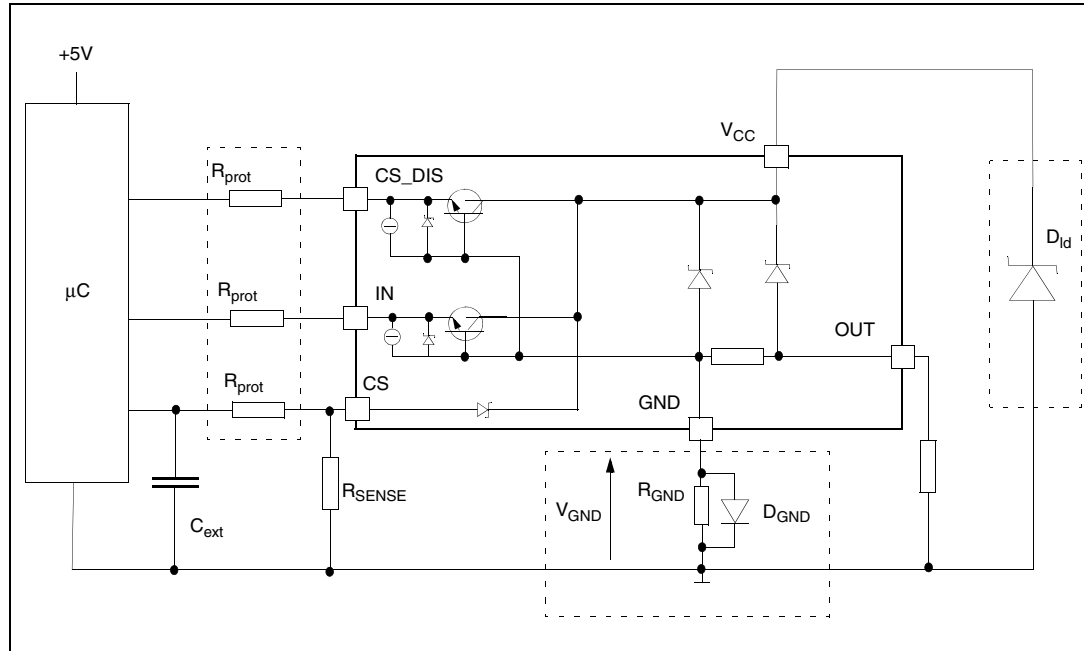

Figure 28. Low-level CS_DIS voltage



3 Application information

Figure 29. Application schematic



3.1 GND protection network against reverse battery

3.1.1 Solution 1: resistor in the ground line (R_{GND} only)

This can be used with any type of load.

The following is an indication on how to dimension the R_{GND} resistor.

1. $R_{GND} \leq 600 \text{ mV} / (I_{S(on)max})$.
2. $R_{GND} \geq (-V_{CC}) / (-I_{GND})$

where -I_{GND} is the DC reverse ground pin current and can be found in the absolute maximum rating section of the device datasheet.

Power dissipation in R_{GND} (when V_{CC} < 0: during reverse battery situations) is:

Equation 1

$$P_D = (-V_{CC})^2 / R_{GND}$$

This resistor can be shared amongst several different HSDs. Please note that the value of this resistor should be calculated with formula (1) where I_{S(on)max} becomes the sum of the maximum ON-state currents of the different devices.

Please note that if the microprocessor ground is not shared by the device ground then the R_{GND} produces a shift (I_{S(on)max} * R_{GND}) in the input thresholds and the status output

values. This shift varies depending on how many devices are ON in the case of several high-side drivers sharing the same R_{GND} .

If the calculated power dissipation leads to a large resistor or several devices have to share the same resistor then ST suggests to utilize Solution 2 (see [Section 3.1.2: Solution 2: a diode \(DGND\) in the ground line](#)).

3.1.2 Solution 2: a diode (D_{GND}) in the ground line

A resistor ($R_{GND} = 1 \text{ k}\Omega$) should be inserted in parallel to D_{GND} if the device drives an inductive load.

This small signal diode can be safely shared amongst several different HSDs. Also in this case, the presence of the ground network produces a shift ($\approx 600 \text{ mV}$) in the input threshold and in the status output values if the microprocessor ground is not common to the device ground. This shift not varies if more than one HSD shares the same diode/resistor network.

3.2 Load dump protection

D_{ld} is necessary (voltage transient suppressor) if the load dump peak voltage exceeds the V_{CC} max DC rating. The same applies if the device is subject to transients on the V_{CC} line that are greater than the ones shown in the ISO T/R 7637/1 table.

3.3 MCU I/Os protection

If a ground protection network is used and negative transients are present on the V_{CC} line, the control pins is pulled negative. ST suggests to insert a resistor (R_{prot}) in line to prevent the microcontroller I/Os pins to latch-up.

The value of these resistors is a compromise between the leakage current of microcontroller and the current required by the HSD I/Os (input levels compatibility) with the latch-up limit of microcontroller I/Os.

Equation 2

$$-V_{CCpeak} / I_{latchup} \leq R_{prot} \leq (V_{OH\mu C} - V_{IH} - V_{GND}) / I_{IHmax}$$

Calculation example:

For $V_{CCpeak} = -100 \text{ V}$, $I_{latchup} \geq 20 \text{ mA}$, $V_{OH\mu C} \geq 4.5 \text{ V}$

$$5 \text{ k}\Omega \leq R_{prot} \leq 180 \text{ k}\Omega.$$

Recommended values: $R_{prot} = 10 \text{ k}\Omega$, $C_{EXT} = 10 \text{ nF}$.

3.4 Current sense and diagnostic

The current sense pin performs a double function (see [Figure 30: Current sense and diagnostic](#)):

- **Current mirror of the load current in normal operation**, delivering a current proportional to the load one according to a know ratio K_x .
The current I_{SENSE} can be easily converted to a voltage V_{SENSE} by means of an external resistor R_{SENSE} . Linearity between I_{OUT} and V_{SENSE} is ensured up to 5 V minimum (see parameter V_{SENSE} in [Table 9: Current sense \(8 V < \$V_{CC}\$ < 18 V\)](#)). The current sense accuracy depends on the output current (refer to current sense electrical characteristics [Table 9: Current sense \(8 V < \$V_{CC}\$ < 18 V\)](#)).
- **Diagnostic flag in fault conditions**, delivering a fixed voltage V_{SENSEH} up to a maximum current I_{SENSEH} in case of the following fault conditions (refer to [Table 10: Truth table](#)):
 - Power limitation activation
 - Overtemperature

A logic high-level on CS_DIS pin sets at the same time all the current sense pins of the devices in a high-impedance-state, thus disabling the current monitoring and diagnostic detection. This feature allows multiplexing of the microcontroller analog inputs by sharing of sense resistance and ADC line among different devices.

Figure 30. Current sense and diagnostic

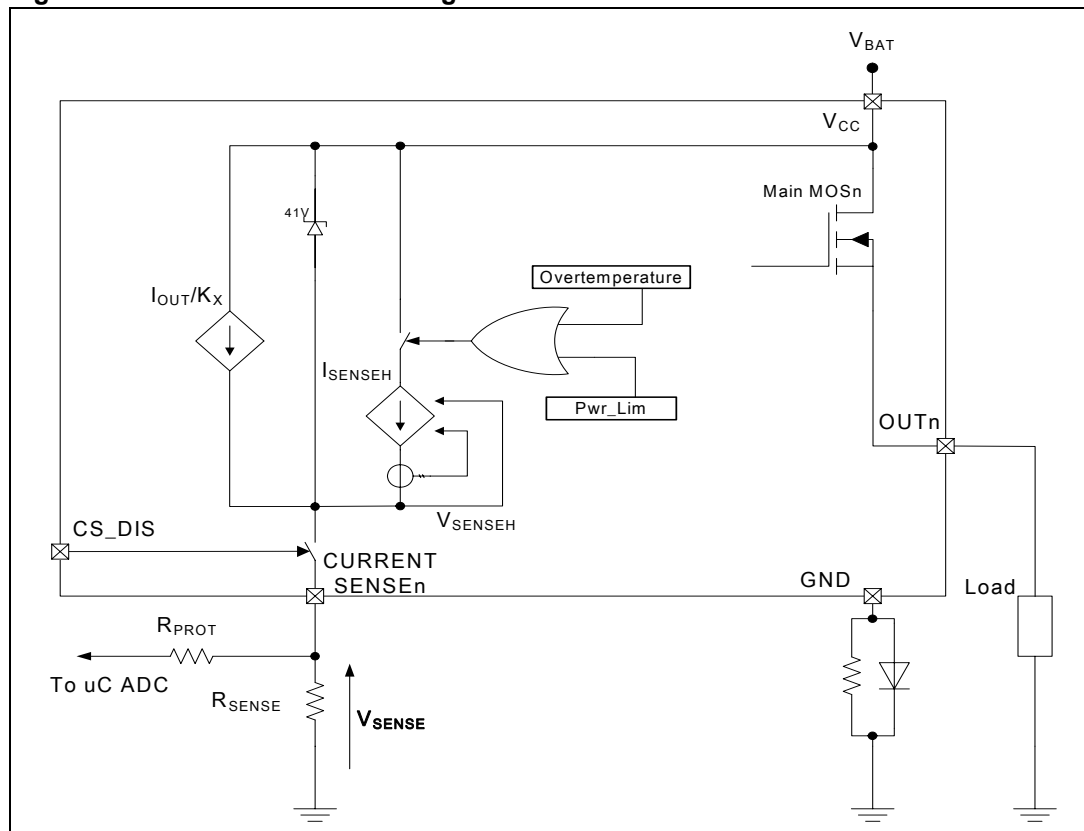

3.5 Maximum demagnetization energy ($V_{CC} = 13.5\text{ V}$)

Figure 31. Maximum turn-off current versus inductance (for each channel)⁽¹⁾

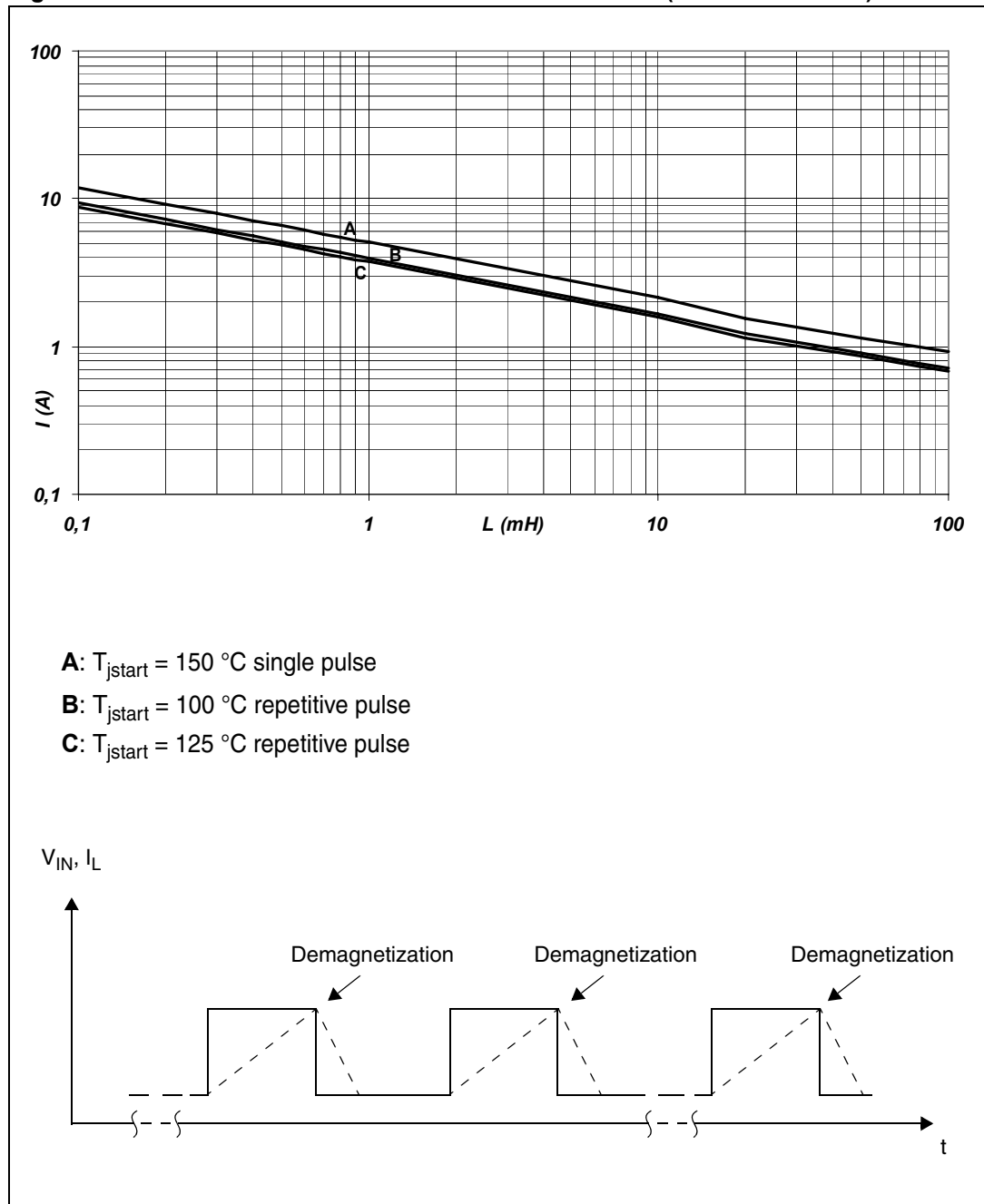

1. Values are generated with $R_L = 0\ \Omega$.

In case of repetitive pulses, T_{jstart} (at beginning of each demagnetization) of every pulse must not exceed the temperature specified above for curves A and B.

4 Package and PCB thermal data

4.1 SO-8 thermal data

Figure 32. SO-8 PC board⁽¹⁾

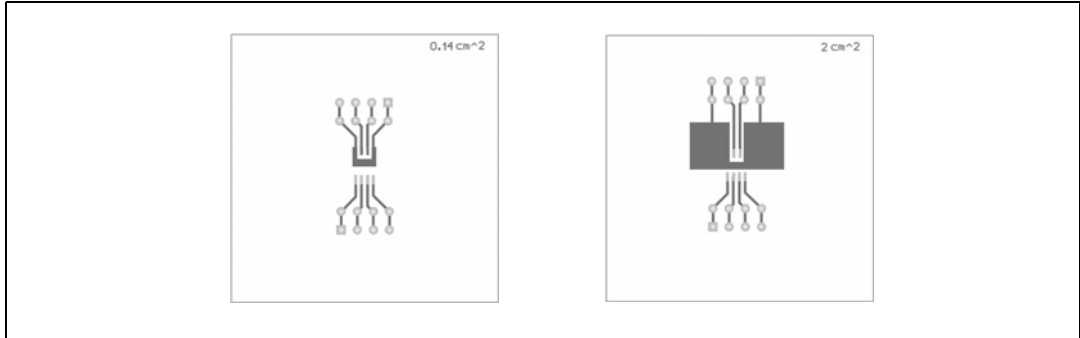

1. Layout condition of R_{th} and Z_{th} measurements (PCB: FR4 area = 4.8 mm x 4.8 mm, PCB thickness = 2 mm, Cu thickness = 35 μ m, Copper areas: from minimum pad lay-out to 2 cm²).

Figure 33. $R_{thj-amb}$ vs. PCB copper area in open box free air condition

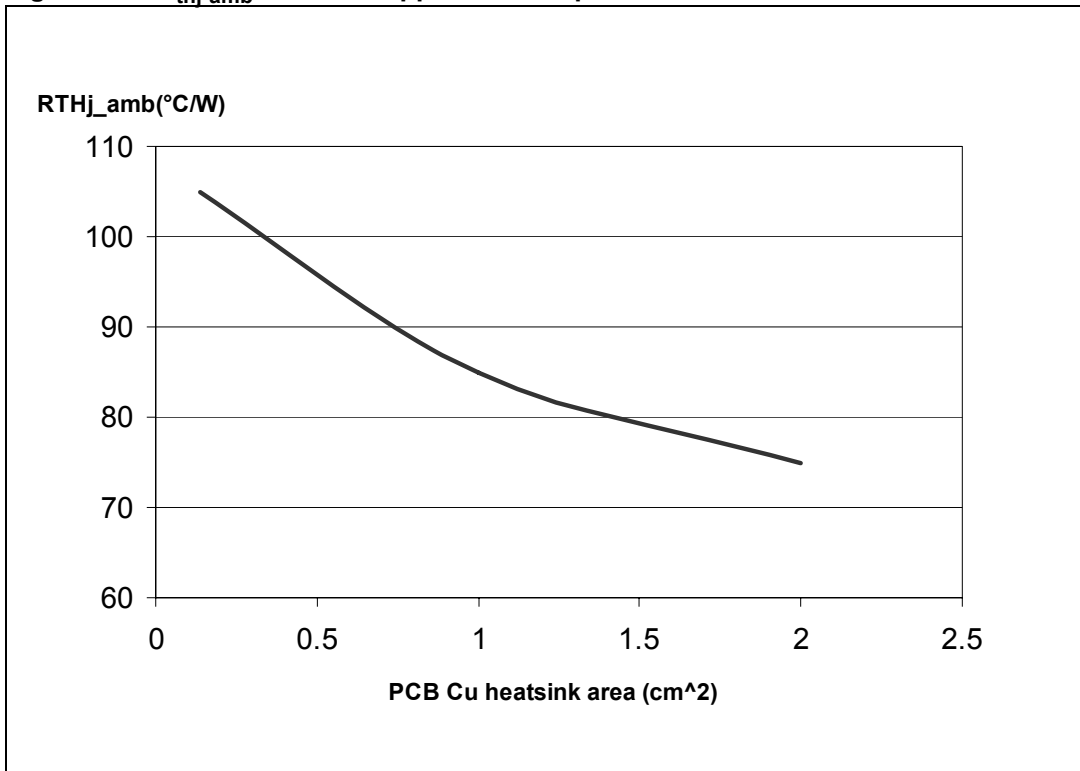
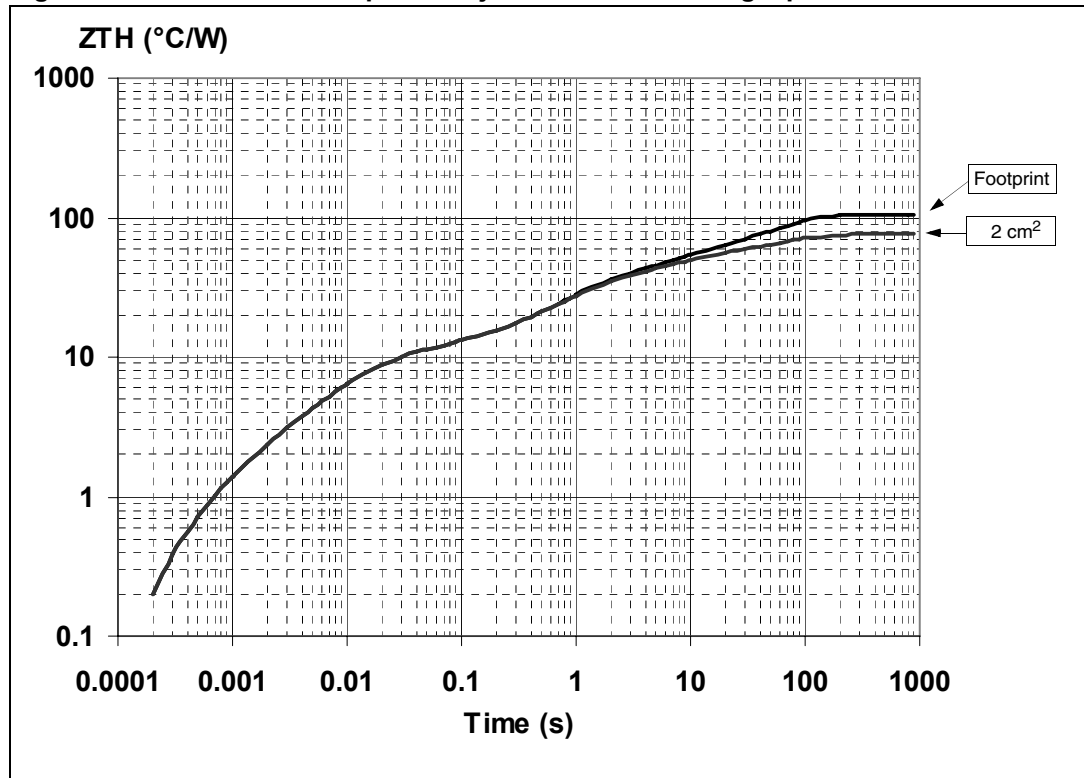

Figure 34. SO-8 thermal impedance junction ambient single pulse



Equation 3: pulse calculation formula

$$Z_{TH\delta} = R_{TH} \cdot \delta + Z_{THtp}(1 - \delta)$$

where $\delta = t_p/T$

Figure 35. Thermal fitting model of an HSD in SO-8⁽¹⁾

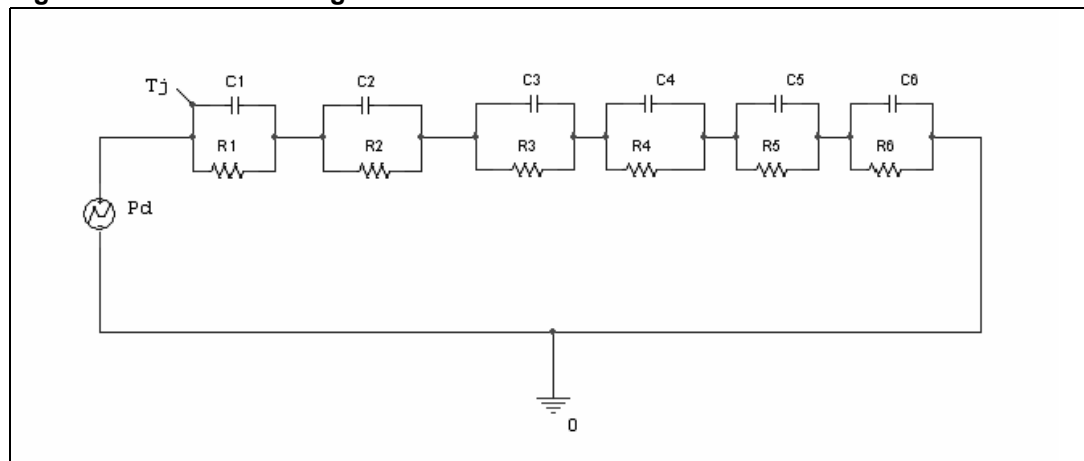

1. The fitting model is a simplified thermal tool and is valid for transient evolutions where the embedded protections (power limitation or thermal cycling during thermal shutdown) are not triggered.

Table 14. Thermal parameters

Area/island (cm ²)	Footprint	2
R1 (°C/W)	1.2	
R2 (°C/W)	6	
R3 (°C/W)	3.5	
R4 (°C/W)	21	
R5 (°C/W)	16	
R6 (°C/W)	58	28
C1 (W.s/°C)	0.0008	
C2 (W.s/°C)	0.0016	
C3 (W.s/°C)	0.0075	
C4 (W.s/°C)	0.045	
C5 (W.s/°C)	0.35	
C6 (W.s/°C)	1.05	25

5 Package and packing information

5.1 ECOPACK®

In order to meet environmental requirements, ST offers these devices in different grades of ECOPACK® packages, depending on their level of environmental compliance. ECOPACK® specifications, grade definitions and product status are available at: www.st.com. ECOPACK® is an ST trademark.

5.2 Package mechanical data

Figure 36. SO-8 package dimensions

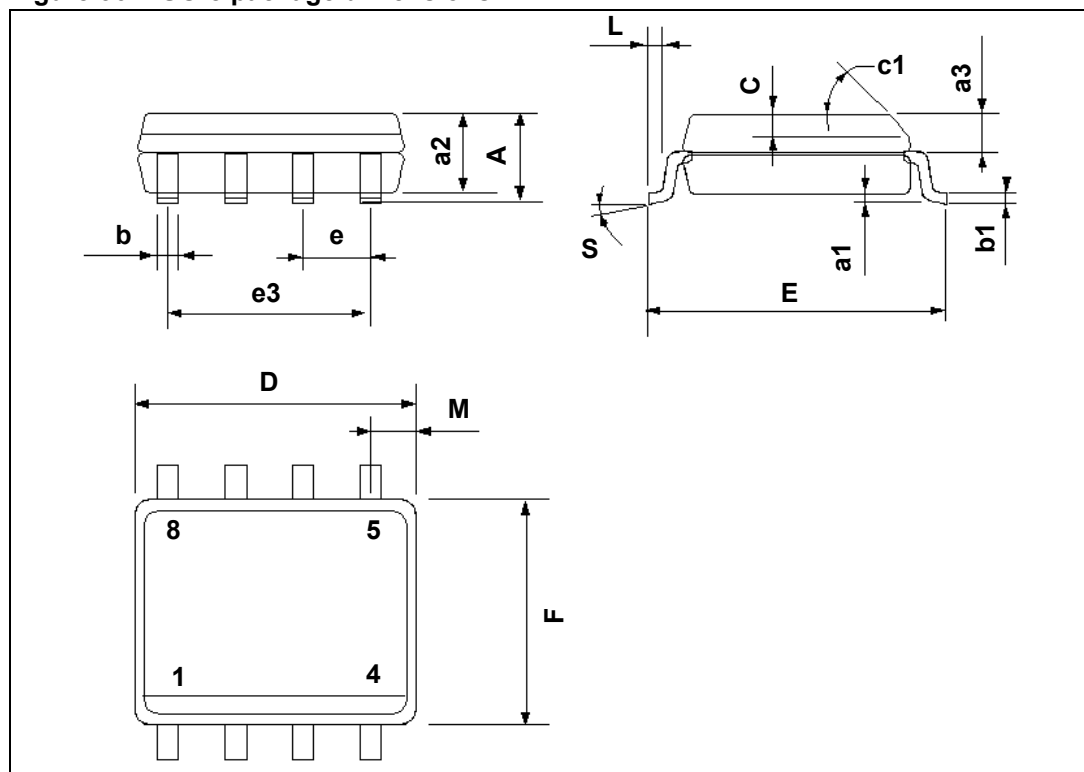

Table 15. SO-8 mechanical data

Dim.	mm.		
	Min.	Typ.	Max.
A			1.75
a1	0.1		0.25
a2			1.65
a3	0.65		0.85
b	0.35		0.48
b1	0.19		0.25
C	0.25		0.5
c1	45 (typ.)		
D	4.8		5
E	5.8		6.2
e		1.27	
e3		3.81	
F	3.8		4
L	0.4		1.27
M			0.6
S	8 (max.)		
L1	0.8		1.2

5.3 Packing information

Figure 37. SO-8 tube shipment (no suffix)

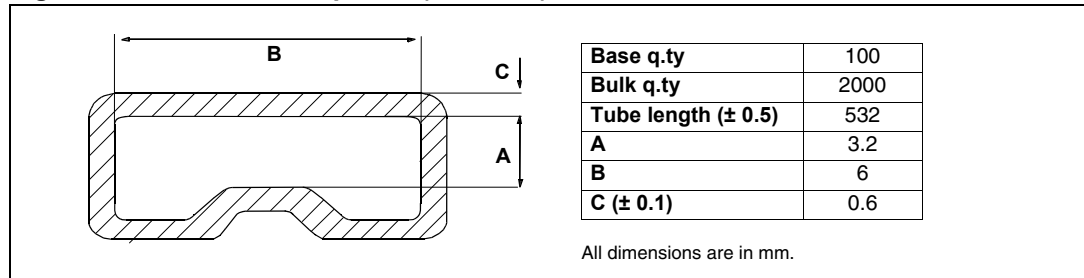
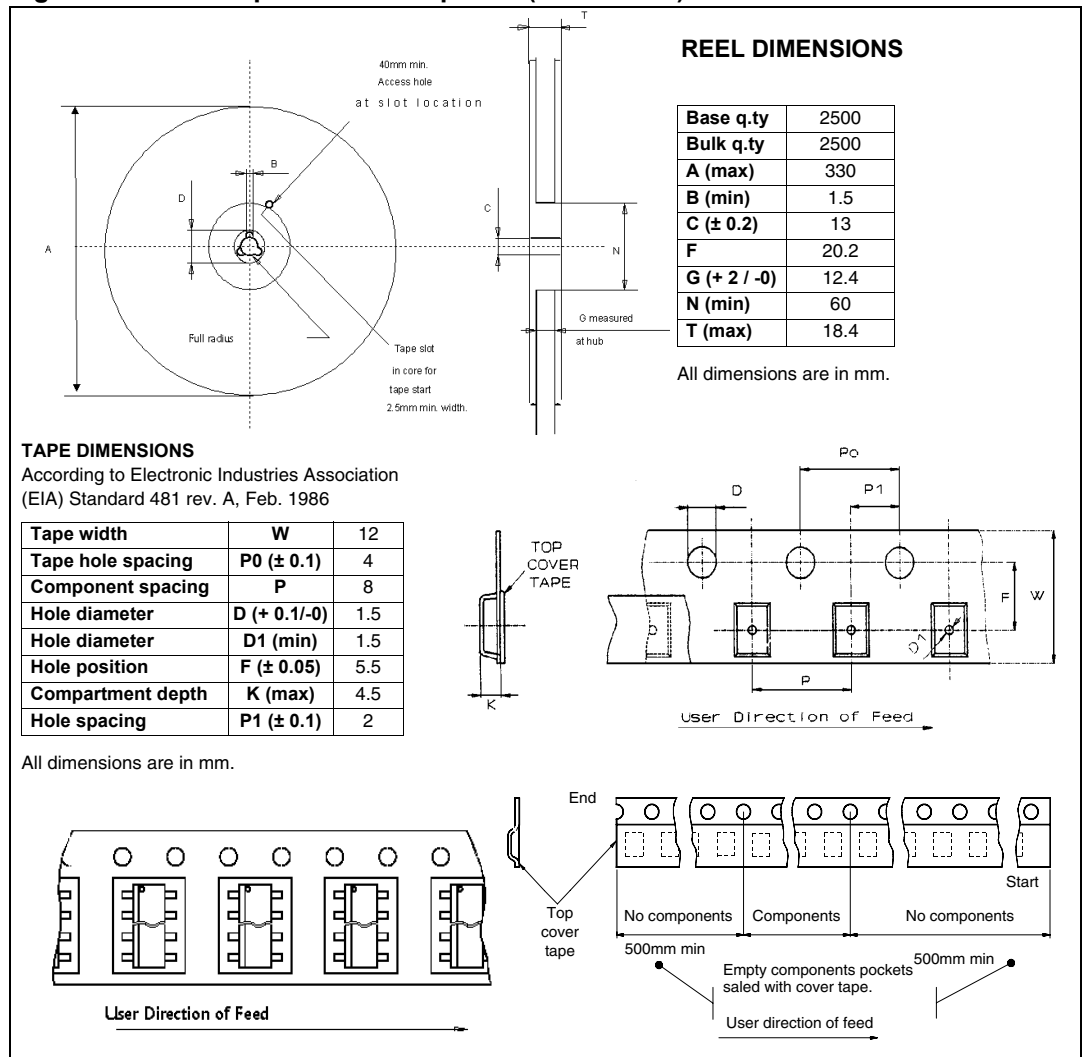

Figure 38. SO-8 tape and reel shipment (suffix “TR”)



6 Order codes

Table 16. Device summary

Package	Order codes	
	Tube	Tape and reel
SO-8	VN5E160MS-E	VN5E160MSTR-E

7 Revision history

Table 17. Document revision history

Date	Revision	Changes
10-Jun-2009	1	Initial release.
25-Jan-2010	2	Updated Table 9: Current sense (8 V < V_{CC} < 18 V) .

Please Read Carefully:

Information in this document is provided solely in connection with ST products. STMicroelectronics NV and its subsidiaries ("ST") reserve the right to make changes, corrections, modifications or improvements, to this document, and the products and services described herein at any time, without notice.

All ST products are sold pursuant to ST's terms and conditions of sale.

Purchasers are solely responsible for the choice, selection and use of the ST products and services described herein, and ST assumes no liability whatsoever relating to the choice, selection or use of the ST products and services described herein.

No license, express or implied, by estoppel or otherwise, to any intellectual property rights is granted under this document. If any part of this document refers to any third party products or services it shall not be deemed a license grant by ST for the use of such third party products or services, or any intellectual property contained therein or considered as a warranty covering the use in any manner whatsoever of such third party products or services or any intellectual property contained therein.

UNLESS OTHERWISE SET FORTH IN ST'S TERMS AND CONDITIONS OF SALE ST DISCLAIMS ANY EXPRESS OR IMPLIED WARRANTY WITH RESPECT TO THE USE AND/OR SALE OF ST PRODUCTS INCLUDING WITHOUT LIMITATION IMPLIED WARRANTIES OF MERCHANTABILITY, FITNESS FOR A PARTICULAR PURPOSE (AND THEIR EQUIVALENTS UNDER THE LAWS OF ANY JURISDICTION), OR INFRINGEMENT OF ANY PATENT, COPYRIGHT OR OTHER INTELLECTUAL PROPERTY RIGHT.

UNLESS EXPRESSLY APPROVED IN WRITING BY AN AUTHORIZED ST REPRESENTATIVE, ST PRODUCTS ARE NOT RECOMMENDED, AUTHORIZED OR WARRANTED FOR USE IN MILITARY, AIR CRAFT, SPACE, LIFE SAVING, OR LIFE SUSTAINING APPLICATIONS, NOR IN PRODUCTS OR SYSTEMS WHERE FAILURE OR MALFUNCTION MAY RESULT IN PERSONAL INJURY, DEATH, OR SEVERE PROPERTY OR ENVIRONMENTAL DAMAGE. ST PRODUCTS WHICH ARE NOT SPECIFIED AS "AUTOMOTIVE GRADE" MAY ONLY BE USED IN AUTOMOTIVE APPLICATIONS AT USER'S OWN RISK.

Resale of ST products with provisions different from the statements and/or technical features set forth in this document shall immediately void any warranty granted by ST for the ST product or service described herein and shall not create or extend in any manner whatsoever, any liability of ST.

ST and the ST logo are trademarks or registered trademarks of ST in various countries.

Information in this document supersedes and replaces all information previously supplied.

The ST logo is a registered trademark of STMicroelectronics. All other names are the property of their respective owners.

© 2010 STMicroelectronics - All rights reserved

STMicroelectronics group of companies

Australia - Belgium - Brazil - Canada - China - Czech Republic - Finland - France - Germany - Hong Kong - India - Israel - Italy - Japan - Malaysia - Malta - Morocco - Philippines - Singapore - Spain - Sweden - Switzerland - United Kingdom - United States of America

www.st.com

