

## Symbol LED, 2.5 x 5 mm Flat Tinted Top-Diffused Package

Color	Type	Technology	Angle of Half Intensity $\pm\phi$
Red	TL5H510.	GaAsP on GaP	50°
Yellow	TL5Y510.	GaAsP on GaP	
Green	TL5G510.	GaP on GaP	

### Description

This series was developed for use as compact surface display. It is housed in a 2.5 x 5 mm rectangular molded package. This device has a flat tinted, top-diffused package for uniform brightness when used in panels.

The symbol LEDs are available in three bright colors: high-efficiency red, yellow and green.

### Features

- Choice of three bright colors
- Uniform illumination
- Luminous intensity selected into groups
- Suitable for DC and pulse operation
- Flat light emitting surface
- Direct symbol indication is possible
- Yellow and green color categorized
- Wide viewing angle

### Applications

Status lights  
Background illumination  
Maintenance lights  
Indicator of audio and visual equipment  
Off / On indicator  
Readout lights  
Legend lights  
Illumination of moving boards

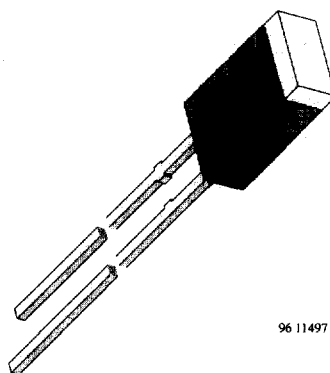

96 11497

### Absolute Maximum Ratings

$T_{amb} = 25^{\circ}\text{C}$ , unless otherwise specified

**TLSH510. , TLSY510. , TLSG510.**

Parameter	Test Conditions	Type	Symbol	Value	Unit
Reverse voltage			$V_R$	6	V
DC forward current			$I_F$	30	mA
Surge forward current	$t_p \leq 10 \mu\text{s}$		$I_{FSM}$	1	A
Power dissipation	$T_{amb} \leq 65^{\circ}\text{C}$		$P_V$	100	mW
Junction temperature			$T_j$	100	$^{\circ}\text{C}$
Storage temperature range			$T_{stg}$	-55 to +100	$^{\circ}\text{C}$
Soldering temperature	$t \leq 5 \text{ s}$ , 2 mm from body		$T_{sd}$	260	$^{\circ}\text{C}$
Thermal resistance junction/ambient			$R_{thJA}$	350	K/W

### Optical and Electrical Characteristics

$T_{amb} = 25^{\circ}\text{C}$ , unless otherwise specified

**Red (TLSH510.)**

Parameter	Test Conditions	Type	Symbol	Min	Typ	Max	Unit
Luminous intensity	$I_F = 10 \text{ mA}$ , $I_{Vmin}/I_{Vmax} \geq 0.5$	TLSH5100	$I_V$	0.63	1.5		mcd
		TLSH5101	$I_V$	1	2		mcd
Dominant wavelength	$I_F = 10 \text{ mA}$		$\lambda_d$		640		nm
Peak wavelength	$I_F = 10 \text{ mA}$		$\lambda_p$		650		nm
Angle of half intensity	$I_F = 10 \text{ mA}$		$\phi$		$\pm 50$		deg
Forward voltage	$I_F = 20 \text{ mA}$		$V_F$		2	3	V
Reverse voltage	$I_R = 10 \mu\text{A}$		$V_R$	6	15		V
Junction capacitance	$V_R = 0$ , $f = 1 \text{ MHz}$		$C_j$		50		pF

**Yellow (TLSY510.)**

Parameter	Test Conditions	Type	Symbol	Min	Typ	Max	Unit
Luminous intensity	$I_F = 10 \text{ mA}$ , $I_{Vmin}/I_{Vmax} \geq 0.5$	TLSY5100	$I_V$	0.4	1		mcd
		TLSY5101	$I_V$	1	3		mcd
Dominant wavelength	$I_F = 10 \text{ mA}$		$\lambda_d$	581		594	nm
Peak wavelength	$I_F = 10 \text{ mA}$		$\lambda_p$		585		nm
Angle of half intensity	$I_F = 10 \text{ mA}$		$\phi$		$\pm 50$		deg
Forward voltage	$I_F = 20 \text{ mA}$		$V_F$		2.4	3	V
Reverse voltage	$I_R = 10 \mu\text{A}$		$V_R$	6	15		V
Junction capacitance	$V_R = 0$ , $f = 1 \text{ MHz}$		$C_j$		50		pF

**Green (TLSG510.)**

Parameter	Test Conditions	Type	Symbol	Min	Typ	Max	Unit
Luminous intensity	$I_F = 10 \text{ mA}$ , $I_{V_{\min}}/I_{V_{\max}} \geq 0.5$	TLSG5100	$I_V$	0.4	1		mcd
		TLSG5101	$I_V$	1	2		mcd
Dominant wavelength	$I_F = 10 \text{ mA}$		$\lambda_d$	562		575	nm
Peak wavelength	$I_F = 10 \text{ mA}$		$\lambda_p$		565		nm
Angle of half intensity	$I_F = 10 \text{ mA}$		$\varphi$		$\pm 50$		deg
Forward voltage	$I_F = 20 \text{ mA}$		$V_F$		2.4	3	V
Reverse voltage	$I_R = 10 \mu\text{A}$		$V_R$	6	15		V
Junction capacitance	$V_R = 0$ , $f = 1 \text{ MHz}$		$C_j$		50		pF

**Typical Characteristics ( $T_{\text{amb}} = 25^\circ\text{C}$ , unless otherwise specified)**

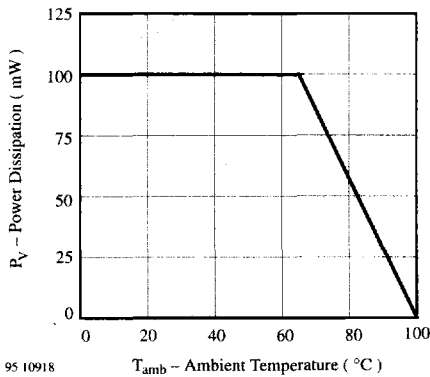

Figure 1. Power Dissipation vs. Ambient Temperature

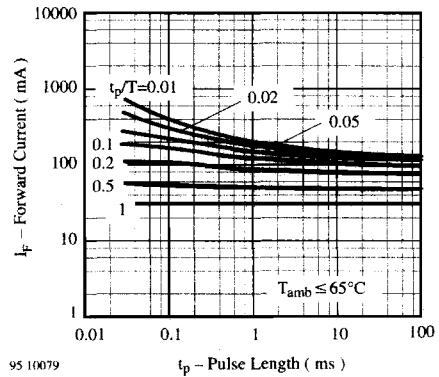

Figure 3. Forward Current vs. Pulse Length

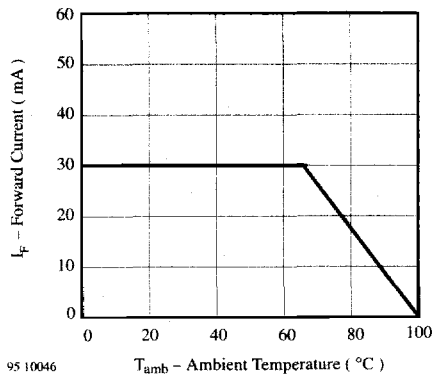

Figure 2. Forward Current vs. Ambient Temperature

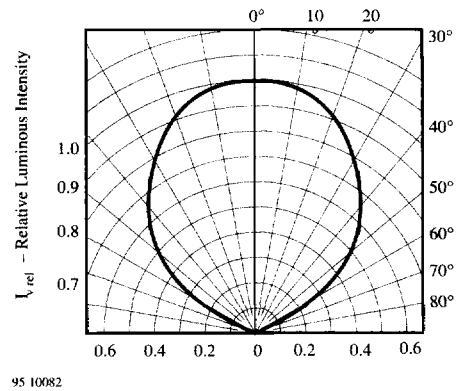
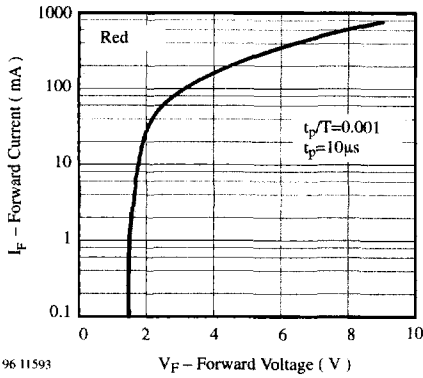
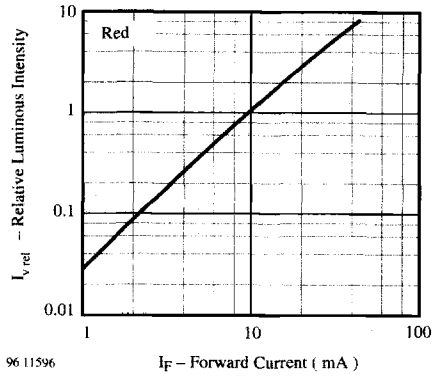

Figure 4. Rel. Luminous Intensity vs. Angular Displacement



96 11593

Figure 5. Forward Current vs. Forward Voltage



96 11596

Figure 8. Relative Luminous Intensity vs. Forward Current

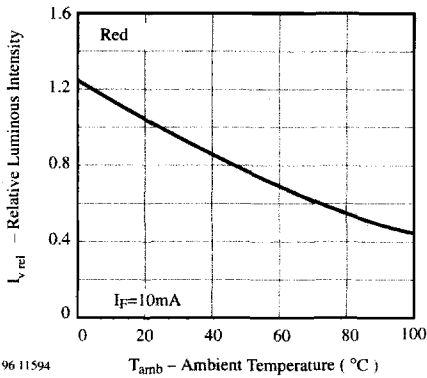

96 11594

Figure 6. Rel. Luminous Intensity vs. Ambient Temperature

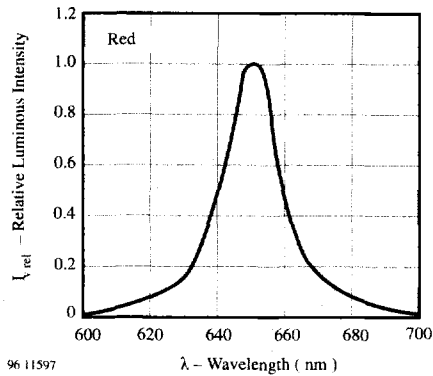

96 11597

Figure 9. Relative Luminous Intensity vs. Wavelength

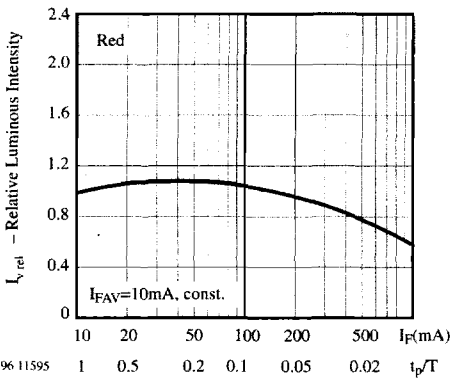

96 11595

Figure 7. Rel. Lumin. Intensity vs. Forw. Current/Duty Cycle

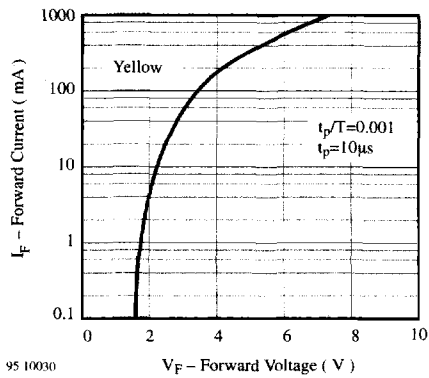

95 10030

Figure 10. Forward Current vs. Forward Voltage

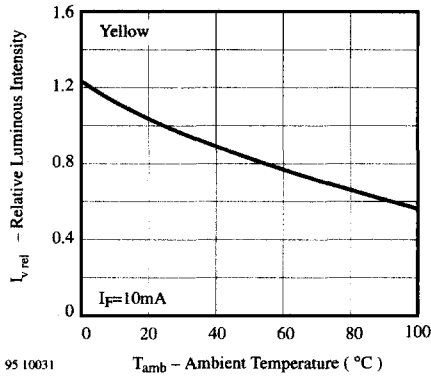

Figure 11. Rel. Luminous Intensity vs. Ambient Temperature

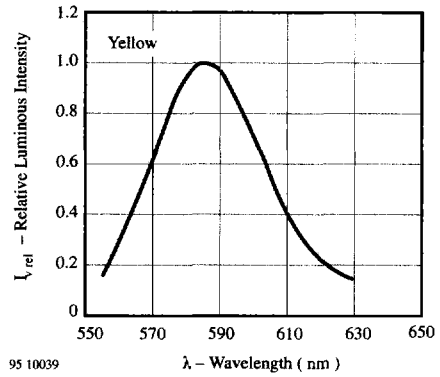

Figure 14. Relative Luminous Intensity vs. Wavelength

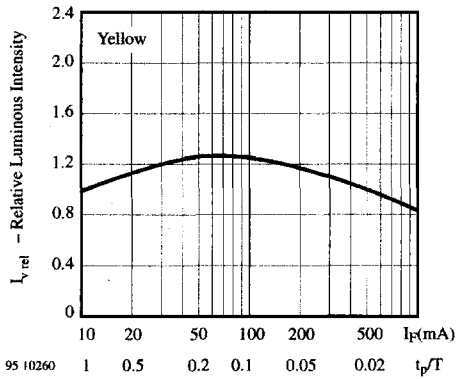

Figure 12. Rel. Lumin. Intensity vs. Forw. Current/Duty Cycle

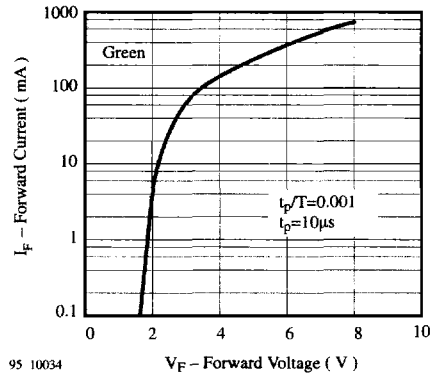

Figure 15. Forward Current vs. Forward Voltage

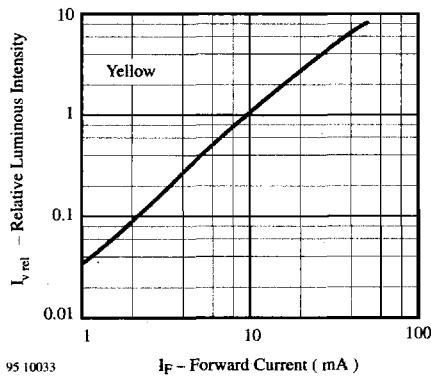

Figure 13. Relative Luminous Intensity vs. Forward Current

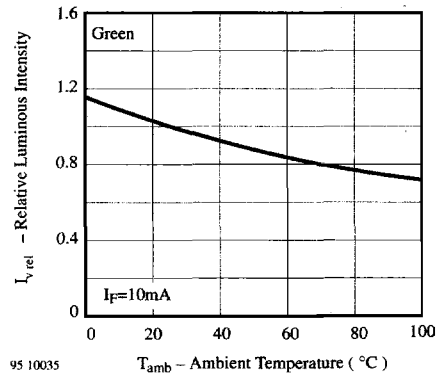

Figure 16. Rel. Luminous Intensity vs. Ambient Temperature

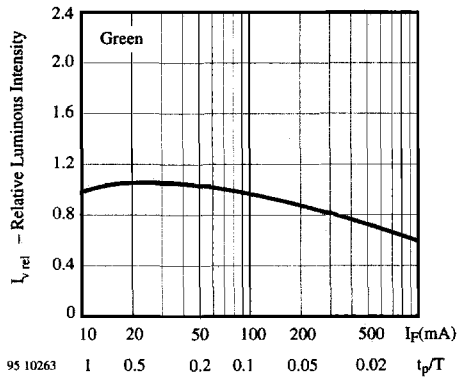

Figure 17. Rel. Lumin. Intensity vs. Forw. Current/Duty Cycle

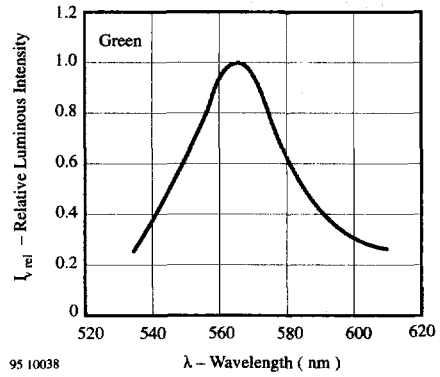

Figure 19. Relative Luminous Intensity vs. Wavelength

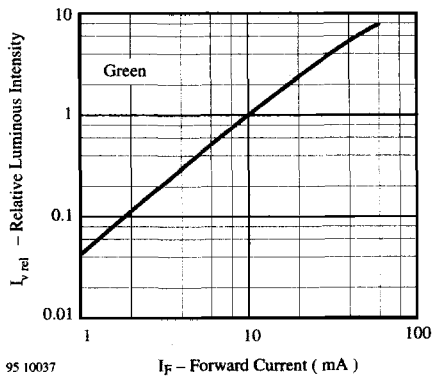

Figure 18. Relative Luminous Intensity vs. Forward Current

## Dimensions in mm

95 11326

