

NLC Series

For High Current Application

Wound Chip Inductors

These revolutionary, highly reliable wound chip inductors for automatic mounting have been developed in response to the trend toward high density in electronic equipment.

With metal terminals and a body of heat resistant resin, these inductors offer many superior features.

APPLICATIONS

DC/DC converter such as DSC, LCD TV, game console, portable VCRs, conveyable telephone, and others.

FEATURES

Very strong solderability by reflow soldering and soldering iron

Highly accurate dimensions can be mounted automatically

Terminals are highly resistant to pull forces.

Highly resistant to mechanical shocks and pressure.

Highly reliable in environments of sudden temperature change and humidity.

Superior IDC for DC/DC converter.

SHAPES AND DIMENSIONS

Dimensions : mm

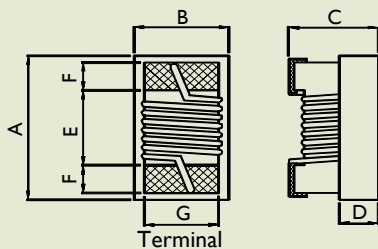

TYPE	A	B	C	D	E	F	G
NLC252018	2.92 ⁺⁰	2.79 ⁺⁰	2.20 ⁺⁰	0.70Ref	1.52	0.51	2.03
NLC252018	3.70 ⁺⁰	2.90 ⁺⁰	2.60 ⁺⁰	0.90Ref	2.18	0.51	2.40

PRODUCT IDENTIFICATION

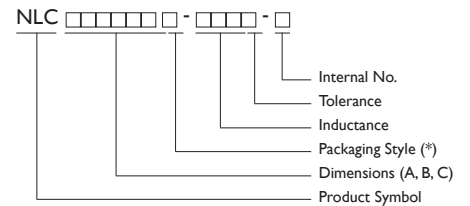

■ Packaging : T :Tape and Reel

■ Tolerance : J=±5% ; K= ±10%

■ YAGEO will start to release lead-free that meet SONY SS-00259's criteria, and Internal No. will be changed to "N" as identification.

Ex. NLC252018T-IR0K-N

RECOMMENDED PATTERN

Dimensions : mm

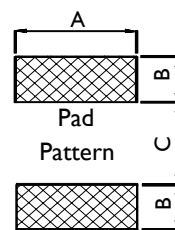

TYPE	A	B	C
NLC252018	2.54	1.02	1.27
NLC322522	2.70	1.00	2.00



ELECTRICAL CHARACTERISTICS

PART NO.	INDUCTANCE (μ H)	TOLERANCE (\pm %)	Q Min.	TEST FREQUENCY (MHz)	SRF (MHz) Min.	DC RESISTANCE (Ω) Max.	IDC (mA) Max.	COLOR CODING		
								1 ST	2 ND	3 RD
NLC252018T-1R0 □-S	1.0	10 / 5	25	7.96	300	0.34	1500	Brown	Black	Red
NLC252018T-1R5 □-S	1.5	10 / 5	25	7.96	270	0.42	1400	Brown	Green	Red
NLC252018T-2R2 □-S	2.2	10 / 5	25	7.96	140	0.50	1200	Red	Red	Red
NLC252018T-3R3 □-S	3.3	10 / 5	25	7.96	95	0.65	1000	Orange	Orange	Red
NLC252018T-4R7 □-S	4.7	10 / 5	25	7.96	90	0.80	800	Yellow	Violet	Red
NLC252018T-6R8 □-S	6.8	10 / 5	25	7.96	68	1.00	730	Blue	Gray	Red
NLC252018T-100 □-S	10	10 / 5	20	2.52	45	1.50	700	Brown	Black	Orange
NLC252018T-150 □-S	15	10 / 5	20	2.52	40	2.20	500	Brown	Green	Orange
NLC252018T-220 □-S	22	10 / 5	20	2.52	25	2.70	470	Red	Red	Orange
NLC252018T-330 □-S	33	10 / 5	20	2.52	25	4.00	400	Orange	Orange	Orange
NLC252018T-470 □-S	47	10 / 5	16	2.52	20	8.00	300	Yellow	Violet	Orange

• When ordering, please specify tolerance and packaging code.

Ex : NLC252018T-4R7J-S

• Tolerance : J = \pm 5% ; K = \pm 10%

• Packaging : Clear Tape and Reel (Standard)

• L / Q : Agilent / HP4291 + Agilent / HP16193A

• SRF : Agilent / HP4291A

• RDC : Digital Multimeter CH502BC HP4338B

• Idc for inductance drop 10% from its value without current.

• Operating Temperature Range : -25°C to 85°C

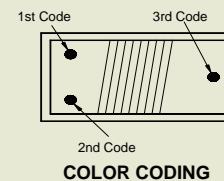

TEST INSTRUMENTS : HP4291A Impedance / Material Analyzer

Typical L vs. Frequency

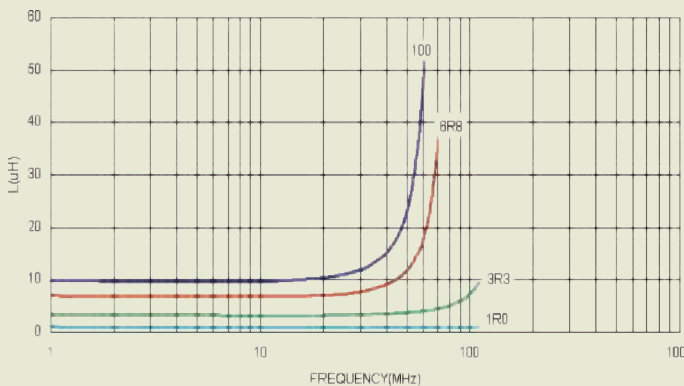

Typical Q vs. Frequency

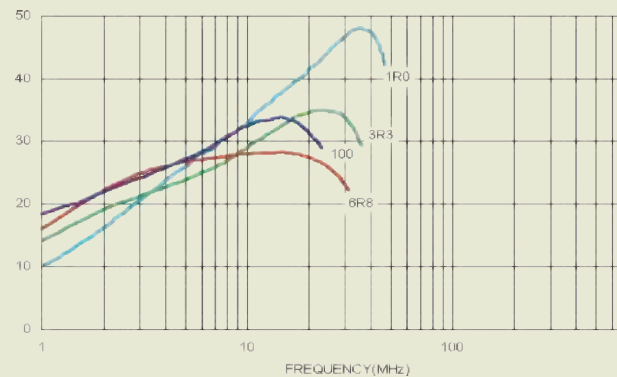



ELECTRICAL CHARACTERISTICS : LEAD-FREE & ROHS COMPLIANCE

PART NO.	INDUCTANCE (μ H)	TEST FREQ (MHZ)	Q Min.	SRF (MHz) Min.	RDC (Ω) Max.	IDC (mA) Max.	TOLERANCE (\pm %)	Color Code		
								1 ST	2 ND	3 RD
NLC252018T-1R0 \square -N	1	7.96	25	300	0.34	1500	5,10	BRN	BLK	RED
NLC252018T-1R5 \square -N	1.5	7.96	25	270	0.42	1400	5,10	BRN	GRN	RED
NLC252018T-2R2 \square -N	2.2	7.96	25	140	0.5	1200	5,10	RED	RED	RED
NLC252018T-3R3 \square -N	3.3	7.96	25	95	0.65	1000	5,10	ORN	ORN	RED
NLC252018T-4R7 \square -N	4.7	7.96	25	90	0.8	800	5,10	YEL	VIO	RED
NLC252018T-6R8 \square -N	6.8	7.96	25	68	1	730	5,10	BLU	GRY	RED
NLC252018T-100 \square -N	10	2.52	20	45	1.5	700	5,10	BRN	BLK	ORN
NLC252018T-150 \square -N	15	2.52	20	40	2.2	500	5,10	BRN	GRN	ORN
NLC252018T-220 \square -N	22	2.52	20	25	2.7	470	5,10	RED	RED	ORN
NLC252018T-330 \square -N	33	2.52	20	25	4	400	5,10	ORN	ORN	ORN
NLC252018T-470 \square -N	47	2.52	16	20	8	300	5,10	YEL	VIO	ORN

NOTE: \square -tolerance J= \pm 5% / K= \pm 10% / M= \pm 20%

1. Operating temperature range -25°C~85°C

2. IDC: Applied the current to coils, the inductance shall be less than 10% initial value.

"-N" FOR COMPLETELY LEAD FREE TYPE(INCLUDING FERRITE BODY & SOLDER)



ELECTRICAL CHARACTERISTICS

PART NO.	INDUCTANCE (μ H)	TOLERANCE (\pm %)	Q Min.	TEST FREQUENCY (MHz)	SRF (MHz) Min.	DC RESISTANCE (Ω) Max.	IDC (mA) Max.	COLOR CODING		
								1 ST	2 ND	3 RD
NLC322522T-1R0 □-S	1.0	5, 10	20	7.96	100	0.08	1500	Brown	Black	Red
NLC322522T-1R5 □-S	1.5	5, 10	20	7.96	80	0.13	1125	Brown	Green	Red
NLC322522T-2R2 □-S	2.2	5, 10	20	7.96	68	0.13	970	Red	Red	Red
NLC322522T-3R3 □-S	3.3	5, 10	20	7.96	54	0.16	837	Orange	Orange	Red
NLC322522T-4R7 □-S	4.7	5, 10	20	7.96	43	0.20	675	Yellow	Violet	Red
NLC322522T-6R8 □-S	6.8	5, 10	20	7.96	33	0.27	600	Blue	Gray	Red
NLC322522T-100 □-S	10	5, 10	15	2.52	28	0.36	520	Brown	Black	Orange
NLC322522T-150 □-S	15	5, 10	15	2.52	19	0.56	480	Brown	Green	Orange
NLC322522T-220 □-S	22	5, 10	15	2.52	16	0.77	310	Red	Red	Orange
NLC322522T-330 □-S	33	5, 10	15	2.52	12	1.10	270	Orange	Orange	Orange
NLC322522T-470 □-S	47	5, 10	15	2.52	10	1.64	210	Yellow	Violet	Orange
NLC322522T-680 □-S	68	5, 10	15	2.52	9	2.80	189	Blue	Gray	Orange
NLC322522T-101 □-S	100	5, 10	15	0.796	6	3.70	145	Brown	Black	Yellow
NLC322522T-151 □-S	150	5, 10	15	0.796	5	6.10	120	Brown	Green	Yellow
NLC322522T-221 □-S	220	5, 10	15	0.796	4	8.40	100	Red	Red	Yellow
NLC322522T-331 □-S	330	5, 10	15	0.796	3.5	12.3	80	Orange	Orange	Yellow
NLC322522T-471 □-S	470	5, 10	15	0.796	2.8	22.0	75	Yellow	Violet	Yellow
NLC322522T-681 □-S	680	5, 10	15	0.796	2	28.0	65	Blue	Gray	Yellow

• When ordering, please specify tolerance and packaging code.

Ex : NLC322522T-4R7J-S

• Tolerance : J = \pm 5% ; K = \pm 10%

• Packaging : Clear Tape and Reel (Standard)

• L / Q : Agilent / HP4291A + Agilent / HP16193A(over 1MHz)

Agilent / HP4285A + Agilent / HP16193A(under 1MHz)

• SRF : Agilent / HP4291A

• RDC : Digital Multimeter HP4338B CH502BC

• Idc for inductance drop 10% from its value without current.

• Operating Temperature Range : -25°C to 85°C

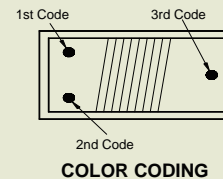

TEST INSTRUMENTS : HP4291A Impedance / Material Analyzer

Typical L vs. Frequency

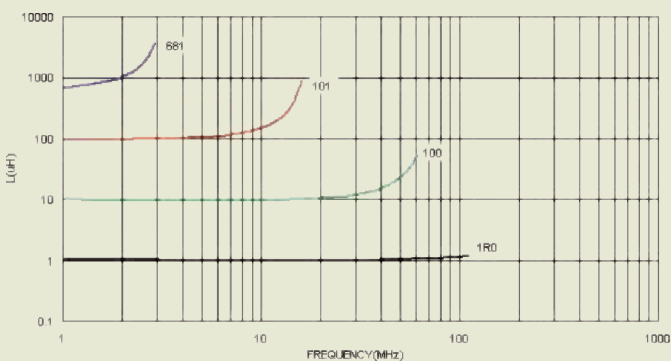

Typical Q vs. Frequency

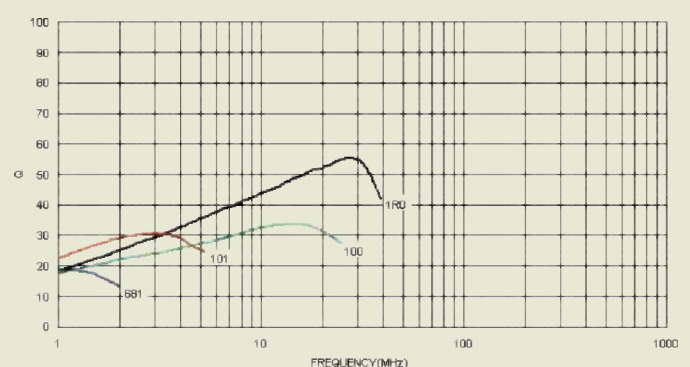



ELECTRICAL CHARACTERISTICS : LEAD-FREE & ROHS COMPLIANCE

PART NO.	INDUCTANCE (μ H)	TEST FREQ (MHZ)	Q Min.	SRF (MHz) Min.	RDC (Ω) Max.	IDC (mA) Max.	TOLERANCE (\pm %)	Color Code		
								1 ST	2 ND	3 RD
NLC322522T-R47 <input type="checkbox"/> -N	0.47	25.2	40	450	0.07	1800	5,10	YEL	VIO	BRN
NLC322522T-1R0 <input type="checkbox"/> -N	1	7.96	20	100	0.08	1500	5,10	BRN	BLK	RED
NLC322522T-1R2 <input type="checkbox"/> -N	1.2	7.96	20	90	0.08	1400	5,10	BRN	RED	RED
NLC322522T-1R5 <input type="checkbox"/> -N	1.5	7.96	20	80	0.13	1125	5,10	BRN	GRN	RED
NLC322522T-1R8 <input type="checkbox"/> -N	1.8	7.96	20	70	0.13	970	5,10	BRN	GRY	RED
NLC322522T-2R2 <input type="checkbox"/> -N	2.2	7.96	20	68	0.13	970	5,10	RED	RED	RED
NLC322522T-2R7 <input type="checkbox"/> -N	2.7	7.96	20	62	0.15	900	5,10	RED	VIO	RED
NLC322522T-3R3 <input type="checkbox"/> -N	3.3	7.96	20	54	0.16	837	5,10	ORN	ORN	RED
NLC322522T-4R7 <input type="checkbox"/> -N	4.7	7.96	20	43	0.23	675	5,10	YEL	VIO	RED
NLC322522T-5R6 <input type="checkbox"/> -N	5.6	7.96	20	36	0.26	620	5,10	GRN	BLU	RED
NLC322522T-6R8 <input type="checkbox"/> -N	6.8	7.96	20	33	0.27	600	5,10	BLU	GRY	RED
NLC322522T-8R2 <input type="checkbox"/> -N	8.2	7.96	20	30	0.32	580	5,10	GRY	RED	RED
NLC322522T-100 <input type="checkbox"/> -N	10	2.52	15	28	0.36	520	5,10	BRN	BLK	ORN
NLC322522T-150 <input type="checkbox"/> -N	15	2.52	15	19	0.56	480	5,10	BRN	GRN	ORN
NLC322522T-180 <input type="checkbox"/> -N	18	2.52	15	17	0.67	330	5,10	BRN	GRY	ORN
NLC322522T-220 <input type="checkbox"/> -N	22	2.52	15	16	0.77	310	5,10	RED	RED	ORN
NLC322522T-270 <input type="checkbox"/> -N	27	2.52	15	13	1	280	5,10	RED	VIO	ORN
NLC322522T-330 <input type="checkbox"/> -N	33	2.52	15	12	1.1	270	5,10	ORN	ORN	ORN
NLC322522T-470 <input type="checkbox"/> -N	47	2.52	15	10	1.64	210	5,10	YEL	VIO	ORN
NLC322522T-680 <input type="checkbox"/> -N	68	2.52	15	9	2.8	189	5,10	BLU	GRY	ORN
NLC322522T-101 <input type="checkbox"/> -N	100	0.796	15	6	3.7	145	5,10	BRN	BLK	YEL
NLC322522T-151 <input type="checkbox"/> -N	150	0.796	15	5	6.1	120	5,10	BRN	GRN	YEL
NLC322522T-181 <input type="checkbox"/> -N	180	0.796	15	4	8	105	5,10	BRN	GRY	YEL
NLC322522T-221 <input type="checkbox"/> -N	220	0.796	15	4	8.4	100	5,10	RED	RED	YEL
NLC322522T-331 <input type="checkbox"/> -N	330	0.796	15	3.5	12.3	80	5,10	ORN	ORN	YEL
NLC322522T-391 <input type="checkbox"/> -N	390	0.796	15	2.8	17.6	75	5,10	YEL	VIO	YEL
NLC322522T-471 <input type="checkbox"/> -N	470	0.796	15	2.8	22	75	5,10	YEL	VIO	YEL
NLC322522T-561 <input type="checkbox"/> -N	560	0.796	15	2.5	23	65	5,10	GRN	BLU	YEL
NLC322522T-681 <input type="checkbox"/> -N	680	0.796	15	2	28	65	5,10	BLU	GRY	YEL

NOTE: -tolerance J= \pm 5% /K= \pm 10% / M= \pm 20%

1. Operating temperature range -25°C~85°C

2.IDC:Applied the current to coils,the inductance shall be less than 10% initial value.

"-N" FOR COMPLETELY LEAD FREE TYPE(INCLUDING FERRITE BODY & SOLDER)



PACKAGING SPECIFICATIONS

Dimensions : mm

TAPE DIMENSIONS

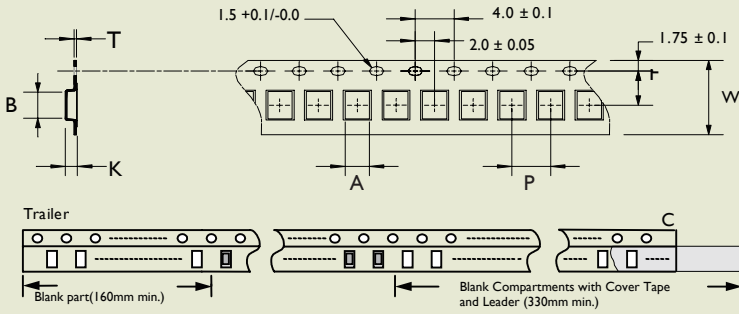

Dimensions : mm

Reel Dimensions

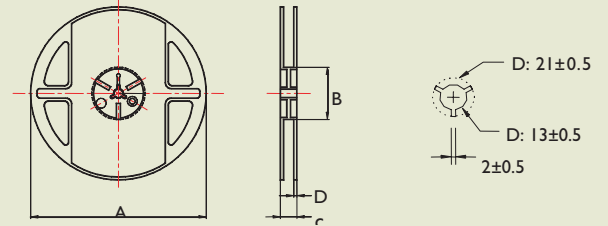

Dimensions : mm

TYPE	TAPE DIMENSIONS							REEL DIMENSIONS				Q'TY/REEL
	A	B	T	W	P	F	K	A	B	C	D	
NLC252018	2.70	2.95	0.23	8	4	3.5	2.25	178	60	12	1.5	2000
NLC322522	2.95	3.85	0.25	12	4	3.5	2.45	178	60	16	1.4	2000

RECOMMEND SOLDERING CONDITIONS

for: CS/ CT/ LCN/ HC/ HQ/ CMM/ NL (open type)/ NLC (open type)/ LS

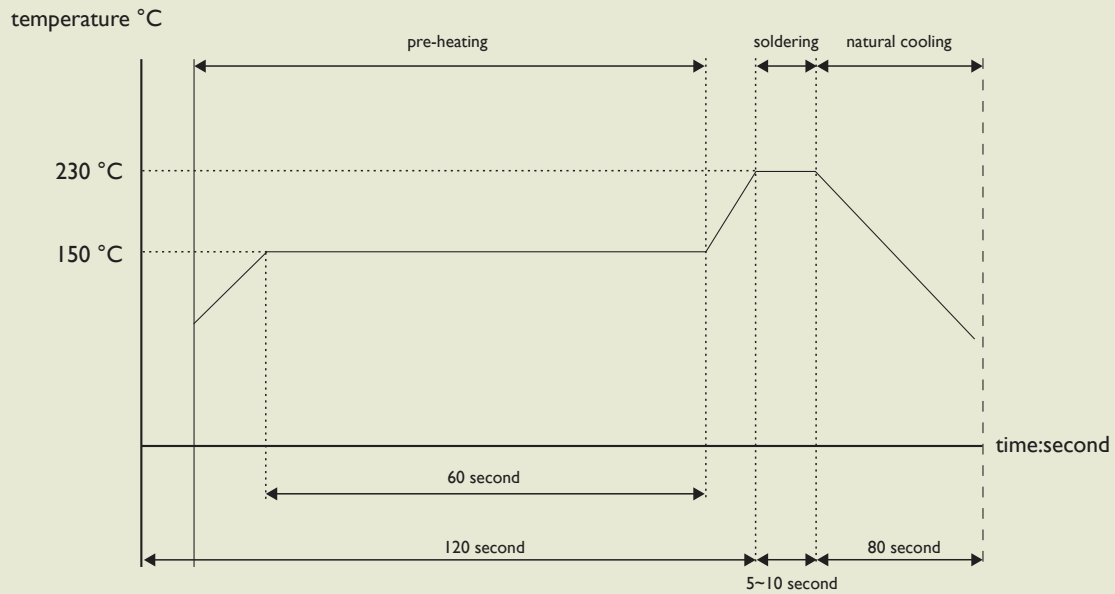

NLC Series

Molded Type / For High Current Application

Wound Chip Inductors

The characteristics of NLC series (molded type) features low RDC and high current handling capacities. These chip inductors are ideal for power supply applications such as PC, conveyable telephone, and so on.

APPLICATIONS

- Portable Telephones
- Personal computers
- HHDs.
- Other electronics appliances.

FEATURES

- Low RDC, large current type
- Best for power supply line.
- Available in 2 sizes.

RECOMMENDED PATTERN

Dimensions : mm

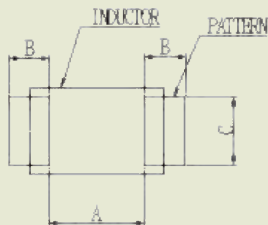

TYPE	A	B	C
NLC453232	3.0	1.5	2.8
NLC565050	4.0	2.0	4.5



PRODUCT IDENTIFICATION

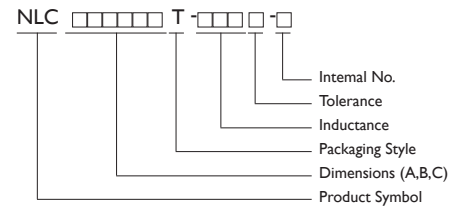

- Packaging : T :Tape and Reel ; B : Bulk
- Tolerance : J=±5% ; K= ±10%
- YAGEO will start to release lead-free that meet SONY SS-00259's criteria, and Internal No. will be changed to "N" as identification.
Ex. NLC453232T-1R0K-N

SHAPES AND DIMENSIONS

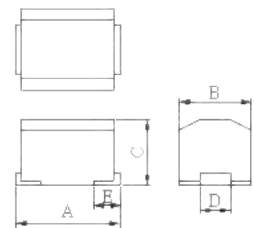

TYPE	A	B	C	D	E
NLC453232	4.5±0.3	3.2±0.3	3.2±0.3	1.4±0.4	0.9±0.2
NLC565050	5.6±0.3	5.0±0.3	5.0±0.3	1.8±0.3	1.3±0.2



ELECTRICAL CHARACTERISTICS

PART NO.	INDUCTANCE	TOLERANCE	Q	TEST FREQUENCY	SRF	DC RESISTANCE	IDC
	(μH)	($\pm\%$)	Min.	(MHz)	(MHz) Min.	(Ω) Max.	(mA) Max.
NLC453232T-1R0K-S	1.0	10	10	7.96	200	0.11	1050
NLC453232T-1R2K-S	1.2	10	10	7.96	155	0.12	1000
NLC453232T-1R5K-S	1.5	10	10	7.96	130	0.15	950
NLC453232T-1R8K-S	1.8	10	10	7.96	100	0.16	900
NLC453232T-2R2K-S	2.2	10	10	7.96	80	0.18	850
NLC453232T-2R7K-S	2.7	10	10	7.96	55	0.20	800
NLC453232T-3R3K-S	3.3	10	10	7.96	45	0.22	750
NLC453232T-3R9K-S	3.9	10	10	7.96	40	0.24	700
NLC453232T-4R7K-S	4.7	10	10	7.96	35	0.27	650
NLC453232T-5R6K-S	5.6	10	10	7.96	30	0.30	650
NLC453232T-6R8K-S	6.8	10	10	7.96	28	0.35	600
NLC453232T-8R2K-S	8.2	10	10	7.96	25	0.40	600
NLC453232T-100K-S	10	10	10	2.52	22	0.50	550
NLC453232T-120K-S	12	10	10	2.52	21	0.60	500
NLC453232T-150K-S	15	10	10	2.52	20	0.70	450
NLC453232T-180K-S	18	10	10	2.52	18	0.80	400
NLC453232T-220K-S	22	10	10	2.52	17	0.90	370
NLC453232T-270K-S	27	10	10	2.52	15	1.20	330
NLC453232T-330K-S	33	10	10	2.52	14	1.40	300
NLC453232T-390K-S	39	10	10	2.52	12	1.60	280
NLC453232T-470K-S	47	10	10	2.52	11.5	1.90	260
NLC453232T-560K-S	56	10	10	2.52	10.5	2.20	240
NLC453232T-680K-S	68	10	10	2.52	9	2.60	220
NLC453232T-820K-S	82	10	10	2.52	8.5	3.50	200
NLC453232T-101K-S	100	10	20	0.796	7.0	4.00	180
NLC453232T-121K-S	120	10	20	0.796	6.5	4.50	160
NLC453232T-151K-S	150	10	20	0.796	6	6.50	140
NLC453232T-181K-S	180	10	20	0.796	5.5	7.50	120
NLC453232T-221K-S	220	10	20	0.796	5.0	9.00	120
NLC453232T-271K-S	270	10	20	0.796	4.5	11.0	100
NLC453232T-331K-S	330	10	20	0.796	4	13.0	90

• Test Instruments: HP4286A RF Impedance Analyzer for L · Q · SRF Digital Multimeter CH502BC/ HP4338B for RDC
HP4286A LF Impedance Analyzer for L · Q · HP4284A+HP42841A for IDC

TEST INSTRUMENTS : HP4291A Impedance / Material Analyzer

Inductance vs. Frequency characteristics

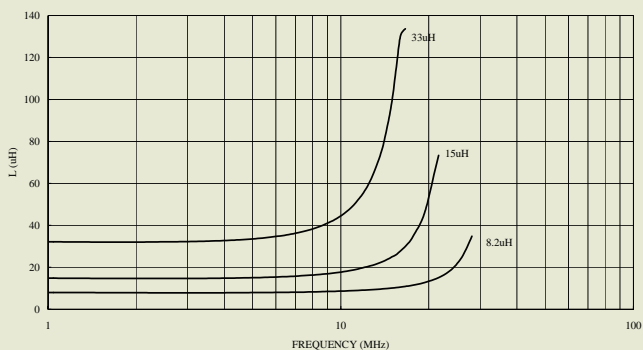

Q vs. Frequency characteristics

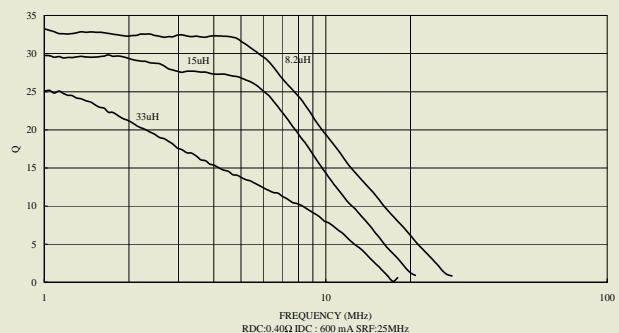



ELECTRICAL CHARACTERISTICS

PART NO.	INDUCTANCE (μH)	TOLERANCE ($\pm\%$)	Q Min.	TEST FREQUENCY (MHz)	SRF (MHz) Min.	DC RESISTANCE (Ω) Max.	IDC (mA) Max.
NLC565050T-1R0K-S	1.0	10	10	7.96	95	0.03	1800
NLC565050T-1R2K-S	1.2	10	10	7.96	70	0.035	1700
NLC565050T-1R5K-S	1.5	10	10	7.96	55	0.04	1600
NLC565050T-1R8K-S	1.8	10	10	7.96	47	0.05	1400
NLC565050T-2R2K-S	2.2	10	10	7.96	42	0.06	1300
NLC565050T-2R7K-S	2.7	10	10	7.96	37	0.07	1200
NLC565050T-3R3K-S	3.3	10	10	7.96	34	0.08	1120
NLC565050T-3R9K-S	3.9	10	10	7.96	32	0.09	1050
NLC565050T-4R7K-S	4.7	10	10	7.96	29	0.11	950
NLC565050T-5R6K-S	5.6	10	10	7.96	26	0.13	880
NLC565050T-6R8K-S	6.8	10	10	7.96	24	0.15	810
NLC565050T-8R2K-S	8.2	10	10	7.96	22	0.18	750
NLC565050T-100K-S	10	10	10	2.52	19	0.21	690
NLC565050T-120K-S	12	10	10	2.52	17	0.25	630
NLC565050T-150K-S	15	10	10	2.52	16	0.30	580
NLC565050T-180K-S	18	10	10	2.52	14	0.36	530
NLC565050T-220K-S	22	10	10	2.52	13	0.43	480
NLC565050T-270K-S	27	10	10	2.52	11.5	0.52	440
NLC565050T-330K-S	33	10	10	2.52	10.5	0.62	400
NLC565050T-390K-S	39	10	10	2.52	9.5	0.72	370
NLC565050T-470K-S	47	10	10	2.52	8.5	0.85	340
NLC565050T-560K-S	56	10	10	2.52	7.8	1.00	310
NLC565050T-680K-S	68	10	10	2.52	7	1.2	290
NLC565050T-820K-S	82	10	10	2.52	6.4	1.4	270
NLC565050T-101K-S	100	10	20	0.796	6	1.6	250
NLC565050T-121K-S	120	10	20	0.796	5.4	1.9	230
NLC565050T-151K-S	150	10	20	0.796	4.8	2.2	210
NLC565050T-181K-S	180	10	20	0.796	4.4	2.8	190
NLC565050T-221K-S	220	10	20	0.796	3.9	3.4	170
NLC565050T-271K-S	270	10	20	0.796	3.6	4.2	155
NLC565050T-331K-S	330	10	20	0.796	3.2	4.9	140
NLC565050T-391K-S	390	10	20	0.796	2.9	5.8	130
NLC565050T-471K-S	470	10	20	0.796	2.6	7	120
NLC565050T-561K-S	560	10	20	0.796	2.4	8.5	110
NLC565050T-681K-S	680	10	20	0.796	2.2	10	100
NLC565050T-821K-S	820	10	20	0.796	2	13	90
NLC565050T-102K-S	1000	10	20	0.252	1.8	15	85

Test Instruments : P4286A RF Impedance Analyzer for L · Q · SRF Digital Multimeter CH502BC / HP4338B for RDC
 HP4285A LF Impedance Analyzer for L · Q · HP4284A+HP42841A for IDC



ELECTRICAL CHARACTERISTICS : LEAD-FREE & ROHS COMPLIANCE

PART NO.	INDUCTANCE (μ H)	TEST FREQ (MHz)	Q Min.	SRF (MHz) Min.	RDC (Ω) Max.	IDC (mA) Max.	TOLERANCE (\pm %)
NLC453232T-1R0 □ -N	1	7.96	10	200	0.11	1050	5,10
NLC453232T-1R2 □ -N	1.2	7.96	10	155	0.12	1000	5,10
NLC453232T-1R5 □ -N	1.5	7.96	10	130	0.15	950	5,10
NLC453232T-1R8 □ -N	1.8	7.96	10	100	0.16	900	5,10
NLC453232T-2R2 □ -N	2.2	7.96	10	80	0.18	850	5,10
NLC453232T-2R7 □ -N	2.7	7.96	10	55	0.2	800	5,10
NLC453232T-3R3 □ -N	3.3	7.96	10	45	0.22	750	5,10
NLC453232T-3R9 □ -N	3.9	7.96	10	40	0.24	700	5,10
NLC453232T-4R7 □ -N	4.7	7.96	10	35	0.27	650	5,10
NLC453232T-5R6 □ -N	5.6	7.96	10	30	0.3	650	5,10
NLC453232T-6R8 □ -N	6.8	7.96	10	28	0.35	600	5,10
NLC453232T-8R2 □ -N	8.2	7.96	10	25	0.4	600	5,10
NLC453232T-100 □ -N	10	2.52	10	22	0.5	550	5,10
NLC453232T-120 □ -N	12	2.52	10	21	0.6	500	5,10
NLC453232T-150 □ -N	15	2.52	10	20	0.7	450	5,10
NLC453232T-180 □ -N	18	2.52	10	18	0.8	400	5,10
NLC453232T-220 □ -N	22	2.52	10	17	0.9	370	5,10
NLC453232T-270 □ -N	27	2.52	10	15	1.2	330	5,10
NLC453232T-330 □ -N	33	2.52	10	14	1.4	300	5,10
NLC453232T-390 □ -N	39	2.52	10	12	1.6	280	5,10
NLC453232T-470 □ -N	47	2.52	10	11.5	1.9	260	5,10
NLC453232T-560 □ -N	56	2.52	10	10.5	2.2	240	5,10
NLC453232T-680 □ -N	68	2.52	10	9	2.6	220	5,10
NLC453232T-820 □ -N	82	2.52	10	8.5	3.5	200	5,10
NLC453232T-101 □ -N	100	0.796	20	7	4	180	5,10
NLC453232T-121 □ -N	120	0.796	20	6.5	4.5	160	5,10
NLC453232T-151 □ -N	150	0.796	20	6	6.5	140	5,10
NLC453232T-181 □ -N	180	0.796	20	5.5	7.5	120	5,10
NLC453232T-221 □ -N	220	0.796	20	5	9	120	5,10
NLC453232T-271 □ -N	270	0.796	20	4.5	11	100	5,10
NLC453232T-331 □ -N	330	0.796	20	4	13	90	5,10
NLC453232T-471 □ -N	470	0.796	20	3.5	19	70	5,10
NLC453232T-561 □ -N	560	0.796	20	2.5	21	60	5,10
NLC453232T-681 □ -N	680	0.796	20	2	30	60	5,10

NOTE: □-tolerance J= \pm 5% / K= \pm 10% / M= \pm 20%

1.Operating temperature range -25°C~85°C

2.IDC:Applied the current to coils,the inductance shall be less than 10% initial value.

"-N" FOR COMPLETELY LEAD FREE TYPE(INCLUDING FERRITE BODY & SOLDER)



ELECTRICAL CHARACTERISTICS : LEAD-FREE & ROHS COMPLIANCE

PART NO.	INDUCTANCE (μ H)	TEST FREQ (MHz)	Q Min.	SRF (MHz) Min.	RDC (Ω) Max.	IDC (mA) Max.	TOLERANCE ($\pm\%$)
NLC565050T-1R0K-N	1	7.96	10	95	0.03	1800	10
NLC565050T-1R2K-N	1.2	7.96	10	70	0.035	1700	10
NLC565050T-1R5K-N	1.5	7.96	10	55	0.04	1600	10
NLC565050T-1R8K-N	1.8	7.96	10	47	0.05	1400	10
NLC565050T-2R2K-N	2.2	7.96	10	42	0.06	1300	10
NLC565050T-2R7K-N	2.7	7.96	10	37	0.07	1200	10
NLC565050T-3R3K-N	3.3	7.96	10	34	0.08	1120	10
NLC565050T-3R9K-N	3.9	7.96	10	32	0.09	1050	10
NLC565050T-4R7K-N	4.7	7.96	10	29	0.11	950	10
NLC565050T-5R6K-N	5.6	7.96	10	26	0.13	880	10
NLC565050T-6R8K-N	6.8	7.96	10	24	0.15	810	10
NLC565050T-8R2K-N	8.2	7.96	10	22	0.18	750	10
NLC565050T-100K-N	10	2.52	10	19	0.21	690	10
NLC565050T-120K-N	12	2.52	10	17	0.25	630	10
NLC565050T-150K-N	15	2.52	10	16	0.3	580	10
NLC565050T-180K-N	18	2.52	10	14	0.36	530	10
NLC565050T-220K-N	22	2.52	10	13	0.43	480	10
NLC565050T-270K-N	27	2.52	10	11.5	0.52	440	10
NLC565050T-330K-N	33	2.52	10	10.5	0.62	400	10
NLC565050T-390K-N	39	2.52	10	9.5	0.72	370	10
NLC565050T-470K-N	47	2.52	10	8.5	0.85	340	10
NLC565050T-560K-N	56	2.52	10	7.8	1	310	10
NLC565050T-680K-N	68	2.52	10	7	1.2	290	10
NLC565050T-820K-N	82	2.52	10	6.4	1.4	270	10
NLC565050T-101K-N	100	0.796	20	6	1.6	250	10
NLC565050T-121K-N	120	0.796	20	5.4	1.9	230	10
NLC565050T-151K-N	150	0.796	20	4.8	2.2	210	10
NLC565050T-181K-N	180	0.796	20	4.4	2.8	190	10
NLC565050T-221K-N	220	0.796	20	3.9	3.4	170	10
NLC565050T-271K-N	270	0.796	20	3.6	4.2	155	10
NLC565050T-331K-N	330	0.796	20	3.2	4.9	140	10
NLC565050T-391K-N	390	0.796	20	2.9	5.8	130	10
NLC565050T-471K-N	470	0.796	20	2.6	7	120	10
NLC565050T-561K-N	560	0.796	20	2.4	8.5	110	10
NLC565050T-681K-N	680	0.796	20	2.2	10	100	10
NLC565050T-821K-N	820	0.796	20	2	13	90	10
NLC565050T-102K-N	1000	0.252	20	1.8	15	85	10

NOTE: -tolerance K= $\pm 10\%$

1. Operating temperature range -25°C ~ 85°C

2.IDC: Applied the current to coils, the inductance shall be less than 10% initial value.

"-N" FOR COMPLETELY LEAD FREE TYPE(INCLUDING FERRITE BODY & SOLDER)



TEST INSTRUMENTS : HP4291A IMPEDANCE / MATERIAL ANALYZER

INDUCTANCE vs. FREQUENCY CHARACTERISTICS

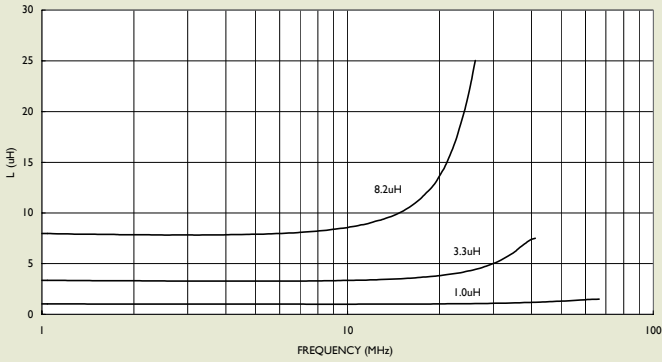

Q vs. FREQUENCY CHARACTERISTICS

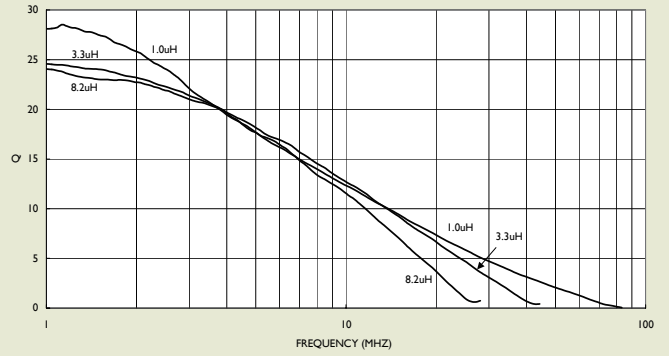

PACKAGING SPECIFICATIONS

Tape Dimensions

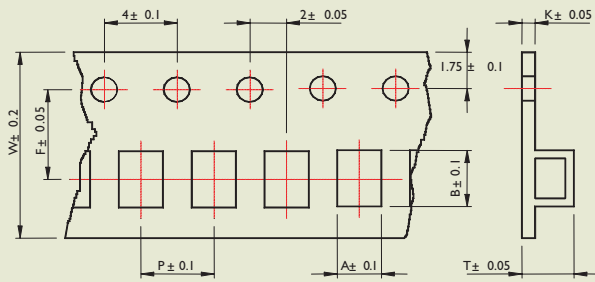

Tape Material

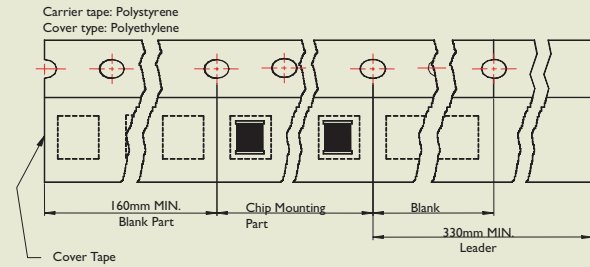

Reel Dimensions

Figure 1

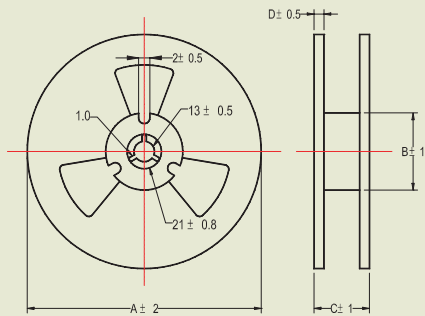
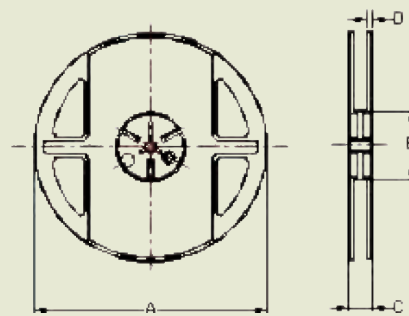

Figure 2



Dimensions : mm

TYPE	TAPE DIMENSIONS								REEL DIMENSIONS				Q'TY/REEL
	A	B	T	W	P	F	K	FIG	A	B	C	D	
NLC453232	3.3	5.00	3.50	12	8	5.5	0.3	2	178	60	16	1.4	500
NLC565050	5.35	6.10	5.50	16	12	7.5	0.35	1	330	100	22	2.3	1000



RECOMMEND SOLDERING CONDITIONS

for:CS/ CT/ LCN/ HC/ HQ/ CMM/ NL (open type)/ NLC (open type)/ LS

