

FEATURES

- $V_{DRM}=400$ to 800 V
- $I_{TRMS}=300$ mA
- $dv/dt_{cr} \geq 10,000$ V/ μ s
- Electrically Insulated Between Input and Output Circuit
- Microcomputer Compatible—Very Low Trigger Current
- Trigger Current:
 - BRT21/22/23 H, <2 mA
 - BRT21/22/23 M, <3
- Options Available:
 - Option 1—Per VDE 0884
 - Option 6—Leads with 0.4" (10.16 mm) Spacing
 - Option 7—Lead Bends for Surface Mounting
- DIP-6 Package
- Underwriters Lab File #E52744, Code Letter "J"

Maximum Ratings

($T_J=25^\circ\text{C}$ unless otherwise specified)

Input Circuit

Reverse Voltage	6 V
Continuous Forward Current	20 mA
Surge Forward Current, $t_s \leq 10 \mu\text{s}$	1.5 A
Maximum Power Dissipation	30 mW

Output Circuit

Repetitive Peak Off-State Voltage	
BRT21	400 V
BRT22	600 V
BRT23	800 V
RMS On-State Current	300 mA
Single Cycle Surge Current (50 Hz)	3 A
Maximum Power Dissipation	600 mW

AC Switch

Isolation Test Voltage	
Between Input/Output Circuit	
(Climax per DIN 40 046, Part 2, Nov. 74)	5300 VDC
Reference Voltage per VDE 0110b	
(Insulation Group C)	500VAC _{eff} /600 VDC
Creepage Distance (input/output circuit)	28.2 mm
Clearance (input/output circuit)	7.2 mm
Creepage Tracking Resistance per DIN IEC 112/VDE	
0303, part 1	175 Group IIIa per DIN VDE 0109
Insulation Resistance	
$V_{IO}=500$ V, $T_A=25^\circ\text{C}$	$10^{12} \Omega$
$V_{IO}=500$ V, $T_A=100^\circ\text{C}$	$10^{11} \Omega$
Humidity Category (DIN 40 040)	F
Maximum Power Dissipation	630 mW
Operating Temperature Range	-40°C to $+100^\circ\text{C}$
Storage Temperature Range	-40°C to $+150^\circ\text{C}$

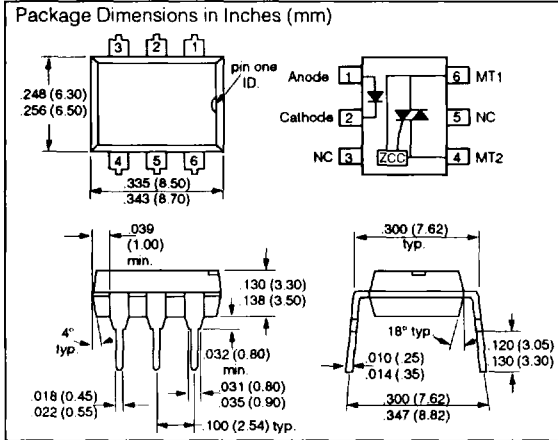

DESCRIPTION

The BRT21/22/23 are AC switch optocouplers with zero voltage detectors consisting of two electrically insulated lateral power ICs which integrate a thyristor system, a photo detector and noise suppression at the output and an IR GaAs diode at the input.

Characteristics ($T_J=25^\circ\text{C}$, unless otherwise specified)

	Symbol	Min.	Typ.	Max.	Unit	Condition
Output Circuit						
Off State Current	$I_{D(RMS)}^1$		100		μA	$V_D=600$ V, $T_A=100^\circ\text{C}$, $I_F=0$ mA
Off State Current	$I_{D(RMS)}^2$		200		μA	$V_D=600$ V, $I_F=\text{rated } I_{FT}$ $I_T=300$ mA
On-State Voltage	V_T		2.3		V	$T_J=25^\circ\text{C}$, V_{DRM}
Reverse Current	I_D	7	30		μA	$T_J=80^\circ\text{C}$, $T_J=100^\circ\text{C}$, V_{DRM}
Holding Current	I_H	12	100		μA	$V_D=10$ V
Critical Rate of Rise						
Off-Stage Voltage	dv/dt_{cr}	1000			V/ μs	$T_J=25^\circ\text{C}$, $V_D=0.67 V_{DRM}$
	dv/dt_{crq}	5000			V/ μs	$T_J=80^\circ\text{C}$, $V_D=0.67 V_{DRM}$
Voltage at Current						
Commutation	dv/dt_{crq}	10,000			V/ μs	$T_J=25^\circ\text{C}$, $V_D=0.67 V_{DRM}$, $di/dt_{crq} \leq 15$ A/ms
	dv/dt_{crq}	5000			V/ μs	$T_J=80^\circ\text{C}$, $V_D=0.67 V_{DRM}$, $di/dt_{crq} \leq 15$ A/ms
On-Stage Voltage	dv/dt_{cr}		8		A/ μs	
Thermal Resistance						
Junction-Ambient	R_{thJA}		125		$^\circ\text{C}/\text{W}$	
Package						
Trigger Current	I_{FT}					
Type H			2.0		mA	$V_D=10$ V
Type M			3.0		mA	$V_D=10$ V
Input-Output						
Capacitance	C_{IO}		2		pF	$V_{IO}=0$, $f=1$ MHz
Zero Crossing						
Inhibit Voltage	V_{IH}	15	25		V	$I_F=\text{rated } I_{FT}$

Trigger delay time (typ.)
 $t_{pd} = f(I_F / I_{F125^\circ C})$, $V_D = 200$ V, Parameter: T_J

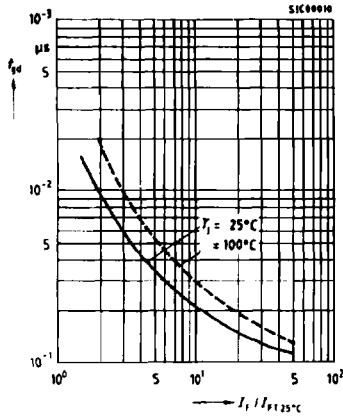

Off-state current (typ.)
 $I_D = f(T_J)$, $V_D = 800$ V, Parameter: T_J

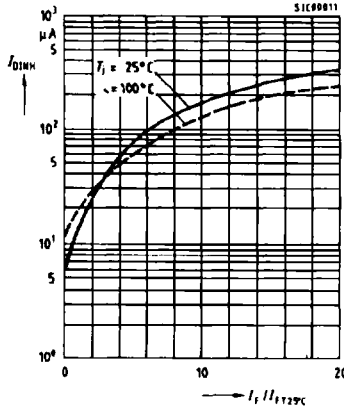

Power dissipation, 40 to 60 Hz line operation, $P_{tot} = f(I_{TRMS})$

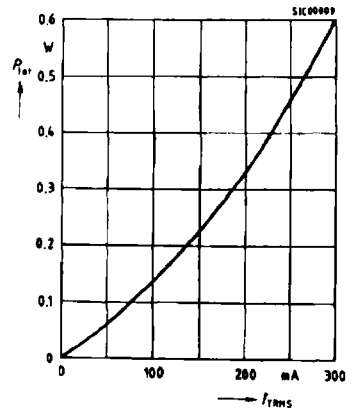

Static inhibit voltage limit (typ.)
 $V_{DINHmin} = f(I_F / I_{F25^\circ C})$, parameter: T_J
 SiTAC zero voltage triggered only in hatched area below T_J curves

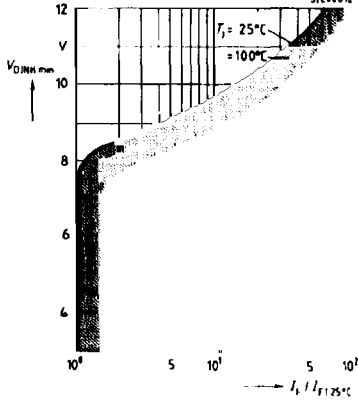

Input characteristics (typ.)
 $I_F = f(V_F)$, parameter: T_J

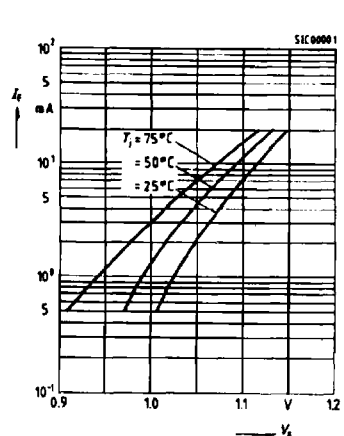

Output characteristics (typ.)
 $I_T = f(V_T)$, parameter: T_J

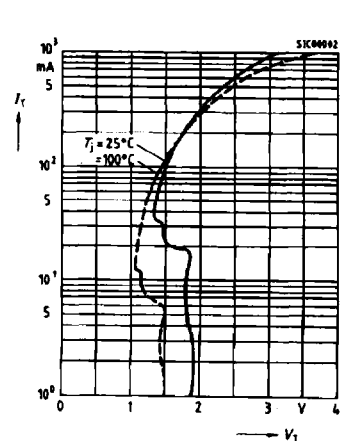

Current reduction $I_{TRMS} = f(T_A)$, $R_{thJA} = 125$ K/W
 SiTAC switch soldered in PCB or base plate

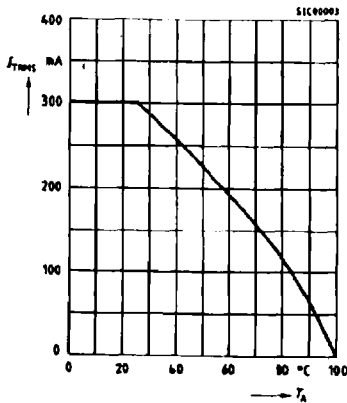

Current reduction $I_{TRMS} = f(T_{PIN S})$, $R_{thJ-PIN S} = 16.5$ K/W
 Thermocouple measurement must be performed potentially separated to A1 and A2. Measuring junction near to case as possible.

