

# Precision Low Noise JFET Operational Amplifiers

## ISL28110, ISL28210

The ISL28110, ISL28210, are single and dual JFET amplifiers featuring low noise, high slew rate, low input bias current and offset voltage, making them the ideal choice for high impedance applications where precision and low noise are important. The combination of precision, low noise, and high speed combined with a small footprint provides the user with outstanding value and flexibility relative to similar competitive parts.

Applications for these amplifiers include precision medical and analytical instrumentation, sensor conditioning, precision power supply controls, industrial controls and photodiode amplifiers.

The ISL28110 single amplifier is available in the 8 Ld SOIC, TDFN, and MSOP packages. The ISL28210 dual amplifier is available in the 8 Ld SOIC and TDFN packages. All devices are offered in standard pin configurations and operate over the extended temperature range from  $-40^{\circ}\text{C}$  to  $+125^{\circ}\text{C}$ .

## Features

- Wide Supply Range. . . . . 9V to 40V
- Low Voltage Noise . . . . . 6nV/ $\sqrt{\text{Hz}}$
- Input Bias Current . . . . . 2pA
- High Slew Rate. . . . . 23V/ $\mu\text{s}$
- High Bandwidth . . . . . 12.5MHz
- Low Input Offset . . . . . 300 $\mu\text{V}$ , Max
- Offset Drift . . . . . Grade C 10 $\mu\text{V}/^{\circ}\text{C}$
- Low Current Consumption . . . . . 2.55mA
- Operating Temperature Range . . .  $-40^{\circ}\text{C}$  to  $+125^{\circ}\text{C}$
- Small Package Offerings in Single, and Dual
- Pb-Free (RoHS compliant)

## Applications\* (see page 16)

- Precision Instruments
- Photodiode Amplifiers
- High Impedance Buffers
- Medical Instrumentation
- Active Filter Blocks
- Industrial Controls

## Typical Application

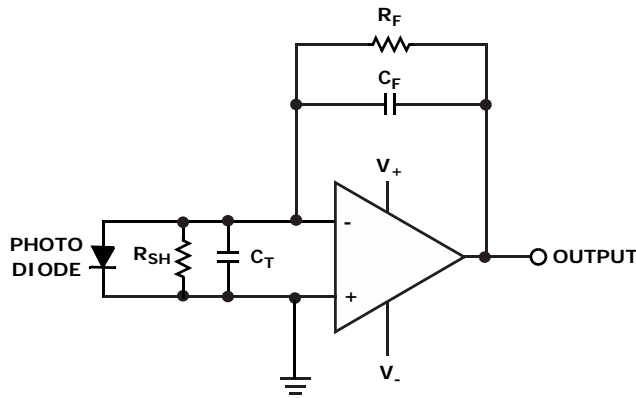

BASIC APPLICATION CIRCUIT - PHOTODIODE AMPLIFIER

## Input Bias Current vs Common Mode Input Voltage

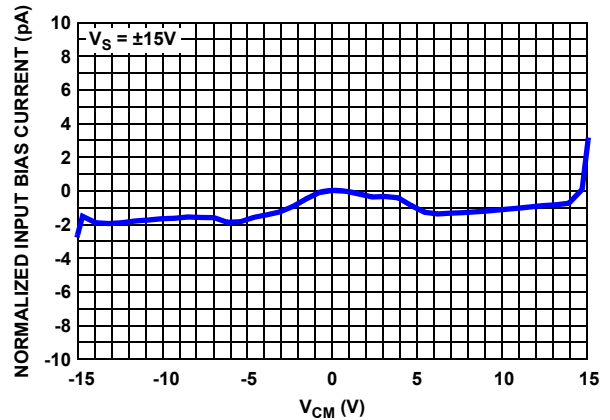

## Pin Configurations

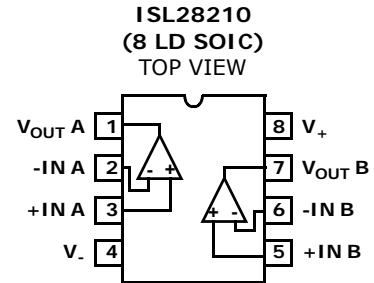
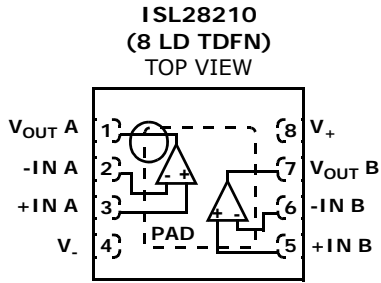
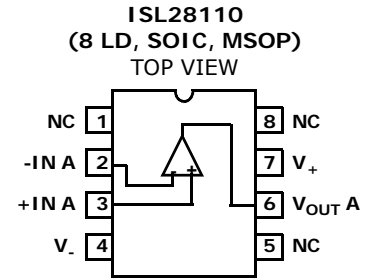
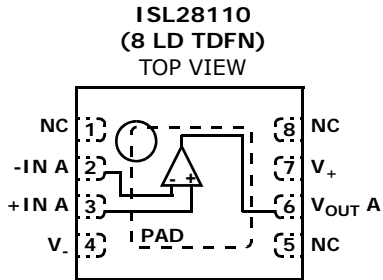

## Pin Descriptions

ISL28110 (8 Ld TDFN)	ISL28110 (8 Ld SOIC, 8 Ld MSOP)	ISL28210 (8 Ld TDFN)	ISL28210 (8 Ld SOIC)	PIN NAME	EQUIVALENT CIRCUIT	DESCRIPTION
3	3	3	3	+IN A	Circuit 1	Amplifier A non-inverting input
2	2	2	2	-IN A	Circuit 1	Amplifier A inverting input
6	6	1	1	V <sub>OUT A</sub>	Circuit 2	Amplifier A output
4	4	4	4	V <sub>-</sub>	Circuit 3	Negative power supply
		5	5	+IN B	Circuit 1	Amplifier B non-inverting input
		6	6	-IN B	Circuit 1	Amplifier B inverting input
		7	7	V <sub>OUT B</sub>	Circuit 2	Amplifier B output
7	7	8	8	V <sub>+</sub>	Circuit 3	Positive power supply
1, 5, 8	1, 5, 8					No connect
PAD		PAD		PAD		Thermal Pad is electrically isolated from active circuitry. Pad can float, connect to Ground or to a potential source that is free from signals or noise sources.

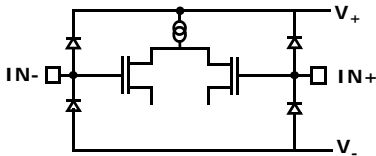

CIRCUIT 1

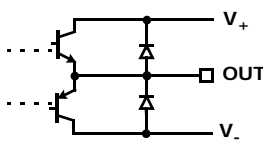

CIRCUIT 2

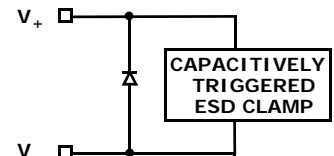

CIRCUIT 3

## Ordering Information

PART NUMBER (Notes 1, 2, 3)	PART MARKING	TCV <sub>Os</sub> ( $\mu\text{V}/^{\circ}\text{C}$ )	PACKAGE (Pb-free)	PKG. DWG. #
<i>Coming Soon</i> ISL28110FBZ	28110 FBZ -C	10 (C Grade)	8 Ld SOIC	M8.15E
ISL28210FBZ	28210 FBZ -C	10 (C Grade)	8 Ld SOIC	M8.15E
<i>Coming Soon</i> ISL28110FRTZ	-C 8110	10 (C Grade)	8 Ld TDFN	L8.3x3A
<i>Coming Soon</i> ISL28210FRTZ	-C 8210	10 (C Grade)	8 Ld TDFN	L8.3x3A
<i>Coming Soon</i> ISL28110FRTBZ	8110	4 (B Grade)	8 Ld TDFN	L8.3x3A
<i>Coming Soon</i> ISL28210FRTBZ	8210	4 (B Grade)	8 Ld TDFN	L8.3x3A
<i>Coming Soon</i> ISL28110FBBZ	28110 FBZ -C	4 (B Grade)	8 Ld SOIC	M8.15E
<i>Coming Soon</i> ISL28210FBBZ	28210 FBZ	4 (B Grade)	8 Ld SOIC	M8.15E
<i>Coming Soon</i> ISL28110FUBZ	8110Z	4 (B Grade)	8 Ld MSOP	M8.118
<i>Coming Soon</i> ISL28110FUZ	8110Z	10 (C Grade)	8 Ld MSOP	M8.118

## NOTES:

1. Add "-T7", "-T13" or "-T7A" suffix for tape and reel. Please refer to [TB347](#) for details on reel specifications.
2. These Intersil Pb-free plastic packaged products employ special Pb-free material sets, molding compounds/die attach materials, and 100% matte tin plate plus anneal (e3 termination finish, which is RoHS compliant and compatible with both SnPb and Pb-free soldering operations). Intersil Pb-free products are MSL classified at Pb-free peak reflow temperatures that meet or exceed the Pb-free requirements of IPC/JEDEC J STD-020.
3. For Moisture Sensitivity Level (MSL), please see device information page for [ISL28110](#), [ISL28210](#). For more information on MSL please see techbrief [TB363](#).

# ISL28110, ISL28210

## Absolute Voltage Ratings

Maximum Supply Voltage	42V
Maximum Supply Turn On Voltage Slew Rate	1V/ $\mu$ s
Maximum Differential Input Voltage	33V
Min/Max Input Voltage	$V_- - 0.5V$ to $V_+ + 0.5V$
Max/Min Input current for input voltage $>V_+$ or $<V_-$	$\pm 20mA$
Output Short-Circuit Duration (1 output at a time)	Indefinite
ESD Ratings	
Human Body Model	4000V
Machine Model	400V
Charged Device Model	2000V

## Thermal Information

Thermal Resistance (Typical)	$\theta_{JA}$ ( $^{\circ}C/W$ )	$\theta_{JC}$ ( $^{\circ}C/W$ )
8 Ld SOIC (Notes 5, 7)		
ISL28110	125	70
ISL28210	120	50
8 Ld TDFN (Notes 4, 6)		
ISL28110	48	7.8
ISL28210	46	4.5
8 Ld MSOP (Notes 5, 7)		
ISL28110	158	60
Ambient Operating Temperature Range	-40 $^{\circ}C$ to +125 $^{\circ}C$	
Storage Temperature Range	-65 $^{\circ}C$ to +150 $^{\circ}C$	
Operating Junction Temperature	+150 $^{\circ}C$	
Pb-Free Reflow Profile	.see link below <a href="http://www.intersil.com/pbfree/Pb-FreeReflow.asp">http://www.intersil.com/pbfree/Pb-FreeReflow.asp</a>	

**CAUTION:** Do not operate at or near the maximum ratings listed for extended periods of time. Exposure to such conditions may adversely impact product reliability and result in failures not covered by warranty.

### NOTES:

- $\theta_{JA}$  is measured in free air with the component mounted on a high effective thermal conductivity test board with "direct attach" features. See Tech Brief TB379.
- $\theta_{JA}$  is measured with the component mounted on a high effective thermal conductivity test board in free air. See Tech Brief TB379 for details.
- For  $\theta_{JC}$ , the "case temp" location is the center of the exposed metal pad on the package underside.
- For  $\theta_{JC}$ , the "case temp" location is taken at the package top center.

**Electrical Specifications**  $V_S = \pm 5V$ ,  $V_{CM} = 0$ ,  $V_O = 0V$ ,  $T_A = +25^{\circ}C$ , unless otherwise noted. **Boldface limits apply over the operating temperature range, -40 $^{\circ}C$  to +125 $^{\circ}C$ .**

PARAMETER	DESCRIPTION	CONDITIONS	MIN (Note 8)	TYP	MAX (Note 8)	UNITS
<b>INPUT CHARACTERISTICS</b>						
$V_{OS}$	Input Offset Voltage		-300		300	$\mu V$
		$-40^{\circ}C \leq T_A \leq +125^{\circ}C$	<b>-1300</b>		<b>1300</b>	$\mu V$
$TCV_{OS}$	Input Offset Voltage Temperature Coefficient	$-40^{\circ}C \leq T_A \leq +125^{\circ}C$		<b>1</b>	<b>10</b>	$\mu V/C$
$I_B$	Input Bias Current (Note 9)		-2	$\pm 0.3$	2	pA
		$-40^{\circ}C < T_A < +60^{\circ}C$	-4.5		4.5	pA
		$-40^{\circ}C < T_A < +85^{\circ}C$	-50		50	pA
		$-40^{\circ}C \leq T_A \leq +125^{\circ}C$	<b>-245</b>		<b>245</b>	pA
$I_{OS}$	Input Offset Current (Note 9)		-1	$\pm 0.15$	1	pA
		$-40^{\circ}C < T_A < +60^{\circ}C$	-2.25		2.25	pA
		$-40^{\circ}C < T_A < +85^{\circ}C$	-30		30	pA
		$-40^{\circ}C \leq T_A \leq +125^{\circ}C$	<b>-105</b>		<b>105</b>	pA
$C_{IN-DIFF}$	Differential Input Capacitance			8.3		pF
$C_{IN-CM}$	Common Mode Input Capacitance			11.8		pF
$R_{IN-DIFF}$	Differential Input Resistance			530		G $\Omega$
$R_{IN-CM}$	Common Mode Input Resistance			560		G $\Omega$
$V_{CMIR}$	Common Mode Input Voltage Range	Guaranteed by CMRR test	$V_- + 1.5$		$V_+ - 1.5$	V
			<b><math>V_- + 2.5</math></b>		<b><math>V_+ - 2.5</math></b>	V

# ISL28110, ISL28210

**Electrical Specifications**  $V_S = \pm 5V$ ,  $V_{CM} = 0$ ,  $V_O = 0V$ ,  $T_A = +25^\circ C$ , unless otherwise noted. **Boldface limits apply over the operating temperature range,  $-40^\circ C$  to  $+125^\circ C$ .** (Continued)

PARAMETER	DESCRIPTION	CONDITIONS	MIN (Note 8)	TYP	MAX (Note 8)	UNITS
CMRR	Common Mode Rejection Ratio	$V_{CM} = -3.5V$ to $+3.5V$		90		dB
		$V_{CM} = -2.5V$ to $+2.5V$	<b>88</b>	<b>100</b>		dB
$A_{VOL}$	Open-loop Gain	$R_L = 10k\Omega$ to ground $V_O = -3V$ to $+3V$		165	240	V/mV
			<b>155</b>			V/mV
<b>DYNAMIC PERFORMANCE</b>						
GBWP	Gain-bandwidth Product	$G = 100$ , $R_L = 100k\Omega$ , $C_L = 4pF$	11	12.5		MHz
SR	Slew Rate, $V_{OUT}$ 20% to 80%	$G = -1$ , $R_L = 2k\Omega$		23		V/ $\mu s$
THD+N	Total Harmonic Distortion + Noise	$G = 1$ , $f = 1kHz$ , $4V_{p-p}$ , $R_L = 2k\Omega$		0.0002		%
		$G = 1$ , $f = 1kHz$ , $4V_{p-p}$ , $R_L = 600\Omega$		0.0003		%
$t_s$	Settling Time to 0.1% 4V Step; 10% to $V_{OUT}$	$A_V = 1$ , $V_{OUT} = 4V_{p-p}$ , $R_L = 2k\Omega$ to $V_{CM}$		0.4		$\mu s$
		$A_V = 1$ , $V_{OUT} = 4V_{p-p}$ , $R_L = 2k\Omega$ to $V_{CM}$		1		$\mu s$
<b>NOISE PERFORMANCE</b>						
$e_{n-p-p}$	Peak-to-Peak Input Voltage Noise	0.1Hz to 10Hz		580		nV $_{p-p}$
$e_n$	Input Voltage Noise Spectral Density	$f = 10Hz$		14		nV/ $\sqrt{Hz}$
		$f = 100Hz$		7		nV/ $\sqrt{Hz}$
		$f = 1kHz$		6		nV/ $\sqrt{Hz}$
		$f = 10kHz$		6		nV/ $\sqrt{Hz}$
$i_n$	Input Current Noise Spectral Density	$f = 1kHz$		9		fA/ $\sqrt{Hz}$
<b>OUTPUT CHARACTERISTICS</b>						
$V_{OL}$	Output Voltage Low, $V_{OUT}$ to $V_-$	$R_L = 10k\Omega$		0.8	1.0	V
					<b>1.1</b>	V
		$R_L = 2k\Omega$		0.9	1.1	V
					<b>1.2</b>	V
$V_{OH}$	Output Voltage High, $V_+$ to $V_{OUT}$	$R_L$ to GND = $10k\Omega$		0.8	1.0	V
					<b>1.1</b>	V
		$R_L$ to GND = $2k\Omega$		0.9	1.1	V
					<b>1.2</b>	V
$I_{SC}$	Output Short Circuit Current	$R_L = 10\Omega$ to $V_+$ . $V_-$		$\pm 50$		mA
<b>POWER SUPPLY</b>						
$V_{SUPPLY}$	Supply Voltage Range	Guaranteed by PSRR	<b><math>\pm 4.5</math></b>		<b><math>\pm 20V</math></b>	V
PSRR	Power Supply Rejection Ratio	$V_S = \pm 4.5V$ to $\pm 5V$	102	115		dB
			<b>100</b>			dB
$I_S$	Supply Current/Amplifier			2.5	2.9	mA
					<b>3.8</b>	mA

# ISL28110, ISL28210

**Electrical Specifications**  $V_S = \pm 15V$ ,  $V_{CM} = 0$ ,  $V_O = 0V$ ,  $T_A = +25^\circ C$ , unless otherwise noted. **Boldface limits apply over the operating temperature range,  $-40^\circ C$  to  $+125^\circ C$ .**

PARAMETER	DESCRIPTION	CONDITIONS	MIN (Note 8)	TYP	MAX (Note 8)	UNITS
<b>INPUT CHARACTERISTICS</b>						
$V_{OS}$	Input Offset Voltage		-300		300	$\mu V$
		$-40^\circ C \leq T_A \leq +125^\circ C$	<b>-1300</b>		<b>1300</b>	$\mu V$
$TCV_{OS}$	Input Offset Voltage Temperature Coefficient (Grade C)	$-40^\circ C \leq T_A \leq +125^\circ C$		<b>1</b>	<b>10</b>	$\mu V/C$
$I_B$	Input Bias Current (Note 9)		5	$\pm 2$	5	$\mu A$
		$-40^\circ C < T_A < +60^\circ C$	-350		350	$\mu A$
		$-40^\circ C < T_A < +85^\circ C$	-700		700	$\mu A$
		$-40^\circ C \leq T_A \leq +125^\circ C$	<b>-3600</b>		<b>3600</b>	$\mu A$
$I_{OS}$	Input Offset Current (Note 9)		-2.5	$\pm 0.5$	2.5	$\mu A$
		$-40^\circ C < T_A < +60^\circ C$	-285		285	$\mu A$
		$-40^\circ C < T_A < +85^\circ C$	-445		445	$\mu A$
		$-40^\circ C \leq T_A \leq +125^\circ C$	<b>-2000</b>		<b>2000</b>	$\mu A$
$C_{IN-DIFF}$	Differential Input Capacitance			8.3		$\mu F$
$C_{IN-CM}$	Common Mode Input Capacitance			11.8		$\mu F$
$R_{IN-DIFF}$	Differential Input Resistance			530		$\Omega$
$R_{IN-CM}$	Common Mode Input Resistance			560		$\Omega$
$V_{CMIR}$	Common Mode Input Voltage Range	Guaranteed by CMRR test	<b><math>V_- + 1.5</math></b>		<b><math>V_+ - 1.5</math></b>	V
CMRR	Common Mode Rejection Ratio	$V_{CM} = -13.5V$ to $+13.5V$	<b>80</b>	<b>100</b>		dB
$A_{VOL}$	Open-loop Gain	$R_L = 10k\Omega$ to ground $V_O = -12.5V$ to $+12.5V$	230	290		$V/mV$
		$-40^\circ C \leq T_A \leq +125^\circ C$	<b>200</b>			$V/mV$
<b>DYNAMIC PERFORMANCE</b>						
GBWP	Gain-bandwidth Product	$G = 100$ , $R_L = 100k\Omega$ , $C_L = 4pF$	11	12.5		MHz
SR	Slew Rate, $V_{OUT}$ 20% to 80%	$G = -1$ , $R_L = 2k\Omega$		23		$V/\mu s$
THD+N	Total Harmonic Distortion + Noise	$G = 1$ , $f = 1kHz$ , $10V_{P-P}$ , $R_L = 2k\Omega$		0.00025		%
		$G = 1$ , $f = 1kHz$ , $10V_{P-P}$ , $R_L = 600\Omega$		0.0003		%
$t_s$	Settling Time to 0.1% 10V Step; 10% to $V_{OUT}$	$A_V = 1$ , $V_{OUT} = 10V_{P-P}$ , $R_L = 2k\Omega$ to $V_{CM}$		0.9		$\mu s$
	Settling Time to 0.01% 10V Step; 10% to $V_{OUT}$	$A_V = 1$ , $V_{OUT} = 10V_{P-P}$ , $R_L = 2k\Omega$ to $V_{CM}$		1.2		$\mu s$
<b>NOISE PERFORMANCE</b>						
$e_{nP-P}$	Peak-to-Peak Input Voltage Noise	0.1Hz to 10Hz		600		$nV_{P-P}$
$e_n$	Input Voltage Noise Spectral Density	$f = 10Hz$		18		$nV/\sqrt{Hz}$
		$f = 100Hz$		7.8		$nV/\sqrt{Hz}$
		$f = 1kHz$		6		$nV/\sqrt{Hz}$
		$f = 10kHz$		6		$nV/\sqrt{Hz}$
$i_n$	Input Current Noise Spectral Density	$f = 1kHz$		9		$fA/\sqrt{Hz}$

# ISL28110, ISL28210

**Electrical Specifications**  $V_S = \pm 15V$ ,  $V_{CM} = 0$ ,  $V_O = 0V$ ,  $T_A = +25^\circ C$ , unless otherwise noted. **Boldface limits apply over the operating temperature range,  $-40^\circ C$  to  $+125^\circ C$ .** (Continued)

PARAMETER	DESCRIPTION	CONDITIONS	MIN (Note 8)	TYP	MAX (Note 8)	UNITS
<b>OUTPUT CHARACTERISTICS</b>						
$V_{OL}$	Output Voltage Low, $V_{OUT}$ to $V_-$	$R_L = 10k\Omega$		0.8	1.0	V
					<b>1.1</b>	V
		$R_L = 2k\Omega$		0.9	1.1	V
					<b>1.2</b>	V
$V_{OH}$	Output Voltage High, $V_+$ to $V_{OUT}$	$R_L$ to GND = $10k\Omega$		0.8	1.0	V
					<b>1.1</b>	V
		$R_L$ to GND = $2k\Omega$		0.9	1.1	V
					<b>1.2</b>	V
$I_{SC}$	Output Short Circuit Current	$R_L = 10\Omega$ to $V_+$ . $V_-$		$\pm 50$		mA
<b>POWER SUPPLY</b>						
PSRR	Power Supply Rejection Ratio	$V_S = \pm 4.5V$ to $\pm 20V$	102	115		dB
			<b>100</b>			dB
$I_S$	Supply Current/Amplifier			2.55	3.1	mA
					<b>3.9</b>	mA

NOTE:

- Parameters with MIN and/or MAX limits are 100% tested at  $+25^\circ C$ , unless otherwise specified. Temperature limits established by characterization and are not production tested.
- Limits established by characterization and are not production tested.

**Typical Performance Curves**  $V_S = \pm 15V$ ,  $V_{CM} = 0V$ ,  $R_L = \text{Open}$ ,  $T = +25^\circ C$ , unless otherwise specified.

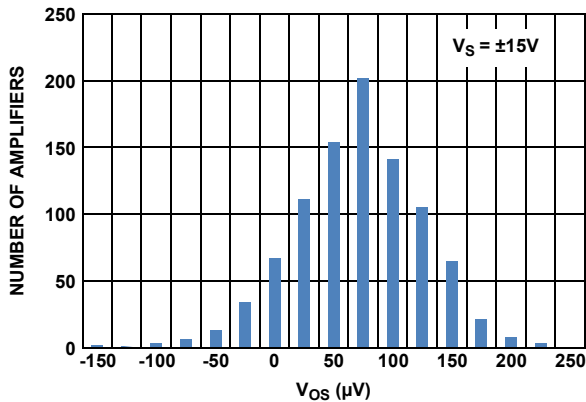

FIGURE 1. INPUT OFFSET VOLTAGE ( $V_{OS}$ ) DISTRIBUTION

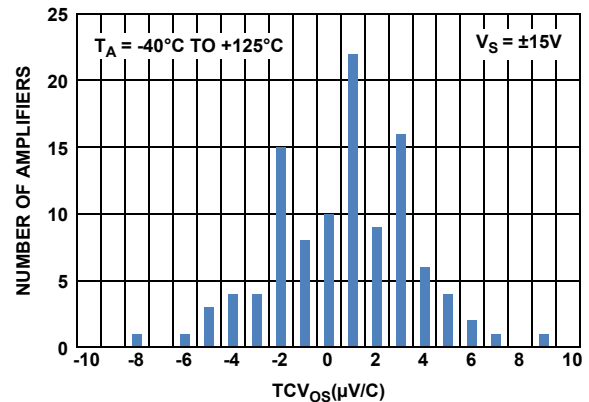

FIGURE 2.  $T_C V_{OS}$  DISTRIBUTION,  $-40^\circ C$  to  $+125^\circ C$

**Typical Performance Curves**  $V_S = \pm 15V$ ,  $V_{CM} = 0V$ ,  $R_L = \text{Open}$ ,  $T = +25^\circ C$ , unless otherwise specified. (Continued)

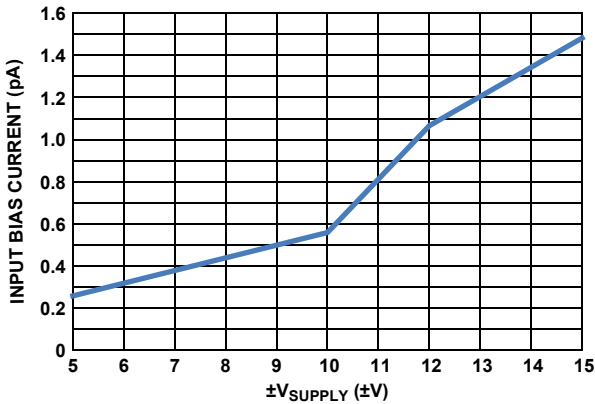

FIGURE 3. INPUT BIAS CURRENT ( $I_B$ ) vs SUPPLY VOLTAGE

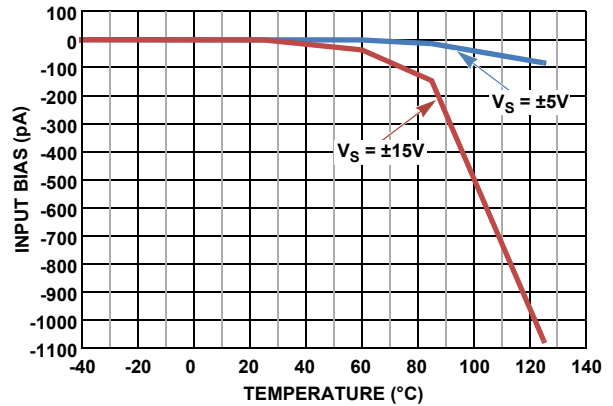

FIGURE 4. INPUT BIAS CURRENT ( $I_B$ ) vs TEMPERATURE

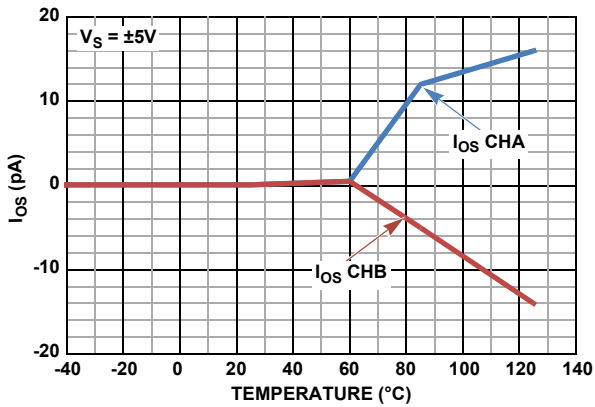

FIGURE 5. ISL28210 INPUT OFFSET CURRENT ( $I_{OS}$ ) vs TEMPERATURE,  $V_S = \pm 5V$

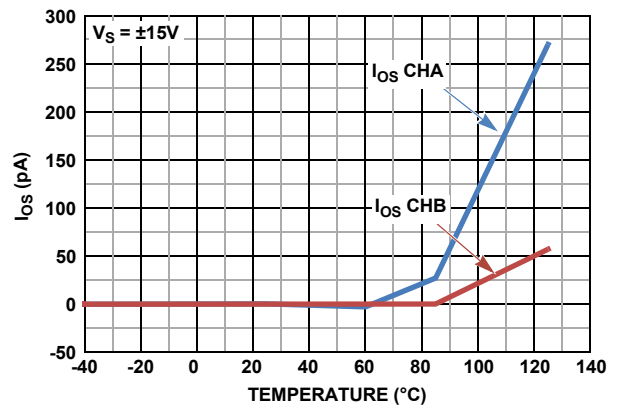

FIGURE 6. ISL28210 INPUT OFFSET CURRENT ( $I_{OS}$ ) vs TEMPERATURE,  $V_S = \pm 15V$

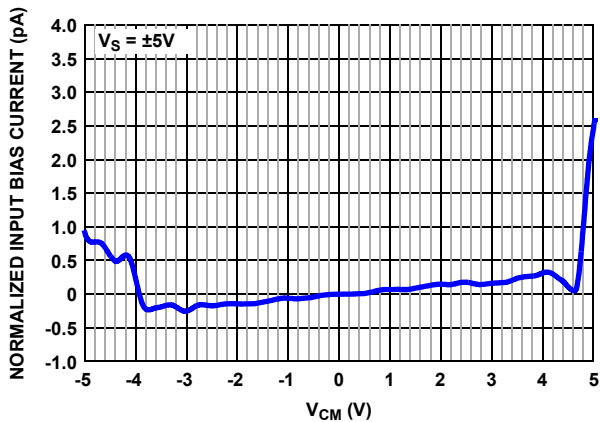

FIGURE 7. NORMALIZED INPUT BIAS CURRENT ( $I_B$ ) vs INPUT COMMON MODE VOLTAGE ( $V_{CM}$ ),  $V_S = \pm 5V$

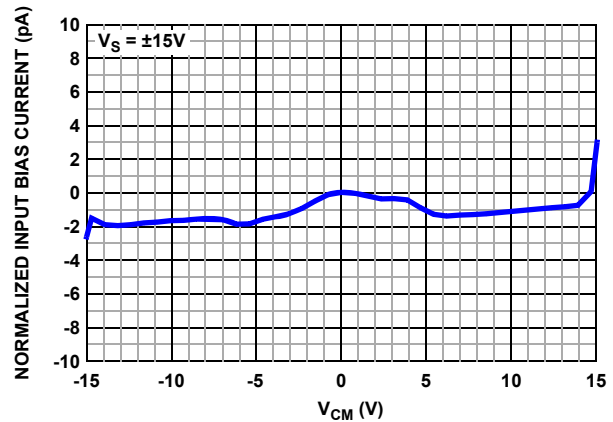

FIGURE 8. NORMALIZED INPUT BIAS CURRENT ( $I_B$ ) vs INPUT COMMON MODE VOLTAGE ( $V_{CM}$ ),  $V_S = \pm 15V$



Typical Performance Curves

$V_S = \pm 15V$ ,  $V_{CM} = 0V$ ,  $R_L = \text{Open}$ ,  $T = +25^\circ C$ , unless otherwise specified. (Continued)

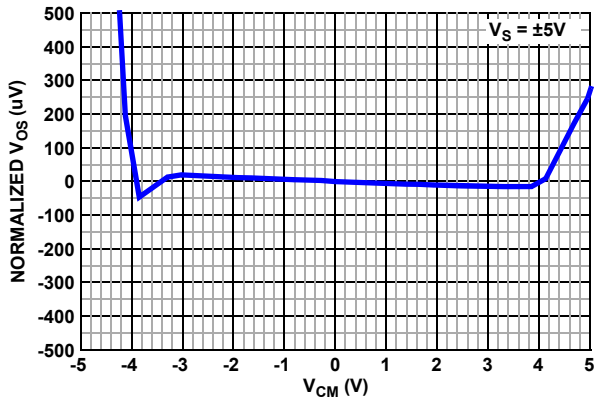

FIGURE 9. NORMALIZED INPUT OFFSET VOLTAGE ( $V_{OS}$ ) vs INPUT COMMON MODE VOLTAGE ( $V_{CM}$ ),  $V_S = \pm 5V$

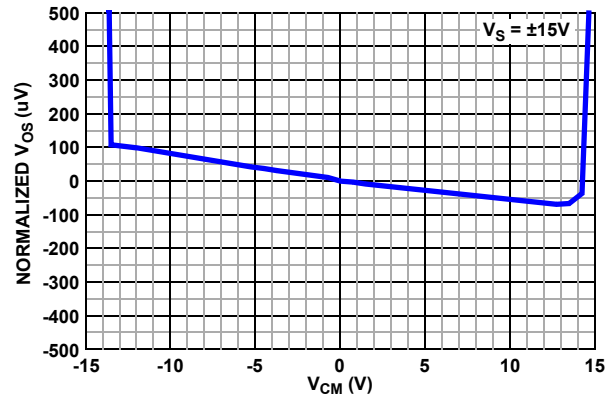

FIGURE 10. NORMALIZED INPUT OFFSET VOLTAGE ( $V_{OS}$ ) vs INPUT COMMON MODE VOLTAGE ( $V_{CM}$ ),  $V_S = \pm 15V$

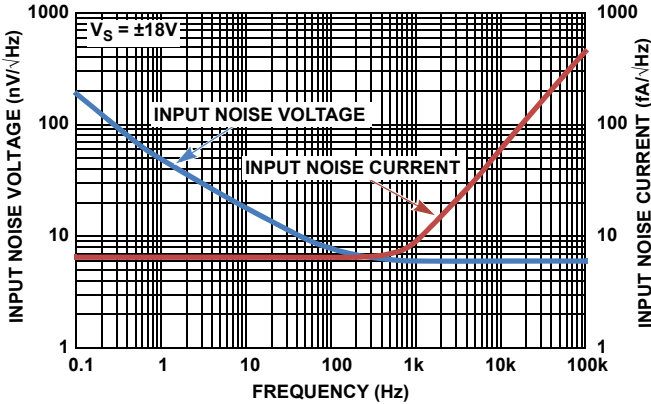

FIGURE 11. INPUT NOISE VOLTAGE ( $e_n$ ) AND CURRENT ( $i_n$ ) vs FREQUENCY,  $V_S = \pm 18V$

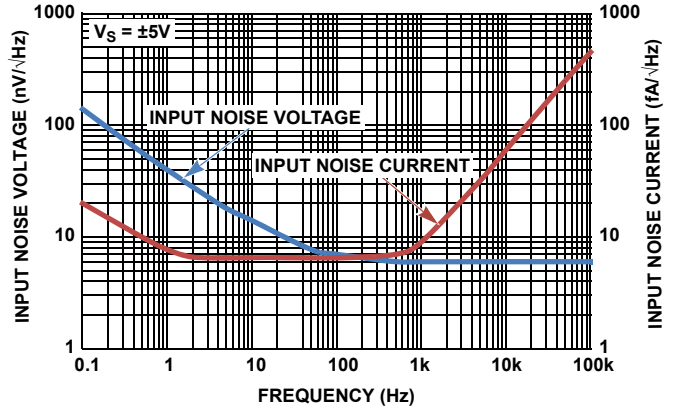

FIGURE 12. INPUT NOISE VOLTAGE ( $e_n$ ) AND CURRENT ( $i_n$ ) vs FREQUENCY,  $V_S = \pm 5V$

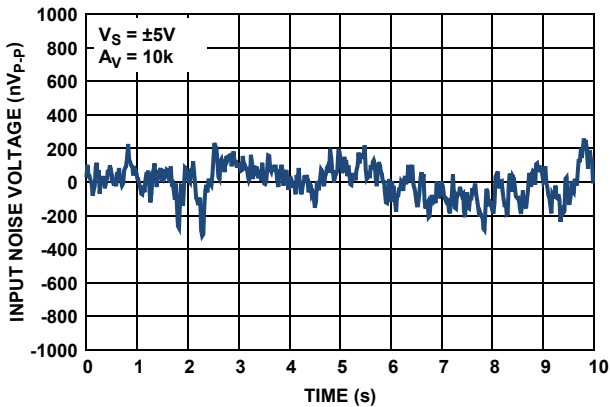

FIGURE 13. 0.1Hz TO 10Hz  $V_{P-P}$  NOISE VOLTAGE,  $V_S = \pm 5V$

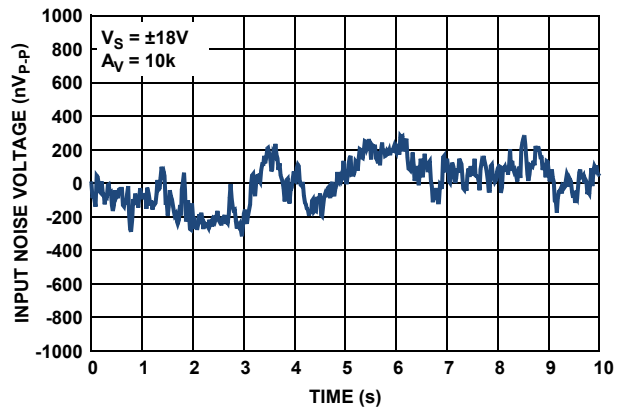

FIGURE 14. 0.1Hz TO 10Hz  $V_{P-P}$  NOISE VOLTAGE,  $V_S = \pm 18V$

**Typical Performance Curves**  $V_S = \pm 15V, V_{CM} = 0V, R_L = \text{Open}, T = +25^\circ C$ , unless otherwise specified. (Continued)

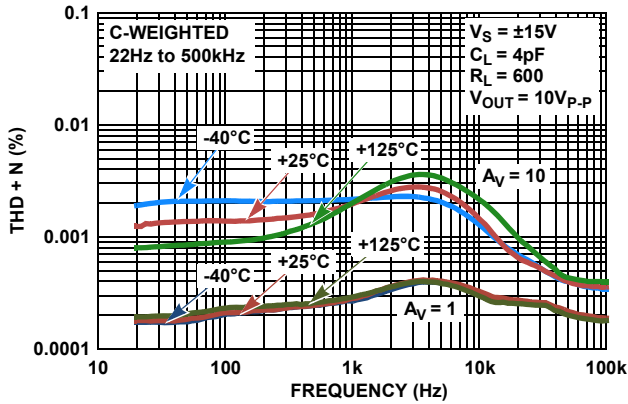

FIGURE 15. THD+N vs FREQUENCY vs TEMPERATURE,  $A_V = 1, 10, V_{OUT} = 10V_{P-P}, R_L = 600\Omega$

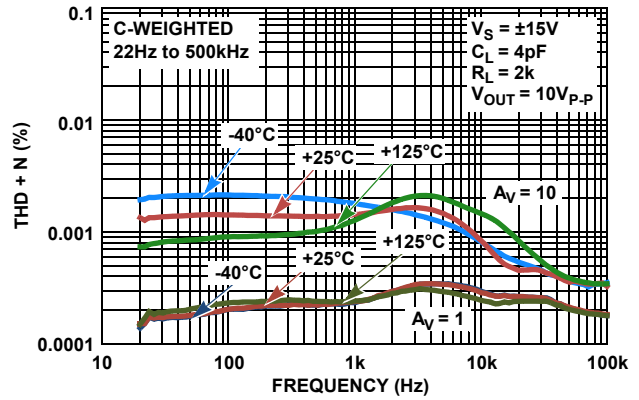

FIGURE 16. THD+N vs FREQUENCY vs TEMPERATURE,  $V_{OUT} = 10V_{P-P}, R_L = 2k\Omega$

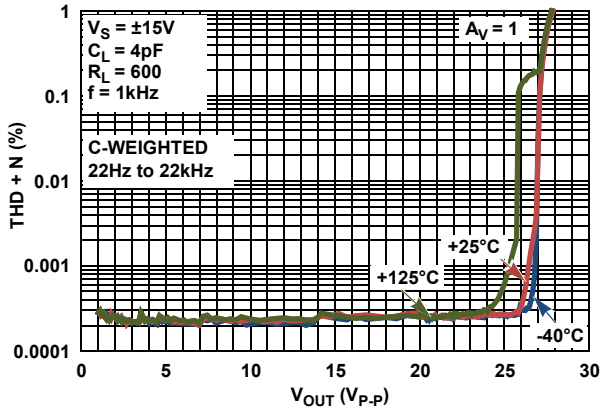

FIGURE 17. THD+N vs OUTPUT VOLTAGE ( $V_{OUT}$ ) vs TEMPERATURE,  $A_V = 1, f = 1kHz, R_L = 600\Omega$

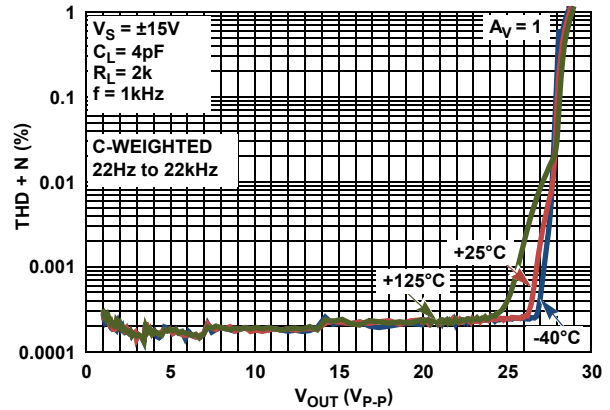

FIGURE 18. THD+N vs OUTPUT VOLTAGE ( $V_{OUT}$ ) vs TEMPERATURE,  $A_V = 1, f = 1kHz, R_L = 2k\Omega$

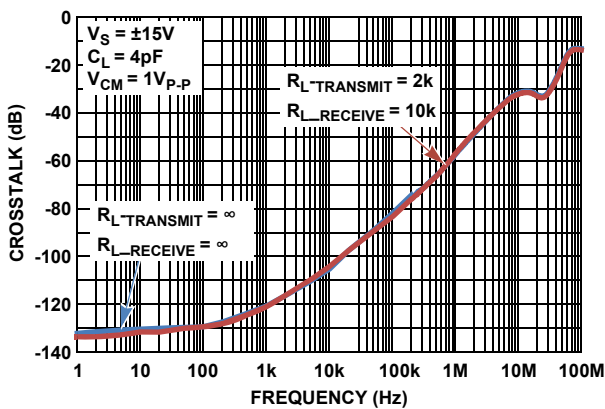

FIGURE 19. CROSSTALK vs FREQUENCY

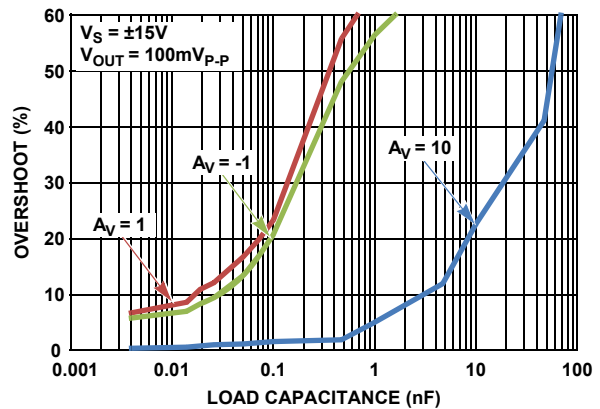

FIGURE 20. SMALL SIGNAL OVERSHOOT vs LOAD CAPACITANCE ( $C_L$ )

Typical Performance Curves

$V_S = \pm 15V$ ,  $V_{CM} = 0V$ ,  $R_L = \text{Open}$ ,  $T = +25^\circ C$ , unless otherwise specified. (Continued)

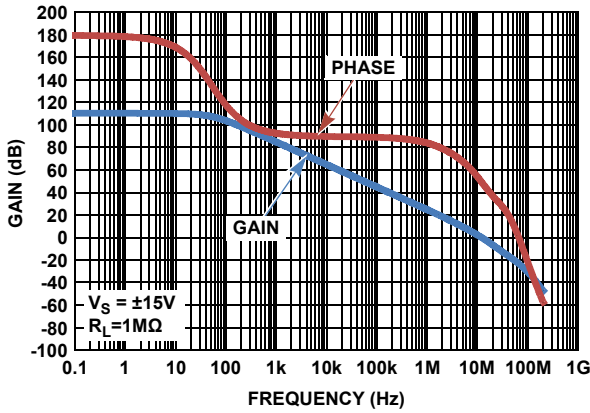

FIGURE 21. OPEN LOOP GAIN-PHASE vs FREQUENCY

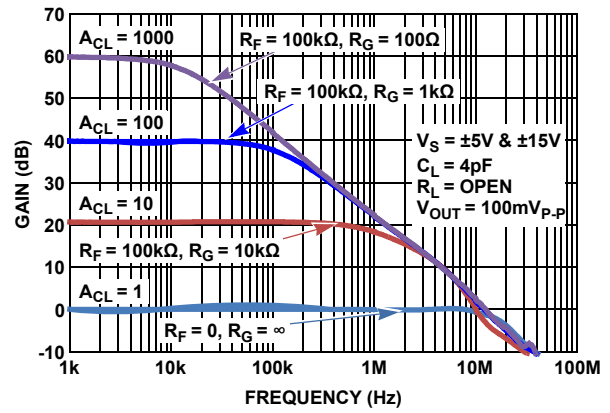

FIGURE 22. CLOSED LOOP GAIN vs FREQUENCY

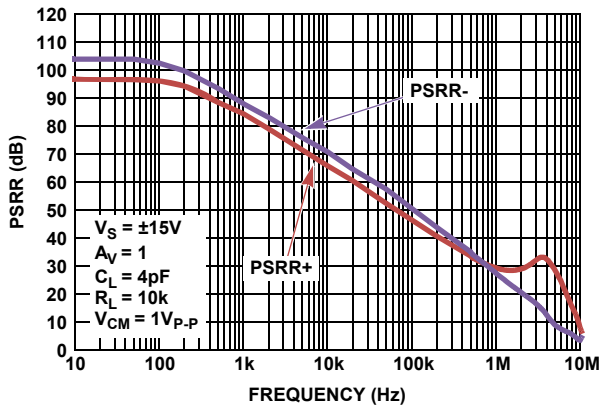

FIGURE 23. POWER SUPPLY REJECTION RATIO (PSRR) vs FREQUENCY

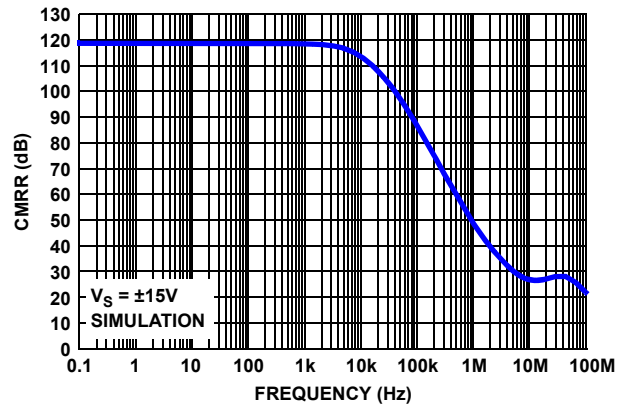

FIGURE 24. COMMON-MODE REJECTION RATIO (CMRR) vs FREQUENCY

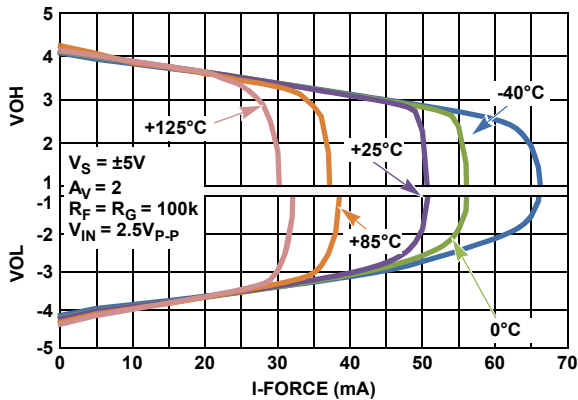

FIGURE 25. OUTPUT VOLTAGE ( $V_{OUT}$ ) vs OUTPUT CURRENT ( $I_{OUT}$ ) vs TEMPERATURE,  $V_S = \pm 5V$

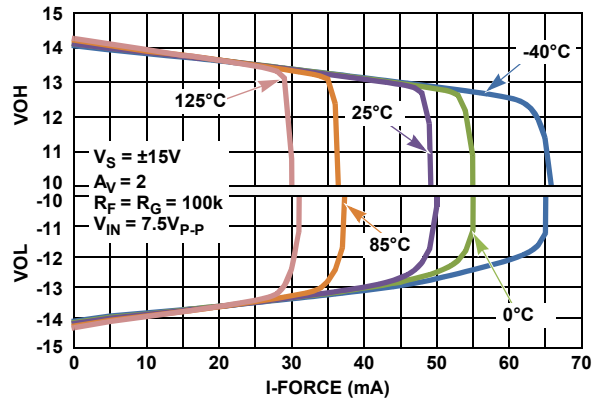

FIGURE 26. OUTPUT VOLTAGE ( $V_{OUT}$ ) vs OUTPUT CURRENT ( $I_{OUT}$ ) vs TEMPERATURE,  $V_S = \pm 15V$

Typical Performance Curves

$V_S = \pm 15V$ ,  $V_{CM} = 0V$ ,  $R_L = \text{Open}$ ,  $T = +25^\circ C$ , unless otherwise specified. (Continued)

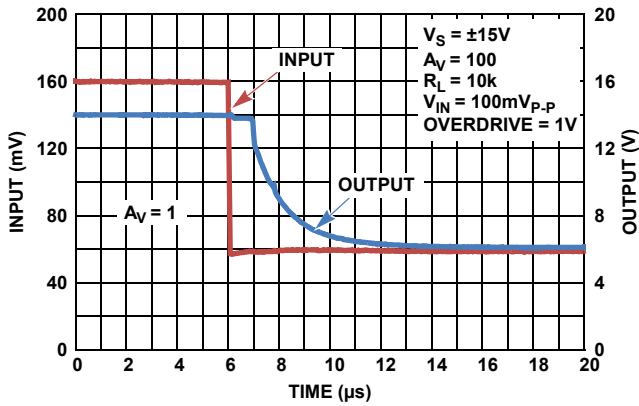

FIGURE 27. POSITIVE OUTPUT OVERLOAD RECOVERY TIME

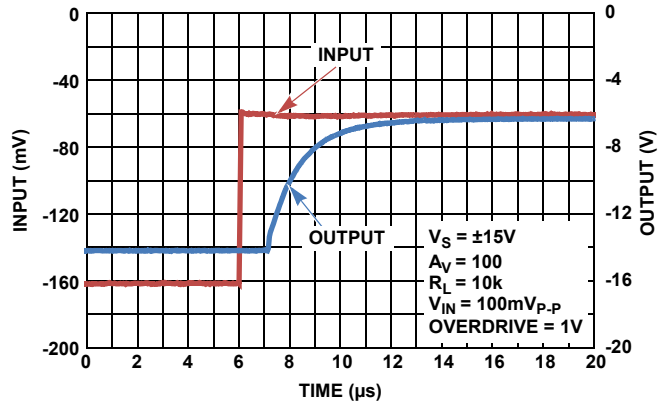

FIGURE 28. NEGATIVE OUTPUT OVERLOAD RECOVERY TIME

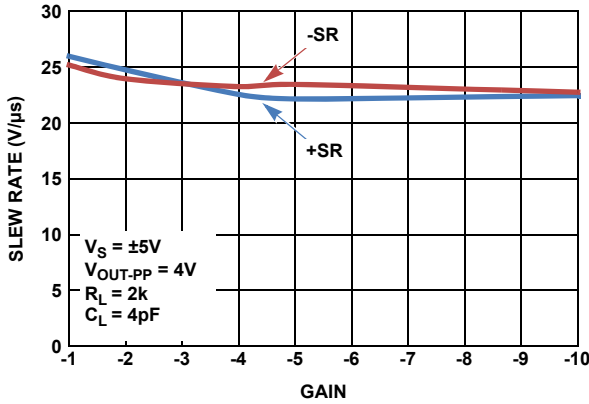

FIGURE 29. SLEW RATE vs INVERTING CLOSED LOOP GAIN,  $V_S = \pm 5V$

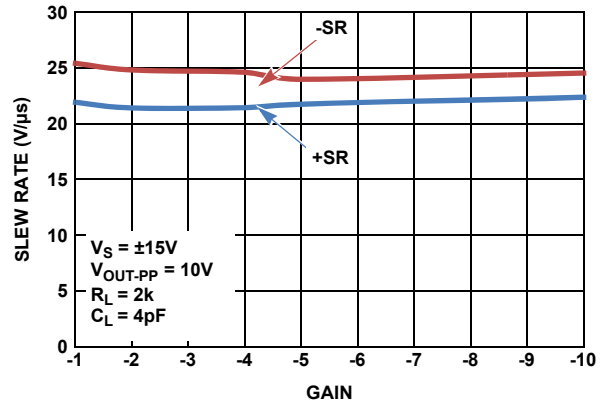

FIGURE 30. SLEW RATE vs INVERTING CLOSED LOOP GAIN,  $V_S = \pm 15V$

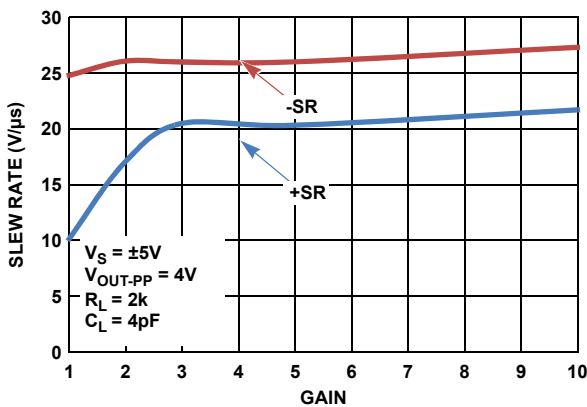

FIGURE 31. SLEW RATE vs NON-INVERTING CLOSED LOOP GAIN,  $V_S = \pm 5V$

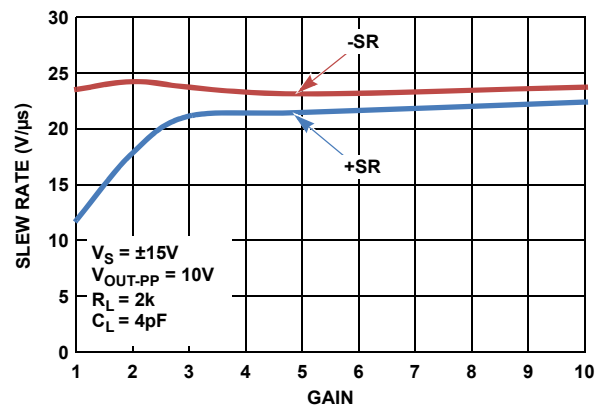

FIGURE 32. SLEW RATE vs NON-INVERTING CLOSED LOOP GAIN,  $V_S = \pm 15V$

**Typical Performance Curves**  $V_S = \pm 15V, V_{CM} = 0V, R_L = \text{Open}, T = +25^\circ C$ , unless otherwise specified. (Continued)

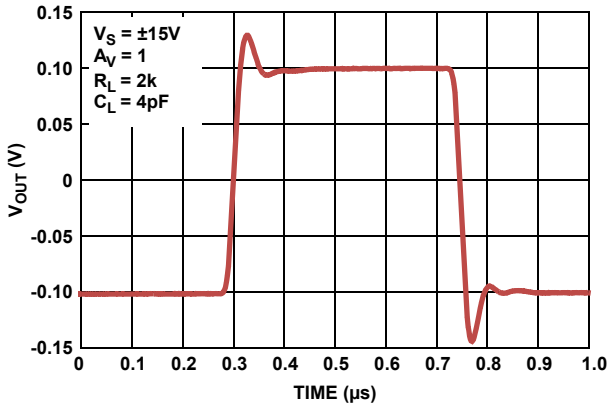

FIGURE 33. SMALL SIGNAL TRANSIENT RESPONSE

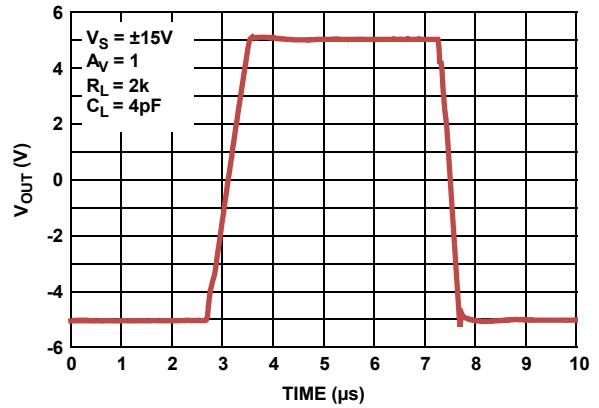

FIGURE 34. LARGE SIGNAL UNITY GAIN TRANSIENT RESPONSE

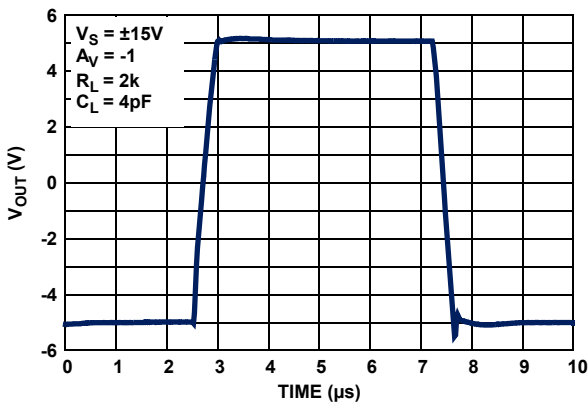

FIGURE 35. LARGE SIGNAL 10V STEP RESPONSE  $A_V = -1$

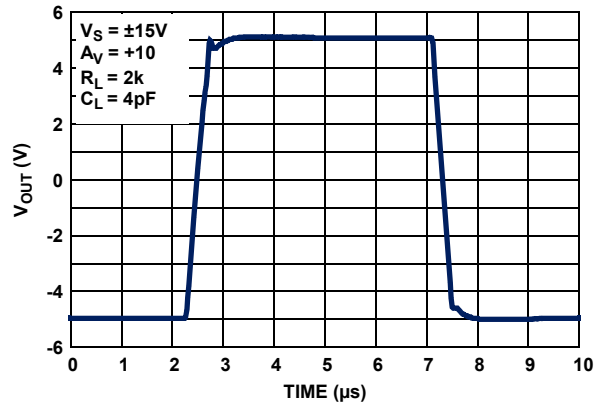

FIGURE 36. LARGE SIGNAL 10V STEP RESPONSE  $A_V = +10$

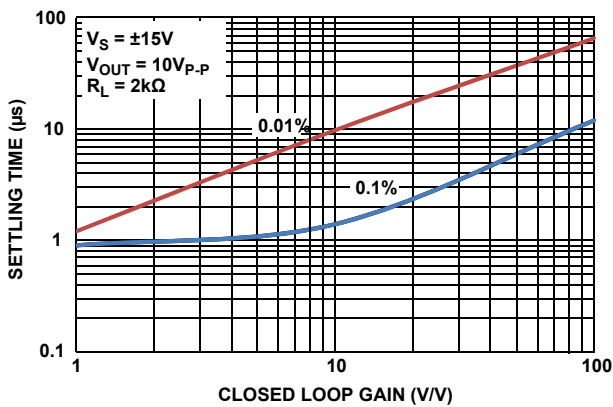

FIGURE 37. SETTLING TIME ( $t_s$ ) vs CLOSED LOOP GAIN

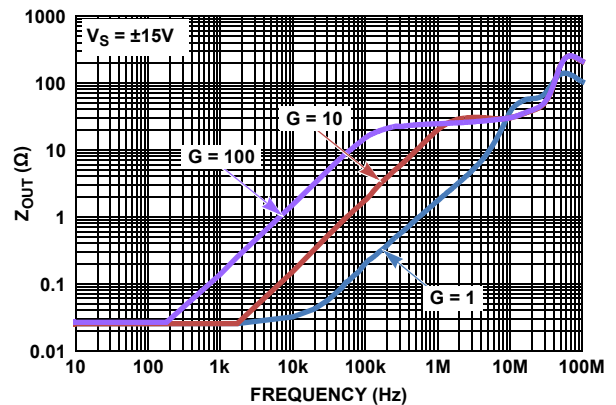

FIGURE 38.  $Z_{OUT}$  vs FREQUENCY

## Applications Information

### Functional Description

The ISL28110 and ISL28210 are single and dual 12.5 MHz precision JFET input op amps. These devices are fabricated in the PR40 Advanced SOI bipolar-JFET process to ensure latch-free operation. The precision JFET input stage provides low input offset voltage ( $300\mu\text{V}$  max @  $+25^\circ\text{C}$ ), low input voltage noise ( $6\text{nV}/\sqrt{\text{Hz}}$ ), and input current noise that is very low with virtually no  $1/f$  component. A high current complementary NPN/PNP emitter-follower output stage provides high slew rate and maintains excellent THD+N performance into heavy loads ( $0.0003\%$  @  $10\text{V}_{\text{p-p}}$  @  $1\text{kHz}$  into  $600\Omega$ ).

### Operating Voltage Range

The devices are designed to operate over the  $9\text{V}$  ( $\pm 4.5\text{V}$ ) to  $40\text{V}$  ( $\pm 20\text{V}$ ) range and are fully characterized at  $10\text{V}$  ( $\pm 5\text{V}$ ) and  $30\text{V}$  ( $\pm 15\text{V}$ ). The JFET input stage maintains high impedance over a maximum input differential voltage range of  $\pm 33\text{V}$ . Internal ESD protection diodes clamp the non-inverting and inverting inputs to one diode drop above and below the  $V+$  and  $V-$  the power supply rails ("Pin Descriptions" on page 2, CIRCUIT 1).

### Input ESD Diode Protection

The JFET gate is a reverse-biased diode with  $>33\text{V}$  reverse breakdown voltage which enables the device to function reliably in large signal pulse applications without the need for anti-parallel clamp diodes required on MOSFET and most bipolar input stage op amps. No special input signal restrictions are needed for power supply operation up to  $\pm 15\text{V}$ , and input signal distortion caused by nonlinear clamps under high slew rate conditions are avoided. For power supply operation greater than  $\pm 16\text{V}$  ( $>32\text{V}$ ), the internal ESD clamp diodes alone cannot clamp the maximum input differential signal to the power supply rails without the risk of exceeding the  $33\text{V}$  breakdown of the JFET gate. Under these conditions, differential input voltage limiting is necessary to prevent damage to the JFET input stage.

In applications where one or both amplifier input terminals are at risk of exposure to voltages beyond the supply rails, current limiting resistors may be needed at each input terminal (see Figure 39  $R_{\text{IN}+}$ ,  $R_{\text{IN}-}$ ) to limit current through the power supply ESD diodes to  $20\text{mA}$ .

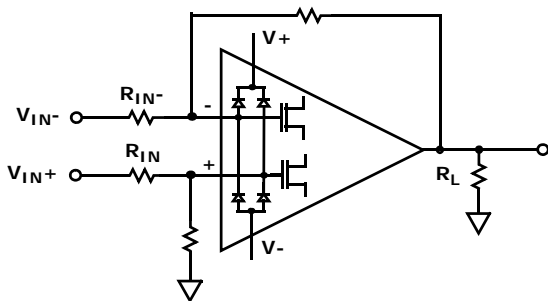

FIGURE 39. INPUT ESD DIODE CURRENT LIMITING

### JFET Input Stage Performance

The ISL28110, ISL28210 JFET input stage has the linear gain characteristics of the MOSFET but can operate at high frequency with much lower noise. The reversed-biased gate PN gate junction has significantly lower gate capacitance enabling input slew rates that rival op amps using bipolar input stages. The added advantage for high impedance, precision amplifiers is the lack of a significant  $1/f$  component of current noise (Figures 11, 12) as there is virtually no gate current.

The input stage JFETs are bootstrapped to maintain a constant JFET drain to source voltage which keeps the JFET gate currents and input stage frequency response nearly constant over the common mode input range of the device. These enhancements provide excellent CMRR, AC performance and very low input distortion over a wide temperature range. The common mode input performance for offset voltage and bias current is shown in FIGURE 40. Note that the input bias current remains low even after the maximum input stage common mode voltage is exceeded (as indicated by the abrupt change in input offset voltage).

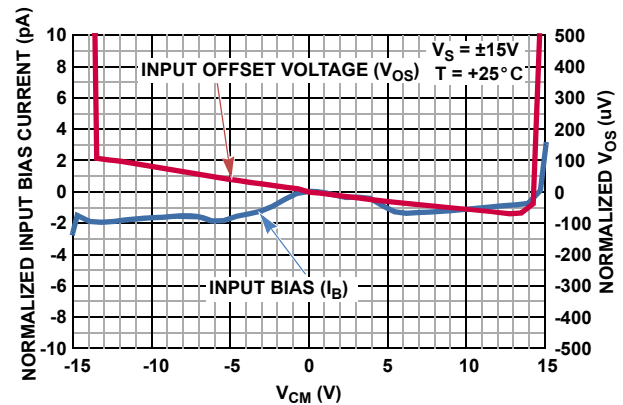

FIGURE 40. INPUT OFFSET VOLTAGE AND BIAS CURRENT vs COMMON MODE INPUT VOLTAGE

### Output Drive Capability

The complementary bipolar emitter follower output stage features low output impedance (Figure 40) and is capable of substantial current drive over the full temperature range (Figures 25, 26) while driving the output voltage close to the supply rails. The output current is internally limited to approximately  $\pm 50\text{mA}$  at  $+25^\circ\text{C}$ . The amplifiers can withstand a short circuit to either rail as long as the power dissipation limits are not exceeded. This applies to only 1 amplifier at a time for the dual op amp. Continuous operation under these conditions may degrade long term reliability.

### Output Phase Reversal

Output phase reversal is a change of polarity in the amplifier transfer function when the input voltage exceeds the supply voltage. The ISL28110 and ISL28210 are immune to output phase reversal, out to  $0.5\text{V}$  beyond the rail ( $V_{\text{ABS MAX}}$ ) limit. Beyond these limits, the device is still immune to reversal to  $1\text{V}$  beyond the

rails but damage to the internal ESD protection diodes can result unless these input currents are limited.

**Maximizing Dynamic Signal Range**

The amplifiers maximum undistorted output swing is a figure of merit for precision, low distortion applications. Audio amplifiers are a good example of amplifiers that require low noise and low signal distortion over a wide output dynamic range. When these applications operate from batteries, raising the amplifier supply voltage to overcome poor output voltage swing has the penalty of increased power consumption and shorter battery life. Amplifiers whose input and output stages can swing closest to the power supply rails while providing low noise and undistorted performance, will provide maximum useful dynamic signal range and longer battery life.

Rail-to-rail input and output (RRIO) amplifiers have the highest dynamic signal range but their added complexity degrades input noise and amplifier distortion. Many contain two input pairs, one pair operating to each supply rail. The trade-offs for these are increased input noise and distortion caused by non-linear input bias current and capacitance when amplifying high impedance sources. Their rail-to-rail output stages swing to within a few millivolts of the rail, but output impedances are high so that their output swing decreases and distortion increases rapidly with increasing load current. At heavy load currents the maximum output voltage swing of RRO op amps can be lower than a good emitter follower output stage.

The ISL28110 and ISL28210 low noise input stage and high performance output stage are optimized for low THD+N into moderate loads over the full -40°C to +125°C temperature range. Figures 17 and 18 show the 1kHz THD+N unity gain performance vs output voltage swing at load resistances of 2kΩ and 600Ω. Figure 41 shows the unity-gain THD+N performance driving 600Ω from ±5V supplies.

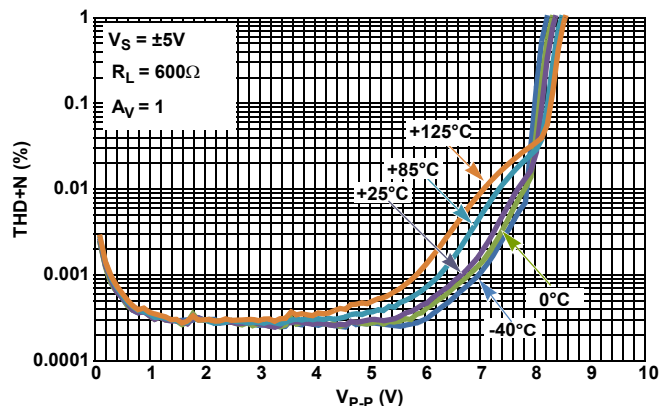

**FIGURE 41. UNITY-GAIN THD+N vs OUTPUT VOLTAGE vs TEMPERATURE AT V<sub>S</sub> = ±5V FOR 600Ω LOAD**

**Power Dissipation**

It is possible to exceed the +150°C maximum junction temperatures under certain load and power supply conditions. It is therefore important to calculate the maximum junction temperature (T<sub>JMAX</sub>) for all applications to determine if power supply voltages, load conditions, or package type need to be modified to remain in the safe operating area. These parameters are related using Equation 1:

$$T_{JMAX} = T_{MAX} + \theta_{JA} \times PD_{MAXTOTAL} \tag{EQ. 1}$$

where:

- PD<sub>MAXTOTAL</sub> is the sum of the maximum power dissipation of each amplifier in the package (PD<sub>MAX</sub>)
- PD<sub>MAX</sub> for each amplifier can be calculated using Equation 2:

$$PD_{MAX} = V_S \times I_{qMAX} + (V_S - V_{OUTMAX}) \times \frac{V_{OUTMAX}}{R_L} \tag{EQ. 2}$$

where:

- T<sub>MAX</sub> = Maximum ambient temperature
- θ<sub>JA</sub> = Thermal resistance of the package
- PD<sub>MAX</sub> = Maximum power dissipation of 1 amplifier
- V<sub>S</sub> = Total supply voltage
- I<sub>qMAX</sub> = Maximum quiescent supply current of 1 amplifier
- V<sub>OUTMAX</sub> = Maximum output voltage swing of the application
- R<sub>L</sub> = Load resistance

## Revision History

The revision history provided is for informational purposes only and is believed to be accurate, but not warranted. Please go to web to make sure you have the latest Rev.

DATE	REVISION	CHANGE
9/13/10	FN6639.0	Initial Release.

## Products

Intersil Corporation is a leader in the design and manufacture of high-performance analog semiconductors. The Company's products address some of the industry's fastest growing markets, such as, flat panel displays, cell phones, handheld products, and notebooks. Intersil's product families address power management and analog signal processing functions. Go to [www.intersil.com/products](http://www.intersil.com/products) for a complete list of Intersil product families.

\*For a complete listing of Applications, Related Documentation and Related Parts, please see the respective device information page on intersil.com: [ISL28110](http://www.intersil.com/products), [ISL28210](http://www.intersil.com/products)

To report errors or suggestions for this datasheet, please go to [www.intersil.com/askourstaff](http://www.intersil.com/askourstaff)

FITs are available from our website at <http://rel.intersil.com/reports/search.php>

---

For additional products, see [www.intersil.com/product\\_tree](http://www.intersil.com/product_tree)

Intersil products are manufactured, assembled and tested utilizing ISO9000 quality systems as noted in the quality certifications found at [www.intersil.com/design/quality](http://www.intersil.com/design/quality)

*Intersil products are sold by description only. Intersil Corporation reserves the right to make changes in circuit design, software and/or specifications at any time without notice. Accordingly, the reader is cautioned to verify that data sheets are current before placing orders. Information furnished by Intersil is believed to be accurate and reliable. However, no responsibility is assumed by Intersil or its subsidiaries for its use; nor for any infringements of patents or other rights of third parties which may result from its use. No license is granted by implication or otherwise under any patent or patent rights of Intersil or its subsidiaries.*

For information regarding Intersil Corporation and its products, see [www.intersil.com](http://www.intersil.com)



# Package Outline Drawing

## L8.3x3A

8 LEAD THIN DUAL FLAT NO-LEAD PLASTIC PACKAGE

Rev 4, 2/10

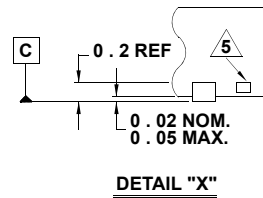
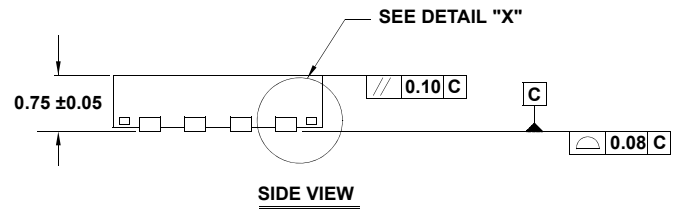
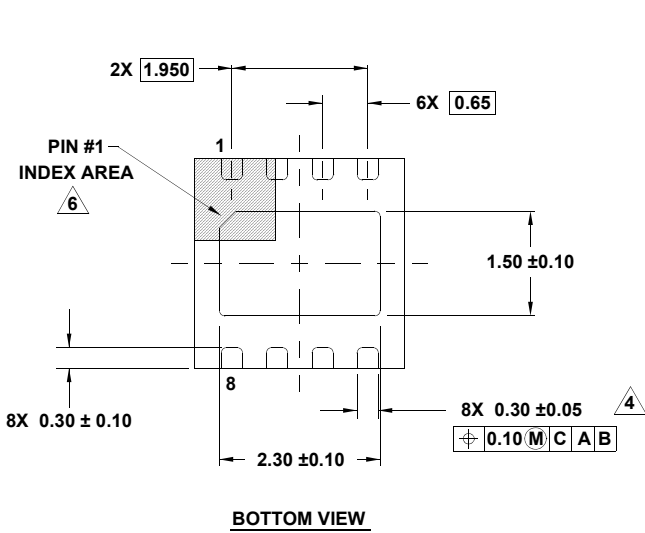
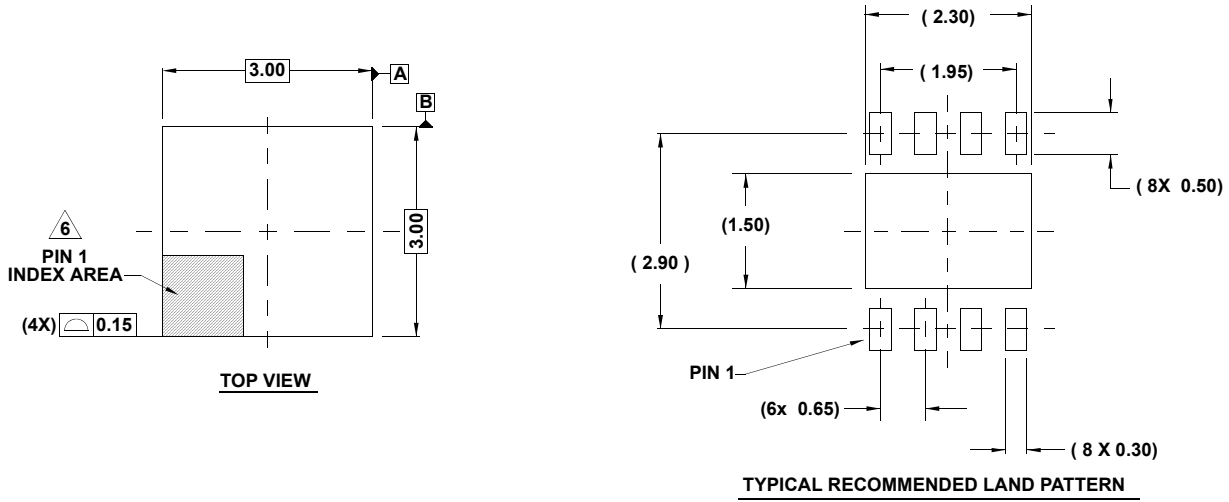

**NOTES:**

1. Dimensions are in millimeters.  
Dimensions in ( ) for Reference Only.
2. Dimensioning and tolerancing conform to ASME Y14.5m-1994.
3. Unless otherwise specified, tolerance : Decimal  $\pm 0.05$
4. Dimension applies to the metallized terminal and is measured between 0.15mm and 0.20mm from the terminal tip.
5. Tiebar shown (if present) is a non-functional feature.
6. The configuration of the pin #1 identifier is optional, but must be located within the zone indicated. The pin #1 identifier may be either a mold or mark feature.
7. Compliant to JEDEC MO-229 WEEC-2 except for the foot length.

# Package Outline Drawing

## M8.118

8 LEAD MINI SMALL OUTLINE PLASTIC PACKAGE

Rev 3, 3/10

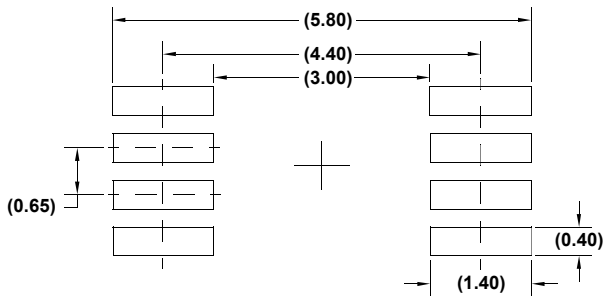
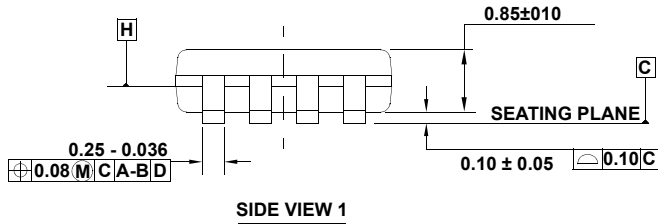
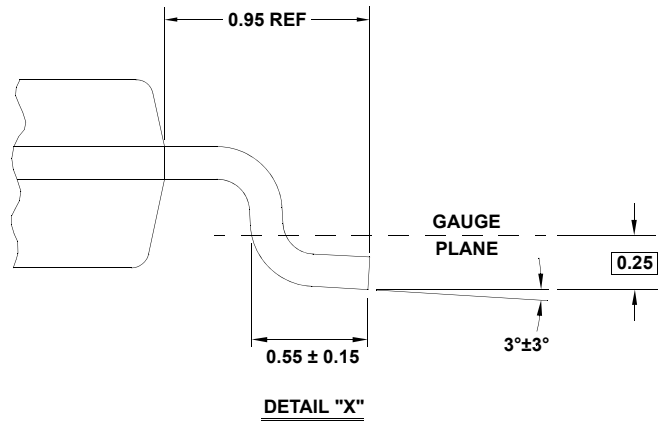
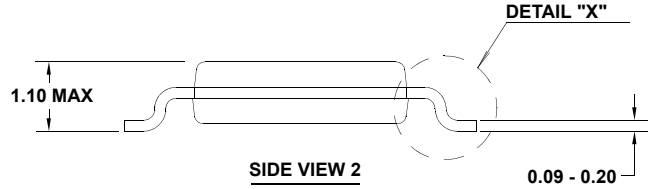
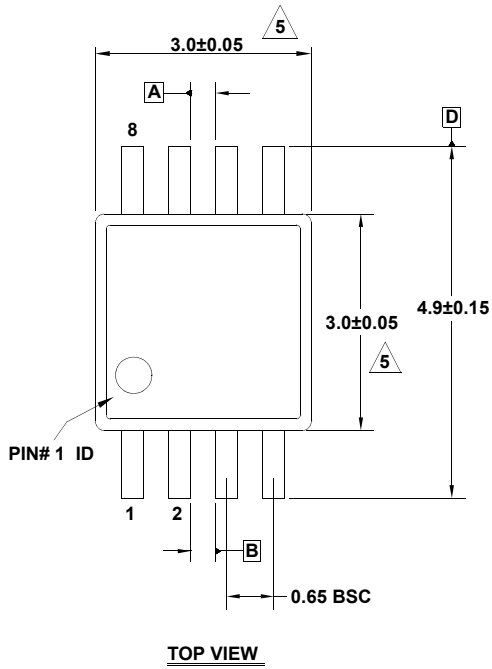

**NOTES:**

1. Dimensions are in millimeters.
2. Dimensioning and tolerancing conform to JEDEC MO-187-AA and AMSEY14.5m-1994.
3. Plastic or metal protrusions of 0.15mm max per side are not included.
4. Plastic interlead protrusions of 0.15mm max per side are not included.
5. Dimensions are measured at Datum Plane "H".
6. Dimensions in ( ) are for reference only.

# Package Outline Drawing

## M8.15E

8 LEAD NARROW BODY SMALL OUTLINE PLASTIC PACKAGE

Rev 0, 08/09

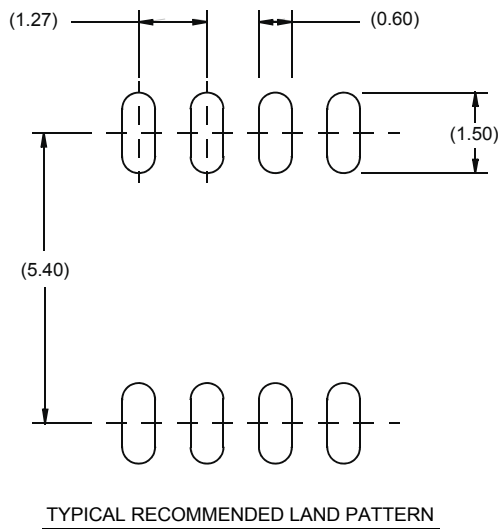
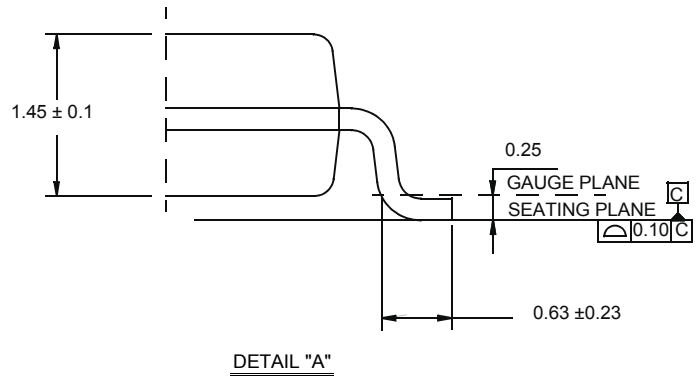
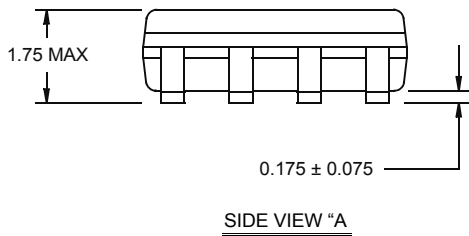
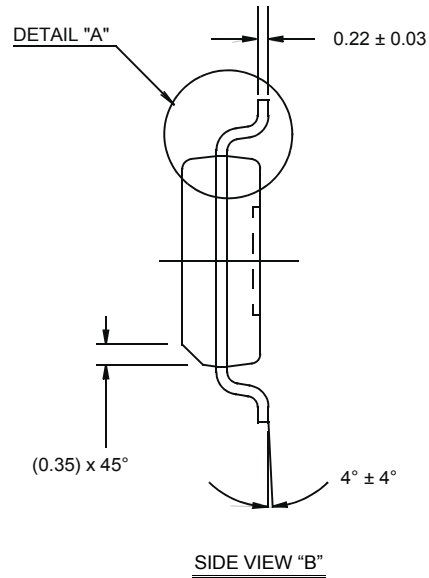
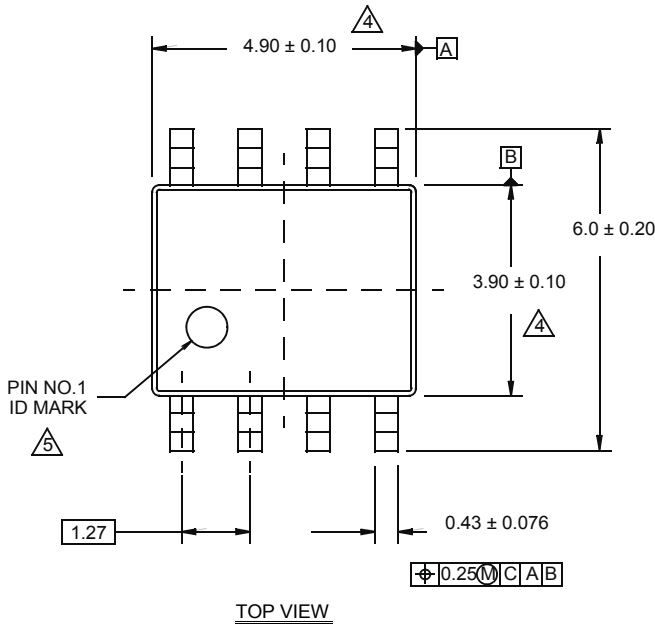

**NOTES:**

1. Dimensions are in millimeters.  
Dimensions in ( ) for Reference Only.
2. Dimensioning and tolerancing conform to AMSE Y14.5m-1994.
3. Unless otherwise specified, tolerance : Decimal ± 0.05
4. Dimension does not include interlead flash or protrusions.  
Interlead flash or protrusions shall not exceed 0.25mm per side.
5. The pin #1 identifier may be either a mold or mark feature.
6. Reference to JEDEC MS-012.