

Specification

Description

The AC-Power series is designed for high current operation and high flux output applications.

It incorporates state of the art COB design and low thermal resistant material.

The AC Power LED is ideal light sources for general illumination applications, custom designed solutions, and high performance lights.



A8

Features

- Super high Flux output and high Luminance
- Designed for high current operation
- Lead Free product
- RoHS compliant

Applications

- Architectural lighting
- Down light
- Task lighting
- Decorative / Pathway lighting

* The appearance and specifications of the product can be changed for improvement without notice.

Outline dimensions

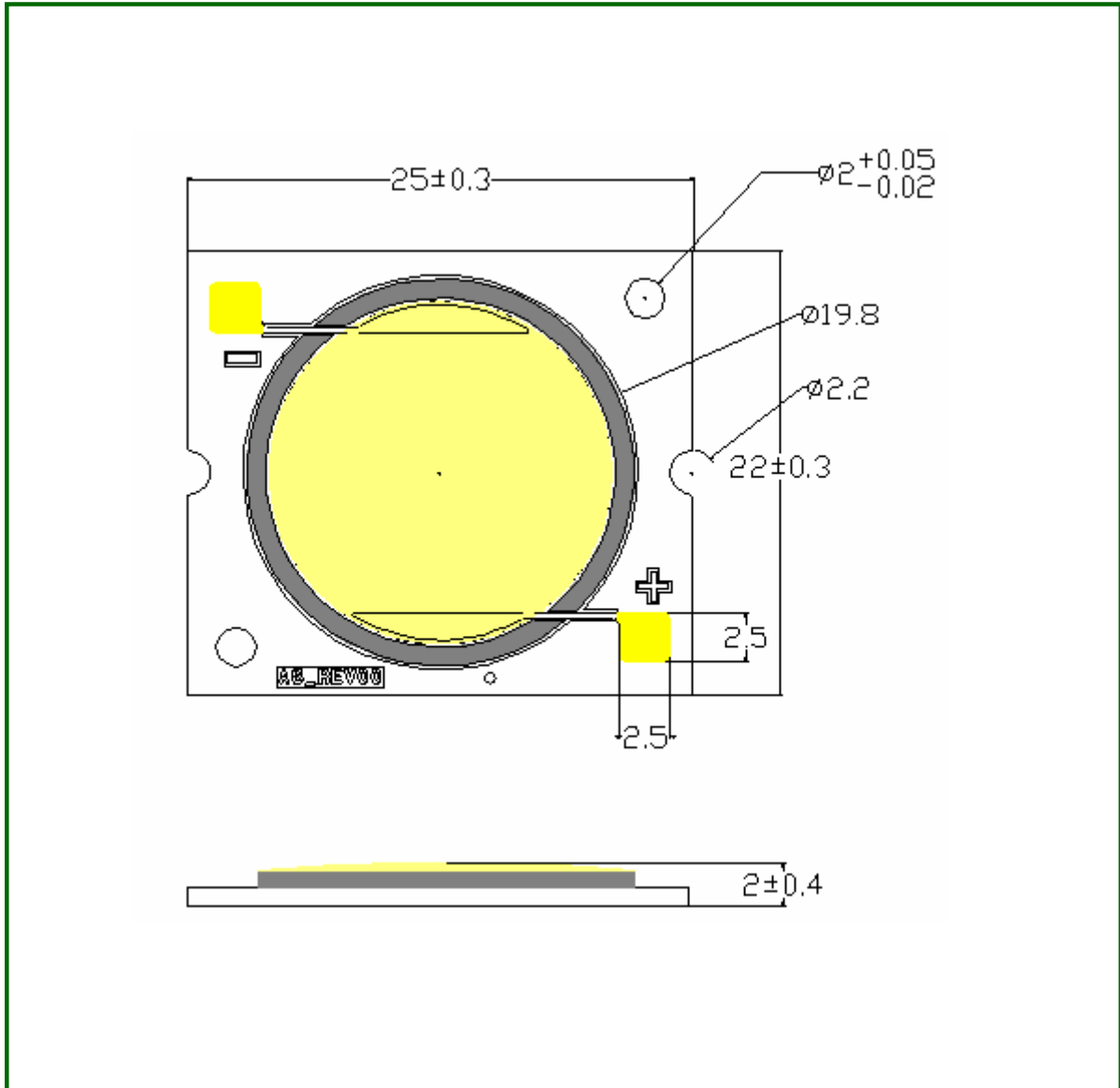

Notes :

- [1] All dimensions are in millimeters.
- [2] Scale : none
- [3] Undefined tolerance is ± 0.2 mm

Characteristics of A8(Part no : SAWW8F1A)

1. Warm white

1-1 Electro-Optical characteristics at 10W(LED emitter's power)

Parameter	Symbol	Value			Unit
		Min	Typ	Max	
Luminous Flux ^[1]	Φ_V ^[2]		800		lm
Correlated Color Temperature ^[3]	CCT	-	3000	-	K
CRI	R _a	80	-	-	-
Forward Current (RMS)	I _F		120		mA
Forward Voltage ^[4] (RMS)	V _F		120		V
Thermal resistance (J to s) ^[6]	R Θ_{J-s}		1		K/W
View Angle	2 Θ 1/2		120		deg.

1-2 Absolute Maximum Ratings

Parameter	Symbol	Value	Unit
Voltage (RMS)	V _F	130	V
LED Power Dissipation ^[5] (RMS)	P _d	13	W
Junction Temperature	T _j	125	°C
Operating Temperature ^[7]	T _{opr}	-40 ~ +85	°C
Storage Temperature	T _{stg}	-40 ~ +100	°C
ESD Sensitivity (HBM)	-	±10	kV

*Notes :

- [1] SSC maintains a tolerance of ±10% on flux and power measurements.
- [2] Φ_V is the total luminous flux output as measured with an integrating sphere.
- [3] Correlated Color Temperature is derived from the CIE 1931 Chromaticity diagram.
CCT ±5% tolerance.
- [4] Tolerance is ±10V on forward voltage measurements
- [5] Power Dissipation is LED emitter's consumption excluding the power resistor.
The LED emitter's 10W coincides with 12~13W.
See pp10.
- [6] At thermal Resistance, J to S means junction to COB's metal pcb bottom.
- [7] Operating temperature is ambient temperature.

Characteristics of A8(Part no : SAWW8D1A)

1. Warm white

1-1 Electro-Optical characteristics at 10W(LED emitter's power)

Parameter	Symbol	Value			Unit
		Min	Typ	Max	
Luminous Flux ^[1]	Φ_V ^[2]		800		lm
Correlated Color Temperature ^[3]	CCT	-	3000	-	K
CRI	R _a	80	-	-	-
Forward Current (RMS)	I _F		60		mA
Forward Voltage ^[4] (RMS)	V _F		220		V
Thermal resistance (J to s) ^[6]	R Θ_{J-s}		1		K/W
View Angle	2 Θ 1/2		120		deg.

1-2 Absolute Maximum Ratings

Parameter	Symbol	Value	Unit
Voltage (RMS)	V _F	250	V
LED Power Dissipation ^[5] (RMS)	P _d	13	W
Junction Temperature	T _j	125	°C
Operating Temperature ^[7]	T _{opr}	-40 ~ +85	°C
Storage Temperature	T _{stg}	-40 ~ +100	°C
ESD Sensitivity (HBM)	-	±10	kV

*Notes :

- [1] SSC maintains a tolerance of ±10% on flux and power measurements.
- [2] Φ_V is the total luminous flux output as measured with an integrating sphere.
- [3] Correlated Color Temperature is derived from the CIE 1931 Chromaticity diagram.
CCT ±5% tolerance.
- [4] Tolerance is ±10V on forward voltage measurements
- [5] Power Dissipation is LED emitter's consumption excluding the power resistor.
The LED emitter's 10W coincides with 12~13W.
See pp10
- [6] At thermal Resistance, J to S means junction to COB's metal pcb bottom.
- [7] Operating temperature is ambient.

Color Spectrum

VF=120V, IF=120mA, Ta=25°C

VF=220V, IF=60mA, Ta=25°C

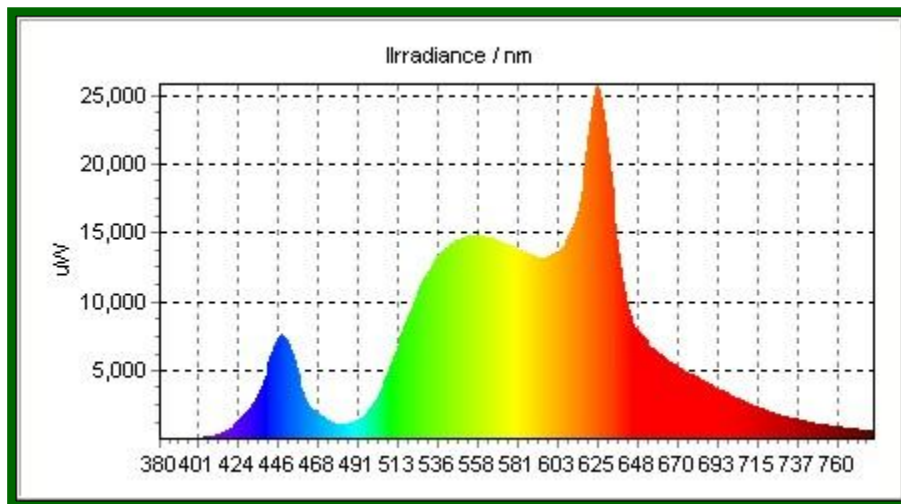

Forward Current Characteristics

Forward Current vs. Luminous Flux, VF= 120V, IF=120mA, Ta=25°C

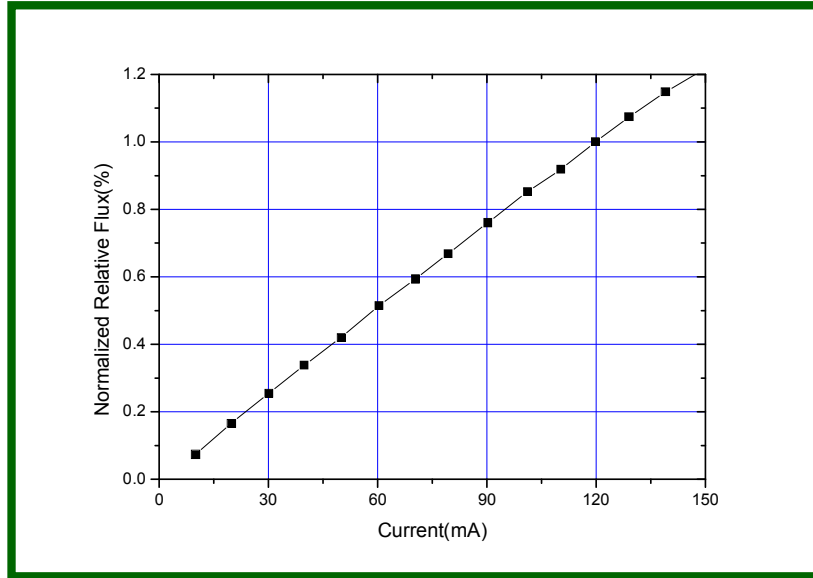

Forward Current vs. Luminous Flux, VF= 220V, IF=60mA, Ta=25°C

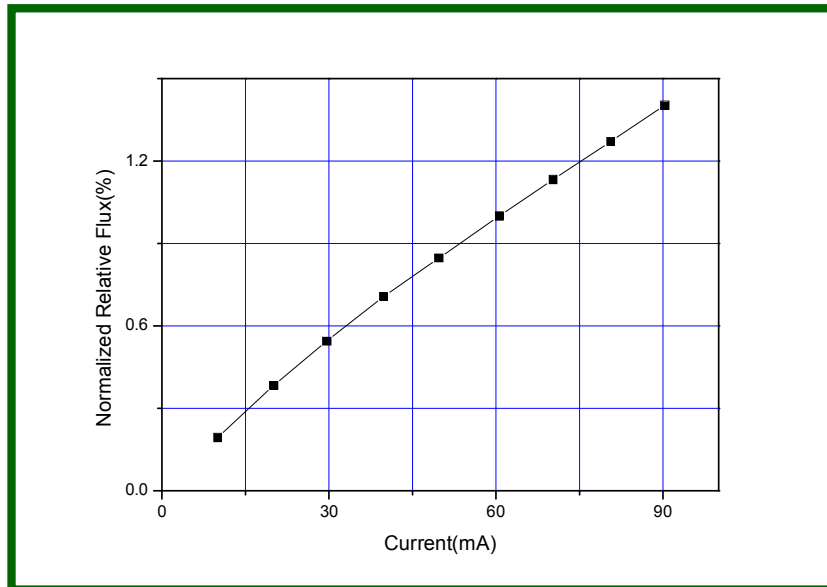

CCT vs. Junction Temperature(25~140℃)
VF=120V, IF=120mA and VF=220V, IF=60mA

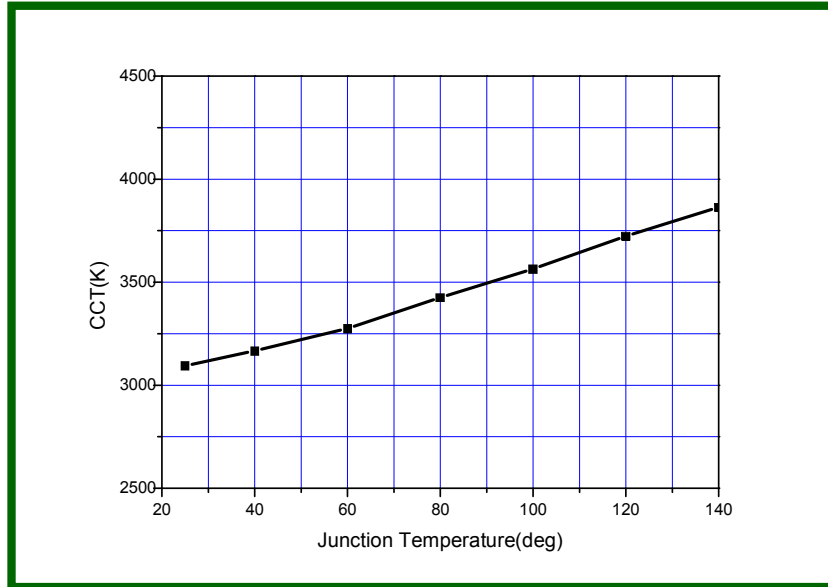

Temperature vs. Normalized Relative Luminous Flux
VF=120V, IF=120mA and VF=220V, IF=60mA

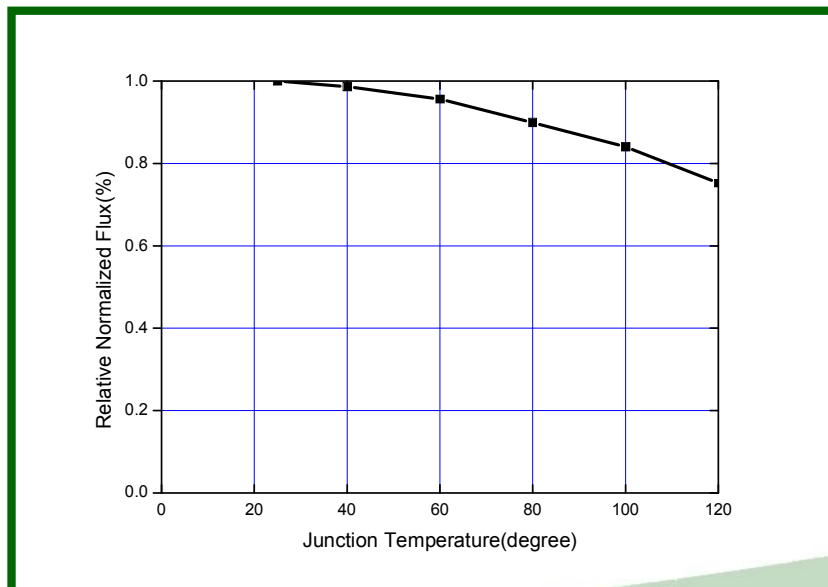

Forward Voltage vs. Luminous Flux, VF=120V, IF=120mA, Ta=25°C

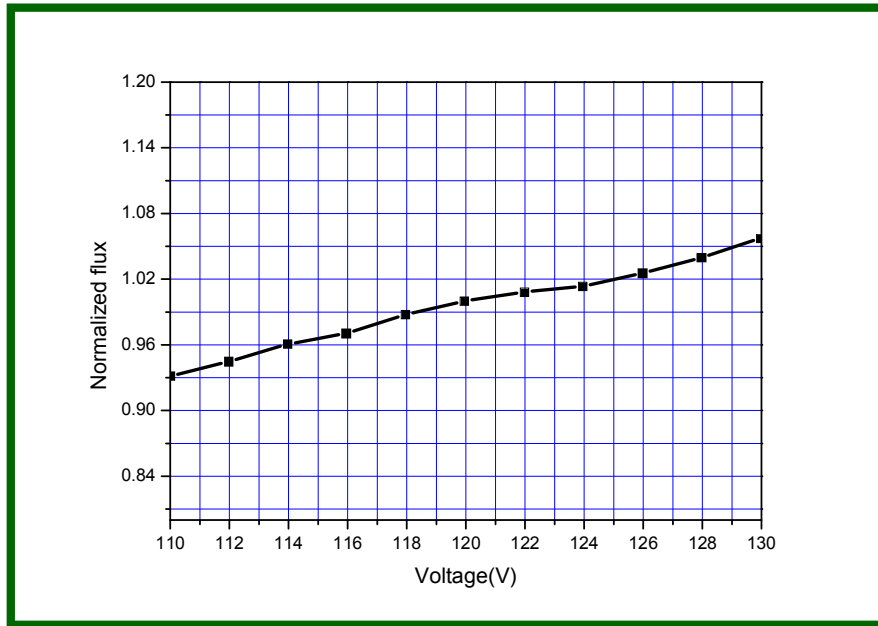

Forward Voltage vs. Luminous Flux, VF=220V, IF=60mA, Ta=25°C

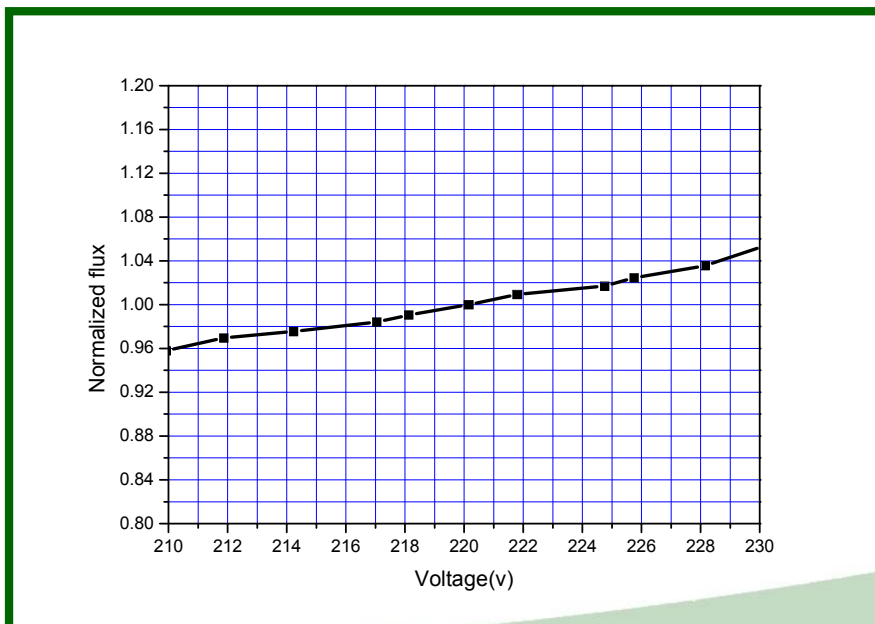

Radiation pattern

VF=120V, IF=120mA, Ta=25°C

VF=220V, IF=60mA, Ta=25°C

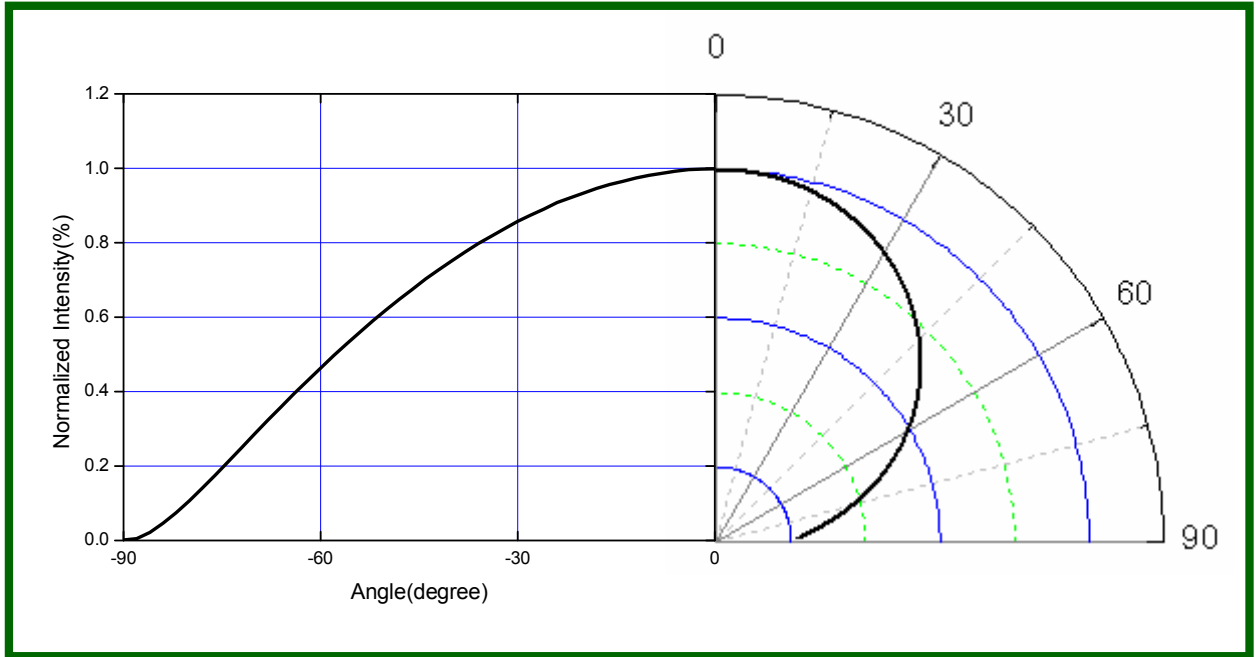

Binning Structure

VF=120V, IF=120mA, Ta=25°C

VF=220V, IF=60mA, Ta=25°C

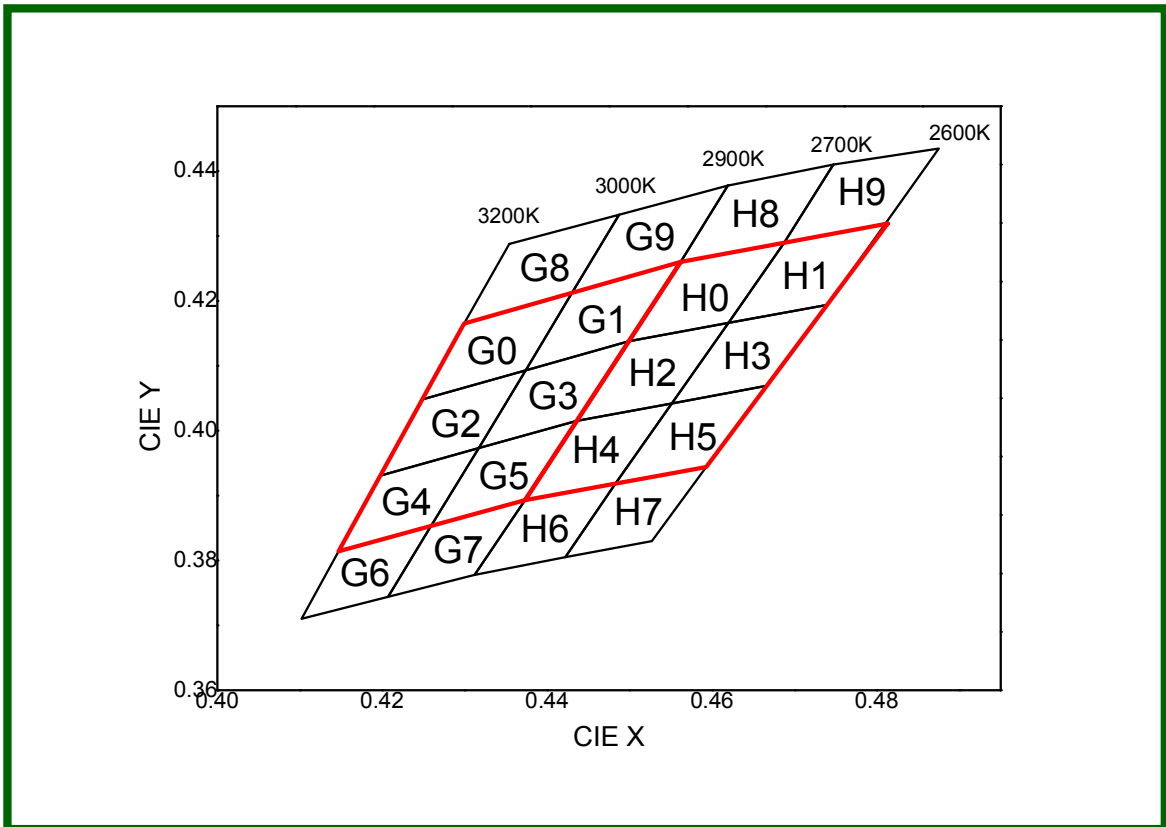

*** Note**

Red area is ANSI chromaticity.

VF=120V, IF=120mA, Ta=25°C

VF=220V, IF=60mA, Ta=25°C

● COLOR RANK

	CIE X	CIE Y			CIE X	CIE Y
G8	0.4354	0.4288		H8	0.4619	0.4378
	0.4299	0.4165			0.4562	0.4260
	0.4430	0.4212			0.4687	0.4289
	0.4487	0.4333			0.4747	0.4410
G0	0.4354	0.4288		H0	0.4619	0.4378
	0.4299	0.4165			0.4562	0.4260
	0.4430	0.4212			0.4687	0.4289
	0.4487	0.4333			0.4562	0.4260
G2	0.4248	0.4048		H2	0.4499	0.4138
	0.4374	0.4093			0.4436	0.4015
	0.4430	0.4212			0.4551	0.4042
	0.4299	0.4165			0.4620	0.4166
G4	0.4248	0.4048		H4	0.4499	0.4138
	0.4198	0.3931			0.4436	0.4015
	0.4317	0.3973			0.4551	0.4042
	0.4374	0.4093			0.4620	0.4166
G6	0.4248	0.4048		H6	0.4499	0.4138
	0.4198	0.3931			0.4436	0.4015
	0.4317	0.3973			0.4551	0.4042
	0.4374	0.4093			0.4620	0.4166
G9	0.4147	0.3814		H9	0.4499	0.4138
	0.4259	0.3853			0.4436	0.4015
	0.4317	0.3973			0.4551	0.4042
	0.4198	0.3931			0.4620	0.4166
G1	0.4147	0.3814		H1	0.4373	0.3893
	0.4102	0.3710			0.4483	0.3919
	0.4207	0.3744			0.4551	0.4042
	0.4259	0.3853			0.4436	0.4015
G3	0.4147	0.3814		H3	0.4373	0.3893
	0.4430	0.4212			0.4312	0.3778
	0.4562	0.4260			0.4422	0.3805
	0.4487	0.4333			0.4483	0.3919
G5	0.4430	0.4212		H5	0.4687	0.4289
	0.4374	0.4093			0.4810	0.4319
	0.4499	0.4138			0.4875	0.4435
	0.4562	0.4260			0.4747	0.4410
G7	0.4430	0.4212		H7	0.4687	0.4289
	0.4374	0.4093			0.4620	0.4166
	0.4499	0.4138			0.4551	0.4042
	0.4562	0.4260			0.4666	0.4069
G8	0.4374	0.4093		H8	0.4740	0.4194
	0.4317	0.3973			0.4810	0.4319
	0.4436	0.4015			0.4687	0.4289
	0.4499	0.4138			0.4620	0.4166
G0	0.4317	0.3973		H0	0.4551	0.4042
	0.4436	0.4015			0.4666	0.4069
	0.4499	0.4138			0.4740	0.4194
	0.4374	0.4093			0.4620	0.4166
G2	0.4317	0.3973		H2	0.4551	0.4042
	0.4259	0.3853			0.4593	0.3944
	0.4373	0.3893			0.4666	0.4069
	0.4436	0.4015			0.4551	0.4042
G4	0.4317	0.3973		H4	0.4551	0.4042
	0.4259	0.3853			0.4483	0.3919
	0.4373	0.3893			0.4422	0.3805
	0.4436	0.4015			0.4527	0.3830
G6	0.4259	0.3853		H6	0.4593	0.3944
	0.4207	0.3744			0.4483	0.3919
	0.4312	0.3778			0.4422	0.3805
	0.4373	0.3893			0.4527	0.3830
G9	0.4259	0.3853		H9	0.4593	0.3944
	0.4430	0.4212			0.4483	0.3919
	0.4562	0.4260			0.4422	0.3805
	0.4487	0.4333			0.4527	0.3830
G1	0.4430	0.4212		H1	0.4593	0.3944
	0.4374	0.4093			0.4483	0.3919
	0.4499	0.4138			0.4422	0.3805
	0.4562	0.4260			0.4527	0.3830
G3	0.4430	0.4212		H3	0.4483	0.3919
	0.4374	0.4093			0.4422	0.3805
	0.4499	0.4138			0.4527	0.3830
	0.4562	0.4260			0.4483	0.3919
G5	0.4317	0.3973		H5	0.4422	0.3805
	0.4259	0.3853			0.4527	0.3830
	0.4373	0.3893			0.4593	0.3944
	0.4436	0.4015			0.4483	0.3919
G7	0.4317	0.3973		H7	0.4527	0.3830
	0.4259	0.3853			0.4593	0.3944
	0.4207	0.3744			0.4483	0.3919
	0.4312	0.3778			0.4422	0.3805
G8	0.4373	0.3893		H8	0.4527	0.3830
	0.4373	0.3893			0.4593	0.3944
	0.4259	0.3853			0.4483	0.3919
	0.4259	0.3853			0.4422	0.3805

Luminous Flux Rank

Rank	LF [lm]	Condition
B1	570~630	120V 120mA (SAWW8F1A)
B2	630~700	
C	700~800	

Rank	LF [lm]	Condition
B1	570~630	220V 60mA (SAWW8D1A)
B2	630~700	
C	700~800	

Voltage Rank

Rank	VF [V]	Model
F	117.5~120.5	SAWW8F1A
G	120.5~124.5	
H	124.5~127.5	
I	127.5~131.5	

Rank	VF [V]	Model
J	224~230	SAWW8D1A
K	230~240	
L	240~250	
M	250~260	

Test Circuit

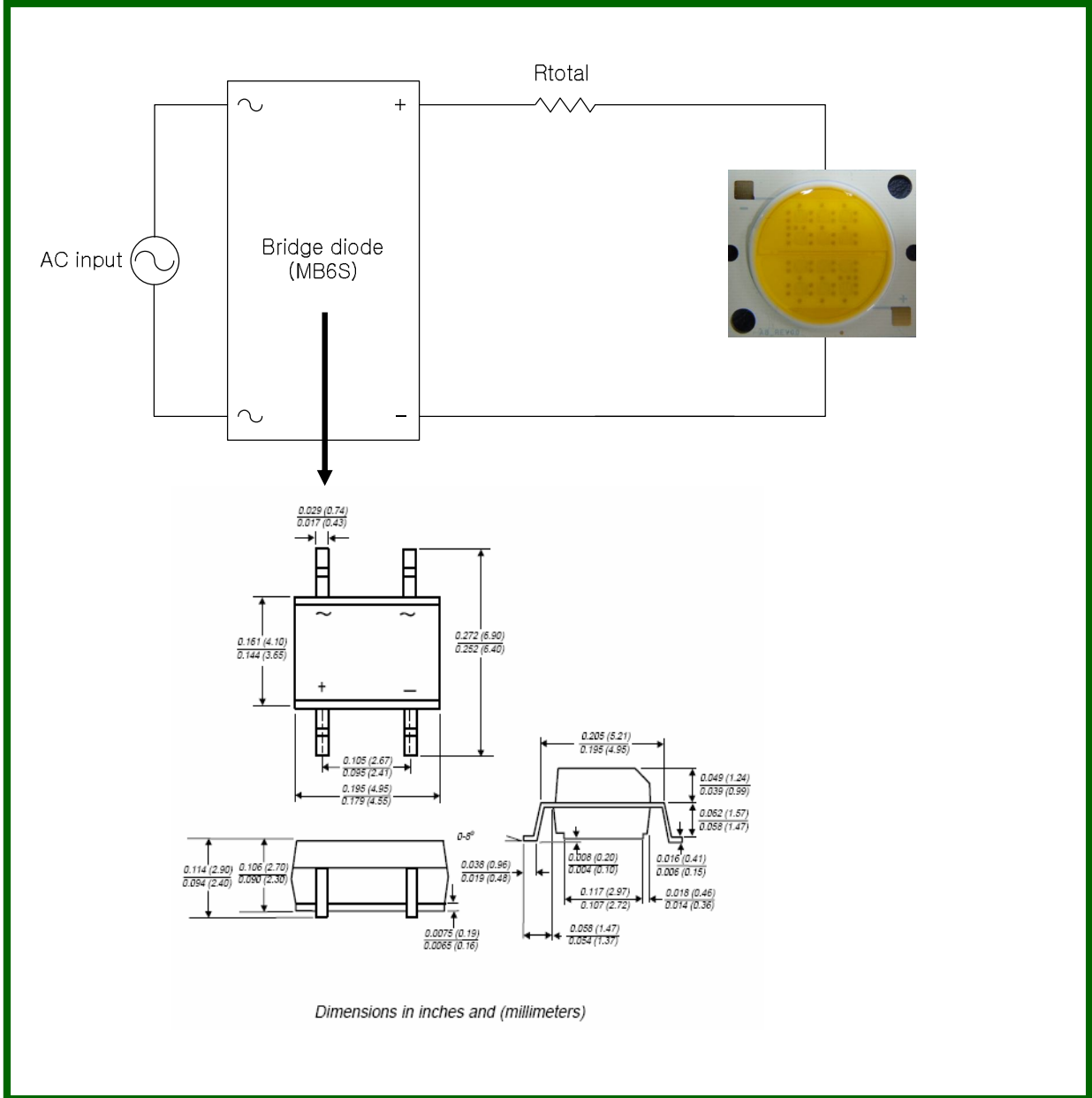

Mechanical Connection to Heat sink

< Top View >

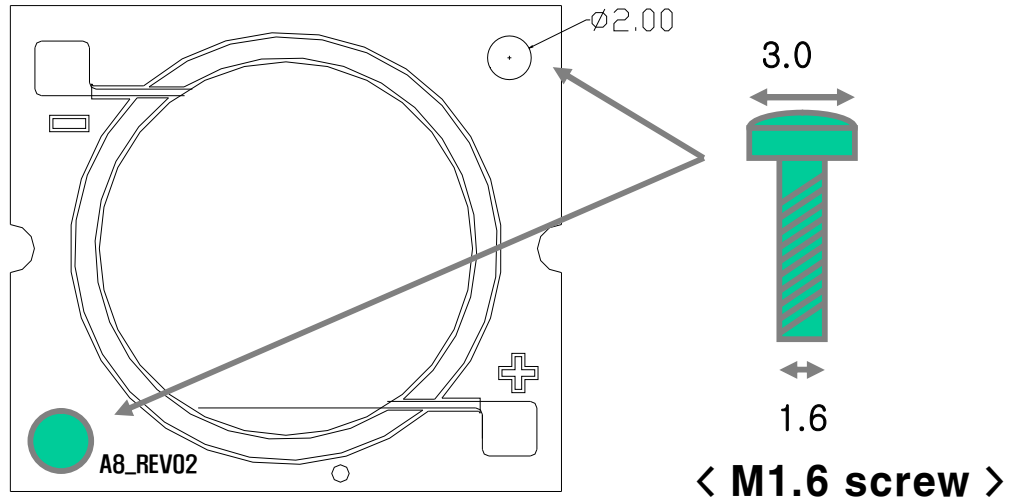

< Side View >

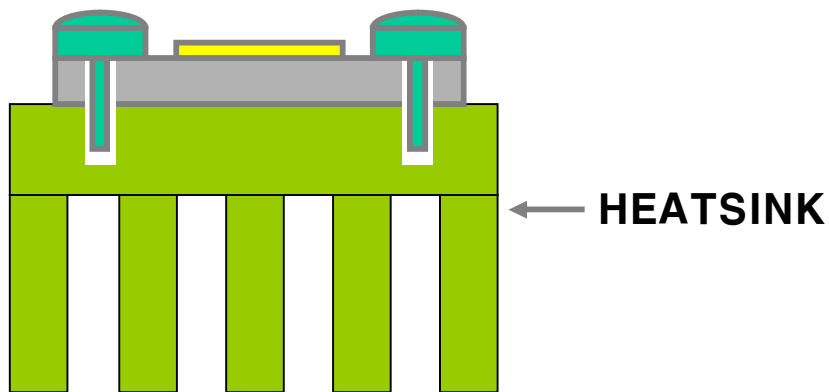

• Notes

- Please use M1.6 screw necessarily.
- Do not release screw while LED is operating.
- Use two screws.
- Fix LED package on heat sink tightly.

Rev. 01

September 2012

WWW.SEOULSEMICON.COM

서식번호 : SSC-QP-7-07-18 (Rev.00)

Rtotal vs Power Consumption(SAWW8F1A)

	User side		LED Emitter
Input Voltage (V)	Total Power Consumption (W) -Power Factor is reflected	Rtotal (Ω)	Actual LED Power Consumption (W)
110	9.9	98	8.9
110	10.9	82	9.9
110	11.9	66	10.9
110	12.9	55	11.9
110	13.9	41	13.1

	User side		LED Emitter
Input Voltage (V)	Total Power Consumption (W) -Power Factor is reflected	Rtotal (Ω)	Actual LED Power Consumption (W)
120	10.8	183	9.0
120	11.9	158	10.0
120	12.9	135	11.0
120	14.0	120	12.0
120	15.1	104	13.1

	User side		LED Emitter
Input Voltage (V)	Total Power Consumption (W) -Power Factor is reflected	Rtotal (Ω)	Actual LED Power Consumption (W)
130	11.7	273	9.0
130	12.9	241	10.0
130	14.0	213	11.0
130	15.2	189	12.0
130	16.4	166	13.1

*** Note**

User's Power Consumption means total power including resistor.

The Rtotal could be different by user's operating conditions such as temperature, device tolerance, etc.

Rev. 01

September 2012

Rtotal vs Power Consumption(SAWW8D1A)

	User side		LED Emitter
Input Voltage (V)	Total Power Consumption (W) -Power Factor is reflected	Rtotal (Ω)	Actual LED Power Consumption (W)
220	9.9	448	8.8
220	11.9	310	10.8
220	13.9	221	12.8
220	15.8	164	14.8

	User side		LED Emitter
Input Voltage (V)	Total Power Consumption (W) -Power Factor is reflected	Rtotal (Ω)	Actual LED Power Consumption (W)
230	10.4	635	8.8
230	12.4	468	10.7
230	14.5	346	12.8
230	16.6	260	14.9

*** Note**

User's Power Consumption means total power including resistor.

The Rtotal could be different by user's operating conditions such as temperature, Rev. 01 device tolerance, etc.

September 2012

WWW.SEOULSEMICON.COM

서식번호 : SSC-QP-7-07-18 (Rev.00)

	User side		LED Emitter
Input Voltage (V)	Total Power Consumption (W) -Power Factor is reflected	Rtotal (Ω)	Actual LED Power Consumption (W)
240	10.8	802	8.8
240	13.0	608	10.8
240	15.1	474	12.8
240	17.3	384	14.8

	User side		LED Emitter
Input Voltage (V)	Total Power Consumption (W) -Power Factor is reflected	Rtotal (Ω)	Actual LED Power Consumption (W)
250	11.3	988	8.8
250	13.5	760	10.8
250	15.8	600	12.8
250	18.0	474	15.0

*** Note**

User's Power Consumption means total power including resistor.

The Rtotal could be different by user's operating conditions such as temperature, Rev. 01 device tolerance, etc.

September 2012

Labeling

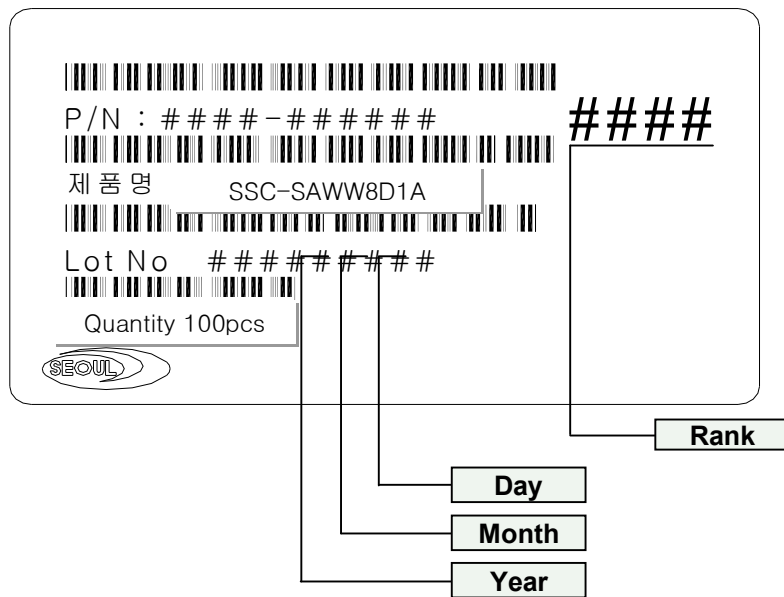
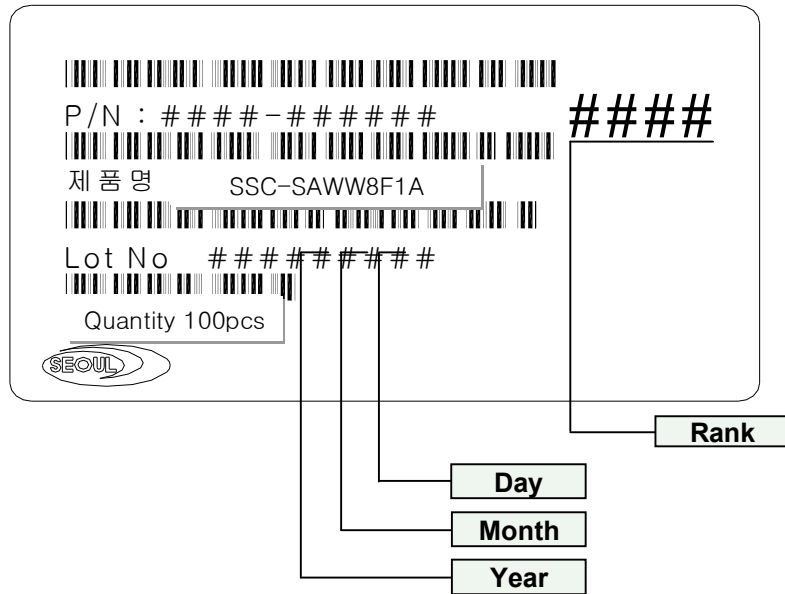

Rank

#1#2#3#4

- #1 : Luminous Flux : LF [lm]
- #2#3 : Color Coordinates : x, y
- #4 : Forward Voltage : V_F [V]

Packaging (Tray)

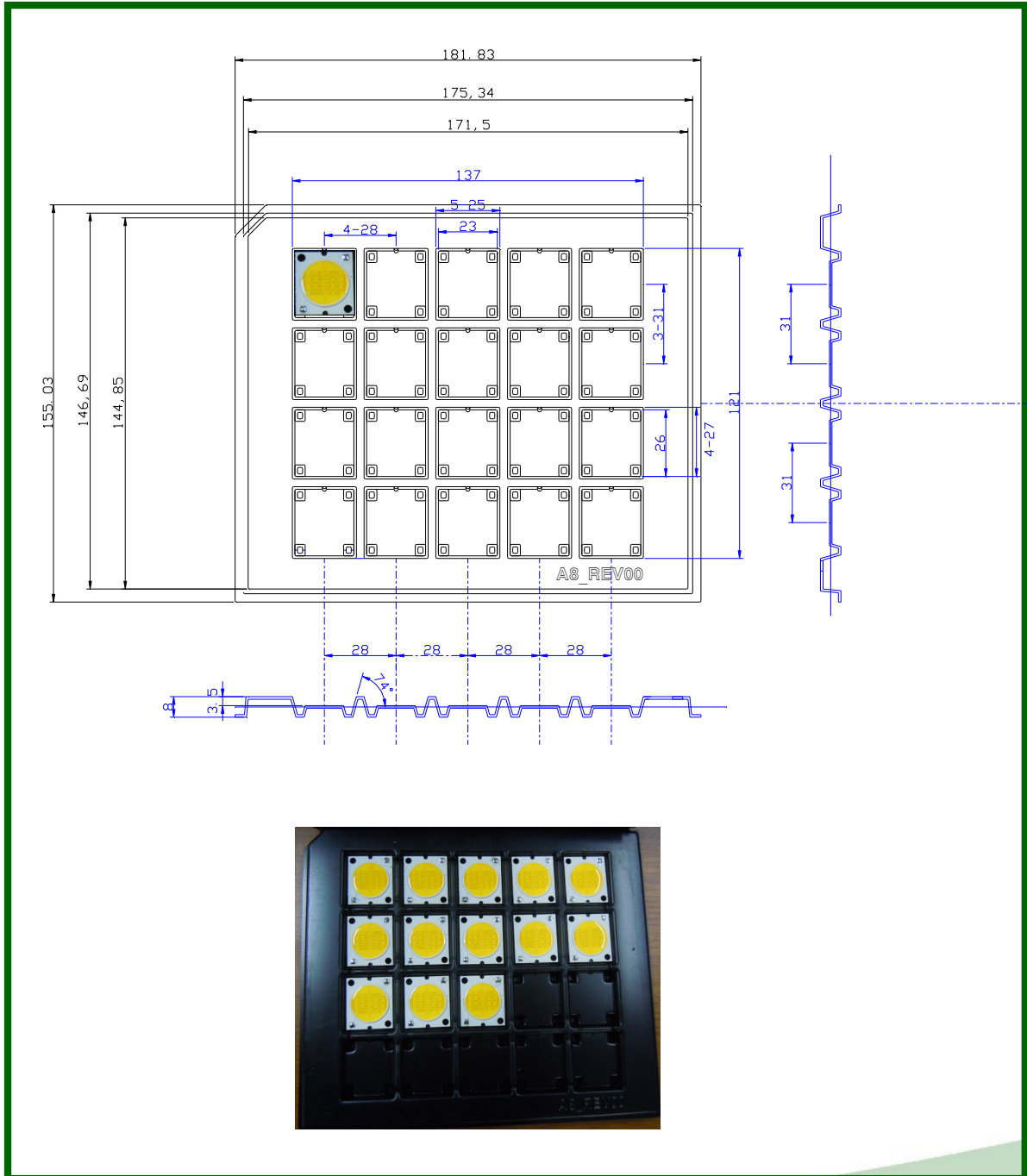

Packaging (Bag and Box)

<Moisture-proof bag*1>

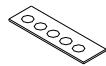
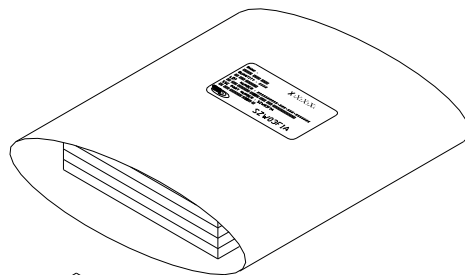

- Desiccant

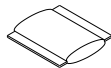

- Humidity Indicator

<Outer Box Structure>

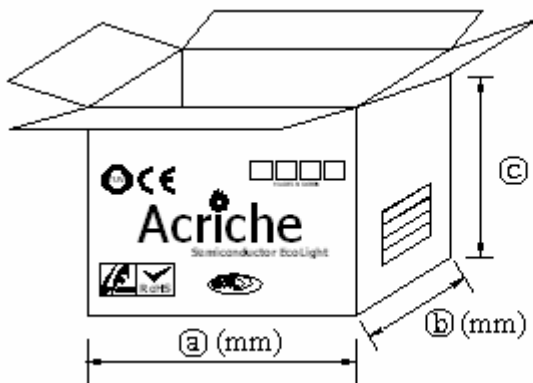

TYPE	SIZE (mm)		
	⌀	⌀	⌀
7inch	245	220	142
	245	220	80

* Notice

1. Heat Sealed after packing (Use Zipper Bag)

Precaution for use

- Storage

To avoid the moisture penetration, we recommend storing Acrich Power LEDs in a dry box with a desiccant . The recommended storage temperature range is 5C to 30C and a maximum humidity of 70%.

- Use Precaution after Opening the Packaging

Pay attention to the following:

- a. Soldering should be done immediately after opening the package (within 24Hrs).
 - b. Required conditions after opening the package
 - Sealing
 - Temperature : 5 ~ 40℃ Humidity : less than 50%
 - c. If the package has been opened more than 1 week or the color of the desiccant changes, components should be dried for 10-12hr at 60±5℃
- Do not apply mechanical force or excess vibration during the cooling process to normal temperature after soldering.
 - Do not rapidly cool device after soldering.
 - Components should not be mounted on warped (non coplanar) portion of PCB.
 - Radioactive exposure is not considered for the products listed here in.
 - This device should not be used in any type of fluid such as water, oil, organic solvent and etc. When washing is required, IPA (Isopropyl Alcohol) should be used.
 - When the LEDs are in operation the maximum current should be decided after measuring the package temperature.
 - LEDs must be stored properly to maintain the device. If the LEDs are stored for 3 months or more after being shipped from SSC, a sealed container with vaccum atmosphere should be used for storage.
 - The appearance and specifications of the product may be modified for improvement without notice.
 - Long time exposure of sunlight or occasional UV exposure will cause silicone discoloration.
 - Attaching LEDs, do not use adhesives that outgas organic vapor.

Handling of Silicone resin LEDs

Notes for handling:

- Avoid touching silicone resin parts especially with sharp tools such as Pincette (Tweezers)
- Avoid leaving fingerprints on silicone resin parts.
- Silicone resin will attract dust so use covered containers for storage.
- It is not recommend to cover the silicone resin of the LEDs with other resin (epoxy, urethane, etc)