

PRODUCT SPECIFICATION

DATE : 02/22/2011

cosmo ELECTRONICS CORPORATION	SOLID STATE RELAY - MOSFET OUTPUT KAQW614HA	NO.61M22004	REV. 2
		SHEET 1 OF 10	

● OUTSIDE DIMENSION :

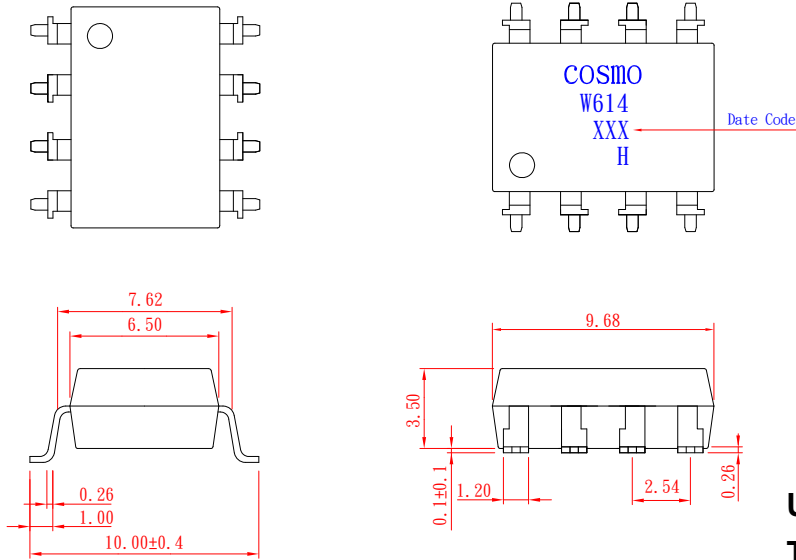

● Operate / Reverse time (N.C)

● Turn on / Turn off time (N.O)

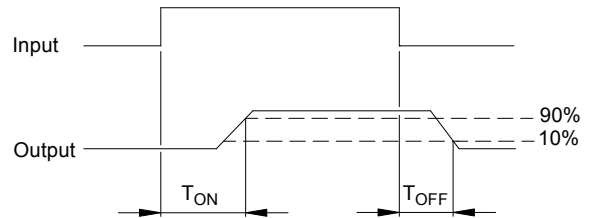
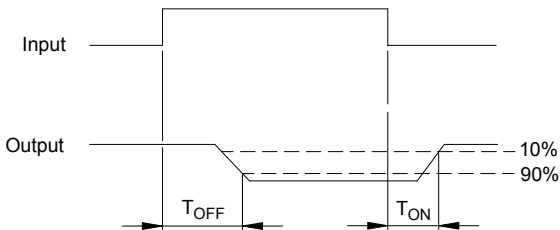

● Schematic and Wiring Diagrams

Schematic	Output Configuration	Load	Connection	Wiring Diagrams
	<p>1a1b</p> <p>1 FORM A/B 1 FORM C</p>	AC/DC	-	<p>(1) Two independent 1 Form A & 1 Form B use</p> <p>(2) 1 Form A 1 Form B use</p>

PRODUCT SPECIFICATION

DATE : 02/22/2011

cosmo ELECTRONICS CORPORATION	SOLID STATE RELAY - MOSFET OUTPUT KAQW614HA	NO.61M22004	REV. 2
		SHEET 2 OF 10	

● Absolute Maximum Ratings

(Ta=25°C)

Emitter (Input)		Detector (Output)	
Reverse Voltage	5.0V	Output Breakdown Voltage	± 400V
Continuous Forward Current	50mA	Continuous Load Current	± 130mA
Peak Forward Current	1A	Power Dissipation	500mW
Power Dissipation	100mW		
Derate Linearly from 25°C	1.3mW/°C		

General Characteristics

Isolation Test Voltage	5000VACrms	Storage Temperature Range	-40°C to +125°C
Isolation Resistance		Operating Temperature Range ...	-40°C to +85°C
Viso=500V, Ta=25°C	≥ 10 ¹⁰ Ω	Junction Temperature	100°C
Total Power Dissipation	550mW	Soldering Temperature ,	
Derate Linearly from 25°C	2.5mW/°C	2mm from case , 10 sec	260°C

● Electro-optical Characteristics

(Ta=25°C)

Parameter	Symbol	Conditions	Min.	Typ.	Max.	Unit
Emitter (Input)						
Forward Voltage	V _F	I _F =10mA		1.2	1.5	V
Operation Input Current	I _{FON} (N.O) I _{FOFF} (N.C)	V _L =±20V, I _L =100mA (N.O) V _L =±20V, I _L ≤5μA (N.C) t=10ms			5	mA
Recovery Input Current	I _{FOFF} (N.O) I _{FON} (N.C)	V _L =±20V, I _L ≤5μA (N.O) V _L =±20V, I _L =100mA (N.C) t=10ms	0.2			mA

Detector (Output) normally open

Output Breakdown Voltage	V _B	I _B =50μA	400			V
Output Off-State Leakage	I _{TOFF}	V _T =100V, I _F =0mA		0.2	1	μA
I/O Capacitance	C _{ISO}	I _F =0, f=1MHz		6		pF
ON Resistance	R _{ON}	I _L =100mA, I _F =10mA		20	30	Ω
Turn-On Time	T _{ON}	I _F =10mA, V _L =±20V		0.3	1.0	ms
Turn-Off Time	T _{OFF}	t=10mS, I _L =±100mA		0.7	1.5	ms

Detector (Output) normally close

Output Breakdown Voltage	V _B	I _B =50μA, I _F =10mA	400			V
Output Off-State Leakage	I _{TOFF}	V _T =100V, I _F =10mA		0.2	2	μA
I/O Capacitance	C _{ISO}	I _F =0, f=1MHz		6		pF
ON Resistance	R _{ON}	I _L =100mA, I _F =0mA		25	50	Ω
Operate (OFF) Time	T _{OFF}	I _F =10mA, V _L =±20V		0.6	1.5	ms
Reverse (ON) Time	T _{ON}	t=10ms, I _L =±100mA		0.3	1.0	ms

PRODUCT SPECIFICATION

DATE : 02/22/2011

cosmo
ELECTRONICS CORPORATION

SOLID STATE RELAY - MOSFET OUTPUT
KAQW614HA

NO.61M22004
SHEET 3 OF 10

REV.
2

● Data Curve (Normally Open Characteristics)

Load current vs. ambient temperature
Allowable ambient Temperature :
-40°C to +85°C

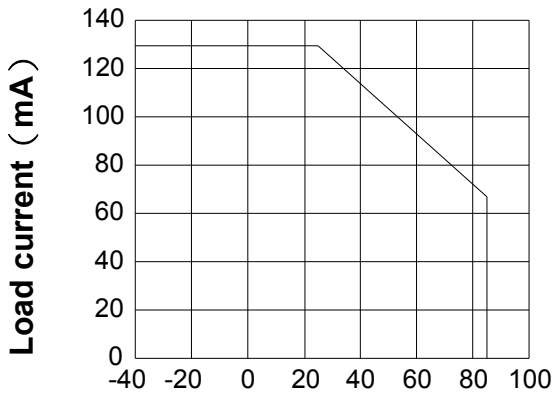

Ambient temperature Ta (°C)

On resistance vs. ambient temperature
across terminals 5 and 6 pin
LED current : 5mA
Continuous load current : 130mA (DC)

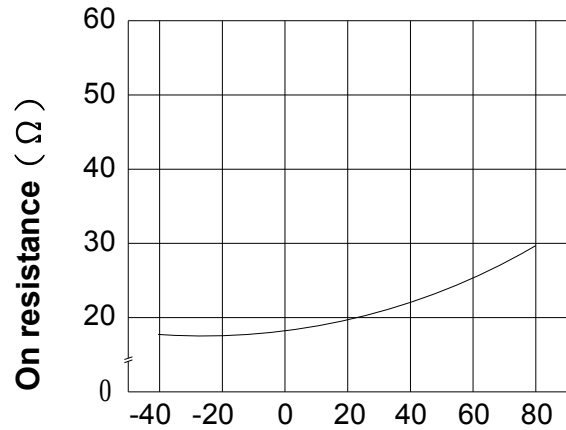

Ambient temperature Ta (°C)

Turn on time vs. ambient temperature
Load voltage 400V (DC)
LED current : 5mA
Continuous load current : 130mA (DC)

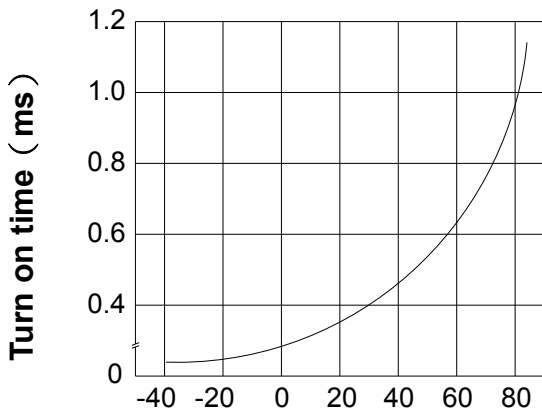

Ambient temperature Ta (°C)

Turn off time vs. ambient temperature
Load voltage 400V (DC)
LED current : 5mA
Continuous load current : 130mA (DC)

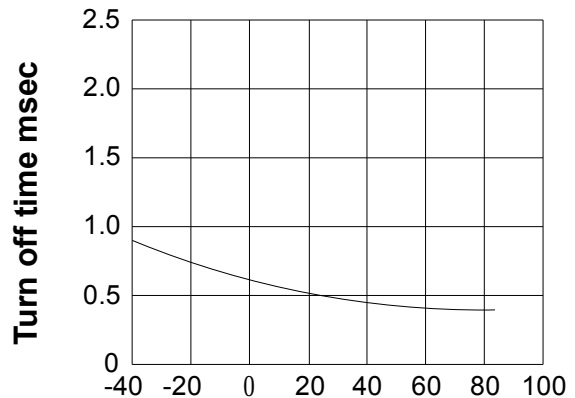

Ambient temperature Ta (°C)

PRODUCT SPECIFICATION

DATE : 02/22/2011

cosmo
ELECTRONICS CORPORATION

SOLID STATE RELAY - MOSFET OUTPUT
KAQW614HA

NO.61M22004
SHEET 4 OF 10

REV.
2

LED operate current vs.
ambient temperature

Load Voltage : 400V (DC)

Continuous load current : 130mA (DC)

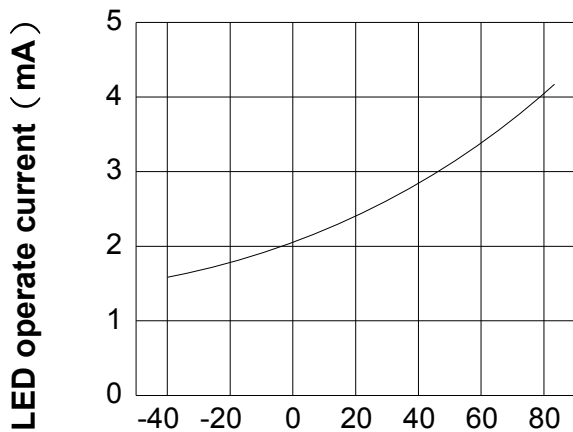

Ambient temperature Ta (°C)

LED Turn Off current vs.
ambient temperature

Load Voltage : 400V (DC)

Continuous load current : 130mA (DC)

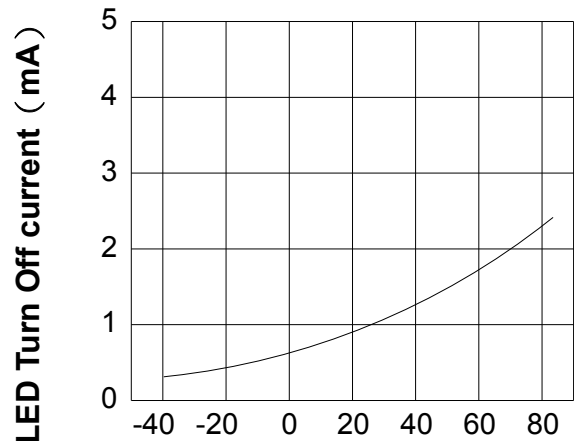

Ambient temperature Ta (°C)

LED dropout voltage vs.
ambient temperature

LED current : 5 to 50mA

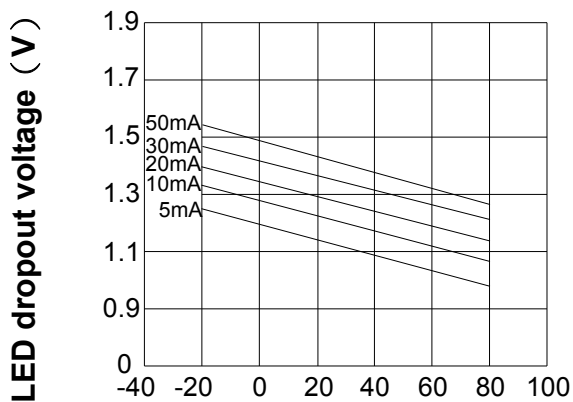

Ambient temperature Ta (°C)

Voltage vs. current characteristics
of output at MOSFET portion

Measured portion : across terminals
5 and 6 pin

Ambient temperature : 25°C

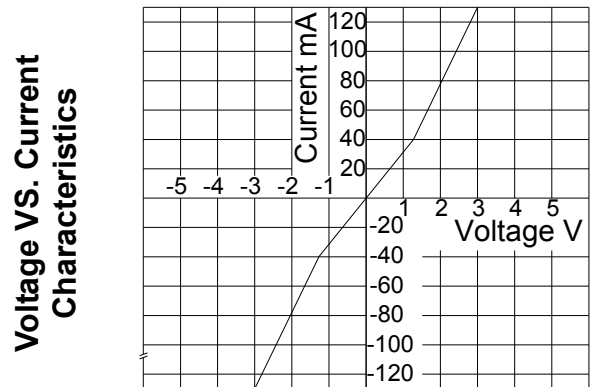

Ambient temperature : 25°C

PRODUCT SPECIFICATION

DATE : 02/22/2011

cosmo
ELECTRONICS CORPORATION

SOLID STATE RELAY - MOSFET OUTPUT
KAQW614HA

NO.61M22004
SHEET 5 OF 10

REV.
2

LED forward current vs. turn on time

Across terminals 5 and 6 pin

Load voltage : 400V (DC)

Continuous load current : 130mA (DC)

Ambient temperature : 25°C

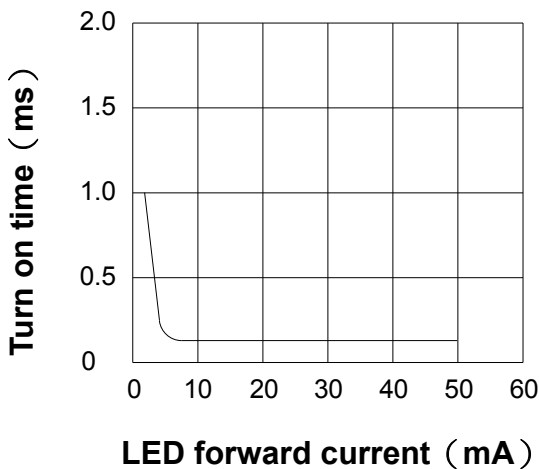

Off state leakage current

Across terminals 5 and 6 pin

Ambient temperature : 25°C

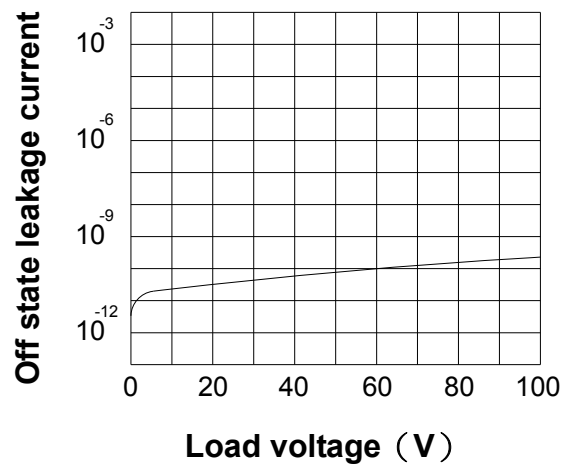

LED forward current vs. turn off time

Across terminals 5 and 6 pin

Load voltage : 400V (DC)

Continuous load current : 130mA (DC)

Ambient temperature : 25°C

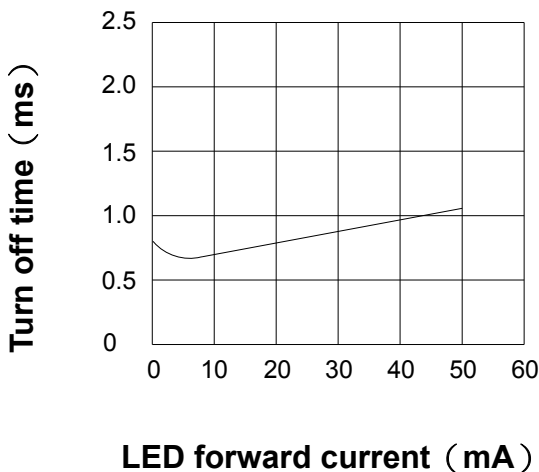

Applied voltage vs. output capacitance

Across terminals 5 and 6 pin

Frequency : 1MHz

Ambient temperature : 25°C

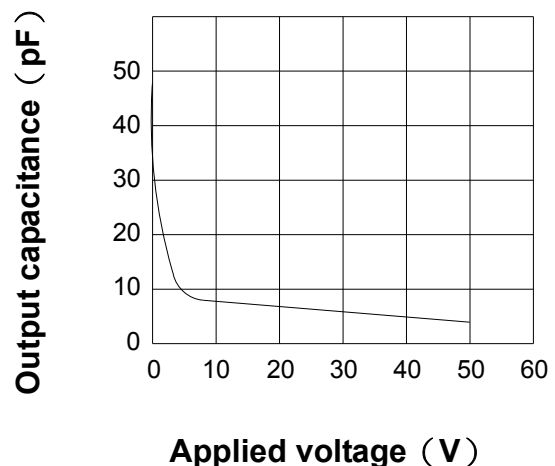

PRODUCT SPECIFICATION

DATE : 02/22/2011

cosmo
ELECTRONICS CORPORATION

SOLID STATE RELAY - MOSFET OUTPUT
KAQW614HA

NO.61M22004
SHEET 6 OF 10

REV.
2

● Data Curve (Normally Close Characteristics)

Load current vs. ambient temperature
Allowable ambient Temperature :
-40°C to +85°C

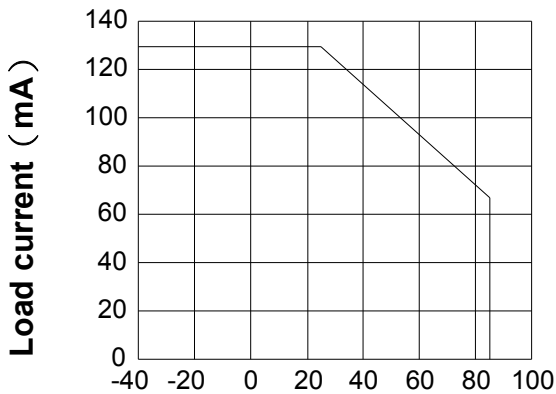

Ambient temperature Ta (°C)

On resistance vs. ambient temperature
across terminals 7 and 8 pin
LED current : 0mA
Continuous load current : 130mA (DC)

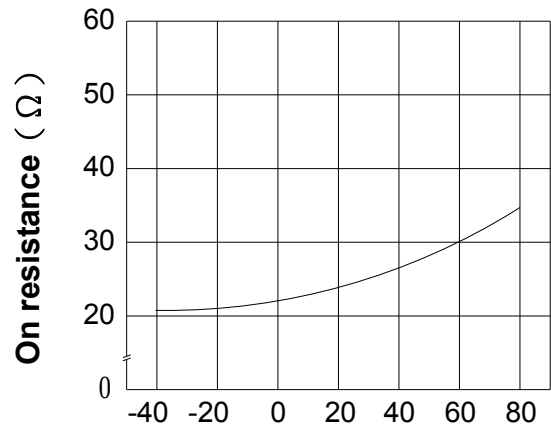

Ambient temperature Ta (°C)

Operate (OFF) time vs.
ambient temperature
Load voltage 400V (DC)
LED current : 5mA
Continuous load current : 130mA (DC)

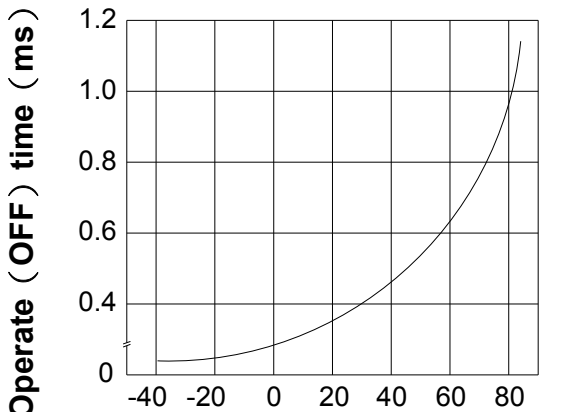

Ambient temperature Ta (°C)

Reverse (ON) time vs.
ambient temperature
Load voltage 400V (DC)
LED current : 5mA
Continuous load current : 130mA (DC)

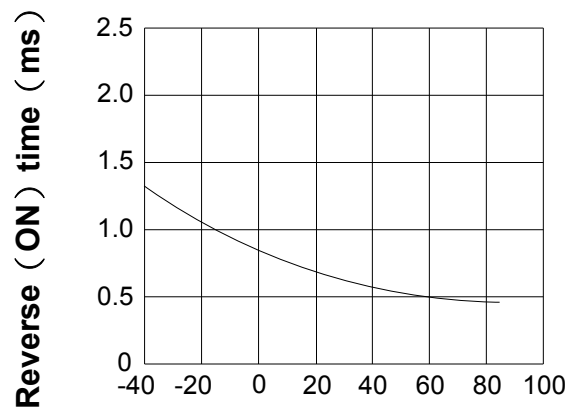

Ambient temperature Ta (°C)

PRODUCT SPECIFICATION

DATE : 02/22/2011

cosmo
ELECTRONICS CORPORATION

SOLID STATE RELAY - MOSFET OUTPUT
KAQW614HA

NO.61M22004
SHEET 7 OF 10

REV.
2

LED Operate (OFF) current vs.
ambient temperature

Load Voltage : 400V (DC)

Continuous load current : 130mA (DC)

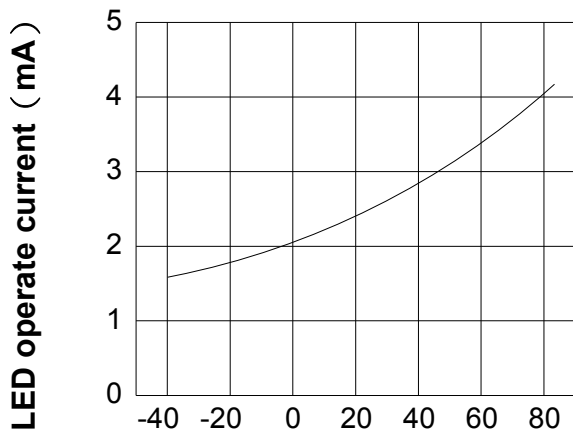

Ambient temperature Ta (°C)

LED Reverse (ON) current vs.
ambient temperature

Load Voltage : 400V (DC)

Continuous load current : 130mA (DC)

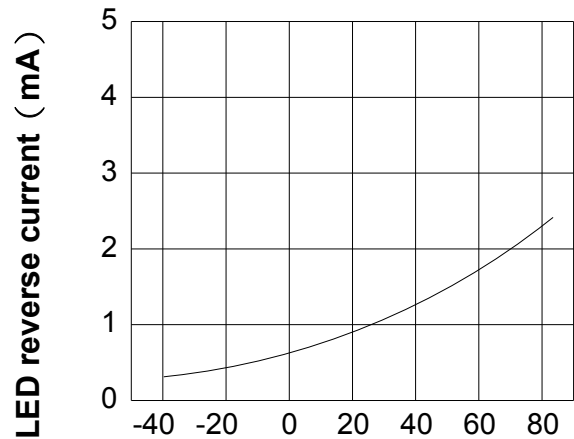

Ambient temperature Ta (°C)

LED dropout voltage vs.
ambient temperature

LED current : 5 to 50mA

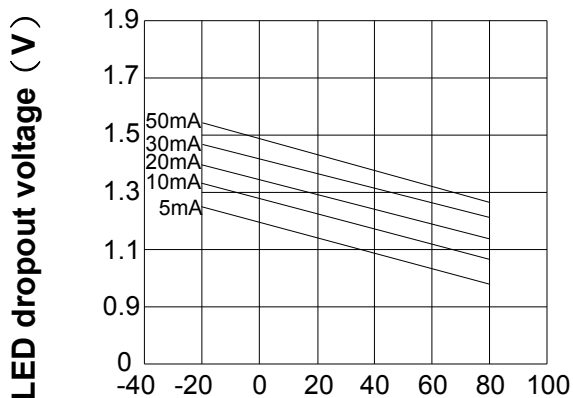

Ambient temperature Ta (°C)

Voltage vs. current characteristics
of output at MOSFET portion

Measured portion : across terminals
7 and 8 pin

Ambient temperature : 25°C

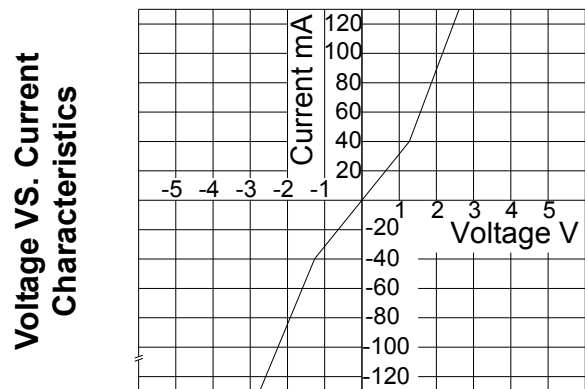

Ambient temperature : 25°C

PRODUCT SPECIFICATION

DATE : 02/22/2011

cosmo ELECTRONICS CORPORATION	SOLID STATE RELAY - MOSFET OUTPUT KAQW614HA	NO.61M22004	REV. 2
		SHEET 8 OF 10	

LED forward current vs. operate (OFF) time

Across terminals 7 and 8 pin

Load voltage : 400V (DC)

Continuous load current : 130mA (DC)

Ambient temperature : 25°C

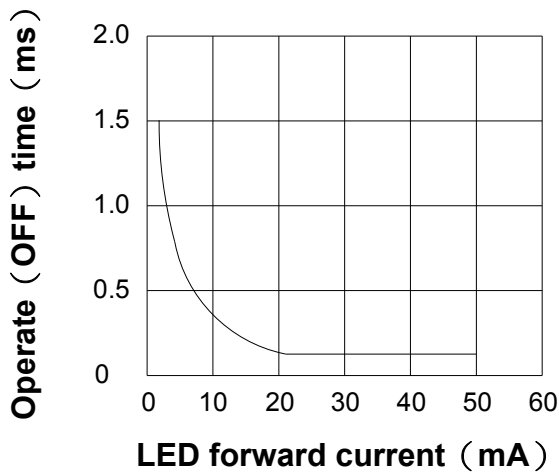

Off state leakage current

Across terminals 7 and 8 pin

Ambient temperature : 25°C

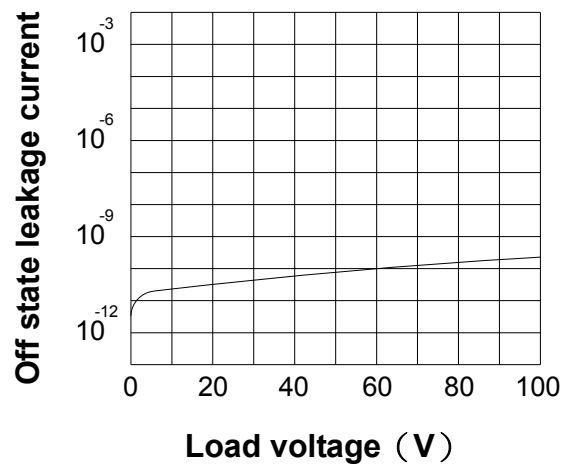

LED forward current vs. reverse (ON) time

Across terminals 7 and 8 pin

Load voltage : 400V (DC)

Continuous load current : 130mA (DC)

Ambient temperature : 25°C

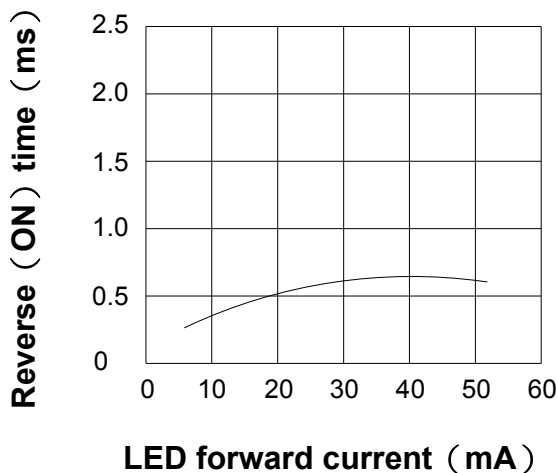

Applied voltage vs. output capacitance

Across terminals 7 and 8 pin

Frequency : 1MHz

Ambient temperature : 25°C

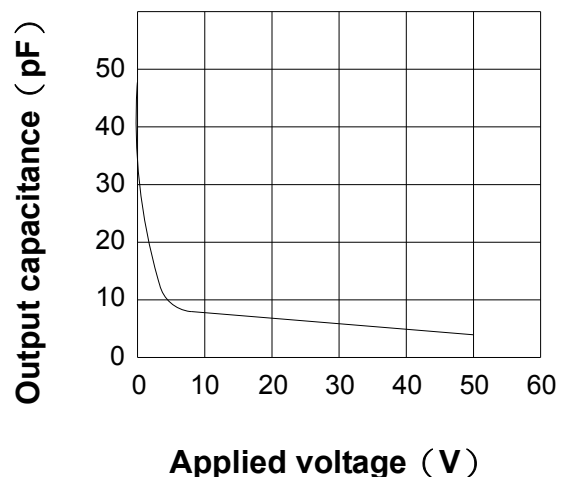

PRODUCT SPECIFICATION

DATE : 02/22/2011

cosmo
ELECTRONICS CORPORATION

SOLID STATE RELAY - MOSFET OUTPUT
KAQW614HA

NO.61M22004
SHEET 9 OF 10

REV.
2

● USING METHODS

Examples of resistance value to control LED forward current (I_F)

SSR-MOSFET OUTPUT

($I_F=5\text{mA}$)

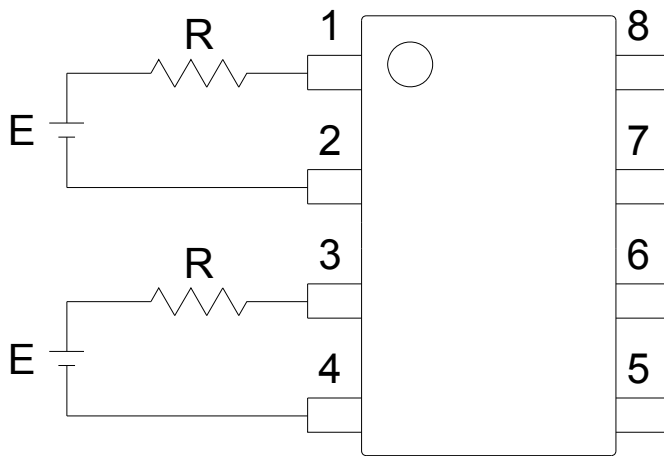

E	R
3.3V	Approx. 330 Ω
5V	Approx. 640 Ω
12V	Approx. 1.9K Ω
15V	Approx. 2.5K Ω
24V	Approx. 4.1K Ω

- (1) LED forward current must be more than 5mA , at E min.
- (2) LED forward current must be less than 50mA , at E max.

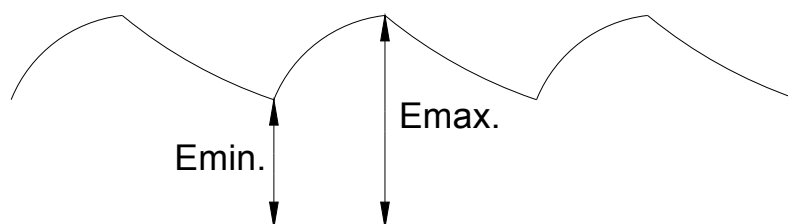

PRODUCT SPECIFICATION

DATE : 02/22/2011

cosmo
ELECTRONICS CORPORATION

SOLID STATE RELAY - MOSFET OUTPUT
KAQW614HA

NO.61M22004
SHEET 10 OF 10

REV.
2

● USING METHODS

Regulate the spike voltage generated on the inductive load as follows :

