

SERVICE MANUAL

BG-3S CHASSIS

MODEL COMMANDER DEST. CHASSIS NO. | MODEL COMMANDER DEST. CHASSIS NO.

KV-EF34M80 *RM-951* *Vietnam* *SCC-U28D-A*

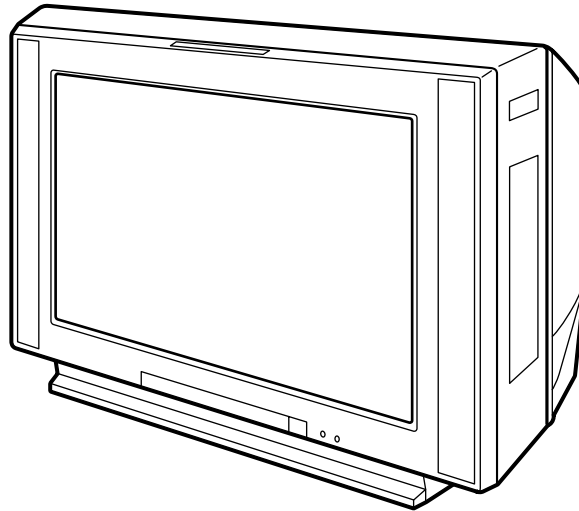
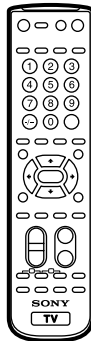

TRINITRON[®] COLOR TV
SONY[®]

SPECIFICATIONS

		Note
Power requirements	110-240 V AC, 50/60 Hz	
Power consumption (W)	Indicated on the rear of the TV	
Television system	B/G, I, D/K, M	
Color system	PAL, PAL 60, SECAM, NTSC4.43, NTSC3.58	
Channel coverage		
B/G	VHF: E2 to E12 / UHF: E21 to E69 / CATV: S01 to S03, S1 to S41	
I	UHF: B21 to B68 / CATV: S01 to S03, S1 to S41	
D/K	VHF: C1 to C12, R1 to R12 / UHF: C13 to C57, R21 to R60 CATV: S01 to S03, S1 to S41, Z1 to Z39	
M	VHF: A2 to A13 / UHF: A14 to A79 CATV: A-8 to A-2, A to W+4, W+6 to W+84	
⏏ (Antenna)	75-ohm external terminal	
Audio output	15W + 15W	10% distortion
Number of terminal		
📺 (Video)	Input: 4 Output: 1	Phono jacks; 1 V _{p-p} , 75 ohms
🎵 (Audio)	Input: 4 Output: 1	Phono jacks; 500 mV _{rms}
📺 (S Video)	Input: 2	Y : 1 V _{p-p} , 75 ohms, unbalanced, sync negative C : 0.286 V _{p-p} , 75 ohms
📺 (Component Video)	Input: 1	Phono jacks; Y : 1.0 V _{p-p} , 75 ohms, sync negative C _B : 0.7 V _{p-p} , 75 ohms C _R : 0.7 V _{p-p} , 75 ohms Audio : 500 mV _{rms}
🎧 (Headphone)	Output: 1	Stereo minijack
Picture tube	34 inch	
Tube size (cm)	86 (Measured diagonally)	
Screen size (cm)	80 (Measured diagonally)	
Screen size (mm)	800 (Measured diagonally)	
Dimension (w/h/d, mm)	859 × 661 × 574	
Mass (kg)	83	

Design and specifications are subject to change without notice.

CAUTION

SHORT CIRCUIT THE ANODE OF THE PICTURE TUBE AND THE ANODE CAP TO THE METAL CHASSIS, CRT SHIELD, OR CARBON PAINTED ON THE CRT, AFTER REMOVING THE ANODE.

SAFETY-RELATED COMPONENT WARNING!!

COMPONENTS IDENTIFIED BY SHADING AND MARK \triangle ON THE SCHEMATIC DIAGRAMS, EXPLODED VIEWS AND IN THE PARTS LIST ARE CRITICAL TO SAFE OPERATION. REPLACE THESE COMPONENTS WITH SONY PARTS WHOSE PART NUMBERS APPEAR AS SHOWN IN THIS MANUAL OR IN SUPPLEMENTS PUBLISHED BY SONY.

TABLE OF CONTENTS

<u>Section</u>	<u>Title</u>	<u>Page</u>	<u>Section</u>	<u>Title</u>	<u>Page</u>
	SELF DIAGNOSIS FUNCTION	4	5. DIAGRAMS		
1. GENERAL		8	5-1. Block Diagram		51
2. DISASSEMBLY			5-2. Frame Schematic Diagram		59
2-1. Rear Cover Removal		28	5-3. Circuit Boards Location		69
2-2. Speaker Box Removal		28	5-4. Schematic Diagrams and Printed Wiring Boards		52
2-3. Chassis Assy Removal		28	(1) Schematic Diagram of A(1/2) Board		67
2-4. Service Position		28	(2) Schematic Diagram of A(2/2) Board		71
2-5. D2 and DH Boards Removal		29	(3) Schematic Diagram of B(1/2) Board		75
2-6. J1 Board RF Splitter Removal		29	(4) Schematic Diagrams of B(2/2) and F Boards		78
2-7. B1, V1 and P Boards Removal		29	(5) Schematic Diagrams of P(1/3) Board		89
2-8. A and B Boards Removal		30	(6) Schematic Diagram of P(2/3) Board		92
2-9. H1 Board Removal		30	(7) Schematic Diagrams of P(3/3), J1 and B4 Boards ..		95
2-10. Demagnetization Coil Removal		30	(8) Schematic Diagrams of C and H1 Boards		99
2-11. Top Switch Removal		30	(9) Schematic Diagrams of VM2 and DH Boards		106
2-12. Picture Tube Removal		31	(10) Schematic Diagram of D2 board		111
3. SET-UP ADJUSTMENTS			5-5. Semiconductors		113
3-1. Beam Landing		32	6. EXPLODED VIEWS		
3-2. Convergence		33	6-1. Picture Tube		116
3-3. Focus Adjustment		35	6-2. Chassis		117
3-4. Neck Assy Twist Adjustment		35	7. ELECTRICAL PARTS LIST		118
3-5. G2 (Screen) and White Balance Adjustments		36			
3-6. Frequency (Free Run) Adjustment		36			
4. CIRCUIT ADJUSTMENTS					
4-1. Adjustments with Commander		37			
4-2. Adjustment Method		38			
4-3. Picture Quality Adjustments		45			
4-4. A Board Adjustment After IC003 (Memory) Replacement		46			
4-5. Picture Distortion Adjustment		47			

SELF DIAGNOSTIC FUNCTION

The units in this manual contain a self-diagnostic function. If an error occurs, the STANDBY/TIMER lamp will automatically begin to flash.

The number of times the lamp flashes translates to a probable source of the problem. A definition of the STANDBY/TIMER lamp flash indicators is listed in the instruction manual for the user's knowledge and reference. If an error symptom cannot be reproduced, the remote commander can be used to review the failure occurrence data stored in memory to reveal past problems and how often these problems occur.

1. DIAGNOSTIC TEST INDICATORS

When an errors occurs, the STANDBY/TIMER lamp will flash a set number of times to indicate the possible cause of the problem. If there is more than one error, the lamp will identify the first of the problem areas.

Result for all of the following diagnostic items are displayed on screen. No error has occurred if the screen displays a "0".

Diagnostic Item Description	No. of times STANDBY/TIMER lamp flashes	Self-diagnostic display/Diagnostic result	Probable Cause Location	Detected Symptoms
• Power does not turn on	Does not light	—	<ul style="list-style-type: none"> • Power cord is not plugged in. • Fuse is burned out F3601 (H3) 	<ul style="list-style-type: none"> • Power does not come on. • No power is supplied to the TV. • AC power supply is faulty.
<ul style="list-style-type: none"> • +B overcurrent (OCP) or overvoltage (OVP) • Vertical deflection stopped • Horizontal deflection overdrive 	2 times	002:000 or 002:001~255 003:001~255 004:001~255 at the same time	<ul style="list-style-type: none"> • H.OUT Q511 is shorted. (A board) • IC701 is shorted. (C board) • -13V is not supplied. (A board) • IC 503 faulty (A board) 	<ul style="list-style-type: none"> • Power does not come on. • Load on power line is shorted. • Has entered standby state after horizontal raster. • Vertical deflection pulse is stopped. • Power line is shorted or power supply is stopped.
• White balance failure (no PICTURE)	5 times	005:000 or 005:001~225	<ul style="list-style-type: none"> • G2 is improperly adjusted. (Note 2) • CRT problem. • Video OUT IC701 is faulty. (C board) • IC301 is faulty. (A board) • No connection A board to C board. 	<ul style="list-style-type: none"> • No raster is generated. • CRT cathode current detection reference pulse output is small.
• Micro reset	—	101:00 or 101:001~225	<ul style="list-style-type: none"> • Discharge CRT (C Board) • Static discharge • External noise 	<ul style="list-style-type: none"> • Power is shut down shortly, after this return back to normal. • Detect Micro latch up.

Note 1: If a + B overcurrent is detected, stoppage of the vertical deflection is detected simultaneously.

The symptom that is diagnosed first by the microcontroller is displayed on the screen.

Note 2: Refer to screen (G2) Adjustment in section 3-4 of this manual.

2. DISPLAY OF STANDBY/TIMER LIGHT FLASH COUNT

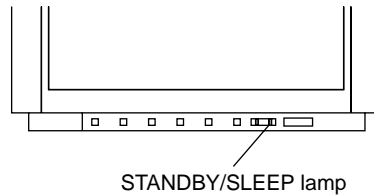
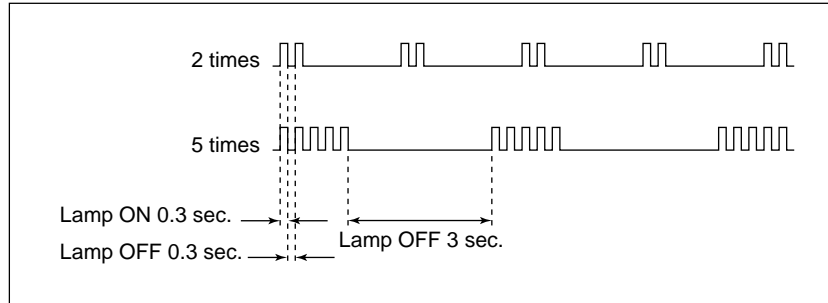

<u>Diagnostic Item</u>	<u>Flash Count*</u>
+B overcurrent/overvoltage Vertical deflection stopped	2 times
White balance failure	5 times

* One flash count is not used for self-diagnostic.

3. STOPPING THE STANDBY/TIMER FLASH

Turn off the power switch on the TV main unit or unplug the power cord from the outlet to stop the STANDBY/TIMER lamp from flashing.

4. SELF-DIAGNOSTIC SCREEN DISPLAY

For errors with symptoms such as “power sometimes shuts off” or “screen sometimes goes out” that cannot be confirmed, it is possible to bring up past occurrences of failure for confirmation on the screen:

[To Bring Up Screen Test]

In standby mode, press buttons on the remote commander sequentially in rapid succession as shown below:

Screen display → channel [5] → Sound volume [−] → Power ON
 ↑

Note that this differs from entering the service mode (mode volume [+]).

Self-Diagnosis screen display

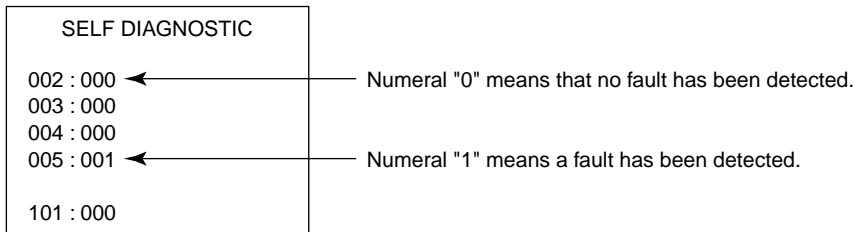

5. HANDLING OF SELF-DIAGNOSTIC SCREEN DISPLAY

Since the diagnostic results displayed on the screen are not automatically cleared, always check the self-diagnostic screen during repairs. When you have completed the repairs, clear the result display to “0”.

Unless the result display is cleared to “0”, the self-diagnostic function will not be able to detect subsequent faults after completion of the repairs.

[Clearing the result display]

To clear the result display to “0”, press buttons on the remote commander sequentially as shown below when the diagnostic screen is being displayed.

Channel [8] → 0

[Quitting Self-diagnostic screen]

To quit the entire self-diagnostic screen, turn off the power switch on the remote commander or the main unit.

6. SELF-DIAGNOSTIC CIRCUIT

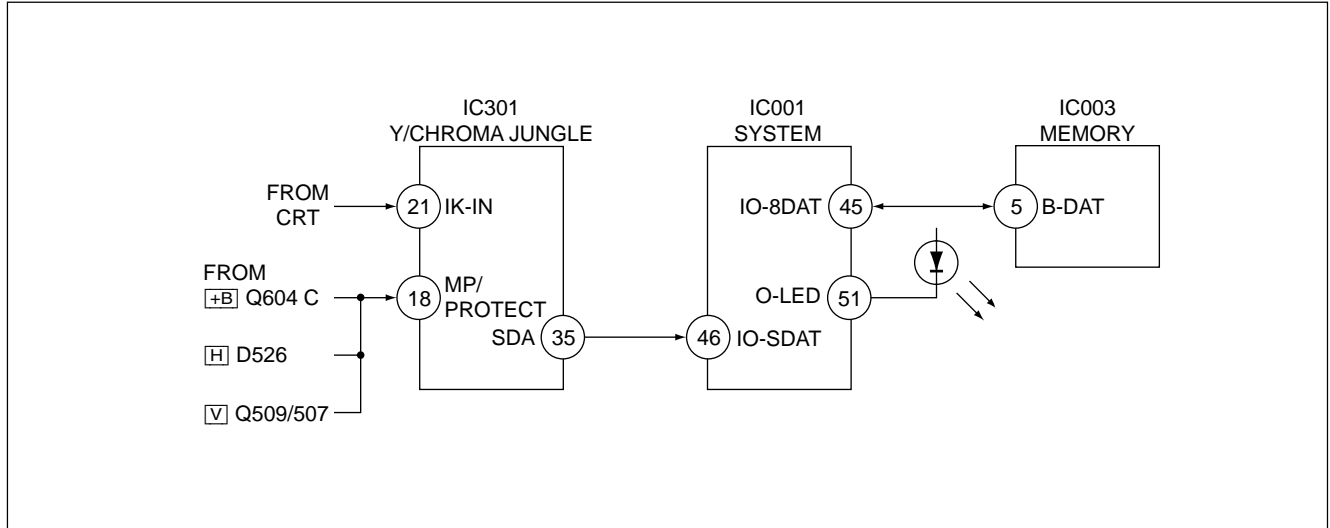

+B overcurrent (OCP)

Occurs when an overcurrent on the +B(135) line is detected by Q604 (A board). If Q604 (A board) go to ON and the voltage to pin 18 of IC301 (A board) should go down when V.SYNC is more than seven verticals in a period, the unit will automatically turn off.

Horizontal deflection overdrive

Occurs when an overdrive on H drive line is detected by D526 (A board). Power supply will be shut down when detect it.

Vertical deflection stopped

Occurs when an absence of the vertical deflection pulse is detected by Q509 (A board) and IC001 (A board) shut down the power supply.

Vertical deflection overcurrent

Occurs when an overcurrent on V drive line is detected by Q507 (A board). Power supply will be shut down when detect this by IC001 (A board).

White balance failure

If the RGB levels* do not balance or become low level within 5 seconds, this error will be detected by IC301 (A board). TV will stay on, but there will be no picture.







* (Refers to the RGB levels of the AKB detection Ref pulse that detects IK.)

The operating instructions mentioned here are partial abstracts from the Operating Instruction Manual. The page numbers of the Operating Instruction Manual remain as in the manual.

SECTION 1 GENERAL

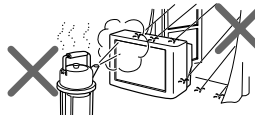
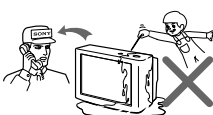
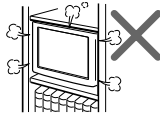
WARNING

- Dangerously high voltages are present inside the TV.
- Operate the TV only between 110 – 240 V AC.

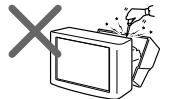
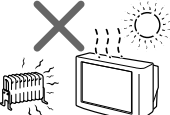
 <p>For your own safety, do not touch any part of the TV, the power cord and the antenna cable during lightning storms.</p>	 <p>Install the TV in a stable position. Do not allow children to climb onto it.</p>
 <p>To prevent fire or shock hazard, do not expose the TV to rain or moisture.</p>	 <p>Do not operate the TV if any liquid or solid object falls into it. Have it checked immediately by qualified personnel only.</p>
 <p>Do not install the TV in a confined space, such as a bookcase or built-in cabinet. Do not block the ventilation openings of the TV.</p>	 <p>Clean the TV with a dry and soft cloth. Do not use benzene, thinner, or any other chemicals to clean the TV. Do not scratch the picture tube.</p>
 <p>Do not pull the power cord to disconnect the TV. Pull it out by the plug. Disconnect the TV if you are not going to use it for several days.</p>	 <p>Do not plug in too many appliances to the same power socket. Do not damage the power cord.</p>
 <p>Do not open the cabinet and the rear cover of the TV. Refer servicing to qualified personnel.</p>	 <p>Do not install the TV in hot, humid or excessively dusty places.</p>

Using Your New TV

Getting Started

Step 1

Connect the antenna

If you wish to connect a VCR, see the "Connecting a VCR" diagram below.

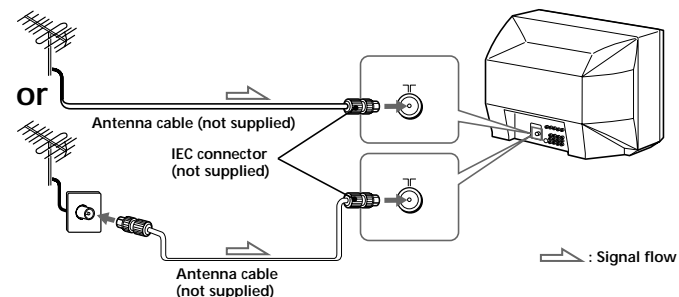

CAUTION

Do not connect the power cord until all other connections are complete; otherwise, a minimal current leakage through the antenna and/or other terminals to the ground could occur.

Connecting a VCR

To play a video tape, press  (see page 10).

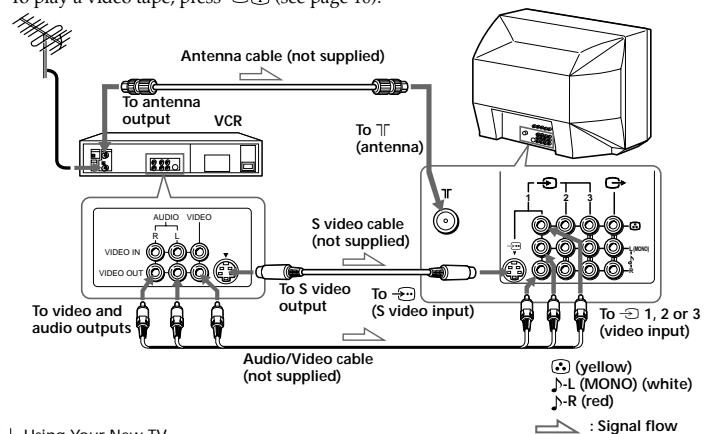

Notes

- If you connect a monaural VCR, connect the yellow plug to (the yellow jack) and the black plug to L (MONO) (the white jack).
- If you connect a VCR to the (antenna) terminal, preset the signal output from the VCR to the program number 0 on the TV.
- Do not have concurrent connections of video equipment to the 3 (video input) jacks at the front and the 3 (video input) jacks at the rear of your TV; otherwise, the picture will not be displayed properly on the screen.
- When both the (S video input) and 1 (video input) are connected, the (S video input) is automatically selected. To view the video input to 1 (video input), disconnect the S video cable.

Step 2

Insert the batteries into the remote

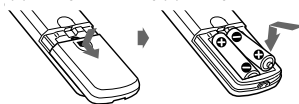

Note

- Do not use old batteries or different types of batteries together.

Step 3

Preset the channels automatically

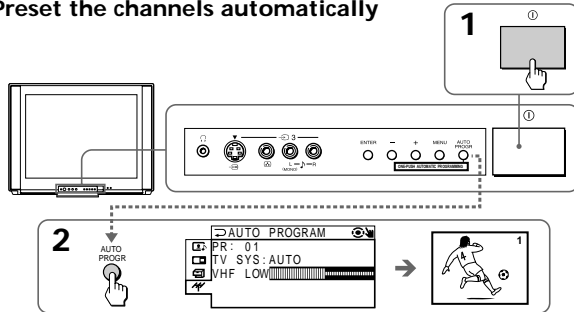

Tip

- To stop the automatic channel presetting, press MENU twice.

Note

- If your TV has preset an unwanted channel or cannot preset a particular channel, then preset your TV manually (see page 33).

Now You Are Ready . . .

To watch your TV, see page 9.

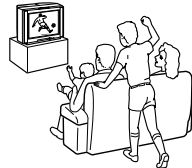

Connecting optional components

You can connect optional audio/video components, such as a VCR, multi disc player, camcorder, video game, or stereo system. To watch and operate the connected equipment, see pages 10 and 21.

Connecting a camcorder/video game equipment using the (video input) jacks

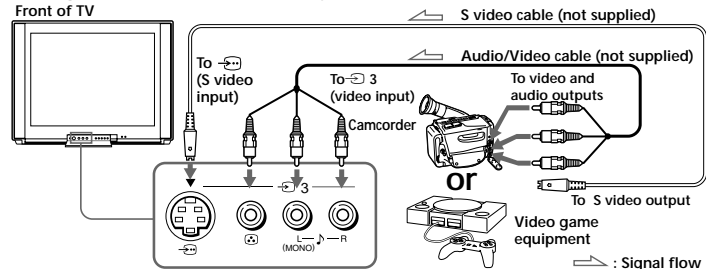

Notes

- You can also connect video equipment to the 1, 2, or 3 (video input) jacks at the rear of your TV.
- Do not have concurrent connections of video equipment to the 3 (video input) jacks at the front and the 3 (video input) jacks at the rear of your TV; otherwise, the picture will not be displayed properly on the screen.
- When both the (S video input) and 3 (video input) are connected, the (S video input) is automatically selected. To view the video input to 3 (video input), disconnect the S video cable.

Connecting audio/video equipment using the (monitor output) jacks

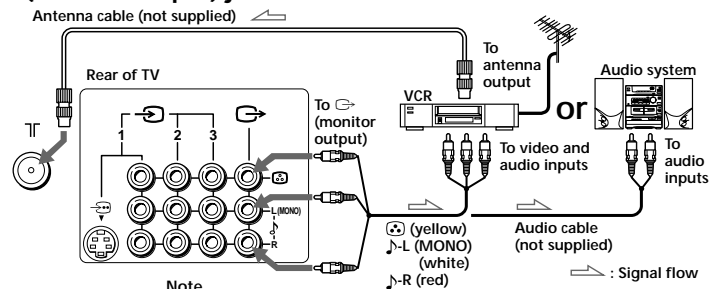

Note

- When connecting a monaural VCR, connect the yellow plug to (the yellow jack) and the black plug to L (MONO) (the white jack).

Connecting a DVD player

Connect 1, 2, or 3 (video input) (audio/video) connectors on your TV to LINE OUT on your DVD player.

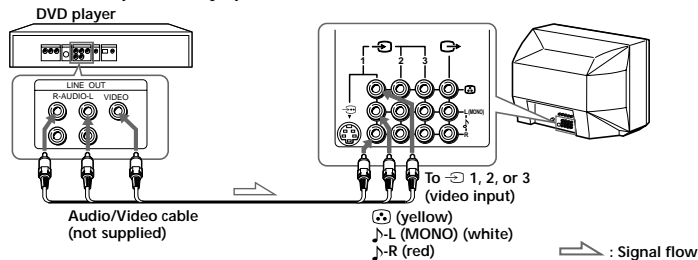

Connecting a DVD player with component video output connectors

- 1 Connect R and L under (component video input) on your TV to the LINE OUT, AUDIO R and L output connectors on your DVD player.
- 2 Using a component video cable, connect Y, C_B, and C_R under (component video input) on your TV to the COMPONENT VIDEO OUT Y, C_B, and C_R output connectors on your DVD player.

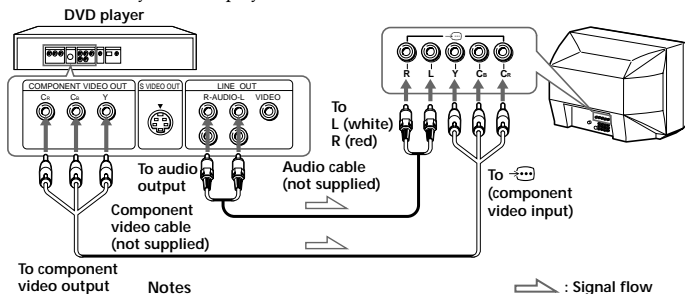

Notes

- Some DVD player terminals may be labeled differently:

Connect	To (on the DVD player)
Y (green)	Y
C _B (blue)	C _B , B-Y or P _B
C _R (red)	C _R , R-Y or P _R

- Since the high quality pictures on a DVD disc contain a lot of information, picture noise may appear. In this case, adjust the sharpness ("SHARP") in the PERSONAL ADJUST menu of the PICTURE MODE menu (see page 26).
- Connect your DVD player directly to your TV. Connecting the DVD player through other video equipment will cause unwanted picture noise.

Using Your New TV | 7

Using Your New TV

Securing the TV

To prevent the TV from falling, secure the TV using one of the following methods:

- A** With the supplied screws, attach the stabilizer band to the TV stand and to the rear of the TV using the provided hole.

OR

- B** Pass a cord or chain through the clamps and secure them to the rear of the TV and a wall or pillar.

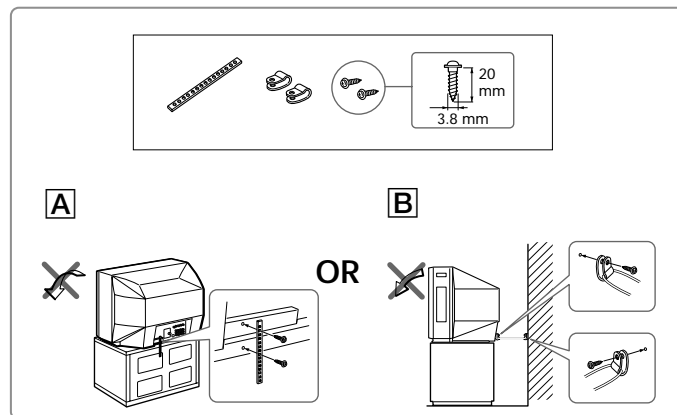

Note

- Use only the supplied screws. Use of other screws may damage the TV.

Watching the TV

This section explains various functions and operations used while watching the TV. Most operations can be done using the remote.

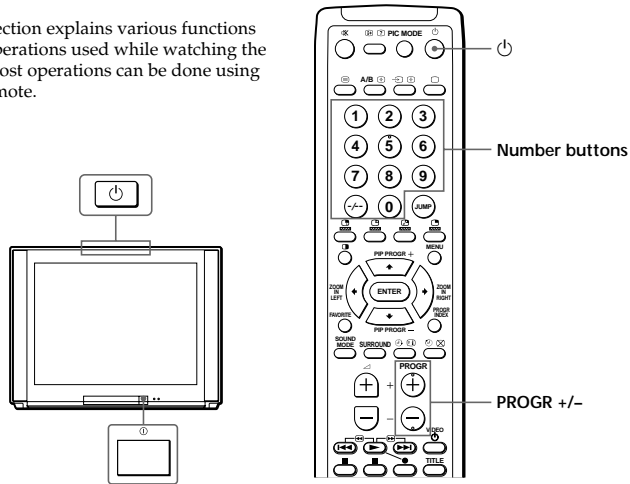

Using Your New TV

1 Press ⏻ to turn on the TV.

When the TV is in standby mode (the ⏻/⏻/⏻ indicator on the TV is lit red), press ⏻ on the remote or on the TV.

The PROGR +/-, ⏸ +/-, and ⏻ indicators on the TV light up.



2 Press PROGR +/- or the number buttons to select the TV channel.

For double digit numbers, press +/-, then the number (e.g., for 25, press +/-, then 2 and 5).

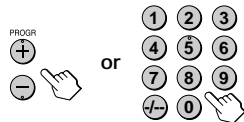

Watching the TV (continued)

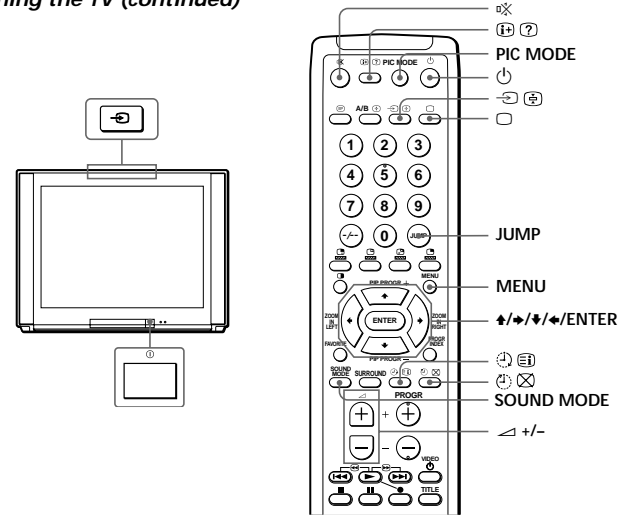

Additional tasks

To	Press
Turn off temporarily	⏻ The ⏻/⏻/⏻ indicator on the TV lights up red.
Turn off completely	Ⓜ on the TV.
Adjust the volume	⏸ +/-.
Mute the sound	⏸.
Watch the video input (VCR, camcorder, etc.)	Ⓜ (or Ⓜ on the TV) to select "VIDEO 1," "VIDEO 2," "VIDEO 3," or "DVD." To return to the TV screen, press Ⓜ (or Ⓜ on the TV).
Jump back to the previous channel	JUMP.
Display the on-screen information*	Ⓜ.



* The picture, sound, and either the program number or video mode are displayed. The on-screen display for the picture and sound information disappears after about 3 seconds.

continued

Changing the menu language

You can change the menu language as well as the on-screen language. For details on how to use the menu, see "Introducing the menu system" on page 23.

- 1 Press MENU.

- 2 Press ▲ or ▼ to select , then press ENTER.

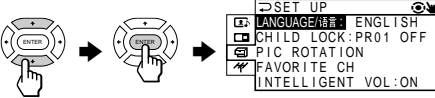
- 3 Make sure LANGUAGE/语言 is selected (highlighted), then press ENTER.

- 4 Press ▲ or ▼ to select 中文, then press ENTER.

The menu language changes to Chinese.

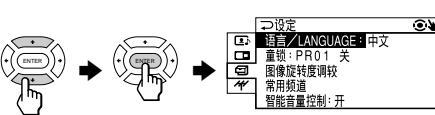

To return to the normal screen

Press MENU.

Using Your New TV

Watching the TV (continued)

Selecting the picture mode

Press PIC MODE repeatedly until the desired picture mode is selected.

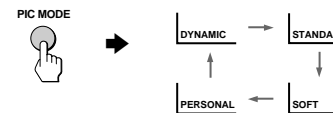

Select	To
DYNAMIC	receive high contrast pictures.
STANDARD	receive normal contrast pictures.
SOFT	receive mild contrast pictures.
PERSONAL	receive the last adjusted picture setting from the ADJUST option in the A/V CONTROL menu (see page 25).

Selecting the sound mode

Press SOUND MODE repeatedly until the desired sound mode is selected.

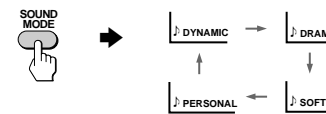

Select	To
DYNAMIC	listen to dynamic and clear sound that emphasizes both the low and high tones.
DRAMA	listen to sound that emphasizes voice and high tones.
SOFT	receive soft sound.
PERSONAL	receive the last adjusted sound setting from the ADJUST option in the A/V CONTROL menu (see page 25).

Tip

- You can also set the picture and sound modes using the menu (see "Changing the A/V CONTROL setting" on page 25).

continued

Setting the Wake Up timer

- 1 Press until the desired period of time appears.

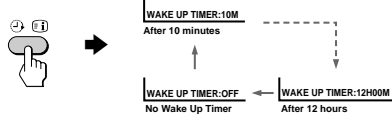

- 2 Select the TV channel or video mode you want to wake up to.
- 3 Press , or set the Sleep timer if you want the TV to turn off automatically. The /CD/ indicator on the TV lights up orange.

To cancel the Wake Up timer

Press until "WAKE UP TIMER: OFF" appears, or turn off the TV's main power.

Notes

- The Wake Up timer starts immediately after the on-screen display disappears.
- If no buttons or controls are pressed for more than two hours after the TV is turned on using the Wake Up timer, the TV automatically goes into standby mode. To resume watching the TV, press any button or control on the TV or the remote.

Setting the Sleep timer

Press until the desired period of time appears.

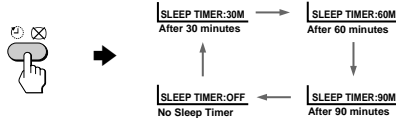

To cancel the Sleep timer

Press until "SLEEP TIMER: OFF" appears, or turn the TV off.

Using Your New TV

Advanced Operations

Viewing your favorite channels —FAVORITE CH

You can display seven favorite channels for quick and easy selection.

The last seven channels selected with the number buttons are displayed in AUTO mode. You can set up your own favorite channels in MANUAL mode under the FAVORITE CH menu (see "Changing the favorite channel setting" on page 31).

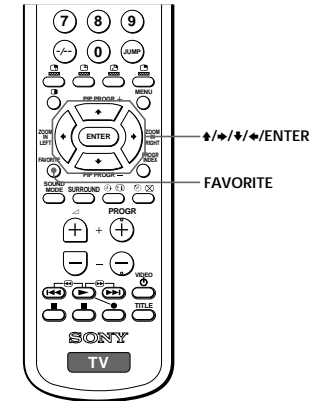

Selecting a favorite channel

- 1 Press FAVORITE.
The last seven channels selected with the number buttons appear.

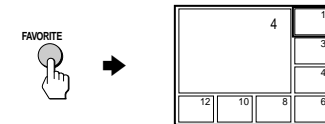

- 2 Press either , , , or to select the desired channel (e.g. PR 8), then press ENTER.

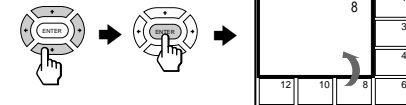

- 3 Press ENTER again.

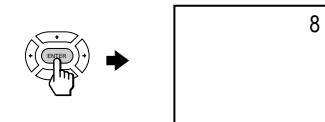

Note

- When you use your TV for the first time, seven preset channels appear.

Watching two programs at the same time

—PIP, TWIN

With the Picture-in-Picture (PIP) or TWIN pictures features, you can display a different TV program or video within or beside the main picture.

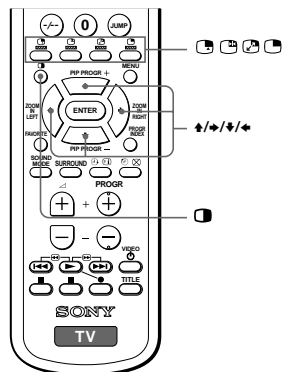

Displaying the PIP screen

Press .



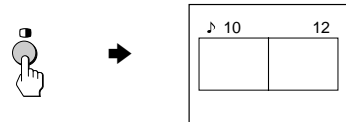

Displaying TWIN pictures

Press .



To return to the normal screen

Press  (when in the PIP screen) or  (when in the TWIN picture screen).









Tips

- You can also display the PIP screen or TWIN pictures using the menu (see “Changing the MULTI PICTURE setting” on page 27).
- You can change the position of the PIP screen (see “Changing the MULTI PICTURE setting” on page 27).

Advanced Operations

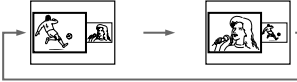

Watching two programs at the same time—PIP, TWIN (continued)

Additional PIP/TWIN pictures tasks

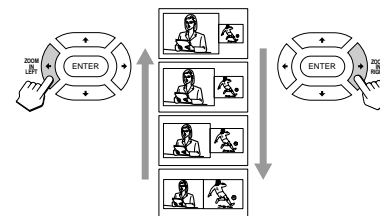
To	Press
change a TV program in the PIP screen or in the right TWIN picture	 or  . For a video input, press  .
swap pictures between the main and PIP screens	 
freeze the PIP screen	 To unfreeze the screen, press the button again.
swap the right and left pictures of the TWIN pictures	 
change the screen size of the TWIN pictures	ZOOM IN LEFT  to increase the left screen size. ZOOM IN RIGHT  to increase the right screen size.



Notes

- The  button does not function in the TWIN pictures mode.
- When you display a video input on the PIP screen at a faster/slower speed, the picture may be disrupted depending on the VCR type.
- If you display different color systems on the main screen and the PIP screen, the size of the PIP screen may be different and the PIP picture may be disrupted. This does not indicate a malfunction of the TV.
- In the TWIN picture screen, you can only operate and hear the sound of the main left screen (♪ appears on the screen).
- When the  button is pressed, the TV screen flickers or goes blank for about one second before the TWIN pictures appear. This does not indicate a malfunction of the TV.

continued

Displaying multiple programs —PROGRAM INDEX

The PROGRAM INDEX feature displays all of the preset TV programs and the video inputs on twelve or seven sub screens for direct selection.

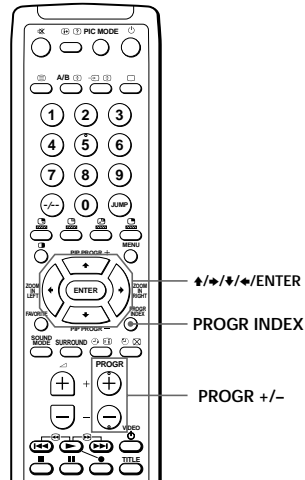

Press PROGR INDEX.

The first twelve preset programs appear one by one, clockwise from the upper left corner.

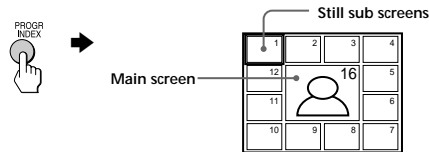

When the number of the preset TV programs is less than seven, the first seven preset programs appear one by one, clockwise from the upper right corner.

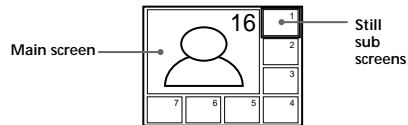

- Tip**
- When you press the PROGR INDEX button in the TWIN pictures mode, the left picture appears as the main screen of the PROGRAM INDEX mode.

continued

Displaying multiple programs—PROGRAM INDEX (continued)

To view the next or the previous twelve preset programs

This works only when the number of the preset TV programs is more than twelve.

Press PROGR +/- on the remote or the TV.

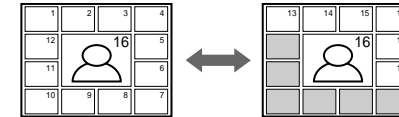

To select the desired program directly from the sub screens

1 Press either \uparrow , \rightarrow , \downarrow , or \leftarrow to move the frame to the screen of the program you want to watch.

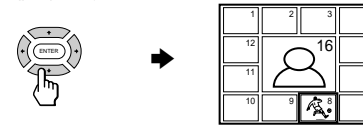

2 Press ENTER.

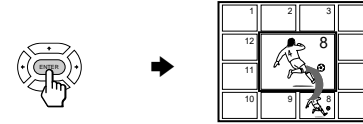

3 Press ENTER again.

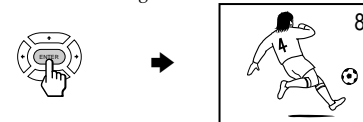

Tips

- You can also move the frame by pressing the +/- buttons on the TV. Press + to move the frame clockwise; press - to move the frame counterclockwise.
- Pressing the number buttons directly displays the program.

To return to the normal screen

Press PROGR INDEX again, or:

- 1 Select "PROGR INDEX" from the MULTI PICTURE menu.
- 2 Press ENTER.

Tip

- You can also display multiple programs using the menu (see "Changing the MULTI PICTURE setting" on page 27).

Note

- When displaying multiple programs, only the sound of the main screen is heard.

Listening with surround sound

The surround feature enables you to enjoy the sound effects of a concert hall or movie theater.

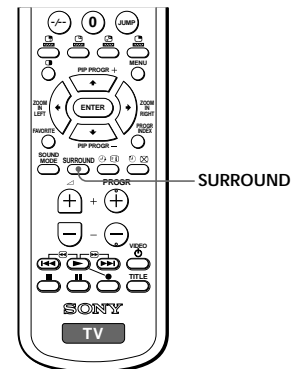

Press SURROUND repeatedly until you receive the desired surround sound.

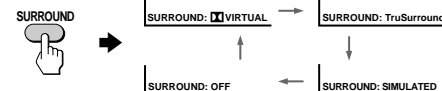

Select	To
VIRTUAL	listen to Dolby* Surround encoded sound.
TruSurround	listen to the surround sound that spreads out to the rear of a room.
SIMULATED	listen to monaural sound with a stereo-like effect.
OFF	turn off the surround sound.

• SIMULATED uses SRS (MONO).

The Virtual Dolby Surround of this model consists of Dolby Pro Logic and TruSurround.

* Manufactured under license from Dolby Laboratories Licensing Corporation. DOLBY, the double-D symbol and "PRO LOGIC" are trademarks of Dolby Laboratories Licensing Corporation.

"**TruSurround**" is a trademark of SRS Labs, Inc. SRS and the SRS symbol are registered trademarks of SRS Labs, Inc. in the United States and selected foreign countries. SRS and TruSurround are incorporated under license from SRS Labs, Inc. and are protected under United States Patent Nos. 4,748,669 and 4,841,572 with numerous additional issued and pending foreign patents."

Operating optional components

You can use the supplied remote to operate Sony video equipment such as Beta, 8 mm, VHS, MDP, CD, or DVD.

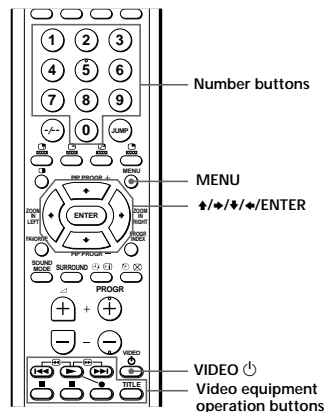

Setting up the remote to work with other connected equipment

While holding down VIDEO , press the following number combinations to enter the equipment's code number (see the chart below).

For example, to operate a Sony 8 mm VCR:

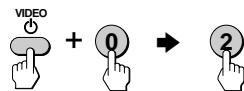

Code numbers for Sony video equipment

To control	Hold down VIDEO  and press
DVD	00
VTR1 (Beta)	01
VTR2 (8 mm)	02
VTR3 (VHS)	03
MDP	04
CD	06
MD	07











Notes

- If your video equipment is furnished with a COMMAND MODE selector, set this selector to the same position as the setting code.
- If the equipment does not have a certain function, the corresponding button on the remote will not operate.
- When you remove the batteries, the code number may revert to the factory setting.









continued

Operating optional components (continued)







Operating a VCR using the remote

To	Press
turn on/off	VIDEO 
record	 while pressing 
play	
stop	
fast forward (▶▶)	
rewind the tape (◀◀)	
pause	
search the picture forward (▶▶) or backward (◀◀)	 or  during playback. Release to resume normal playback.









Operating a DVD player using the remote

To	Press
turn on/off	VIDEO 
play	
stop	
pause	
step through different tracks of an audio disc	 to step forward or  to step backward.
display the Title menu	TITLE
display the menu	MENU while holding down 
select the menu item	 while holding down 

Operating an MDP using the remote

To	Press
turn on/off	VIDEO 
play	
stop	
pause	
Step through different tracks of a disc	 to step forward or  to step backward.

Operating a CD/MD using the remote

To	Press
turn on/off	VIDEO 
play	
stop	
pause	
go to the next/previous tracks	 or 
go forward (▶▶)/backward (◀◀) quickly in a track	 or  while holding down 

Adjusting Your Setup (MENU)

Introducing the menu system

The MENU button lets you open a menu and change the settings of your TV. The following is an overview of the menu system.

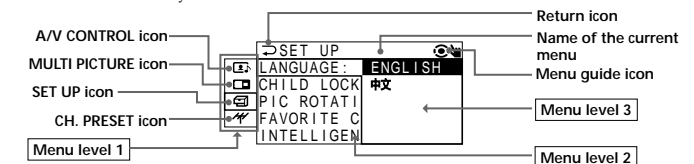

Level 1	Level 2	Level 3/Function
A/V CONTROL	PICTURE MODE	Select the picture mode: DYNAMIC → STANDARD → SOFT → PERSONAL → ADJUST
	ADJUST	Adjust the PERSONAL option: PICTURE → COLOR → BRIGHT → HUE → SHARP
	SOUND MODE	Select the sound mode: DYNAMIC → DRAMA → SOFT → PERSONAL → ADJUST
	ADJUST	Adjust the PERSONAL option: BASS → TREBLE → BALANCE → BBE*
	SURROUND	Select the surround mode: □ VIRTUAL → TruSurround → SIMULATED → OFF
MULTI PICTURE	PIP POSITION	Change the position of the sub screen.
	PIP	Activate or deactivate the PIP feature.
	SWAP	Swap the pictures between the main and sub screens.
	TWIN	Display a TV program or video beside the main screen.
	PROGRAM INDEX	Display all the preset TV programs at the same time.
SET UP	LANGUAGE/语言	Change the menu language: ENGLISH ↔ 中文 (CHINESE)
	CHILD LOCK	Lock out specific channels.
	PIC ROTATION	Rotate the picture.
	FAVORITE CH	Set favorite channels.
	INTELLIGENT VOL	Adjust the volume automatically.
CH PRESET	AUTO PROGRAM	Preset channels automatically.
	MANUAL PROGRAM	Preset channels manually.
	SKIP	Skip unwanted or unused program numbers.
	TV SYS	Select the TV system: B/G → I → D/K → M
	COL SYS	Select the color system: AUTO → PAL → SECAM → NTSC3.58 → NTSC4.43

* The BBE is manufactured by Sony Corporation under license from BBE Sound, Inc. It is covered by U.S. Patent No. 4,638,258 and No. 4,482,866. The word "BBE" and the BBE symbol are the trademarks of BBE Sound, Inc.

continued

Introducing the menu system (continued)

How to use the menu

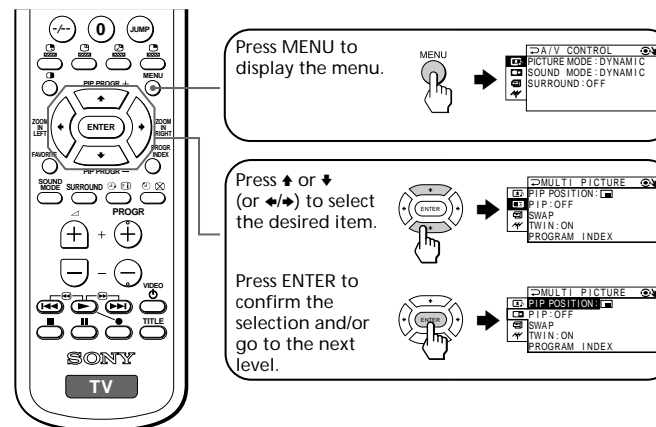

Other menu operations

To	Press
Adjust the setting value	▲/▼ or ◀/▶
Move to the next/previous menu level	▶ or ◀
Cancel the menu	MENU

Tips

- If you want to exit from Menu level 2 to Menu level 1, press ▲ or ▼ until the return icon (↶) is highlighted, then press ENTER.
- The MENU, ENTER, and +/- buttons on the TV can also be used for the operations above.

Note

- If more than 60 seconds elapse between entries, the menu screen automatically disappears.

Changing the A/V CONTROL setting

The A/V CONTROL menu allows you to adjust the picture and sound settings.

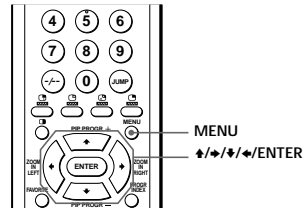

- 1 Press MENU.



- 2 Press ▲ or ▼ to select , then press ENTER.

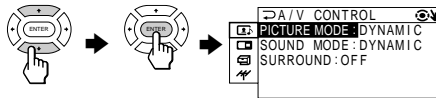

- 3 Press ▲ or ▼ to select either PICTURE MODE, SOUND MODE, or SURROUND, then press ENTER.

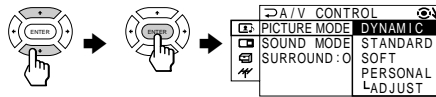

- 4 Press ▲ or ▼ to select the desired option, then press ENTER.

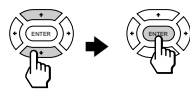

For	Select
PICTURE MODE	either DYNAMIC, STANDARD, SOFT, PERSONAL*, or ADJUST.
SOUND MODE	either DYNAMIC, DRAMA, SOFT, PERSONAL*, or ADJUST.
SURROUND	either  VIRTUAL, TruSurround, SIMULATED, or OFF.

* When the PERSONAL mode is selected, the last adjusted picture/sound settings from the ADJUST option are received (see page 26).

Tip

- For details on the options under the PICTURE/SOUND MODE and SURROUND modes, see pages 12 and 20 respectively.

To return to the normal screen

Press MENU.

Changing the A/V CONTROL setting (continued)

Adjusting the ADJUST options under PICTURE MODE

- 1 Press ▲ or ▼ to select the desired item (e.g., COLOR), then press ENTER.

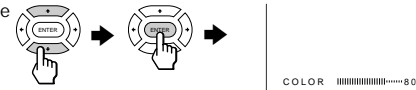

- 2 Adjust the value according to the following table, then press ENTER.

For	Press ▲/▼ to	Press ▲/▼ to
PICTURE	decrease picture contrast	increase picture contrast
COLOR	decrease color intensity	increase color intensity
BRIGHT	darken the picture	brighten the picture
HUE*	increase red picture tones	increase green picture tones
SHARP	soften the picture	sharpen the picture

* You can adjust HUE for the NTSC color system only.

- 3 Repeat the above steps to adjust other items.

The adjusted settings will be received when you select PERSONAL.

Adjusting the ADJUST options under SOUND MODE

- 1 Press ▲ or ▼ to select the desired item (e.g., BALANCE), then press ENTER.

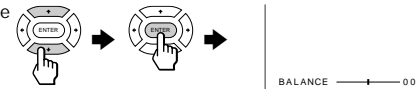

- 2 Adjust the value according to the following table, then press ENTER.

For	Press
BASS	▲/▼ to decrease the bass, ▲/▼ to increase the bass
TREBLE	▲/▼ to decrease the treble, ▲/▼ to increase the treble
BALANCE	▲/▼ to increase the left speaker's volume, ▲/▼ to increase the right speaker's volume
BBE	▲/▼ to select HIGH, LOW, or OFF. BBE can produce clear sound.

- 3 Repeat the above steps to adjust other items.

The adjusted settings will be received when you select PERSONAL.

Tip

- For details on the menu system and how to use the menu, refer to "Introducing the menu system" on page 23.

Changing the MULTI PICTURE setting

The MULTI PICTURE menu allows you to use the Picture-in-Picture (PIP), TWIN pictures, or PROGRAM INDEX features.

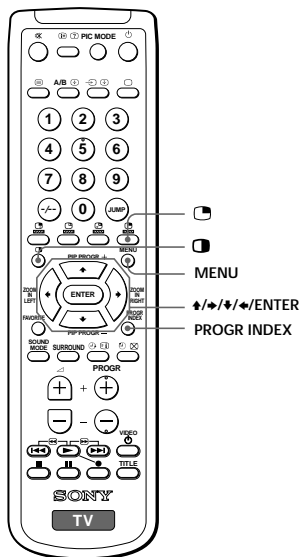

- 1 Press MENU.

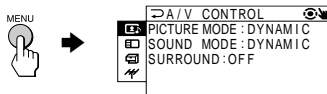

- 2 Press \uparrow or \downarrow to select \square , then press ENTER.

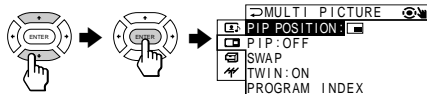

Changing the MULTI PICTURE setting (continued)

- 3 Press \uparrow or \downarrow to select the desired option (see the table below), then press ENTER.

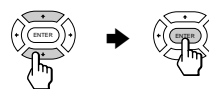

Select	To
PIP POSITION	change the position of the PIP screen. Press \uparrow or \downarrow to select the desired position, then press ENTER.
PIP	display the PIP screen within the main picture. Press \uparrow or \downarrow to select "ON," then press ENTER. To cancel, press \square or select "OFF," then press ENTER.
SWAP	swap the main and PIP screens, or right and left pictures of the TWIN pictures.
TWIN	display a different TV program or video beside the main picture. Press \uparrow or \downarrow to select "ON," then press ENTER. To cancel, press \square or select "OFF," then press ENTER.
PROGRAM INDEX	view multiple programs on the sub-screens. To cancel, press PROGRAM INDEX.



To return to the normal screen

Press MENU.

Tip

- For details on the menu system and how to use the menu, see "Introducing the menu system" on page 23.

continued

Changing the SET UP setting

The SET UP menu allows you to: change the menu language (see page 11), block channels, adjust the picture position, program your favorite channels, and adjust the volume automatically.

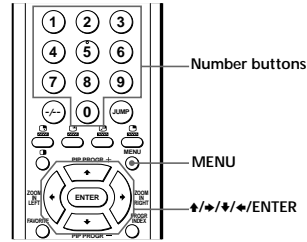

- 1 Press MENU.



- 2 Press \uparrow or \downarrow to select , then press ENTER.

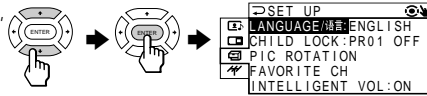

- 3 Press \uparrow or \downarrow to select the desired option, then press ENTER.

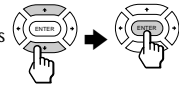

Select	To
LANGUAGE/语言	change the menu language (see page 11).
CHILD LOCK	block channels (see page 30).
PIC ROTATION	adjust the picture position when it is not aligned with the TV screen. Press \rightarrow or \leftarrow to adjust the position clockwise, then press ENTER. Press \downarrow or \uparrow to adjust the position counterclockwise, then press ENTER.
FAVORITE CH	select your favorite channels (see page 31).
INTELLIGENT VOL	adjust the volume of each TV program automatically. Press \uparrow or \downarrow to select "ON," then press ENTER. To cancel, select "OFF," then press ENTER.

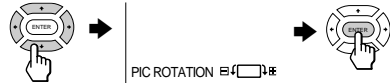

To return to the normal screen

Press MENU.

continued

Adjusting Your Setup (MENU) | 29

Changing the SET UP setting (continued)

Blocking the channels (CHILD LOCK)

- 1 After selecting CHILD LOCK, press either \uparrow or \downarrow , or the number buttons (or PROGR +/-) to select the desired channel (e.g. PR 06), then press ENTER.

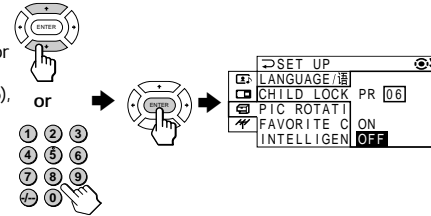

- 2 Press \uparrow or \downarrow to select ON, then press ENTER.

To unlock the channel, select OFF.

The lock symbol (🔒) appears on the screen when ON is selected.

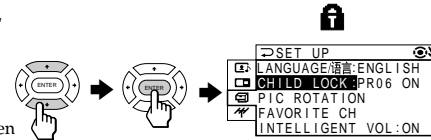

If a locked channel is selected, the lock symbol appears on the screen.



- 3 Repeat steps 1 and 2 to lock other channels.

To return to the normal screen

Press MENU.

30 | Adjusting Your Setup (MENU)

Changing the favorite channel setting

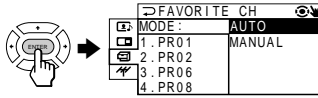
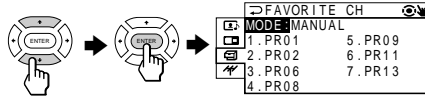
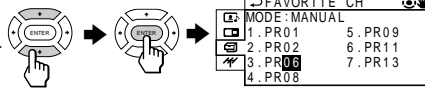
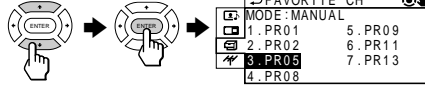
- After selecting FAVORITE CH, make sure MODE is selected, then press ENTER.
 
- Press ▲ or ▼ to select MANUAL, then press ENTER.
 
- Press ▲ or ▼ to select the program you want to change, then press ENTER.
 
- Press ▲ or ▼ to change the number, then press ENTER.
 
- Repeat steps 3 and 4 to set other channels.

To return to the normal screen

Press MENU.

Note

- If you press the PROGR +/- buttons or number buttons in step 4 above, the TV will display the channel immediately.

Changing the CH PRESET setting

The CH PRESET menu allows you to adjust the setup of your TV. For example, you can manually tune in a channel with a weak signal that fails to be tuned in by automatic presetting.

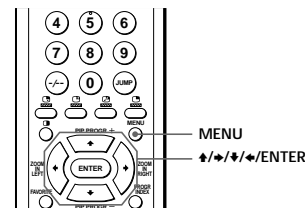

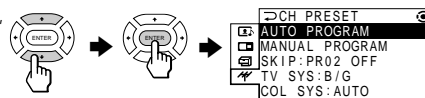
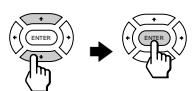
- Press MENU.
 
- Press ▲ or ▼ to select CH PRESET, then press ENTER.
 
- Press ▲ or ▼ to select the desired option, then press ENTER.
 

Select	To
AUTO PROGRAM	preset channels automatically.
MANUAL PROGRAM	preset channels manually. See "Presetting channels manually" on page 33.
SKIP	skip unwanted or unused channels. 1 Press either ▲ or ▼, or the number buttons (or PROGR +/-) until the unused or unwanted channel number appears, then press ENTER. 2 Select "ON," then press ENTER. 3 To disable other channels, repeat steps 1 and 2. To restore the skipped channel, select "OFF" in step 2.
TV SYS	select the TV system.
COL SYS	select the color system. Normally, set this to "AUTO."

To return to the normal screen

Press MENU.

Tip

- For details on the menu system and how to use the menu, refer to "Introducing the menu system" on page 23.

Presetting channels manually

1 After selecting MANUAL PROGRAM, select the program number to which you want to preset a channel.

(1) Make sure "PR" is selected, then press ENTER.

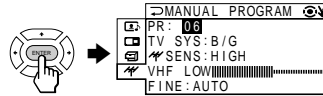

(2) Press ▲ or ▼ until the program number you want to preset (e.g., program number 10) appears on the menu, then press ENTER.

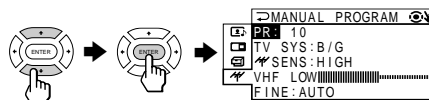

Tip

- You can also select the program number with the Progr +/- or number buttons.

2 Select the desired channel.

(1) Press ▲ or ▼ to select either VHF LOW, VHF HIGH, or UHF, then press ENTER.

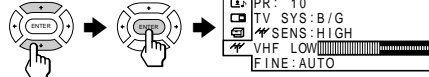

(2) Press ▲ or ▼ until the desired channel's broadcast appears on the TV screen, then press ENTER.

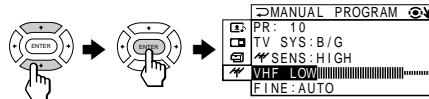

3 If the sound of the desired channel is abnormal, select the appropriate TV system.

(1) Press ▲ or ▼ to select TV SYS, then press ENTER.

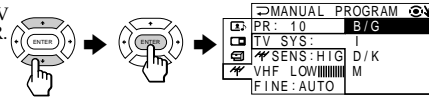

(2) Press ▲ or ▼ until the sound becomes normal, then press ENTER.

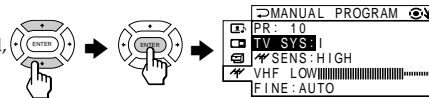

continued

Changing the CH PRESET setting (continued)

4 If you are not satisfied with the picture and sound quality, you may be able to improve them by using the FINE tuning feature.

(1) Press ▲ or ▼ to select FINE, then press ENTER.

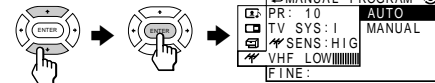

(2) Press ▲ or ▼ to select MANUAL, then press ENTER.

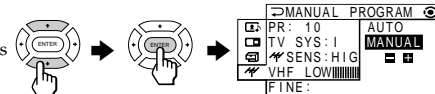

(3) Press either ▲, ▼, ▲, ▼, or ◀ until the picture and sound quality are optimal, then press ENTER.

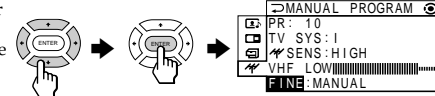

The + or - icon on the menu flashes while tuning.

5 If the TV signal is too strong and the picture is distorted, you can adjust the TV reception sensitivity.

(1) Press ▲ or ▼ to select SENS, then press ENTER.

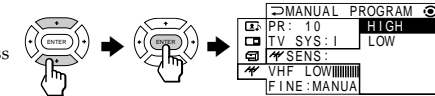

(2) Press ▲ or ▼ to select LOW, then press ENTER.

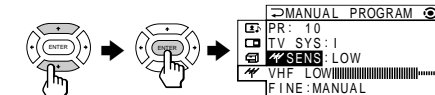

To return to the normal screen

Press MENU.









Notes

- The TV system (TV SYS) and the TV reception sensitivity (SENS) settings are memorized for each program number.
- If you preset a locked channel, that channel will be unlocked.

Additional Information

Troubleshooting







If you have any problem while viewing your TV, please check the following troubleshooting guide. If the problem persists, contact your Sony dealer.

Symptom	Solutions	Possible cause
Snowy picture 	<ul style="list-style-type: none"> Check the antenna cable and connection on the TV, VCR, and at the wall. (page 4) Display the CH PRESET menu and select "MANUAL PROGRAM" to preset the channel again. (page 33) 	<ul style="list-style-type: none"> The connection is loose or the cable is damaged. The channel presetting is inappropriate or incomplete.
Noisy sound 	<ul style="list-style-type: none"> Check the antenna type (VHF/UHF). Contact a Sony dealer for advice. Adjust the antenna direction. Contact a Sony dealer for advice. Try using a booster. 	<ul style="list-style-type: none"> The antenna type is inappropriate. The antenna direction needs adjustment. Signal transmission is low.
Distorted picture 	<ul style="list-style-type: none"> Display the CH PRESET menu and select "MANUAL PROGRAM." Then, select "SENS: LOW." (page 34) Turn off or disconnect the booster if it is in use. 	<ul style="list-style-type: none"> Broadcast signals are too strong.
Noisy sound 		
Good picture 	<ul style="list-style-type: none"> If the sound of all the channels is noisy, display the CH PRESET menu and select "AUTO PROGRAM" to preset the channels again. (page 32) If the sound of some channels is noisy, select the channel, then display the CH PRESET menu and select the appropriate TV system (TV SYS). (page 33) 	<ul style="list-style-type: none"> The TV system setting is inappropriate.
Noisy sound 		
No picture 	<ul style="list-style-type: none"> Check the power cord, antenna, and the VCR connections. Press (power). Press (main power) on the TV to turn off the TV for about five seconds, then turn it on again. 	<ul style="list-style-type: none"> The power cord, antenna, or VCR is not connected. The TV is not turned on.
No sound 		

Additional Information

continued

Troubleshooting (continued)

Symptom	Solutions	Possible cause
Good picture 	<ul style="list-style-type: none"> Press \triangle + to increase the volume level. Press M to cancel the muting. 	<ul style="list-style-type: none"> The volume level is too low. The sound is muted.
No sound 		
Dotted lines or stripes 	<ul style="list-style-type: none"> Do not use a hair dryer or other equipment near the TV. Adjust the antenna direction for minimum interference. Contact a Sony dealer for advice. 	<ul style="list-style-type: none"> There is local interference from cars, neon signs, hair dryers, power generators, etc.
Double images or "ghosts" 	<ul style="list-style-type: none"> Use a highly directional antenna. Use the fine tuning (FINE) function. (page 34) Adjust the antenna direction. Contact a Sony dealer for advice. Turn off or disconnect the booster if it is in use. 	<ul style="list-style-type: none"> Broadcast signals are reflected by nearby mountains or buildings. The antenna direction needs adjustment. Use of a booster is inappropriate.
No color 	<ul style="list-style-type: none"> Display the A/V CONTROL menu and select "ADJUST" in PICTURE MODE, then adjust the COLOR level. (page 26) Display the CH PRESET menu and check the color system (COL SYS) setting (usually set this to AUTO). (page 32) Adjust the antenna direction. Contact a Sony dealer for advice. 	<ul style="list-style-type: none"> The color level setting is too low. The color system setting is inappropriate. The antenna direction needs adjustment.
Abnormal color patches 	<ul style="list-style-type: none"> Locate external speakers or other equipment away from the TV. Do not move the TV while the TV is turned on. Press (main power) on the TV to turn off the TV for about five minutes, then turn it on again. 	<ul style="list-style-type: none"> The magnetic disturbance from external speakers or other equipment, or the direction of the earth's magnetic field may affect the TV.

Symptom	Solutions	Possible cause
Picture slant 	<ul style="list-style-type: none"> Display the SET UP menu and adjust "PIC ROTATION" so that the picture is aligned to the TV screen. (page 29) 	<ul style="list-style-type: none"> Terrestrial magnetism is affecting your TV set.
Lines moving across the TV screen.	<ul style="list-style-type: none"> Use the fine tuning (FINE) function. (page 34) 	<ul style="list-style-type: none"> There is interference from external sources, e.g., heavy machineries, nearby broadcast station.
The ⏻ indicator on your TV flashes red a number of times between 3-second intervals.	<ul style="list-style-type: none"> Contact your nearest Sony service center. (page 38) 	<ul style="list-style-type: none"> Your TV may need service.
TV cabinet creaks.	—	<ul style="list-style-type: none"> Changes in room temperature sometimes make the TV cabinet expand or contract, causing a noise. This does not indicate a malfunction.
A small "boom" sound is heard when the TV is turned on.	—	<ul style="list-style-type: none"> The TV's demagnetizing function is working. This does not indicate a malfunction.

Self-diagnosis function

Your TV is equipped with a self-diagnosis function. If there is a problem with your TV, the ⏻ (standby) indicator flashes red. The number of times the ⏻ indicator flashes indicates the possible causes.

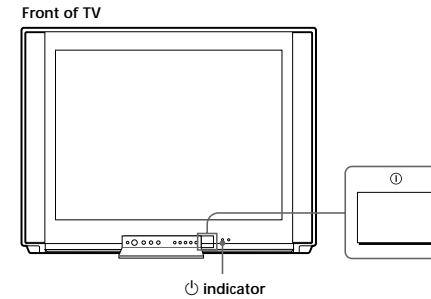

- 1 Check that the ⏻ indicator on your TV flashes red a number of times between 3-second intervals.
- 2 Count the number of times the ⏻ indicator flashes.
- 3 Press ⏻ (main power) to turn off your TV.
- 4 Inform your nearest Sony service center about the number of times the ⏻ indicator flashed. Be sure to note the model name and serial number located on the rear of your TV.

Identifying parts and controls

Refer to the pages indicated in parentheses () for details.

Front panel

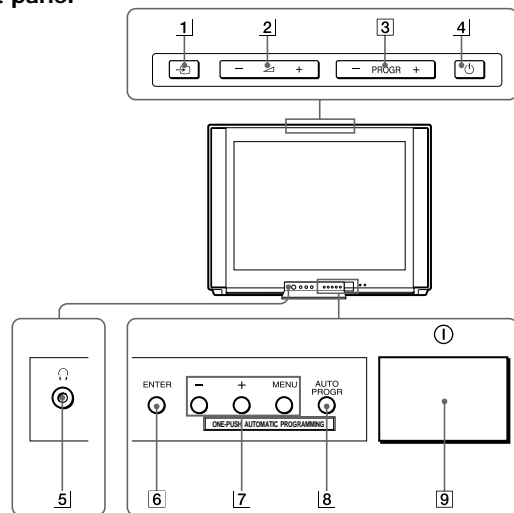

- 1 ⇄ (TV/video) button (10)
- 2 ▲/▼ (volume) buttons (10)
- 3 PROGR +/- (program) buttons (9)
- 4 ⏻ (power) button (9)
- 5 🎧 (headphone) jack
- 6 ENTER button (24)
- 7 MENU/+/- buttons (24)
- 8 AUTO PROGR (program) button (5)
- 9 Ⓜ (main power) button (9)

Identifying parts and controls (continued)

Remote control

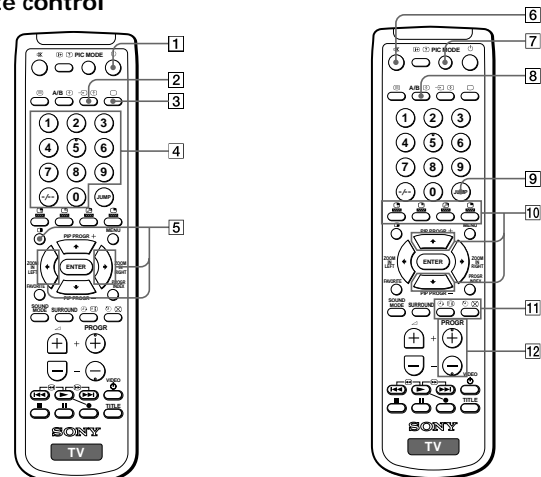

- 1 ⏻ (power) button (9)
- 2 ⇄ (video) button (10)
- 3 📺 (TV) button (10)
- 4 Number buttons (9)
- 5 TWIN pictures operation buttons (15 - 16)
 - (TWIN)
 - ◀ ZOOM IN LEFT
 - ▶ ZOOM IN RIGHT

- 6 🔇 (muting) button (10)
- 7 PIC MODE button (12)
- 8 A/B button (not used for KV-EF34M80)
- 9 JUMP button (10)
- 10 PIP operation buttons (15 - 16)
 - 📺 (TV/video)
 - 🧊 (freeze)
 - 🔄 (swap)
 - 📺 (PIP)
 - ↕—for changing PIP PROGR
- 11 Timer setting buttons (13)
 - 🕒 (wake up timer)
 - 🌙 (sleep timer)
- 12 PROGR +/- (program) buttons (9)

The names/symbols of buttons on the remote are indicated in different colors to represent the available functions.

Label color	Button function
White	For general TV and PROGRAM INDEX operations
Green	For Teletext operations
Yellow	For PIP operations

continued

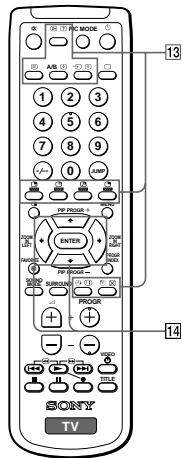

13 Teletext operation buttons (not used for KV-EF34M80)

- ☒ (text)
- ⊕ (enlarge)
- ⊗ (reveal)
- ⊞ (hold)
- ☐ Red
- ☐ Green
- ☐ Yellow
- ☐ Blue
- Ⓜ (index)
- ⊗ (text clear)

14 FAVORITE channel operation buttons (14) FAVORITE

- ⬅/➡/⬅/➡/ENTER

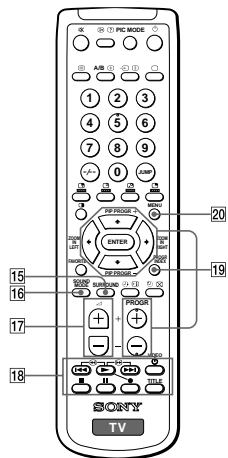

15 SURROUND button (20)
 16 SOUND MODE button (12)
 17 +/- (volume) buttons (10)
 18 DVD, VCR, MDP, CD, MD operation buttons (22)

- ▶▶/⏪ (fastforward/search forward)
- ▶ (play)
- ◀◀/⏩ (rewind/search backward)
- (record)
- (stop)
- ⏸ (pause)
- VIDEO ⏻ (power)
- TITLE

19 PROGRAM INDEX operation buttons (17 - 19)

- PROGR INDEX
- ⬅/➡/⬅/➡/ENTER
- PROGR +/-

20 MENU button (24)

SECTION 2 DISASSEMBLY

2-1. REAR COVER REMOVAL

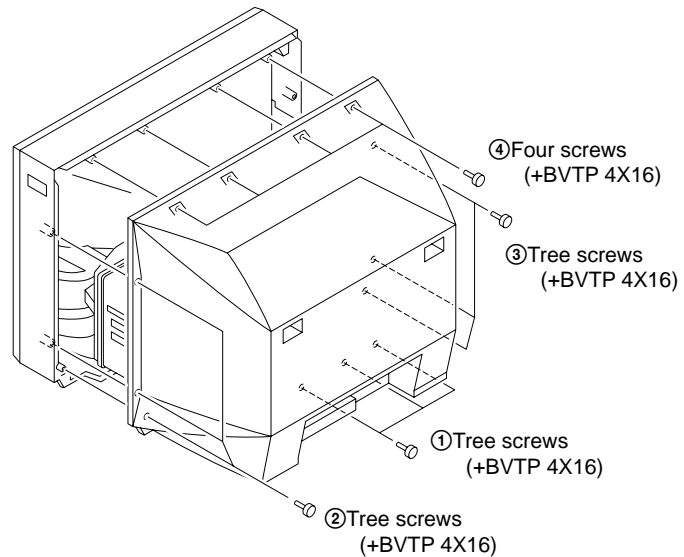

2-3. CHASSIS ASSY REMOVAL

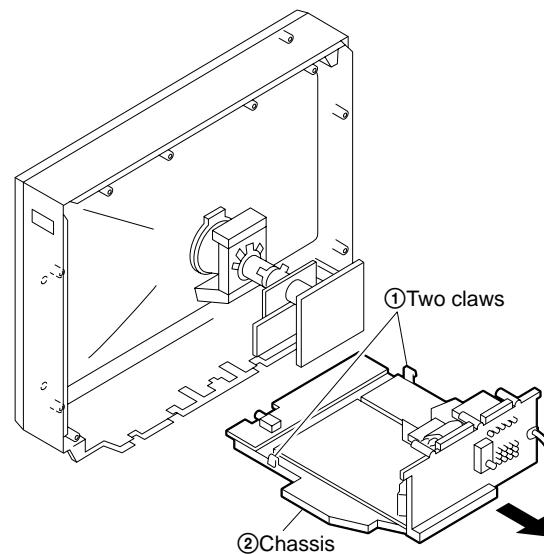

2-2. SPEAKER BOX REMOVAL

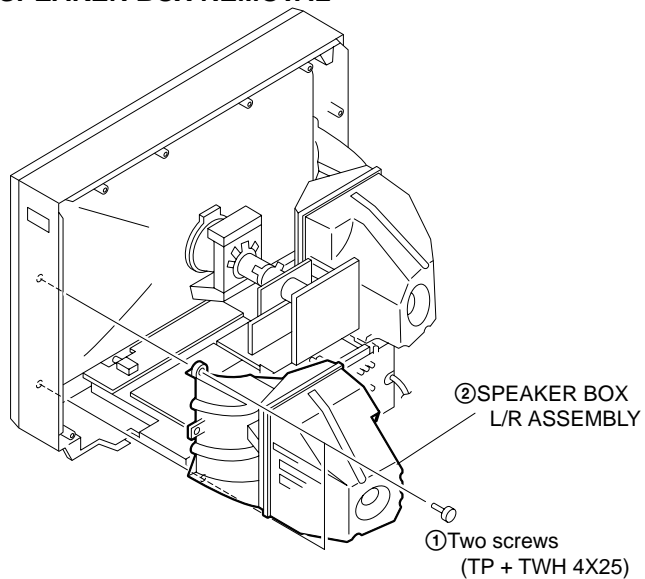

2-4. SERVICE POSITION

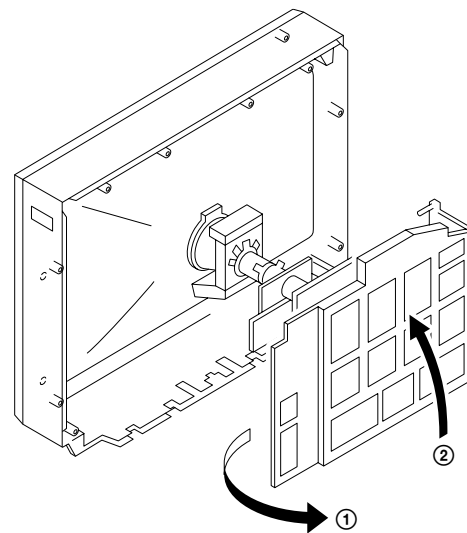

2-5. D2 AND DH BOARDS REMOVAL

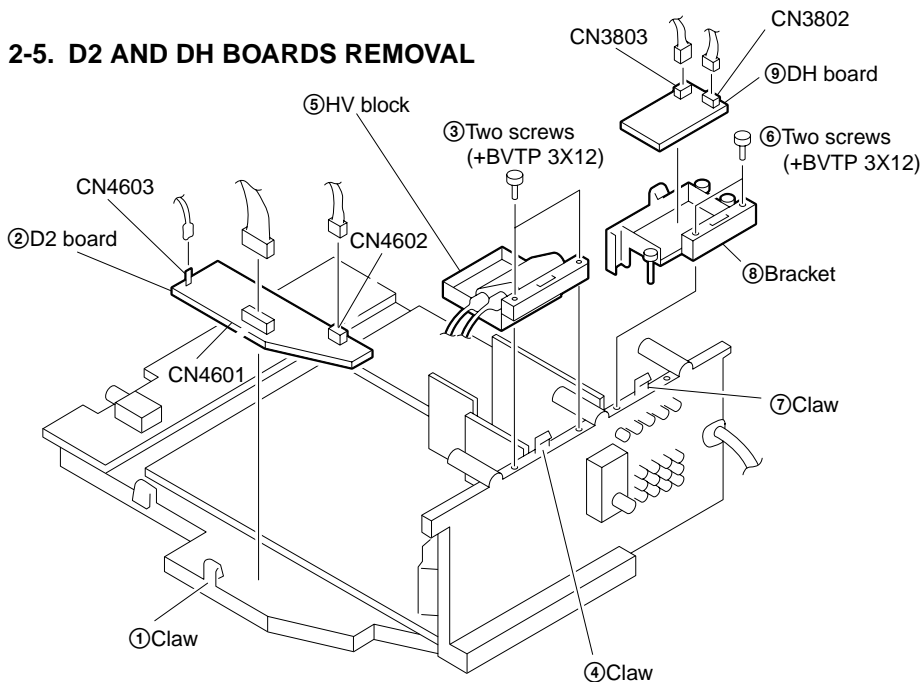

2-6. J1 BOARD AND RF SPLITTER REMOVAL

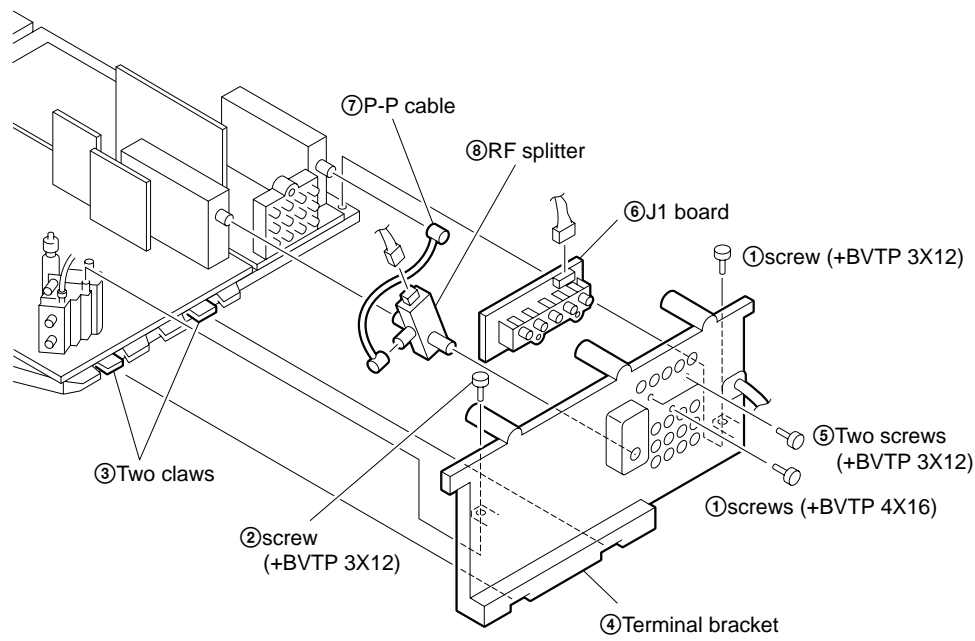

2-7. P BOARD REMOVAL

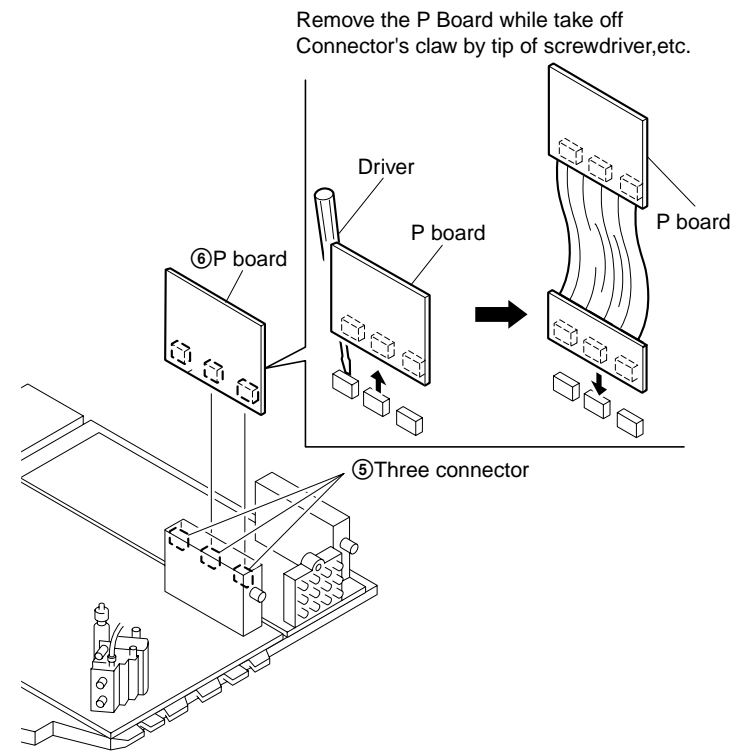

2-8. A AND B BOARDS REMOVAL

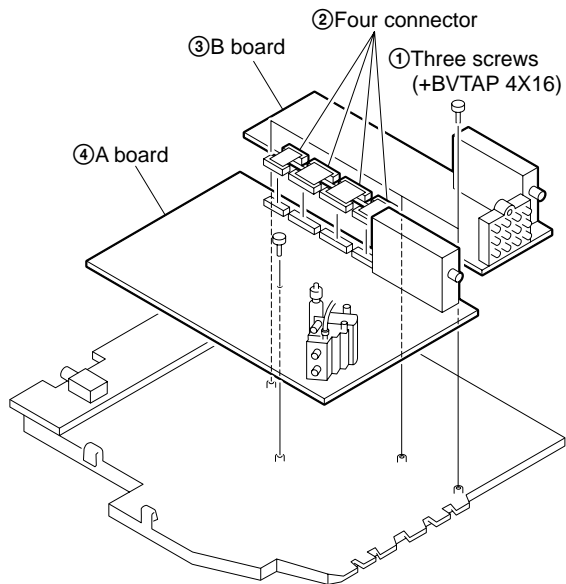

2-10. DEMAGNETIZATION COIL REMOVAL

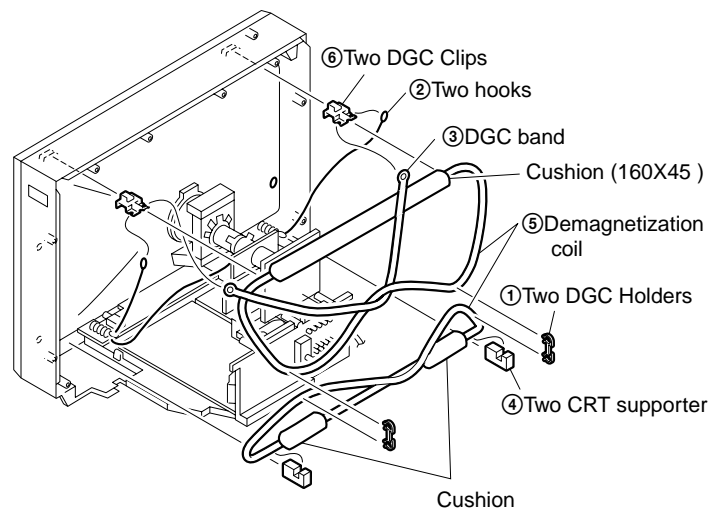

2-9. H1 BOARD REMOVAL

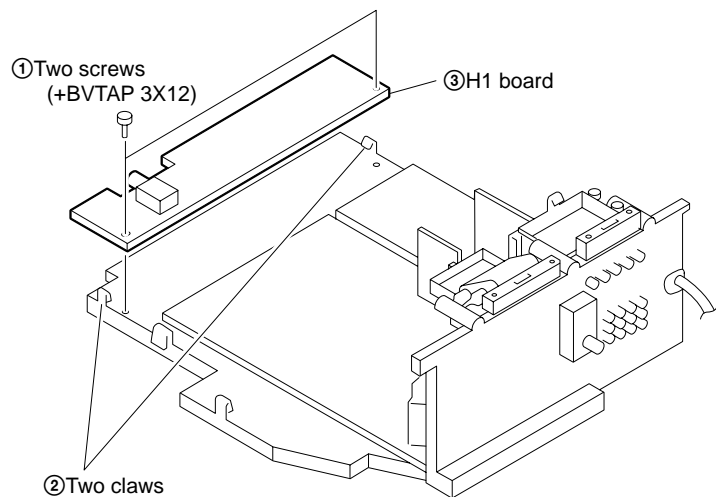

2-11. TOP SWITCH REMOVAL

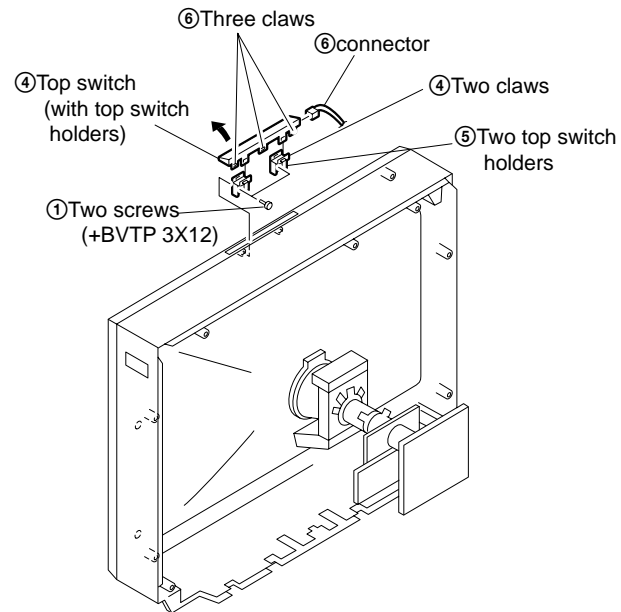

2-12. PICTURE TUBE REMOVAL

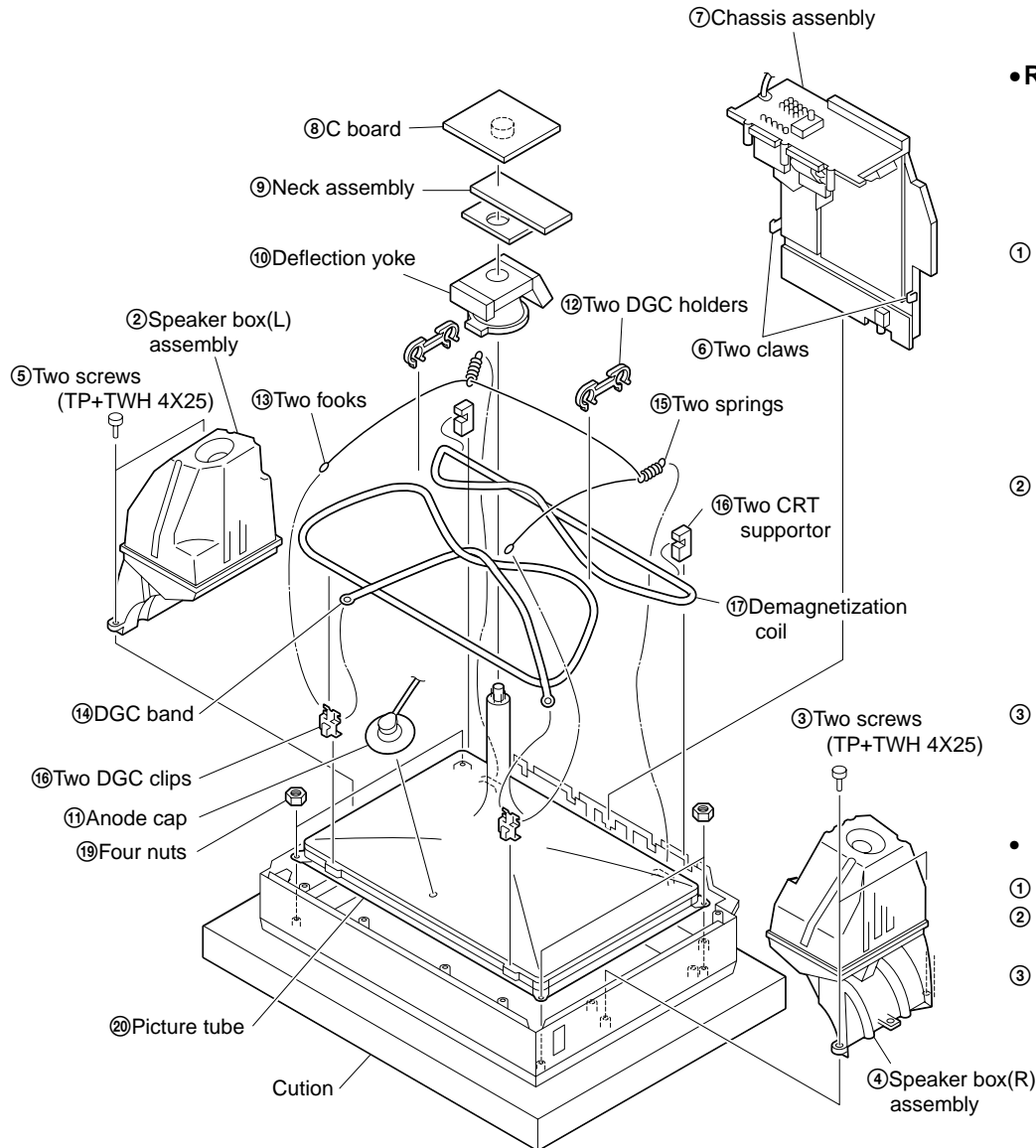

•REMOVAL OF ANODE-CAP

NOTE : After removing the anode, short circuit the anode of the picture tube and the anode cap to the metal chassis, CRT shield or carbon paint on the CRT.

•REMOVING PROCEDURES

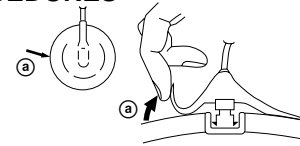

① Turn up one side of the rubber cap in the direction indicated by the arrow ①.

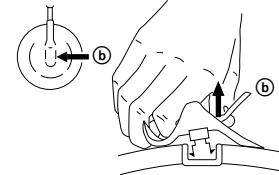

② Using a thumb pull up the rubber cap firmly in the direction indicated by the arrow ②.

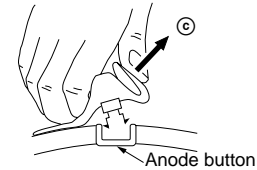

③ When one side of the rubber cap is separated from the anode button, the anode-cap can be removed by turning up the rubber cap and pulling it up in the direction of the arrow ③.

• HOW TO HANDLE AN ANODE-CAP

- ① Do not damage the surface of anode-caps with sharp shaped objects.
- ② Do not press the rubber too hard so as not to damage the inside of anode-cap. A metal fitting called the shatter-hook terminal is built into the rubber.
- ③ Do not turn the foot of rubber over too hard. The shatter-hook terminal will stick out or damage the rubber.

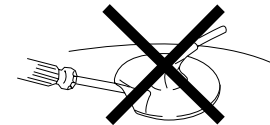
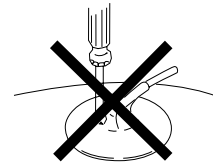

SECTION 3 SET-UP ADJUSTMENTS

- The following adjustments should be made when a complete realignment is required or a new picture tube is installed.
- These adjustments should be performed with rated power supply voltage unless otherwise noted.

Controls and switches should be set as follows unless otherwise noted:

PICTURE control normal
BRIGHTNESS control normal

Perform the adjustments in the following order :

1. Beam Landing
2. Convergence
3. Focus
4. White Balance

Note : Test Equipment Required.

1. Color-bar/Pattern Generator
2. Degausser
3. Oscilloscope

Preparation :

- In order to reduce the influence of geomagnetism on the set's picture tube, face it east or west.
- Switch on the set's power and degauss with the degausser.

3-1. BEAM LANDING

1. Input a white signal with the pattern generator.

Contrast	} normal
Brightness	
2. Position neck assy as shown in Fig3-1.
3. Set the pattern generator raster signal to a green raster.
4. Move the deflection yoke to the rear and adjust with the purity control so that the green is at the center and the blue and the red take up equally sized areas on each side.
(See Figures 3-1 through 3-3.)
5. Move the deflection yoke forward and adjust so that the entire screen is green. (See Figure 3-2.)
6. Switch the raster signal to blue, then to green and verify the condition.
7. When the position of the deflection yoke has been decided, fasten the deflection yoke with the screws and DY spacers.
8. If the beam does not land correctly in all the corners, use a magnet to adjust it.
(See Figure 3-4.)

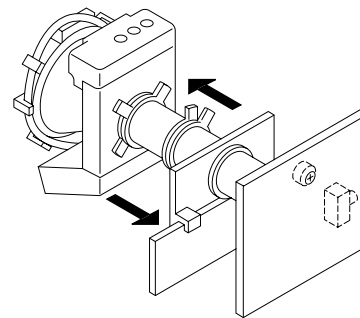

Fig. 3-2

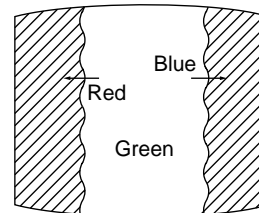

Fig. 3-3

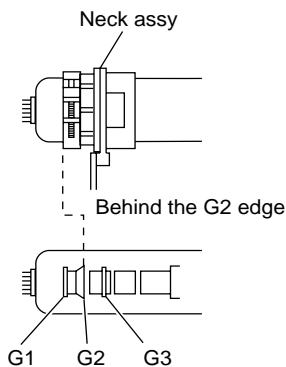

Fig. 3-1

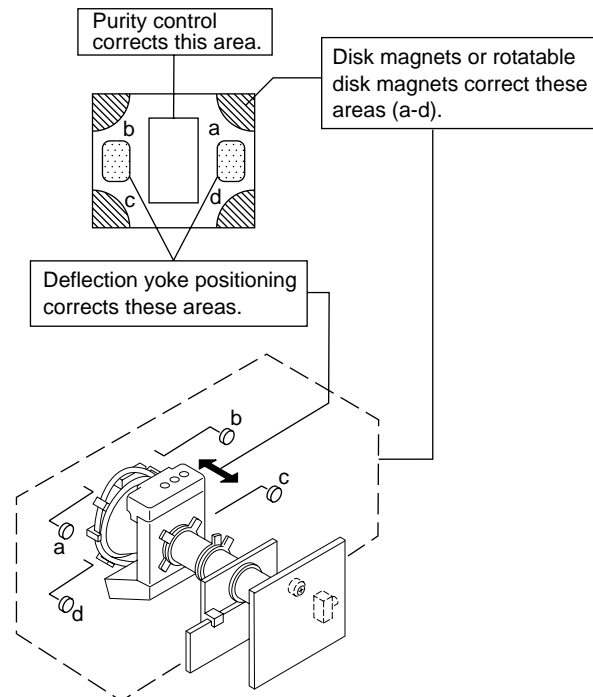

Fig. 3-4

3-2. CONVERGENCE ADJUSTMENT

Preparation :

- Before starting this adjustment, adjust the focus, horizontal size and vertical size.
- Set the PICTURE and BRIGHTNESS 50%.
- Cross hatch / Dot pattern.

(1) Horizontal and Vertical Static Convergence

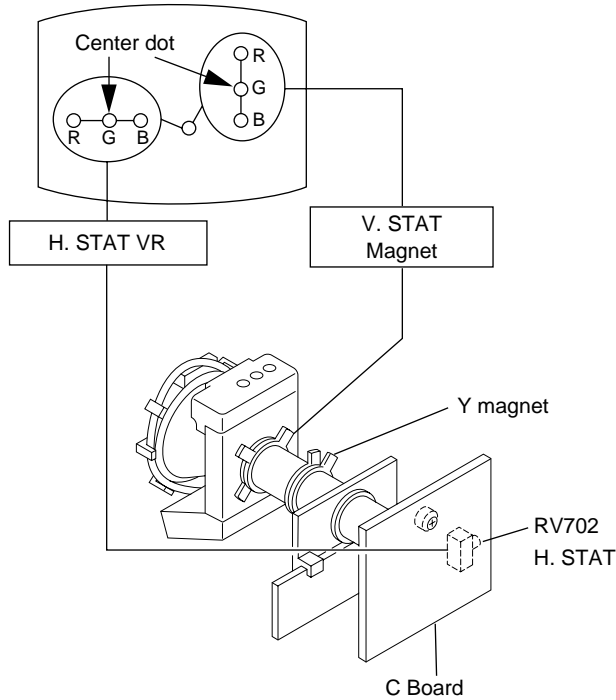

1. (Moving horizontally), adjust the H.STAT control so that the red, green and blue dots are on top of each other at the center of the screen.
2. (Moving vertically), adjust the V.STAT magnet so that the red, green and blue dots are on top of each other at the center of the screen.
3. If the H.STAT variable resistor cannot bring the red, green and blue dots together at the center of the screen, adjust the horizontal convergence with the H.STAT variable resistor and the V.STAT magnet in the manner given below.
(In this case, the H.STAT variable resistor and the V.STAT magnet influence each other, so be sure to perform adjustments while tracking.)

① V. STAT

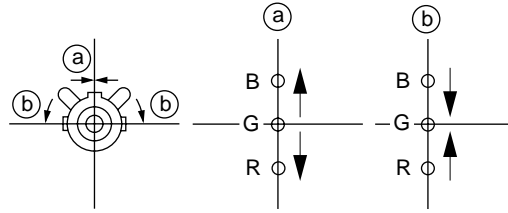

② H. STAT VR

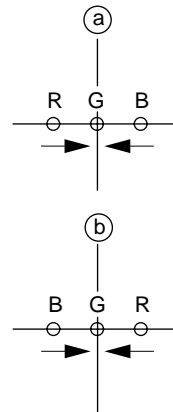

③

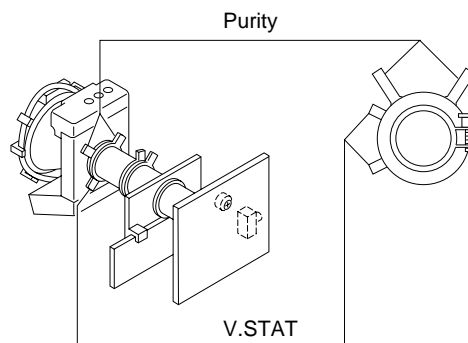
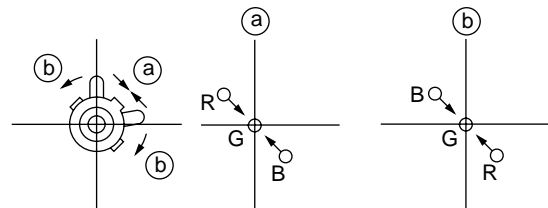

④ BMC (Hexapole) Magnet.

If the red, green and blue dots are not balanced or aligned, then use the BMC magnet to adjust in the manner described below.

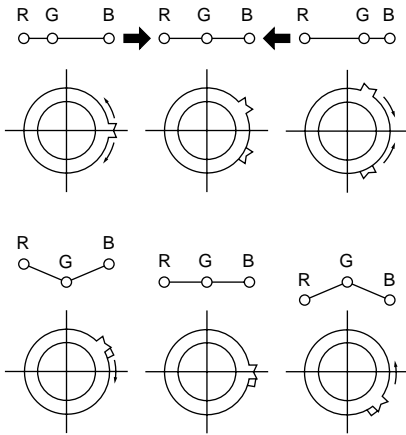

⑤ Y separation axis correction magnet adjustment.

1. Receive the cross-hatch signal and adjust [PICTURE] to [MIN] and [BRIGHTNESS] to [STANDARD] .
2. Adjust the Y separation axis correction magnet on the neck assembly so that the horizontal lines at the top and bottom of the screen are straight.

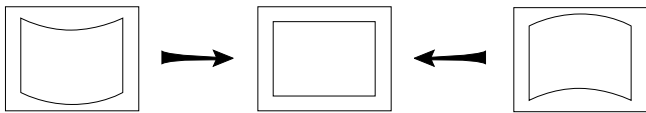
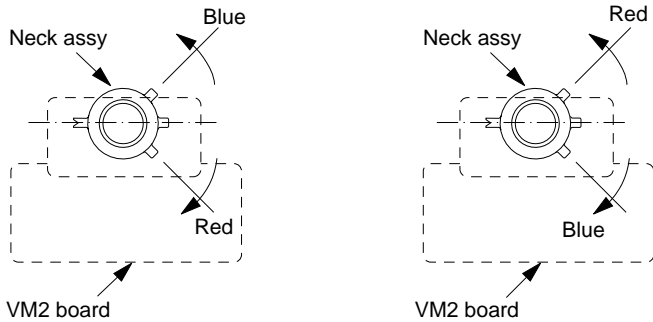

Note

1. The Red and Blue magnets should be equally far from the horizontal center line.
2. Do not separate the Red and Blue magnets too far. (Less than 8 mm)

(2) Dynamic Convergence Adjustment

Preparation:

- Before starting this adjustment, adjust the horizontal static convergence and the vertical static convergence
- Set the PICTURE and BRIGHTNESS to normal.

1. Adjust TLH. (TLH correction piece)

- ① Receive the dot/hatch pattern signal and adjust picture quality by the menu.
- ② Correct horizontal mis-convergence of red and blue of both sides on the X axis.

When red is outside insert BMC magnet to right side (THL+) views from DY neck. And when blue is outside, insert it to left side (THL-) and take both sides.

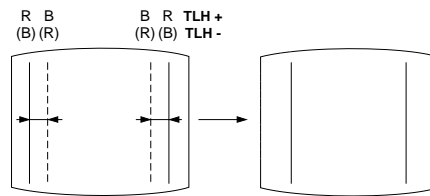

2. Adjust XCV core.

To able to become balance of XCV on the X axis well.

3. Adjust V-TILT.

Correct the vertical mis-convergence of red and blue of vertically sides on the Y axis.

4. Adjust YCH.

Adjust horizontal mis-convergence of red and blue of vertically sides on the Y axis. Mentioned above steps 2 to 4 are adjusting respectively perform minuteness tracking.

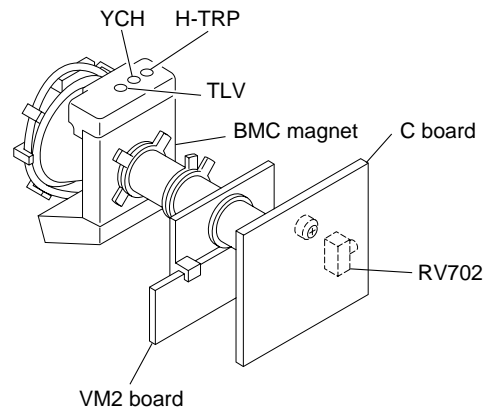

(3) Screen-corner Convergence

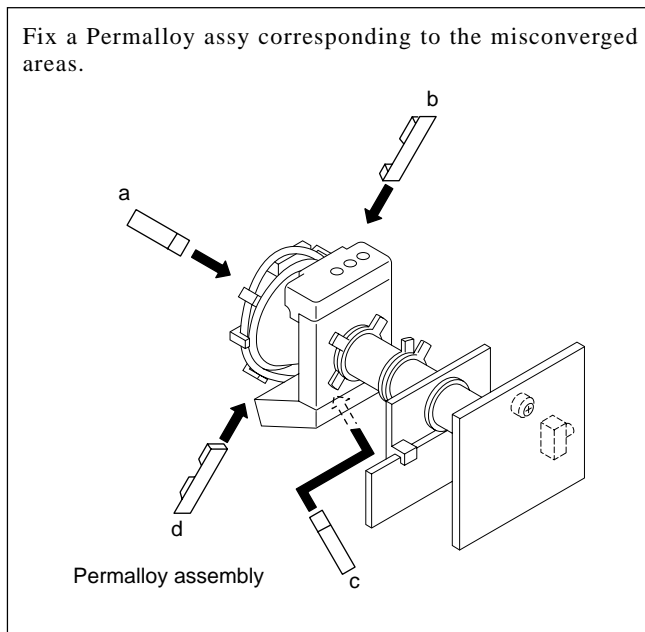
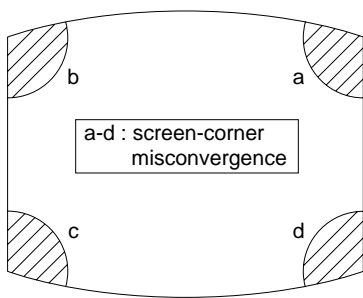

3-3. FOCUS ADJUSTMENT

Note

Focus adjustment should be completed before W/B adjustment.

- (1) Receive digital monoscope pattern.
- (2) Set "A/V CONTROL" to "STANDARD".
- (3) Adjust FOCUS VR so that the center of the screen becomes justfocus.
- (4) Change the receiving signal to white pattern and blue back.
- (5) Confirm MAGENTA RING should not be over the limit sample. In case MAGENTA RING is over the limit sample, adjust FOCUS VR to take tracking of MAGENTA RING and FOCUS.

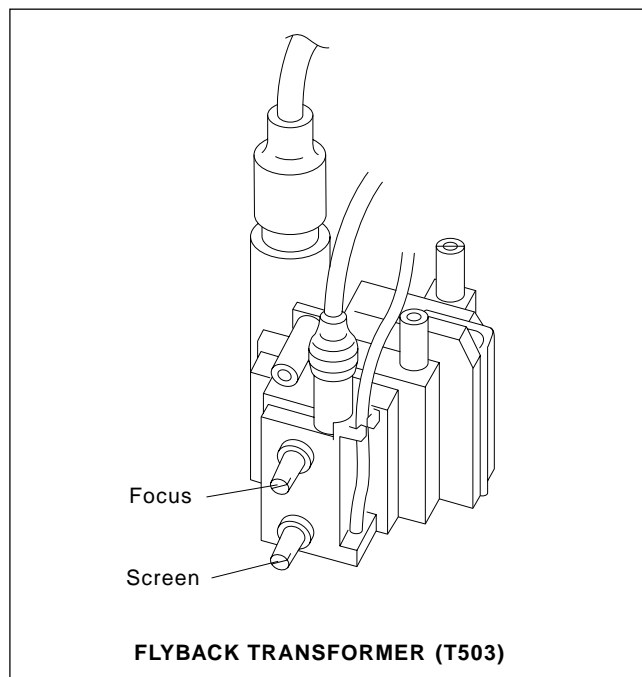

3-4. NECK ASSY TWIST ADJUSTMENT

- (1) Receive dot/hatch pattern.
- (2) Turn FOCUS VR fully counter-clockwise.
- (3) Confirm the dot shape at the screen center. (Fig. 3-4)
- (4) Resume FOCUS VR.

Note

In case of turning NECK ASSY, loosen the screw 3 turns. Do not move the position.

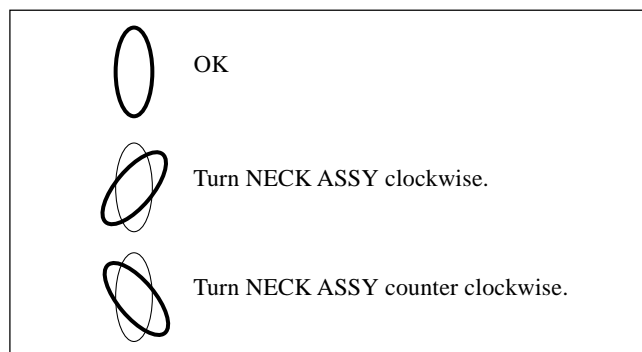
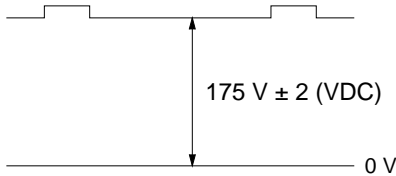

Fig. 3-4

3-5. G2 (SCREEN) AND WHITE BALANCE ADJUSTMENTS

1. G2 (SCREEN) ADJUSTMENT

- 1) Set the PICTURE and BRIGHTNESS to normal.
- 2) Put to VIDEO input mode without signals.
- 3) Connect R, G and B of the C board cathode to the oscilloscope.
- 4) Adjust G2 (Screen) volume to the value below.



2. DRIVE LEVEL ADJUSTMENT

- 1) Set to Service Mode (Refer Section 4-1: ADJUSTMENTS WITH COMMANDER).
- 2) Input PAL Colorbar Signal.
- 3) Set to VP7 (Service Mode) "DYC" = 0.
- 4) Set VP22 GON to "0", VP23 BON to "0".
- 5) Set to A/V mode to "PERSONAL".
- 6) Connect an oscilloscope to pin ② of CN705 on the C board.
- 7) Set the picture to maximum and Brightness to minimum.
Enter into the Service Mode.
- 8) Using the [1] and [4] buttons select SAJ0 "PMX".
- 9) Using the [3] and [6] buttons on the Remote Commander adjust until the oscilloscope waveform has an amplitude of $1.64 \pm 0.05V_{p-p}$.

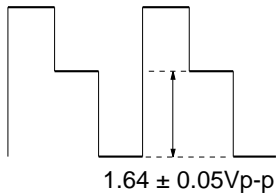

- 10) Reset to VP7 "DYC" = 1 and VP22 "GON" to 1, VP23 BON to "1".

3. WHITE BALANCE ADJUSTMENT

- 1) Set to Service Mode (Refer Section 4-1: ADJUSTMENTS WITH COMMANDER).
- 2) Input white raster signal.
- 3) Set the following condition.
PICTURE minimum, BRIGHTNESS 50%
- 4) Select GCT (WHB 4) and BCT (WHB 5) with [1] and [4], and adjust the level with [3] and [6] for the best white balance.
- 5) Set the PICTURE to maximum.
- 6) Select GDR (WHB 1) and BDR (WHB 2) with [1] and [4], and adjust the level with [3] and [6] for the best white balance.
- 7) Write into the memory by pressing [MUTING] then [0].

4. SUB PICTURE BRIGHTNESS ADJUSTMENT

- 1) Set to service mode (Refer Section 4-1: ADJUSTMENTS WITH COMMANDER).
- 2) Input a PAL RF colorbar signal through Sub TUNER (TU3301).
- 3) BRIGHTNESS RESET.
PICTURE MINIMUM
- 4) A: Select SBR (WHB7) with [1] and [4], and adjust SBR (WHB7) level with [3] and [6] so that the second stripe from the right is dimly lit.
B: Adjust RV5301 on B board so that the level of CN1310 ⑩ pin is within spec.

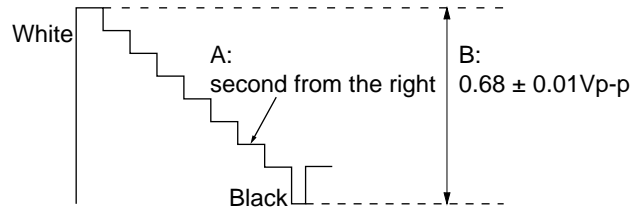

3-6. FREQUENCY (FREE RUN) ADJUSTMENT

- 1) Select Video 1 (no signal).
- 2) Connect a frequency counter across pin ⑩ (FH) IC301 of A Board.
- 3) Select VP (OF) HOS with [1] and [4] of the commander then adjust to $15.690kHz \pm 25Hz$ using [3] and [6].

SECTION 4 CIRCUIT ADJUSTMENTS

4-1. ADJUSTMENTS WITH COMMANDER

Service adjustments are made with the RM-951 that comes with this unit.

a. ENTERING SERVICE MODE

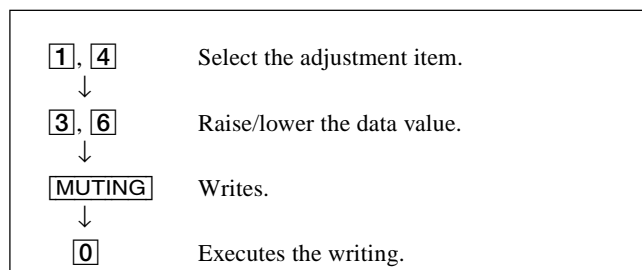
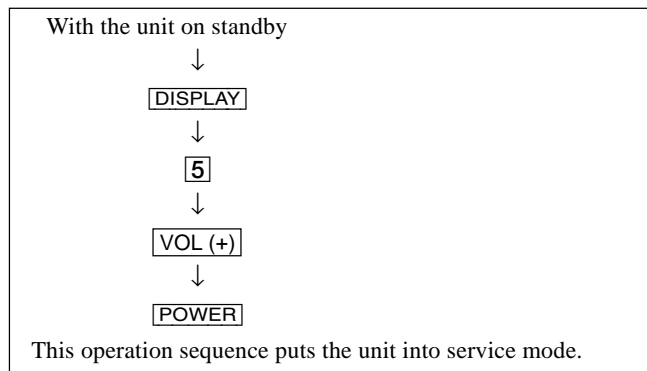

- [7], [0] All the data becomes the values in memory.
- [8], [0] All user control goes to the standard state.
- [5], [0] Service data initialization (Be sure not to use usually.)
- [2], [0] Write 50Hz adjustment data to 60Hz, or vice versa.

b. METHOD OF CANCELLATION FROM SERVICE MODE

Set the standby condition (Press [POWER] button on the commander), then press [POWER] button again, hereupon it becomes TV mode.

c. METHOD OF WRITE INTO MEMORY

- 1) Set to Service Mode.
- 2) Press [1] (UP) and [4] (DOWN), select an item of adjustment.
- 3) Press [MUTING] button and it will indicate WRITE on the screen.
- 4) Press [0] button to write into memory.

d. MEMORY WRITE CONFIRMATION METHOD

- 1) After adjustment, pull out the plug from AC outlet, and then plug into AC outlet again.
- 2) Turn the power switch ON and set to Service Mode.
- 3) Call the adjusted items again to confirm adjustments were made.

The screen display is :

Device Name	Item Name	Item No	Data	Marking of virgin NVM	Mode	
GEO	HPS	00	1C	■	SERVICE	50 ← PAL, SECAM : 50
006S	59	1.0C	7F	0	000A	NTSC : 60
Suffix No (OEM Code)		Software version		Total Power-On time (hours)		

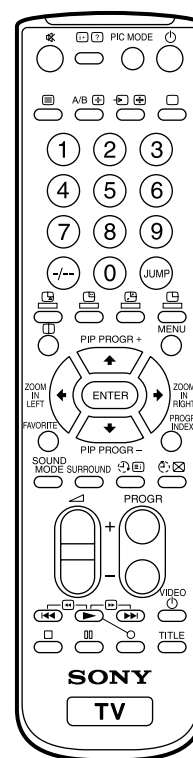

RM-951

4-2. ADJUSTMENT METHOD

Item Number 00 of device GEO

This explanation uses H-Position as an example.

1. Select "GEO 00 HPS" with the **[1]** and **[4]** buttons.
2. Raise/lower the data with the **[3]** and **[6]** buttons.
3. Select the optimum state. (The standard is 1F for PAL reception.)
4. Write with the **[MUTING]** button. (The display changes to WRITE.)
5. Execute the writing with the **[0]** button. (The WRITE display will be changed to red color while excuting, and back to SERVICE.)

Use the same method for all Items. Use **[1]** and **[4]** to select the adjustment item, use **[3]** and **[6]** to adjust, write with **[MUTING]**, then execute the write with **[0]**.

- Note :**
1. In **[WRITE]**, the data for all items are written into memory together.
 2. For adjustment items that have different standard data between 50Hz or 60Hz, be sure to use the respective input signal after adjustment.

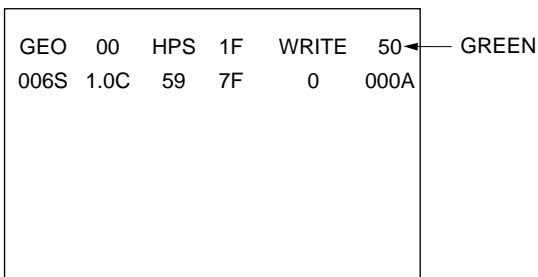
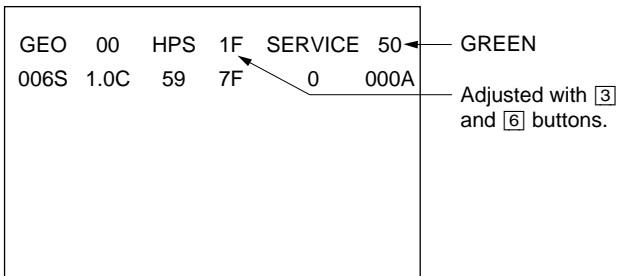

Written with **[MUTING]**

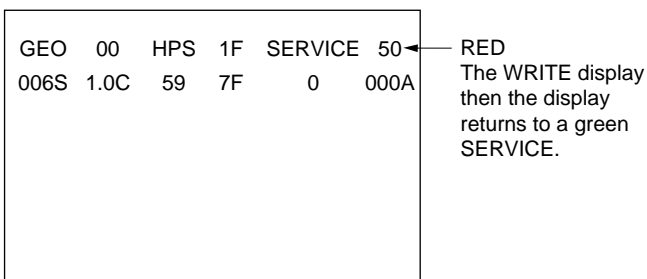

Write executed with **[0]**

Adjustment Item Table

Device Name	Functionality		Note	Data Range	Function	Note for Different Data	Register No. (bit)	Slave Address	RAM Address (bit)
	No	Name							
GEO	0	HPS	13	3F	H Position	50/60/MID50/MID60	12 (7-2)	CXA2130S(88H)	96 (7-2)
	1	HSZ	26	3F	H Size	50/60/MID50/MID60	11 (7-2)		95 (7-2)
	2	PAP	22	3F	Pin Amp	50/60HZ	13 (7-2)		97 (7-2)
	3	TLT	6	0F	Trapezium	50/60/MID50/MID60	15 (7-4)		99 (7-4)
	4	VPS	25	3F	V Position	50/60/MID50/MID60	0F (7-2)		93 (7-2)
	5	VSZ	16	3F	V Size	50/60/MID50/MID60	0E (7-2)		92 (7-2)
	6	SCO	8	0F	S Correction	50/60HZ	10 (7-4)		94 (7-4)
	7	VLN	7	0F	V Linearity	50/60HZ	10 (3-0)		94 (3-0)
	8	BOW	8	0F	AFC Bow	50/60HZ	16 (7-4)		9A (7-4)
	9	AGL	8	0F	AFC Angle	50/60HZ	16 (3-0)		9A (3-0)
	0A	UPN	25	3F	Upper Pin	50/60HZ	14 (7-2)		98 (7-2)
	0B	LPN	25	3F	Lower Pin	50/60HZ	18 (7-2)		9C (7-2)
	0C	HBL	0	1	H Blanking on/off		18 (1)		6C (1)
	0D	LBL	7	0F	Left H Blanking	50/60HZ	17 (7-4)		9B (7-4)
0E	RBL	7	0F	Right H Blanking	50/60HZ	17 (3-0)	9B (3-0)		
WHB	0	RDR	25	3F	R Drive	DYNAMIC/other	09 (7-2)	CXA2130S(88H)	A3 (7-2)
	1	GDR	25	3F	G Drive	DYNAMIC/other	0A (7-2)		A4 (7-2)
	2	BDR	25	3F	B Drive	DYNAMIC/other	0B (7-2)		A5 (7-2)
	3	RCT	7	0F	R Cutoff	SECAM/other	07 (3-0)		A7 (3-0)
	4	GCT	7	0F	G Cutoff	SECAM/other	08 (7-4)		A8 (3-0)
	5	BCT	7	0F	B Cutoff	SECAM/other	08 (3-0)		A8 (3-0)
	6	BMN	18	1F	Brightness Minimum Data		06 (7-2)		106
7	SBR	2E	3F	Sub Brightness Control		06 (7-2)	107		
SAJ	0	PMX	2B	3F	Picture Maximum Data		03 (7-2)	CXA2130S(88H)	105
	1	SHU	0	0F	Sub Hue Control	TV/Video	05 (7-2)		108
	2	SSH	4	0F	Sub Sharpness Control	TV/Video	07 (7-4)		109
	3	SCL	20	3F	Sub Color Control	NTSC/others	04 (7-2)		10A
VP	0	EHT	5	0F	EHT Comp	50/60HZ	15 (3-0)	CXA2130S(88H)	99 (3-0)
	1	GMA	2	03	Gamma Correction	NTSC/others	0B (1-0)		25B (1-0)
	2	YDL	00	0F	Y Delay	PAL/SECAM/NTSC/DVD	0C (3-0)		A0 (3-0)
	3	SST	2	03	SECAM ID Start Position		1B (1-0)		6F (1-0)
	4	SSP	1	03	SECAM ID Stop Position		1B (3-2)		6F (3-2)
	5	SLV	1	03	SECAM ID Level		1C (1-0)		70 (1-0)
	6	SBF	22	3F	SECAM BELL f0		1C (7-2)		70 (7-2)
	7	DYC	1	1	Dynamic Color on/off		0A (1)		5E (1)
	8	ABL	0	1	ABL Mode Switching (except STANDARD mode)		09 (1)		5D (1)
	9	VTH	1	1	ABL Detection Vth Switching		09 (0)		5D (0)
	0A	SFO	1	1	FO Switching for Sharpness	NTSC/others	05 (1)		24A (1)
	0B	DCX	1	1	DC Trans. Ratio Switching		06 (1)		5A (1)
	0C	SHT	1	1	Pre-/Overshoot ratio Switch	NTSC/others	06 (0)		24A (0)

Adjustment Item Table

Device Name	Functionality		Note	Data Range	Function	Note for Different Data	Register No. (bit)	Slave Address	RAM Address (bit)
	No	Name							
VP	0D	HDW	0	1	H Drive Pulse Width Switch	TV/Video/Text	00 (6)	CXA2130S(88H)	54 (6)
	0E	AFC	0	03	AFC Gain Control		0F (1-0)		A1 (1-0)
	0F	HOS	7	0F	H Oscillation		0C (7-4)		60 (7-4)
	10	HSS	0	1	Slice Level of H Sync Sep.		0D (1)		61 (1)
	11	VSS	0	1	Slice Level of V Sync Sep.	0D (0)	61 (0)		
	12	HMS	1	1	Macro Vision C/m off/on	50/60Hz	0E (0)		92 (0)
	13	YUV	0	1	YUV Switch Control	01 (0)	55 (0)		
	14	CDV	1	3	CD mode for Video	Video only	0D (5-4)		259 (5-4)
	15	RON	1	1	R ON	not memorized	01 (3)		55 (3)
	16	GON	1	1	G ON	not memorized	01 (2)		55 (2)
	17	BON	1	1	B ON	not memorized	01 (1)		55 (1)
	18	PON	1	1	P ON	not memorized	00 (7)		54 (7)
	19	BLK	0	1	BLK Off		12 (0)		66 (0)
	1A	VMC	1	1	VM Off		13 (0)		67 (0)
AP	0	BCS	1	3	Bass Center Shift		#4 (3-0)	TDA7315(80H)	24C (1-0)
	1	TCS	1	3	Treble Center Shift		#5 (3-0)		24D (1-0)
MSP	0	WST	15	FF	W/G Stereo Threshold			MSP3415D(84H)	165
	1	WBT	EA	FF	W/G Bilingual Threshold				166
	2	WLL	5	FF	W/G Monaural Threshold				167
	3	WAC	1	0F	W/G Agreement Count				168
	4	WDL	30	FF	W/G Search Delay				169
	5	NDL	20	FF	NICAM Search Delay				16A
	6	SDL	10	FF	Stereo status Read Delay				16B
	7	AGC	1	1	AGC Switch Auto/Constant		00BB (7)		116 (7)
	8	REL	28	3F	AGC Gain at Constant Mode		00BB (6-1)		116 (6-1)
	9	CRM	0	1	Carrier muting on/off		00BB (9)		115 (9)
	0A	ACO	1	1	Audio Clock out on/off		0083 (5)		11A (5)
	0B	FP	1B	7F	FM Prescale for non-M system		000E (14-8)		221
	0C	FPM	32	7F	FM Prescale for M system		000E (14-8)		222
	0D	FH	2D	7F	FM Prescale for HDEV		000E (14-8)		223
0E	FHM	65	7F	FM Prescale for HDEV and M		000E (14-8)	224		
0F	WGP	2A	7F	W/G Prescale		000E (14-8)	225		
10	NIP	6D	7F	NICAM Prescale		0010 (14-8)	14F		
11	ERR	50	FF	Auto FM switch Threshold		0021 (10-3)	174		
12	VOL	FF	FF	Loud Speaker gain 0700 to 07FFh		0000 (11-4)	254		

Adjustment Item Table

Device Name	Functionality		Note	Data Range	Function	Note for Different Data	Register No. (bit)	Slave Address	RAM Address (bit)
	No	Name							
LTI	0	LDH	1	1	Histogram Segment Selection			TDA9178 (40H)	
	1	CFS	1	1	Contour Filter Selection				
	2	WLB	0	1	Letterbox Window Switch				
	3	VDC	1	1	Video Dependent Coring				
	4	DEM	0	1	Demonstration Mode				
	5	CDP	0	07	Luminance Delay				
	6	OSP	1	1	Overrule Smart Peaking				
	7	WPO	0	1	White Point Stretch Off				
	8	DSK	0	1	Skin Tone Switch				
	9	ASK	0	1	Skin Tone Angle Selection				
	0A	WSK	0	1	Skin Tone Width Selection				
	0B	SSK	0	1	Skin Tone Size Selection				
	0C	DGR	1	1	Green Enhancement Switch				
	0D	DGT	7	7	Threshold of Green Enhancement Switch				
	0E	GGR	0	1	Green Enhancement Gain				
	0F	WGR	0	1	Green Enhancement Width				
	10	SGR	0	1	Green Enhancement Size				
	11	DBL	0	1	Blue Stretch Switch				
	12	GBL	0	1	Blue Stretch Gain Selection				
	13	SBL	0	1	Blue Stretch Size Selection				
	14	CDS	1	1	Color Dependent Sharpness				
	15	CST	7	7	Threshold of Color Dependent Sharpness				
	16	CTI	0	1	Color Transient Improvement				
	17	BON	0	1	Black offset Compensation				
	18	BTD	0	3F	Adaptive Black Stretch				
19	NLD	15	3F	Non-Linearity Amplifier					
1A	NLW	4	7	Step Width of Non-Linearity Amplifier					
1B	VGD	20	3F	Variable Gamma					
1C	VGW	0	7	Step Width of Variable Gamma					
1D	PKD	1A	3F	Peaking Amplitude					
1E	PKW	8	0F	Step Width of Peaking Amplitude					
1F	SPD	1F	3F	Steepness Correction					
20	CRD	13	3F	Coring Level					
21	CRW	9	0F	Step Width of Coring Level					
22	LWD	1F	3F	Line Width Correction					
23	SNM	1	7	S/N Mode under unreliable S/N Condition					
24	SNC	3	0F	S/N Ratio Average Counter	TV/Video				
25	FMC	2	0F	Feature Mode Matching Counter					

Adjustment Item Table

Device Name	Functionality		Note	Data Range	Function	Note for Different Data	Register No. (bit)	Slave Address	RAM Address (bit)
	No	Name							
MID	0	HAT	1C	FF	H Phase for A-ch in Twin mode			CXP86332 (6EH)	
	1	HAX	21	FF	H Phase for A-ch in Index mode				
	2	VPA	0C	FF	V Phase for A-ch (common)				
	3	DLA	3	07	Chroma Delay for A-ch				
	4	VJA	0	03	V-Jitter Reduction for A-ch				
	5	CYA	10	FF	Y-Clamp Level for A-ch				
	6	CUA	80	FF	U-Clamp Level for A-ch				
	7	CVA	80	FF	V-Clamp Level for A-ch				
	8	DPA	0	7F	Clamp Delay Position for A-ch				
	9	HBT	22	FF	H Phase for B-ch in Twin mode				
	0A	HBI	20	FF	H Phase for B-ch in PinP mode				
	0B	HBX	21	FF	H Phase for B-ch in Index mode				
	0C	VPB	0C	FF	V Phase for B-ch except in Index				
	0D	VBX	9	FF	V Phase for B-ch in Index mode				
	0E	DLB	3	07	Chroma Delay for B-ch				
	0F	VJB	0	03	V-Jitter Reduction for B-ch				
	10	CYB	10	FF	Y-Clamp Level for B-ch				
	11	CUB	80	FF	U-Clamp Level for B-ch				
	12	CVB	80	FF	V-Clamp Level for B-ch				
	13	DPB	0	7F	Clamp Delay Position for B-ch				
	14	VJC	3	3	V-Jitter Reduction for C-ch				
	15	DLC	4	7	Chroma Delay for C-ch				
	16	YSD	1	7	YS Delay				
	17	ADA	0	1	AD Switch for A-ch				
	18	ADB	0	1	AD Switch for B-ch				
	19	DCA	0	3	Digital Input Color Signal Phase for A-ch				
	1A	DCB	0	3	Digital Input Color Signal Phase for B-ch				
	1B	ACA	0	1	ADC on/off for A-ch				
1C	ACB	0	1	ADC on/off for B-ch					
1D	WIA	0	3	Write Interlace Correction for A-ch					
1E	RIA	0	3	Read Interlace Correction for A-ch					
1F	WIB	0	3	Write Interlace Correction for B-ch					
20	RIB	0	3	Read Interlace Correction for B-ch					
21	OEA	0	1	Odd/Even Selection for A-ch					
22	EIA	0	3	Reverse Interlace Correction for A-ch					
23	OEB	0	1	Odd/Even Selection for B-ch					
24	EIB	0	3	Reverse Interlace Correction for B-ch					
25	OEC	0	1	Odd/Even Selection for C-ch					
26	OES	0	1	Option 1 for Euro model					
27	OID	1	1	Option 2 for Field ID					
28	OVF	0	1	Option 3 for V LPF					

Adjustment Item Table

Device Name	Functionality		Note	Data Range	Function	Note for Different Data	Register No. (bit)	Slave Address	RAM Address (bit)
	No	Name							
MID	29	OSH	1A	3F	OSD H Position			CXP86332 (6EH)	
	2A	OSV	2C	3F	OSD V Position				
	2B	PHP	3	0F	PinP H Position				
	2C	PVP	4	0F	PinP V Position				
SVP	0	SBF	22	3F	SECAM BELL f0		1C (7-2)	CXA2060AS(8AH)	85 (7-2)
	1	HOS	7	0F	H Oscillation		0C (7-4)		80 (7-4)
	2	SHU	6	0F	Sub Hue Control		05 (7-2)		210
	3	SCL	1F	3F	Sub Color Control		04 (7-2)		211
DSP	0	TS1	A5	FF	TruSurround Effect 1	Virtual/TruSurr.		TC9447F(32H)	
	1	TS2	5A	FF	TruSurround Effect 2	Virtual/TruSurr.			
	2	SR1	FF	FF	SRS Effect 1	TruSurr./Simulate			
	3	SR2	FF	FF	SRS Effect 2	TruSurr./Simulate			
	4	BH1	40	FF	BBE Effect 1 for BBE High	Off/Vir./Tru./Sim.			
	5	BH2	48	FF	BBE Effect 2 for BBE High	Off/Vir./Tru./Sim.			
	6	BL1	33	FF	BBE Effect 1 for BBE Low	Off/Vir./Tru./Sim.			
7	BL2	33	FF	BBE Effect 2 for BBE Low	Off/Vir./Tru./Sim.				
OPM	0	OSH	0C	3F	OSD H Position	Option-Misc	1F1	CXP750097(60H)	18D (7-2)
	1	COM	2	03	Comb Selection				23F (7-6)
	2	APC	0	1	APC Switch				23E (5)
	3	TSY	0	03	TV Sys at Auto TV Sys				23E (4-3)
	4	MUT	0	1	No Signal Mute				23E (0)
	5	AFM	1	1	Auto FM switch				23E (1)
	6	RFB	0	03	C-BPF Control				23F (5-4)
	7	TVO	3	7	Tilt to V-Angle offset				23F (2-0)
8	DBL	0	1	Disable Blueback Function	23F (2-0)				
OPB	0	OP1	FF	FF	Optional Bits 1 (see below)	Option-Bits		CXP750097(60H)	48
	1	OP2	E7	FF	Optional Bits 2 (see below)		49		
	2	OP3	32	FF	Optional Bits 3 (see below)		4A		

NOTE

- ■ shaded items are fixed data.
- Standard data listed on the Adjustment Item Table are reference values, therefore it may be different for each model and for each mode.
- Note for Different Data: Those are the standard data values written on the microprocessor. Therefore, the data values of the modes and stored respectively in the memory.
In case of a device replacement, adjustment by rewriting the data value is necessary for some items.

ITEM INFORMATION.**No. OPB0 OP1**

Item	XTAL 4.43	XTAL 3.58	SECAM	2nd. Lang	B/G	I	D/K	M
KV-EF34M80	1	1	1	1	1	1	1	1

No. OPB1 OP2

Item	TOP	NICAM	HDEV	Thai Bil	–	DVD Input	AV Input	
KV-EF34M80	0	1	1	0	0	1	1	1

No. OPB2 OP3

Item	–	–	Auto PIC	Auto TV sys	US ST	Arabic	11 KEY	Chinese
KV-EF34M80	0	0	1	1	0	0	1	0

4-3. PICTURE QUALITY ADJUSTMENTS

SUB COLOR ADJUSTMENT (SCL)

1. Set to service mode.
2. Input RF PAL colorbar signal.
Set A/V control to PERSONAL.
3. Set to VP7 (Service mode) "DYC" = 0
4. Set the following condition.
Picture to 100%, Color to 0% and Bright to 0%.
5. Connect an oscilloscope to the pin ③ (BLUE) of CN705, C board.
6. Using the **[1]** and **[4]** buttons select SAJ 3 (Service mode) "SCL".
7. Using the **[3]** and **[6]** buttons on the Remote Commander to adjust to VB2 = VB3 = VB4 with **[3]** and **[6]**.
8. Write into the memory by pressing "MUTING" then "0".
9. Input NTSC colorbar signal to VIDEO1 and select VIDEO1 input.
10. Adjust as step 4. and 8. by receiving NTSC colorbar.
11. Reset to VP 7 (Service mode) "DYC" = 1.

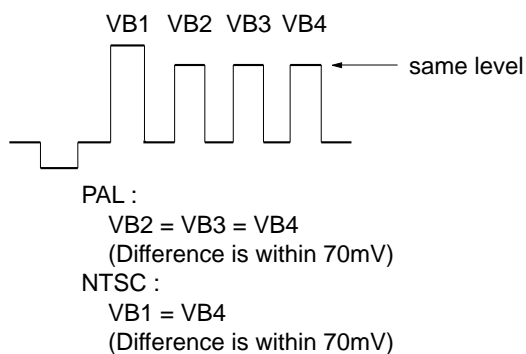

SUB HUE ADJUSTMENT (SHU)

12. Set to service mode.
13. Input NTSC colorbar signal to VIDEO1 and select VIDEO1 input.
14. Set to VP 7 (Service mode) "DYC" = 0
15. Connect an oscilloscope to the pin ③ (BLUE) of CN705, C board.
16. Using the **[1]** and **[4]** buttons select SAJ 1 (Service mode) "SHU (VIDEO)".
17. Using the **[3]** and **[6]** buttons on the Remote Commander to adjust to VB2 = VB3 = VB4 with **[3]** and **[6]**.
18. Write into the memory by pressing **[MUTING]** then **[0]**.
19. Reset to VP 7 (Service mode) "DYC" = 1.

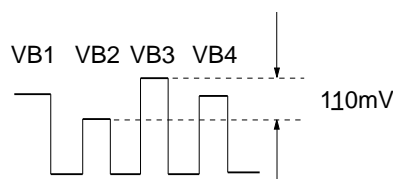

The highest level of VB1,VB2,VB4 will be aligned at the same line.
The ideal different level between VB2 and VB3 is within $\pm 110\text{mV}$.

20. Select "TWIN PICTURE" mode. (MID)
21. Receive different RF PAL white signals in MAIN and SUB picture.
22. Adjust RV5301 on B board so that the level at pin ② (BLUE) of CN705 on C board becomes within spec.

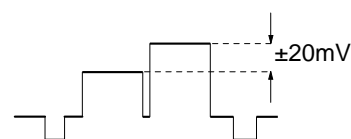

23. Receive RF NTSC colorbar signal in MAIN picture and VIDEO1 NTSC colorbar signal in SUB picture.
24. Adjust SVP2 (Service mode) "SHU (VIDEO)" so that the level at pin ③ (BLUE) of CN705 on C board becomes within spec.
25. Write into the memory by pressing **[MUTING]** then "0".

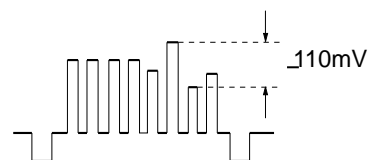

26. Write SJA 3 (Service mode) "SCL (PAL)" +4 steps to SJA 3 (Service mode) "SCL (PAL)".
Write SJA 3 (Service mode) "SCL (NTSC)" +3 steps to SJA 3 (Service mode) "SCL (NTSC)".
Write SJA 1 (Service mode) "SHU (VIDEO)" +3 steps to SJA 1 (Service mode) "SHU (VIDEO)".
Write SJA 1 (Service mode) "SHU (VIDEO)" -5 steps to SJA 1 (Service mode) "SHU (TV)".
Write SVP 2 (Service mode) "SHU (VIDEO)" +3 steps to SVP 2 (Service mode) "SHU (VIDEO)".
Write SVP2 (Service mode) "SHU (VIDEO)" -2 steps to SVP 2 (Service mode) "SHU (TV)".
27. Reset to VP 7 (Service mode) "DYC" = 1

Y LEVEL (SUB PICTURE) ADJUSTMENT

1. Input a PAL colorbar signal.
2. Set to TWIN PICTURE mode.
3. Connect an oscilloscope to pin ② (R-out) of CN705 on the C board.
4. Adjust VR5301 on B board so that white level of main picture and sub picture becomes same level.

HUE LEVEL (SUB PICTURE) ADJUSTMENT

1. Input a NTSC colorbar VIDEO signal.
2. Set to TWIN PICTURE mode.
3. Connect an oscilloscope to pin ② (R-out) of CN705 on the C board.
4. Select SVP (02) SHU with [1] and [4] of the commander so that waveform of main picture and sub picture become same level.
5. Press [MUTING] → [0] on the commander to write the data with SVP (02) "SHU" Video mode and TV mode.

H-TRAPIZIUM ADJUSTMENT

1. Input a cross hatch/dot signal.
2. Adjust RV1801 on C board to make H-Trapezoid distortion best.

4-4. A BOARD ADJUSTMENT AFTER IC003 (MEMORY) REPLACEMENT

When replacing IC003 (MEMORY), be sure to change IC001 (μ-COM) to the following new IC at the same time.

MODEL	IC001 (μ-COM)
KV-EF34M80	CXP750097-006S

1. Enter to Service Mode.
2. Press commander buttons [5] and [0] (Data Initialize), and [2] and [0] (Data Copy) to initialize the data.
3. Call each item number and check if the respective screen shows the normal picture.
In cases where items are not well adjusted, rectify the items with fine adjustment.
Write the data per each item number ([MUTING] + [0]).
4. Select item numbers "OPB0" (OP1), "OPB1" (OP2) and "OPB2" (OP3) and respectively set the bit per model with command buttons [3] and [6].
5. Press commander buttons [8] and [0] (Test Normal) to return to the data that was set on the shipment from the factory.
(This will also cancel Service Mode.)

4-5. PICTURE DISTORTION ADJUSTMENT (1)

Item Number 00 – 0B

GEO 0 HPS (H POSITION)

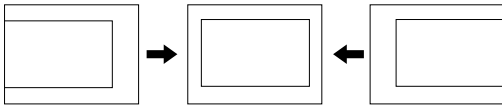

GEO 1 HSZ (H SIZE)

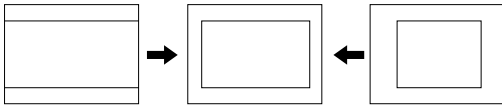

GEO 2 PAP (PIN AMP)

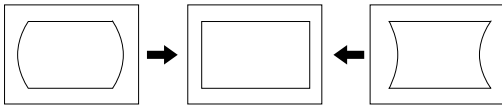

GEO 3 TLT (TRAPEZIUM)

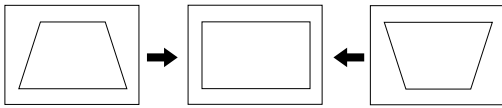

GEO 4 VPS (V POSITION)

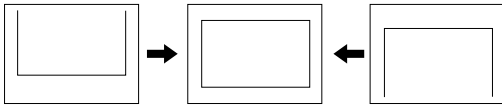

GEO 5 VSZ (V SIZE)

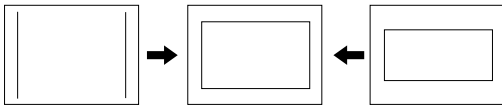

GEO 6 SCO (VERTICAL S-Correction)

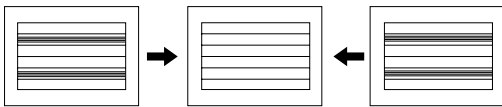

GEO 7 VLN (V LINEARITY)

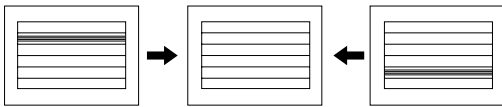

GEO 8 BOW (AFC.BOW)

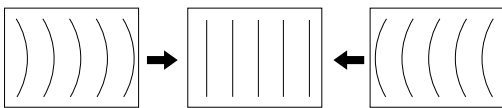

GEO 9 AGL (AFC.ANGLE)

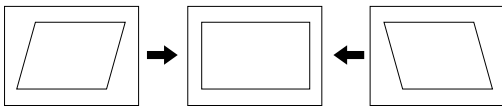

GEO 0A UCP (UPPER CORNER PIN)

GEO 0B LCP (LOWER CORNER PIN)

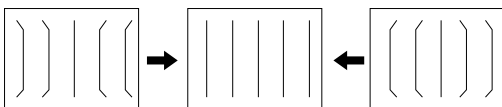

PICTURE DISTORTION ADJUSTMENT (2)

H-TRAPEZOID (Rotate RV1801)

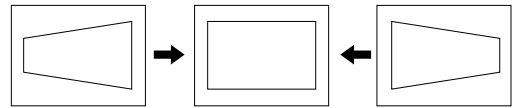

5-1. BLOCK DIAGRAM

SECTION 5
DIAGRAMS

KV-EF34M80 RM-951 KV-EF34M80 RM-951

KV-EF34M80 RM-951 KV-EF34M80 RM-951

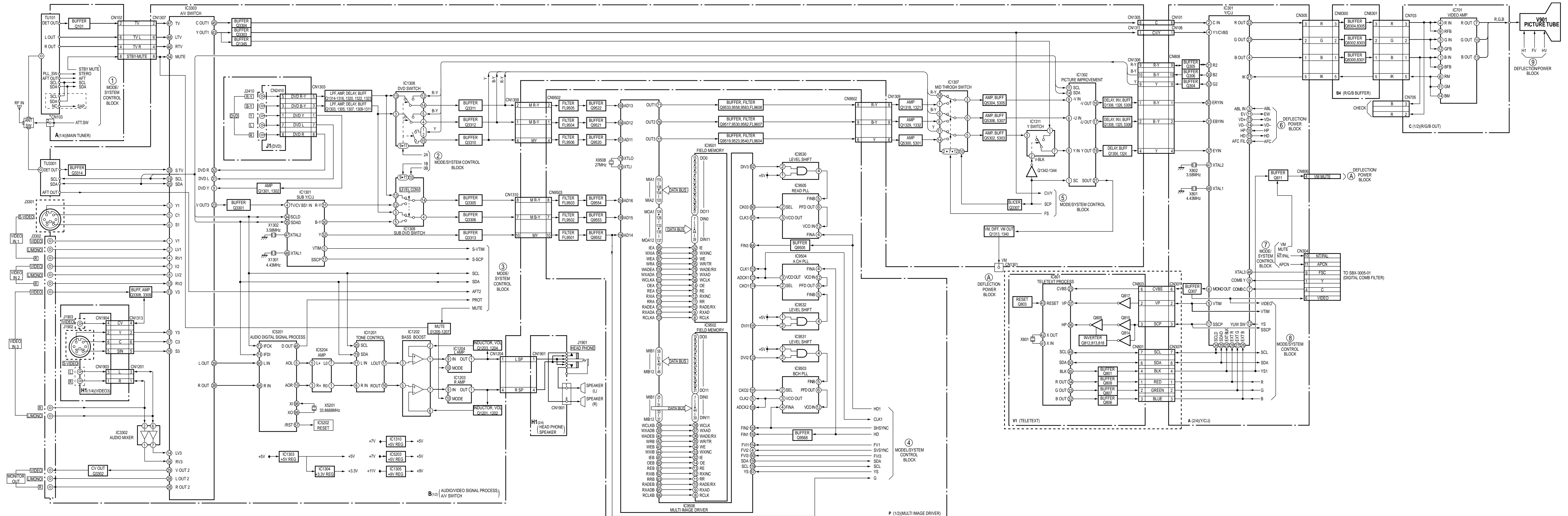

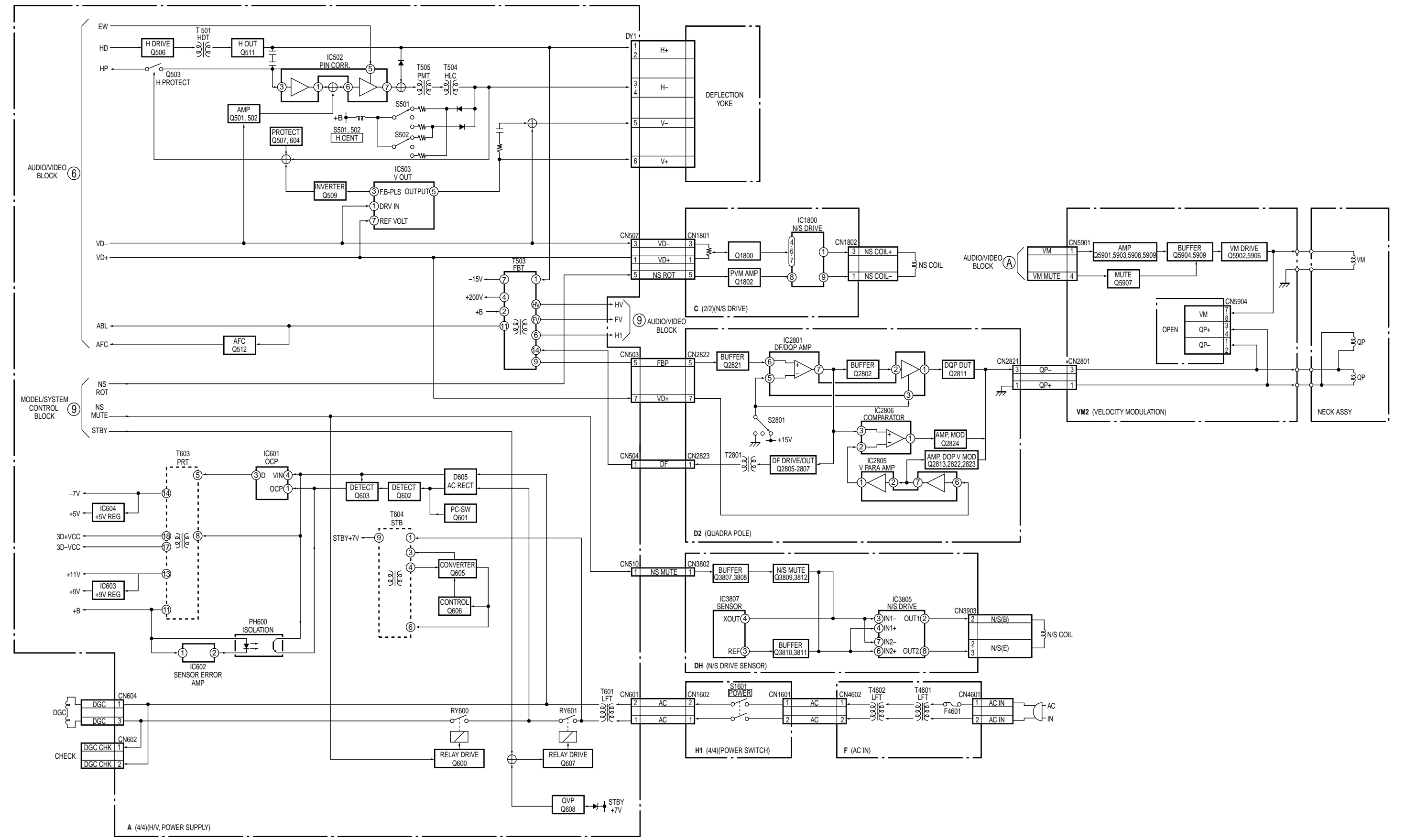
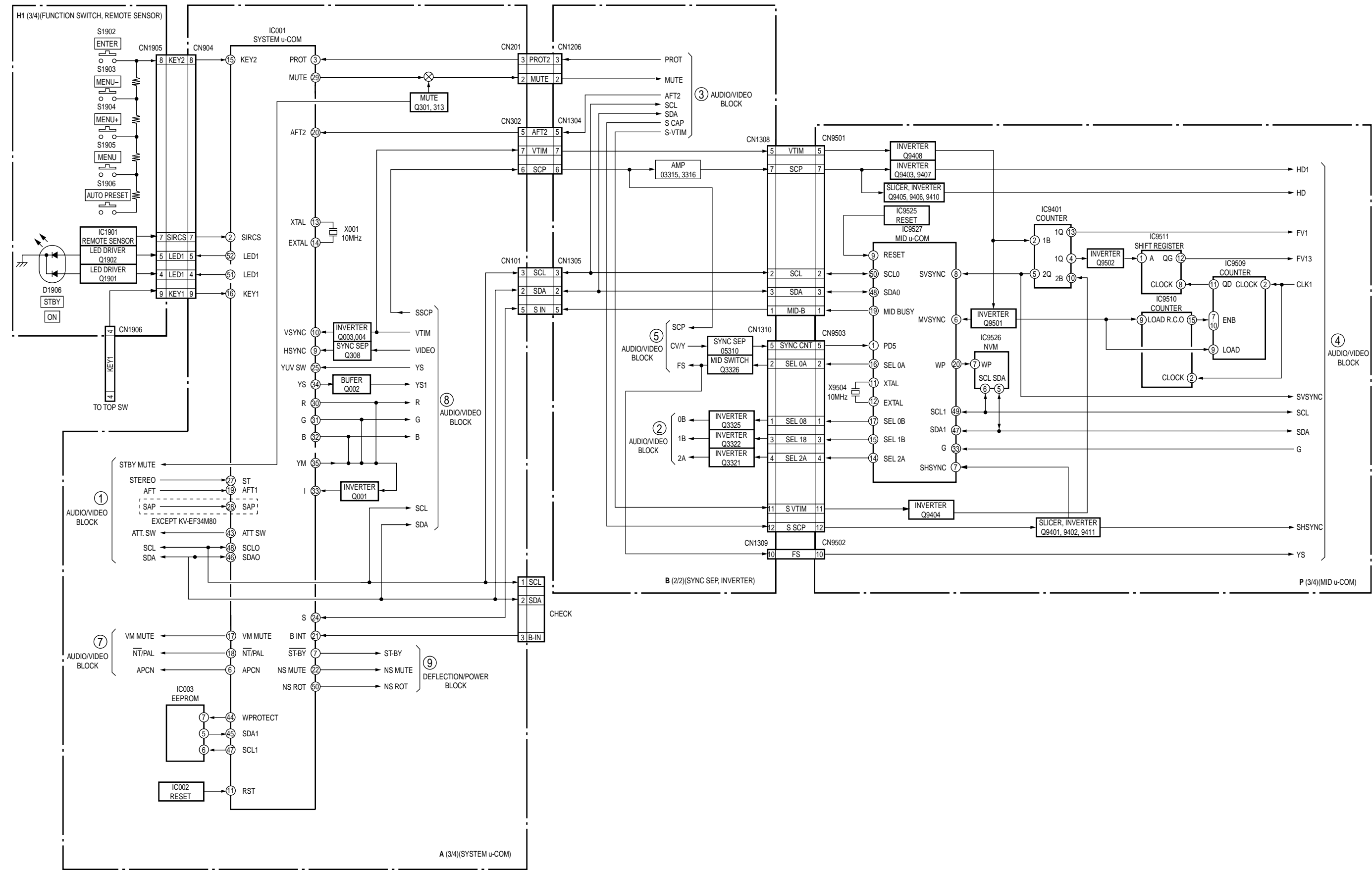

5-2. FRAME SCHEMATIC DIAGRAM

KV-EF34M80 RM-951 KV-EF34M80 RM-951

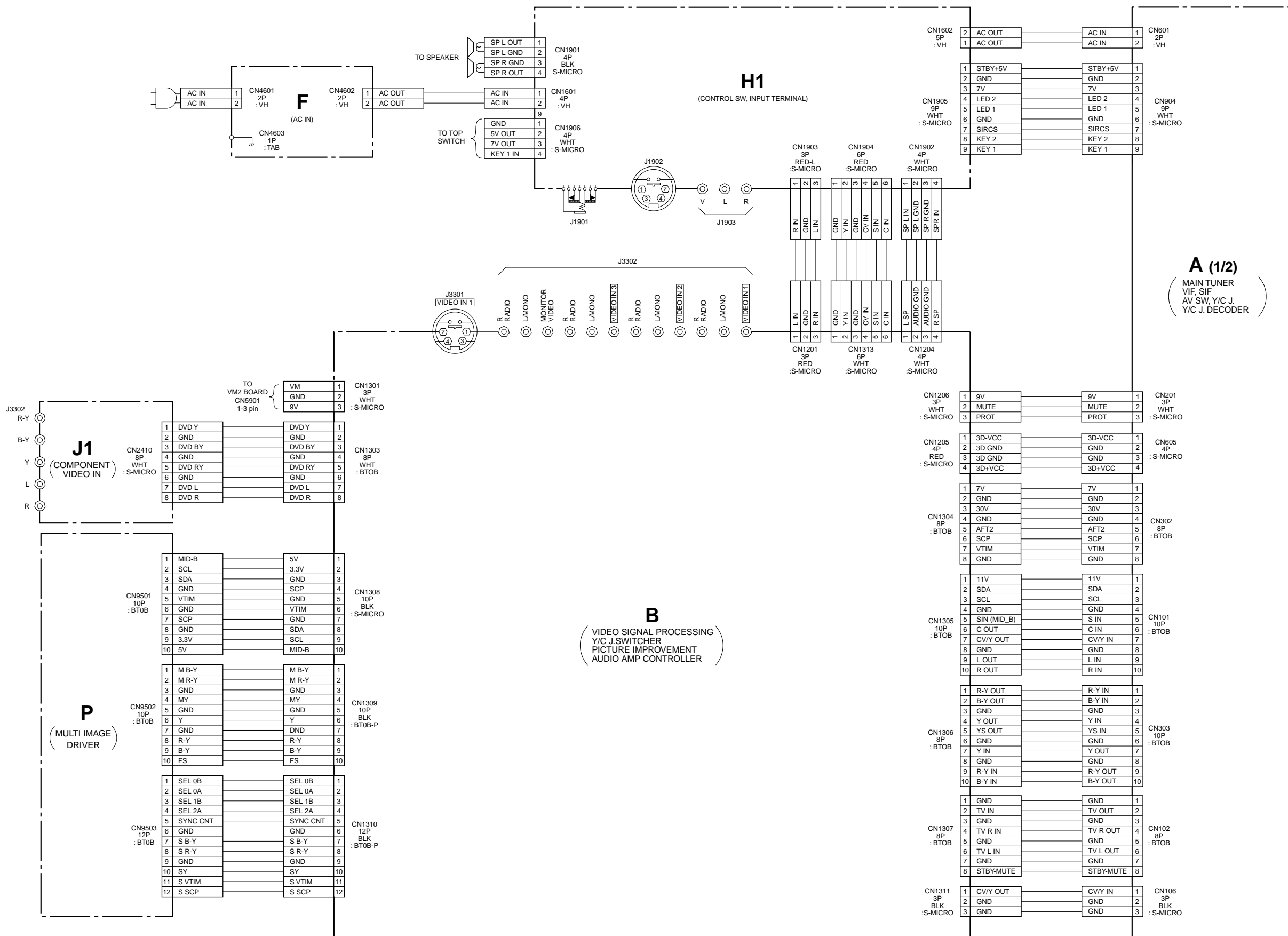

A (1/2)
MAIN TUNER
VIF, SIF
AV SW, Y/C J.
Y/C J. DECODER

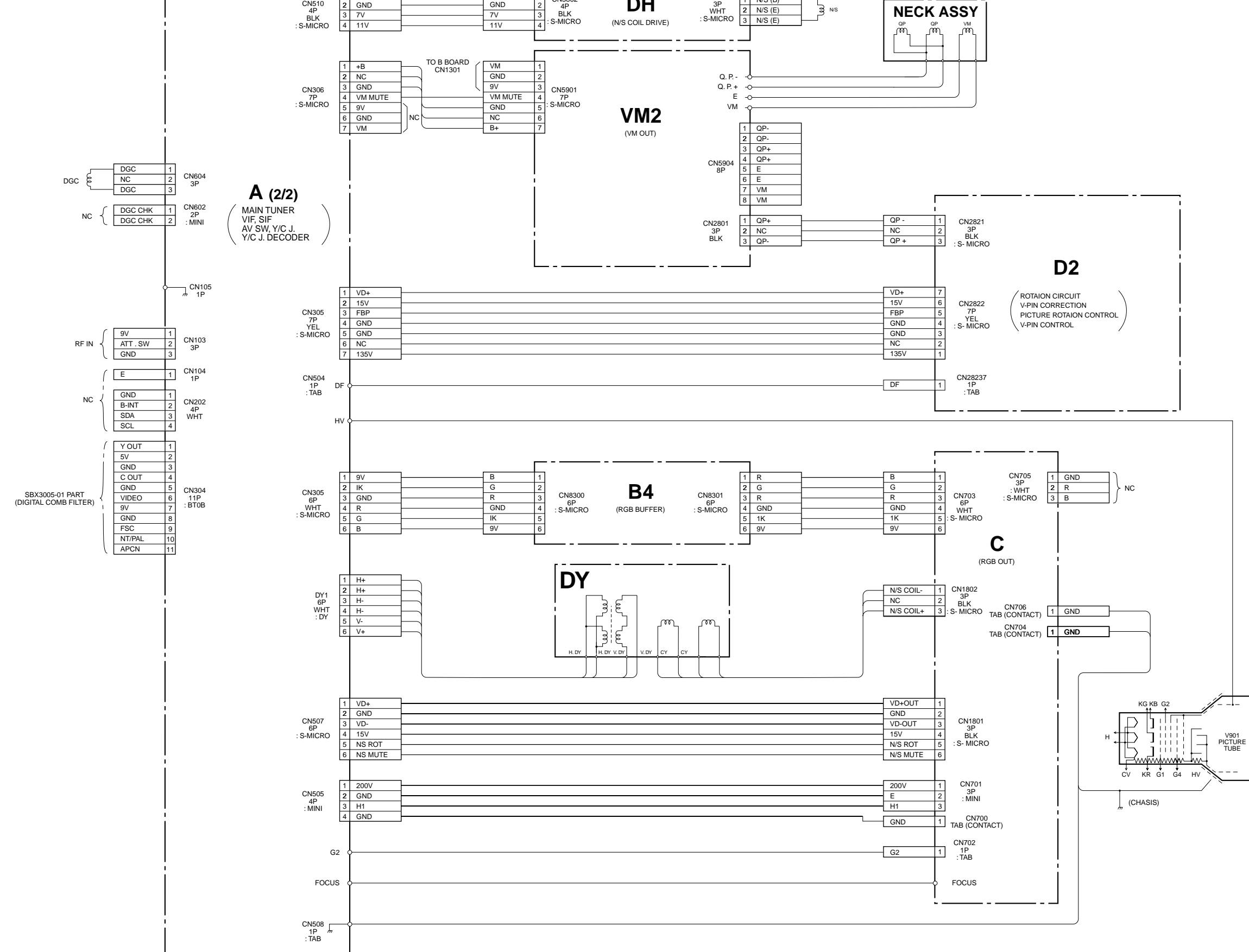

A (2/2)
MAIN TUNER
VIF, SIF
AV SW, Y/C J.
Y/C J. DECODER

D2
ROTATION CIRCUIT
V-PIN CORRECTION
PICTURE ROTATION CONTROL
V-PIN CONTROL

KV-EF34M80 RM-951 KV-EF34M80 RM-951

5-3. CIRCUIT BOARDS LOCATION

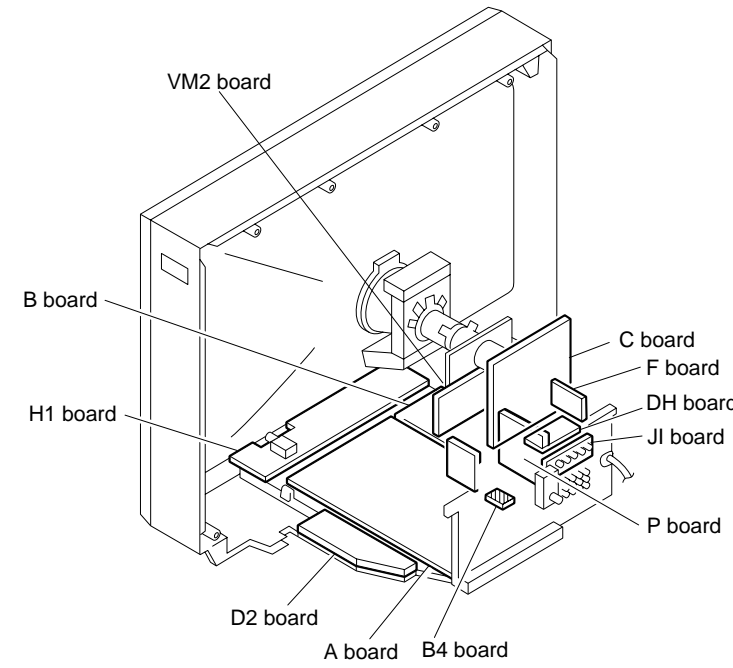

5-4. SCHEMATIC DIAGRAMS AND PRINTED WIRING BOARDS

Note:

- All capacitors are in μF unless otherwise noted.
- All electrolytic capacitors are rated at 50V unless otherwise noted.
- All resistors are in ohms.
- k = 1000, M = 1000k
- Indication of resistance which does not have rating electrical power is as follows.
- Pitch: 5 mm
- Rating electrical power 1/4W (CHIP: 1/10W)
- ⚡ : nonflammable resistor.
- △ : internal component.
- : panel designation or adjustment for repair.
- All variable and adjustable resistors have characteristic curve B unless otherwise noted.
- Readings are taken with a color-bar signal input.
- no mark : PAL
- () : SECAM
- [] : NTSC 3.58
- « » : NTSC 4.43
- Readings are taken with a 10 M digital m ultimeter.
- Voltage are dc with respect to ground unless otherwise noted.
- Voltage variations may be noted due to normal production tolerances.
- All voltages are in V.
- * : Cannot be measured.
- Circled numbers are waveform references.
- +— : B + bus.
- : B - bus.
- ⇒ : signal path.

Reference information

RESISTOR : RN	METAL FILM
: RC	SOLID
: FPRD	NONFLAMMABLE CARBON
: FUSE	NONFLAMMABLE FUSIBLE
: RS	NONFLAMMABLE METAL OXIDE
: RB	NONFLAMMABLE CEMENT
: RW	NONFLAMMABLE WIREWOUND
: *	ADJUSTMENT RESISTOR
COIL : LF-8L	MICRO INDUCTOR
CAPACITOR : TA	TANTALUM
: PS	STYROL
: PP	POLYPROPYLENE
: PT	MYLAR
: MPS	METALIZED POLYESTER
: MPP	METALIZED POLYPROPYLENE
: ALB	BIPOLAR
: ALT	HIGH TEMPERATURE
: ALR	HIGH RIPPLE

Note: The component identified by shading and mark △ are critical for safety. Replace only with part number specified.

A BOARD

IC	D004	D-8	D614	H-7																																																																																												
IC001	B-10	D005	B-8	D615	E-7																																																																																											
IC002	C-9	D006	A-3	D616	E-9																																																																																											
IC003	A-9	D203	C-11	D617	F-8																																																																																											
IC100	B-5	D300	A-9	D618	F-8																																																																																											
IC201	B-11	D301	B-9	D620	D-8																																																																																											
IC203	C-3	D302	B-6	D621	F-8																																																																																											
IC204	B-2	D303	B-5	D622	F-7																																																																																											
IC301	B-6	D304	B-5	D623	F-12																																																																																											
IC502	E-6	D305	B-5	D624	F-12																																																																																											
IC503	J-5	D306	C-5	D625	D-12																																																																																											
IC601	I-8	D307	C-5	D627	F-8																																																																																											
IC602	H-6	D308	B-5	D628	G-5																																																																																											
IC603	D-8	D309	B-6	D629	F-9																																																																																											
IC604	D-10	D310	A-6	D630	E-9																																																																																											
IC901	I-13	D311	C-6	D631	G-12																																																																																											
PH600	H-7	D312	C-6	D632	F-12																																																																																											
		D313	A-8	D633	E-12																																																																																											
		D315	B-7	D634	F-11																																																																																											
		D316	C-7	D635	F-12																																																																																											
		D317	B-9	D636	D-12																																																																																											
		D314	A-9	D637	F-11																																																																																											
		D319	C-6	D638	E-11																																																																																											
		D320	C-6	D901	C-13																																																																																											
		D321	B-6	D902	D-13																																																																																											
		D401	D-2	D903	C-13																																																																																											
		D402	C-3	D904	D-13																																																																																											
		D403	B-1	D905	F-13																																																																																											
		D404	C-2	D906	F-13																																																																																											
		D405	C-1																																																																																													
		D406	B-1																																																																																													
		D407	C-2																																																																																													
		D408	C-1																																																																																													
		D409	A-1																																																																																													
		D504	D-5																																																																																													
		D505	H-6																																																																																													
		D506	F-6																																																																																													
		D507	F-6																																																																																													
		D508	I-5																																																																																													
		D509	E-6																																																																																													
		D510	F-5																																																																																													
		D511	F-5																																																																																													
		D512	G-5																																																																																													
		D513	I-5																																																																																													
		D517	F-2																																																																																													
		D518	F-2																																																																																													
		D519	F-2																																																																																													
		D520	E-5																																																																																													
		D521	I-4																																																																																													
		D522	J-4																																																																																													
		D525	F-5																																																																																													
		D526	F-6																																																																																													
		D527	F-3																																																																																													
		D528	F-3																																																																																													
		D529	F-5																																																																																													
		D530	F-2																																																																																													
		D531	E-6																																																																																													
		D532	E-6																																																																																													
		D533	D-2																																																																																													
		D534	E-6																																																																																													
		D600	G-13																																																																																													
		D601	I-8																																																																																													
		D602	G-13																																																																																													
		D603	F-11																																																																																													
		D604	J-7																																																																																													
		D605	G-10																																																																																													
		D606	E-11																																																																																													
		D607	F-10																																																																																													
		D608	E-11																																																																																													
		D609	H-8																																																																																													
		D610	J-8																																																																																													
		D611	I-7																																																																																													
		D612	F-8																																																																																													
		D613	I-7																																																																																													
TRANSISTOR	Q001	B-8	Q002	B-8	Q003	C-9	Q004	C-9	Q101	A-4	Q201	A-11	Q202	A-11	Q203	C-11	Q204	C-11	Q205	A-12	Q206	A-11	Q207	A-11	Q301	B-8	Q302	A-6	Q303	A-6	Q304	B-6	Q305	B-5	Q306	B-5	Q307	C-7	Q308	C-7	Q309	C-7	Q310	D-7	Q311	D-9	Q312	B-7	Q313	B-8	Q315	B-5	Q401	D-2	Q402	D-1	Q403	D-2	Q404	C-3	Q501	D-6	Q502	E-7	Q503	F-6	Q505	D-6	Q506	D-2	Q507	H-6	Q509	F-6	Q511	F-1	Q600	C-12	Q601	F-11	Q602	J-7	Q603	I-7	Q604	H-6	Q605	E-12	Q606	F-11	Q607	H-13	Q901	H-13	Q902	H-13
DIODE	D001	B-8	D002	C-8	D003	C-9																																																																																										

A MAIN TUNER, VIF, SIF, AV SW Y/C DECODE JUNGLE, POWER SUPPLY, DEFLECTION

PRINTED WIRING BOARD

- A Board -

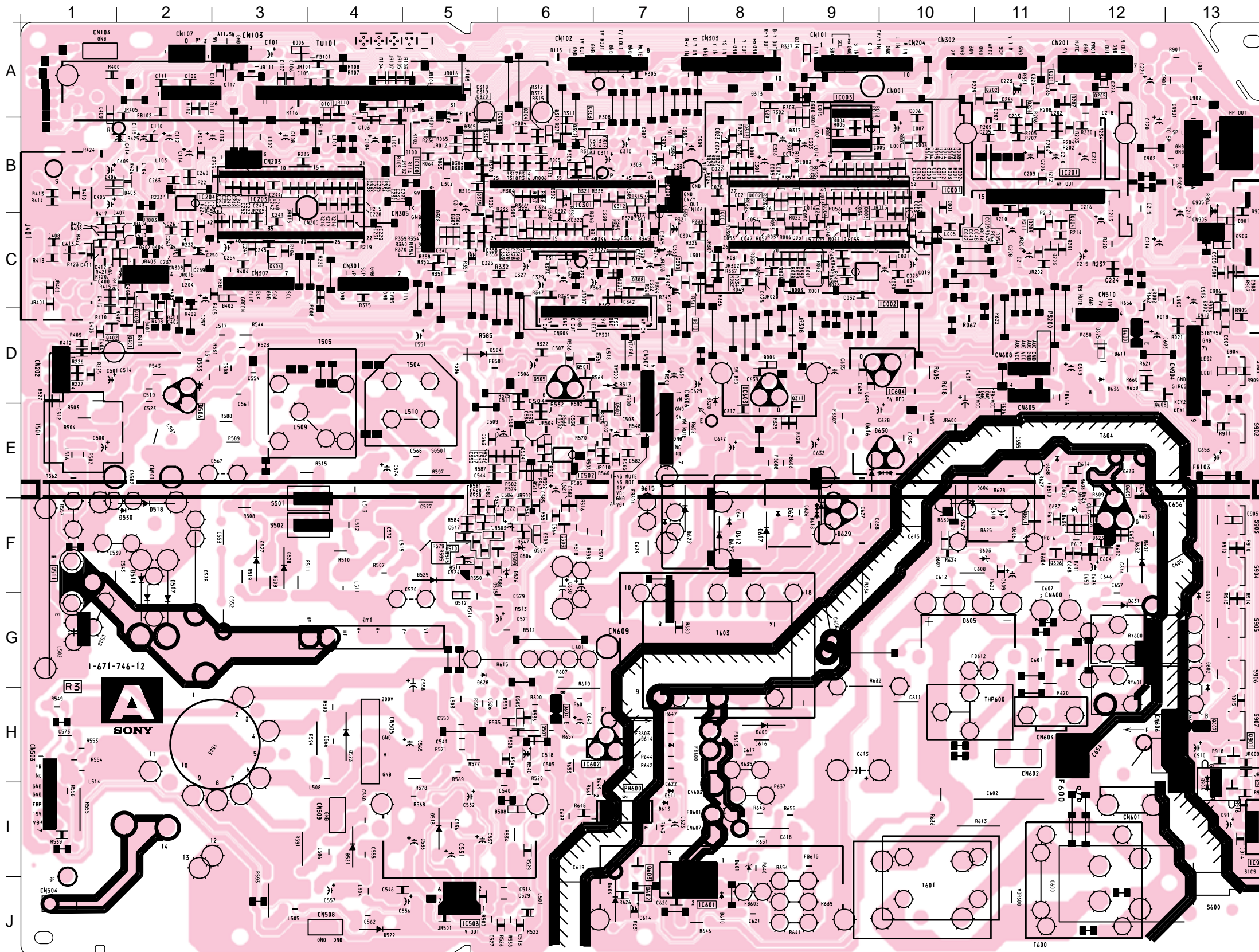

NOTE: The circuit indicated at left contains high voltage of over 600 Vp-p. Please pay attention when inspecting or repairing it to prevent an electric shock.

(1) Schematic Diagram of A(2/2) Board

1 2 3 4 5 6 7 8 9 10 11 12 13 14 15 16 17 18 19 20 21 22 23 24 25 26 27 28 29 30

A
B
C
D
E
F
G
H
I
J

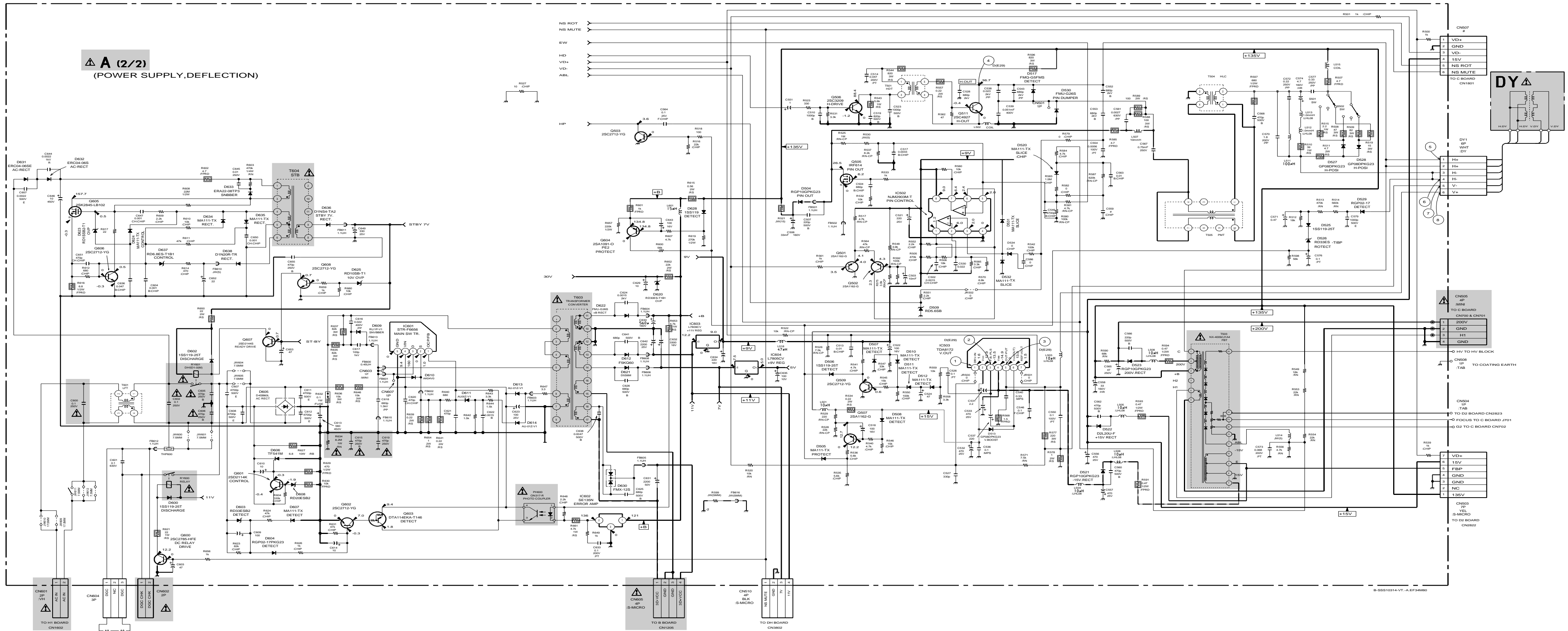

A BOARD WAVEFORMS (2/2)

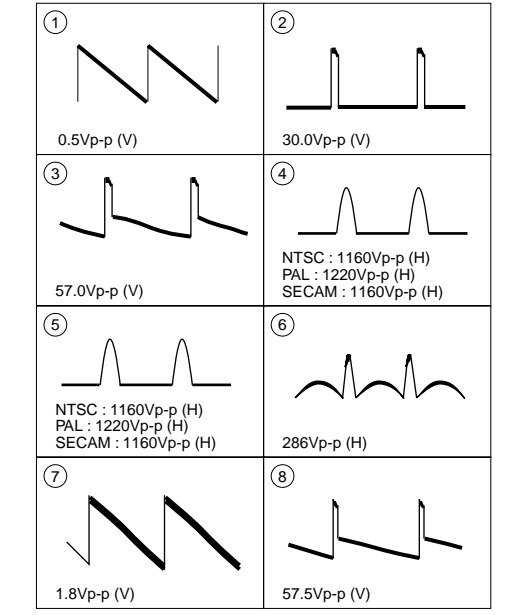

B BOARD WAVEFORMS (1/2)

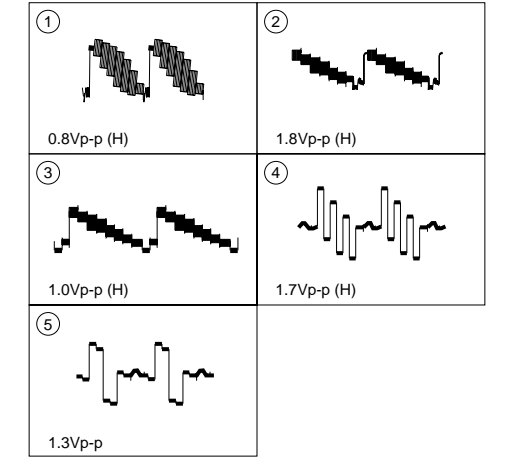

A BOARD IC1308 HEF4053BT

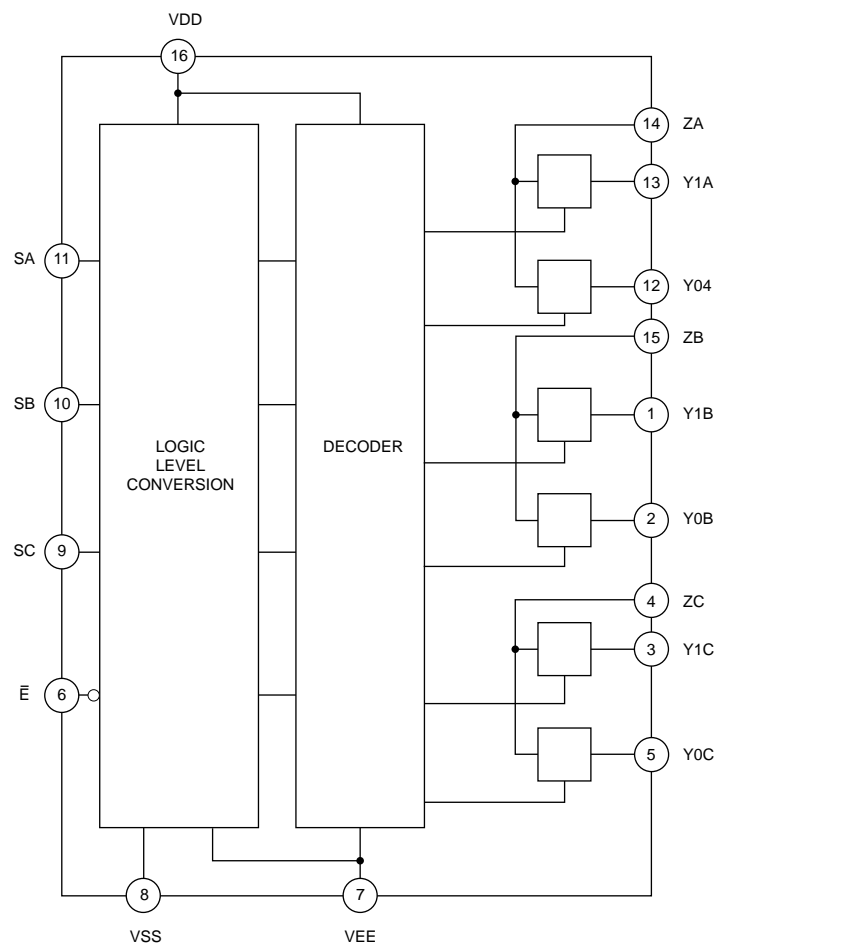

B VIDEO SIGNAL PROCESSING, Y/C/I SWITCHER,
PICTRE IMPROVEMENT, AUDIO AMP CONTROLLER

F [AC IN]

PRINTED WIRING BOARDS

- B Board -

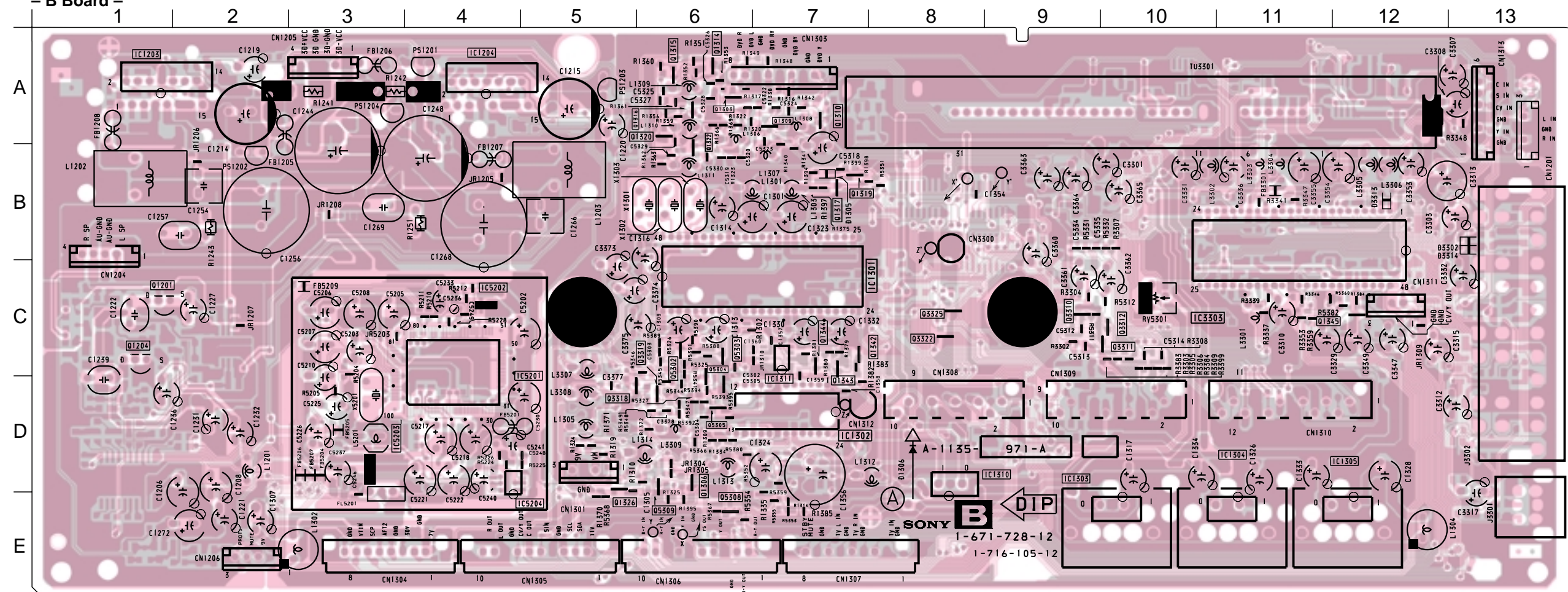

- :Pattern from the side which enables seeing.
- :Pattern of the rear side.

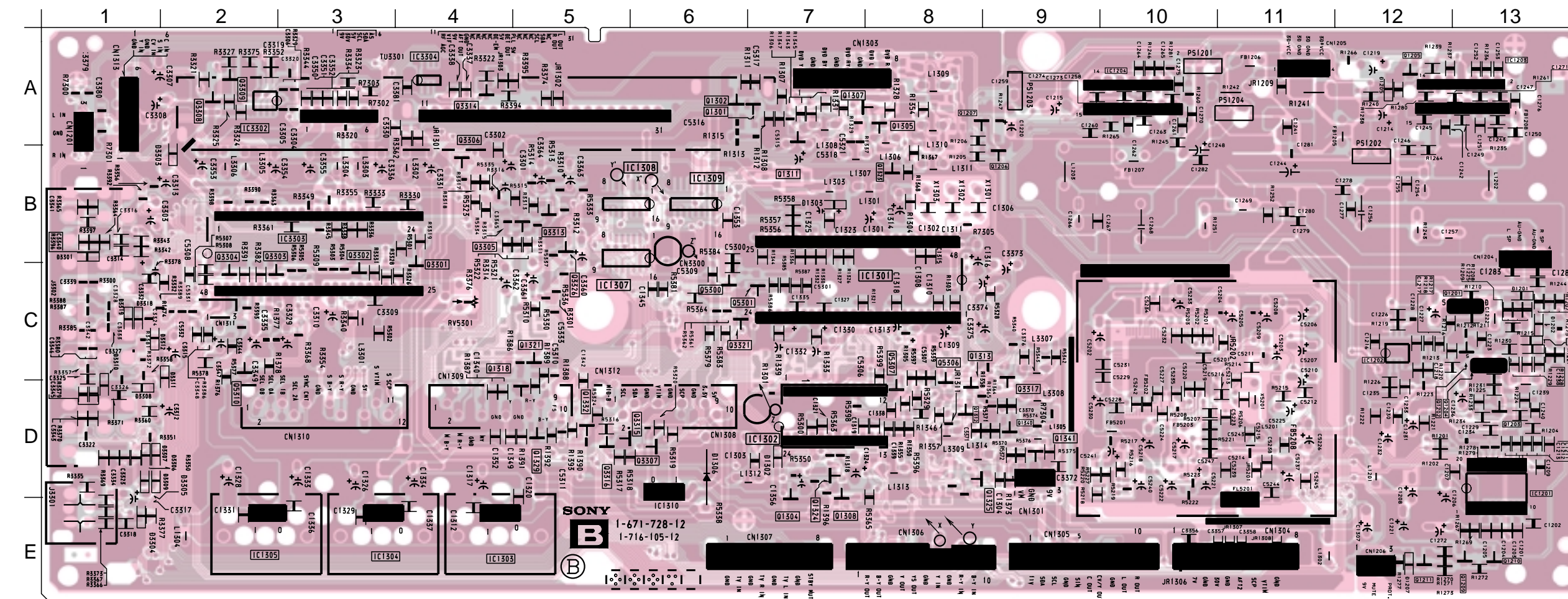

- F Board -

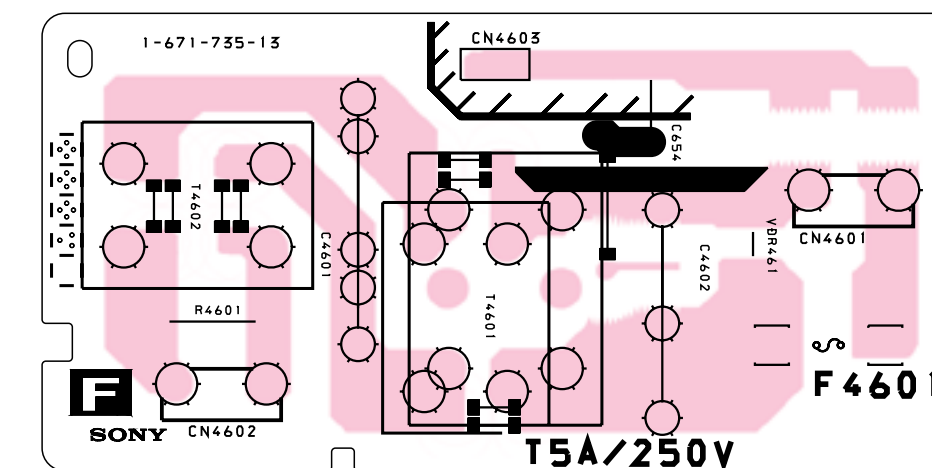



PRINTED WIRING BOARDS

- P Board -

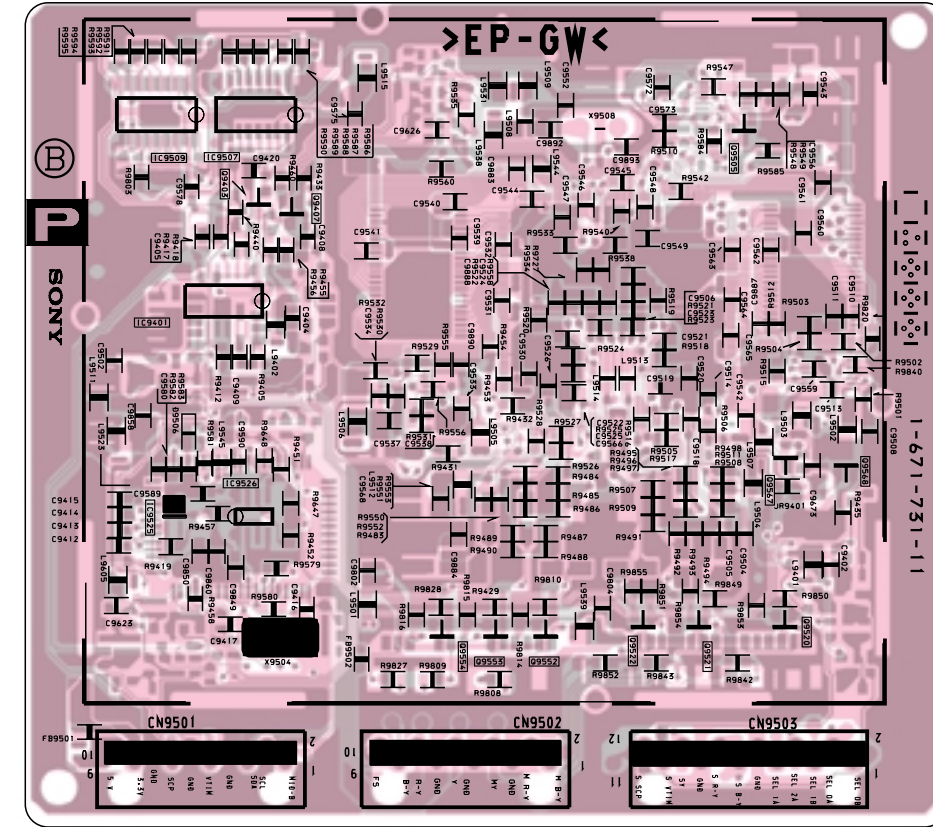
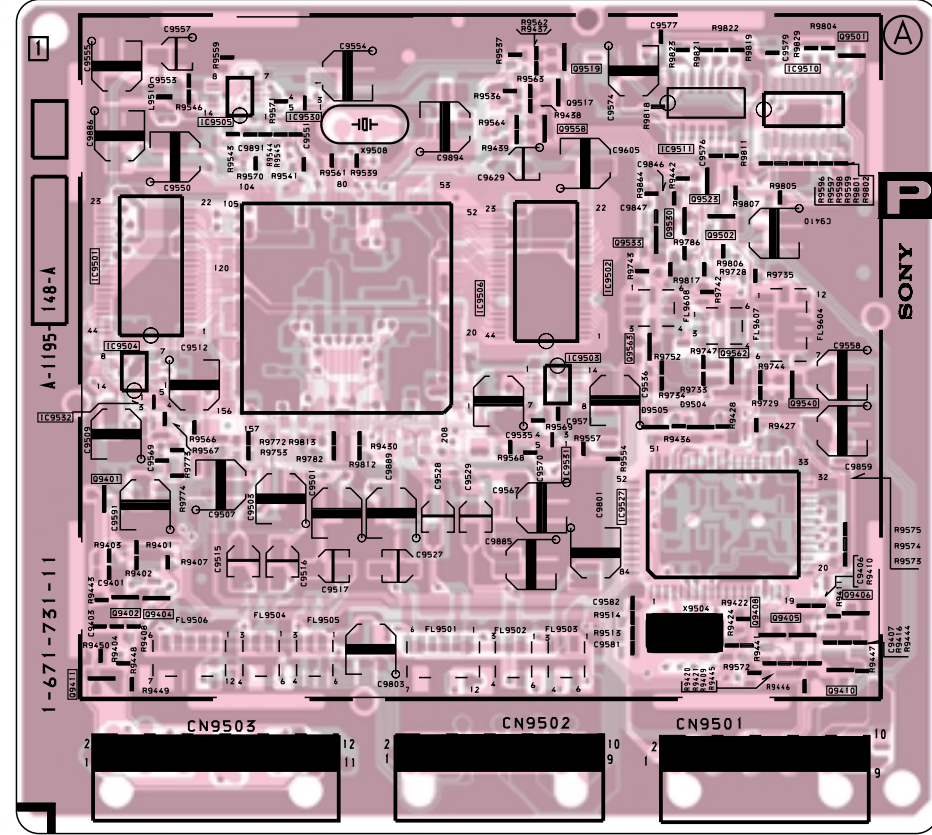

- :Pattern from the side which enables seeing.
- :Pattern of the rear side.

P BOARD IC9506 CXD2079Q

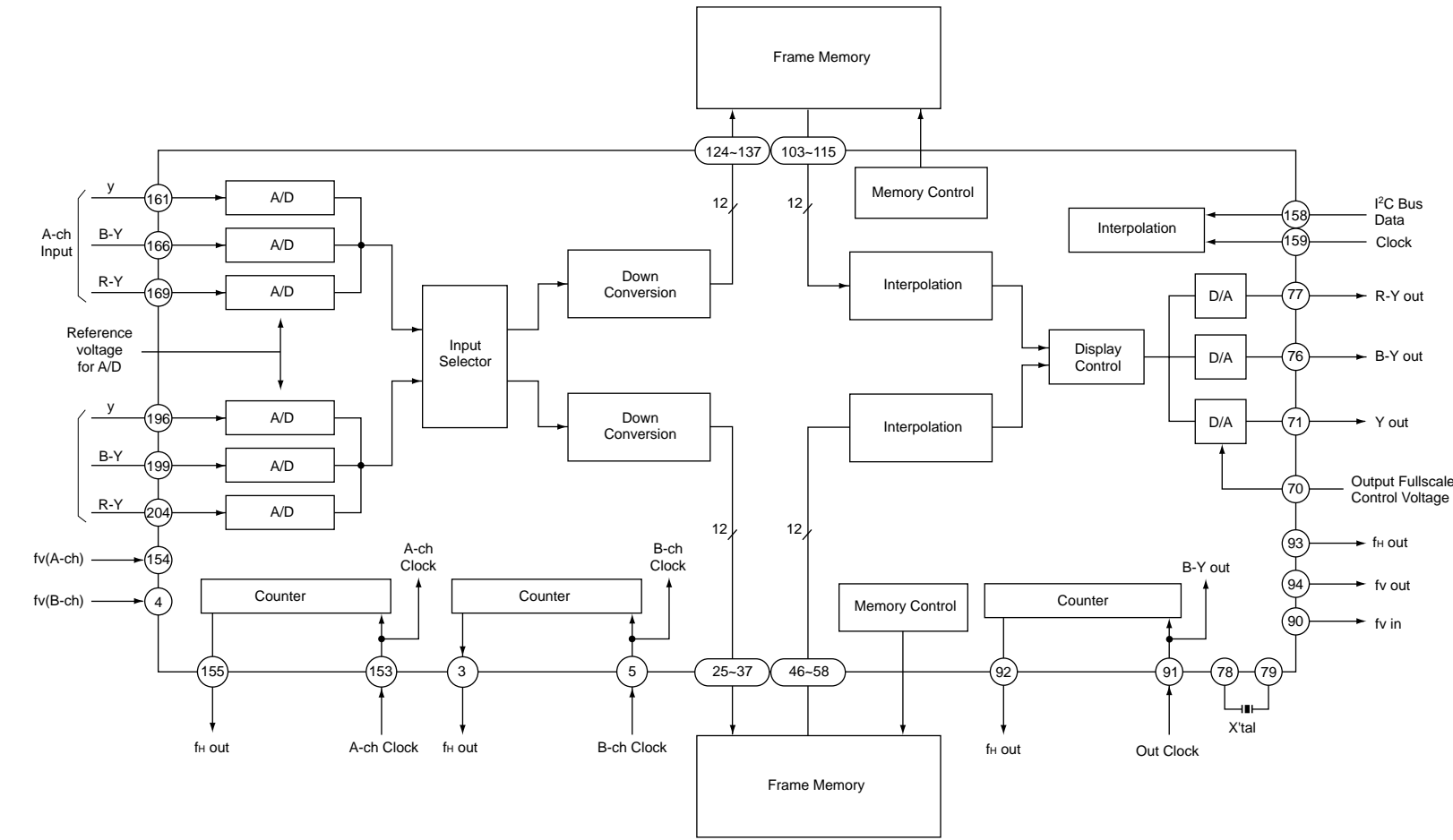

P BOARD WAVEFORMS

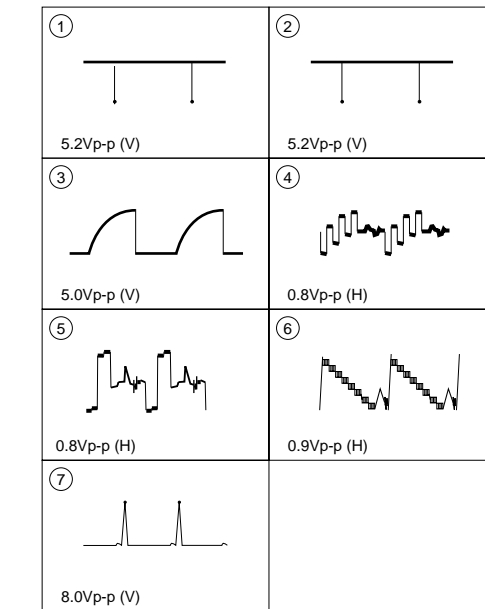

H1 [POWER SUPPLY, HV, MICON, Y/C JUNGLE] **C** [RGB OUT]

PRINTED WIRING BOARDS

– H1 Board –

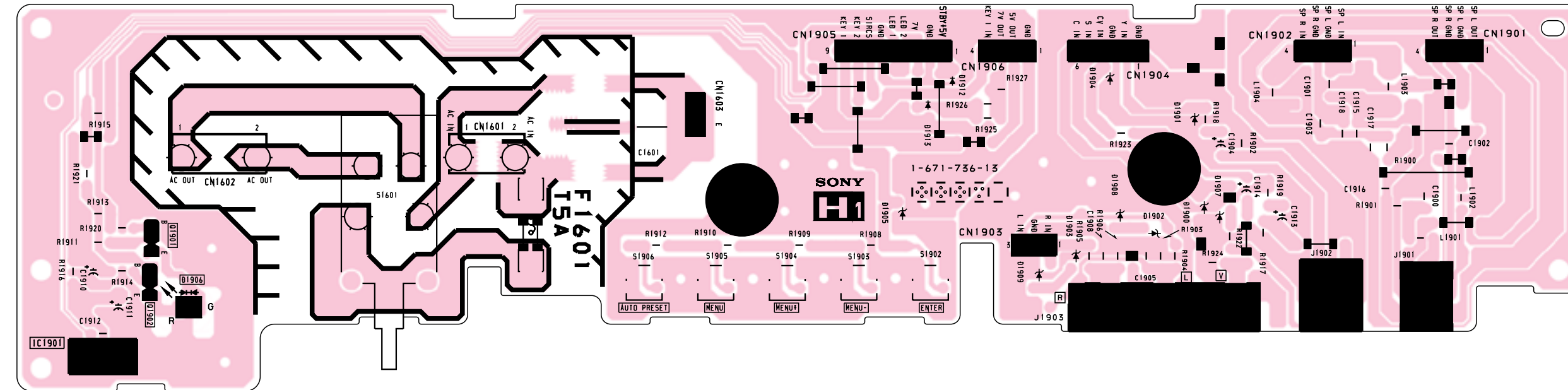

– C Board –

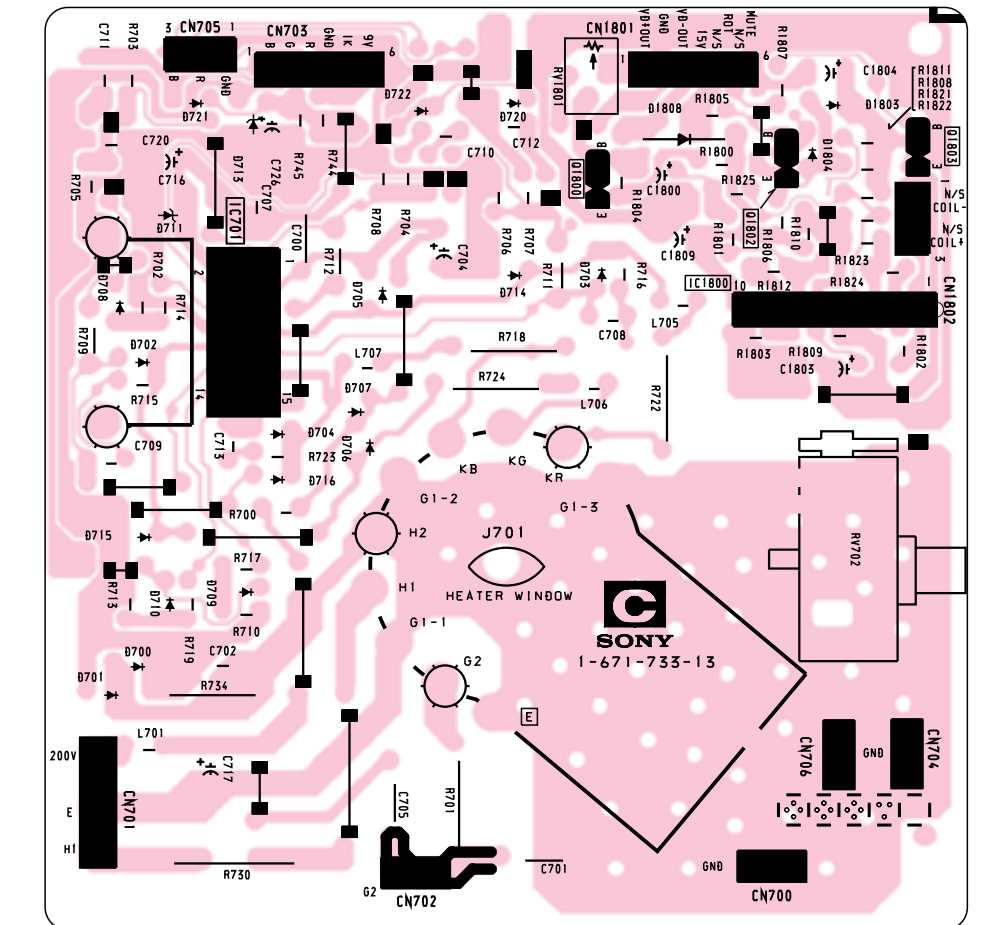

C BOARD WAVEFORMS

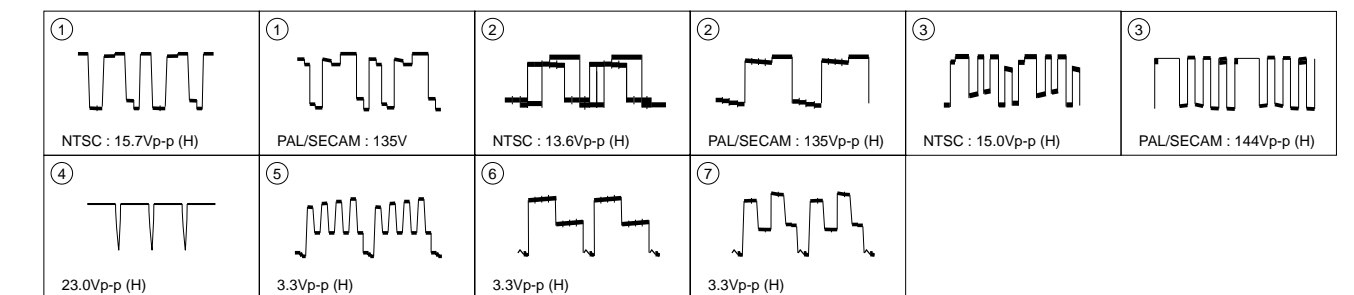

(9) Schematic Diagrams of DH and VM2 boards

1 2 3 4 5 6 7 8 9 10 11 12 13 14 15 16 17 18 19 20 21 22

A
B
C
D
E
F
G
H
I
J

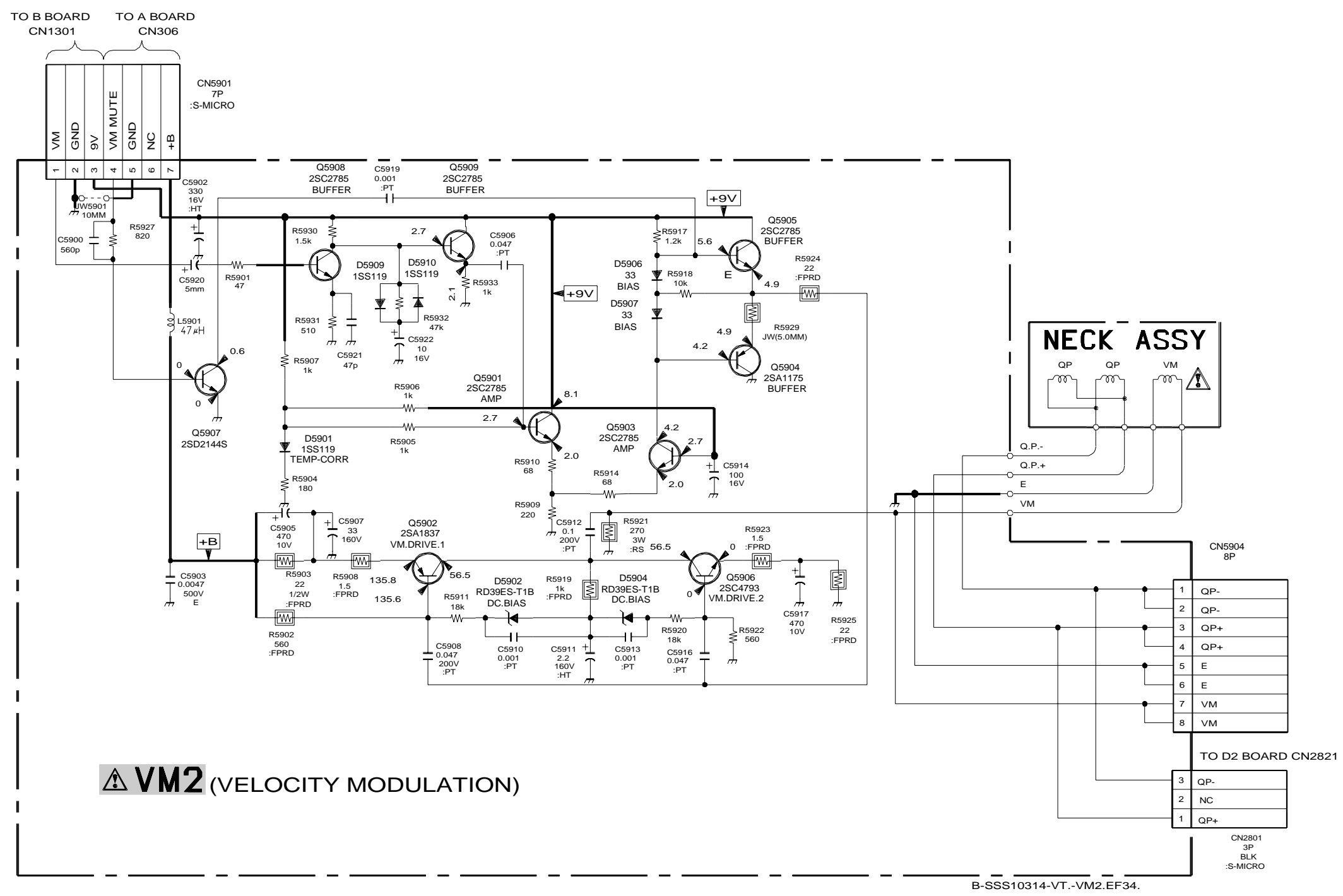
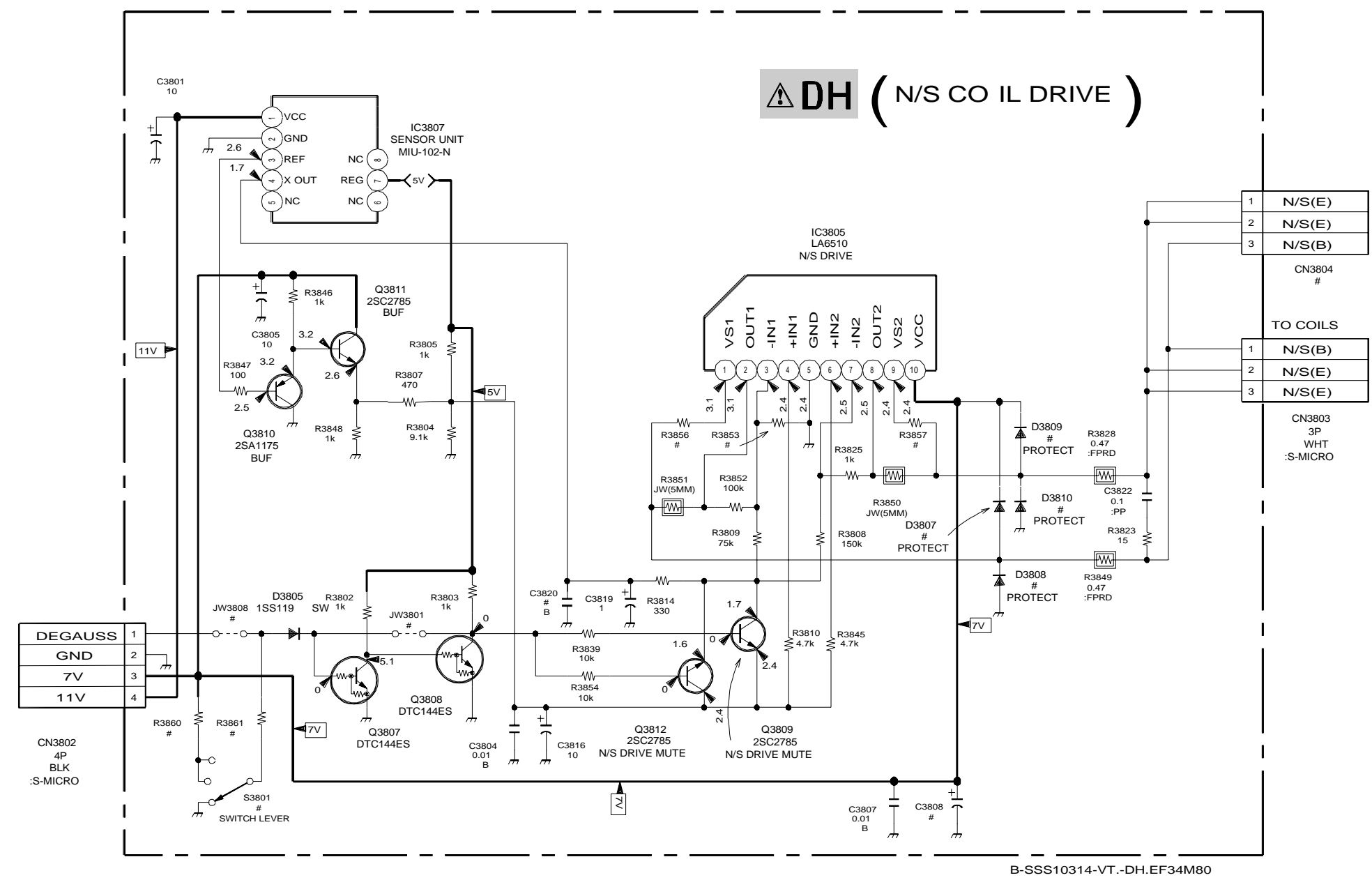

VM2 [VELOCITY MODULATION]

DH [MAGNETIC FIELD CORRECTION]

PRINTED WIRING BOARDS

– VM2 Board –

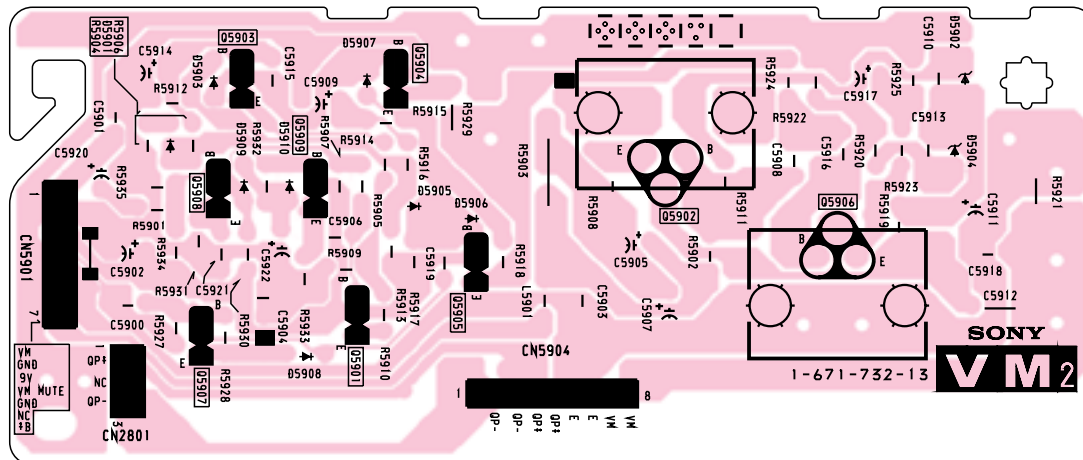

– DH Board –

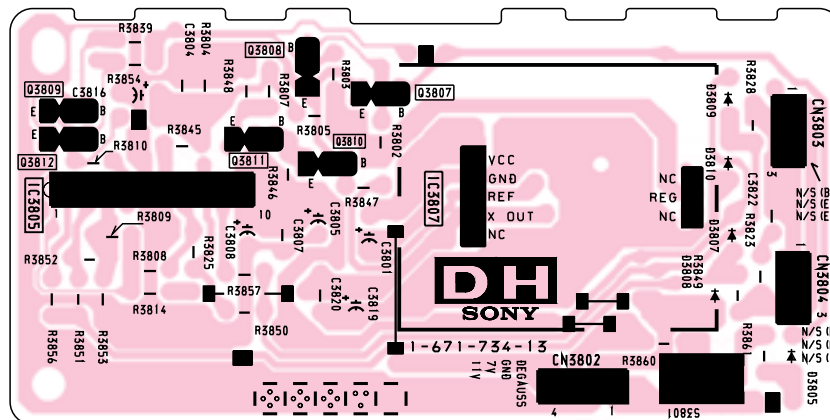

D2 [DF, DQP DRIVE]

PRINTED WIRING BOARD

– D2 Board –

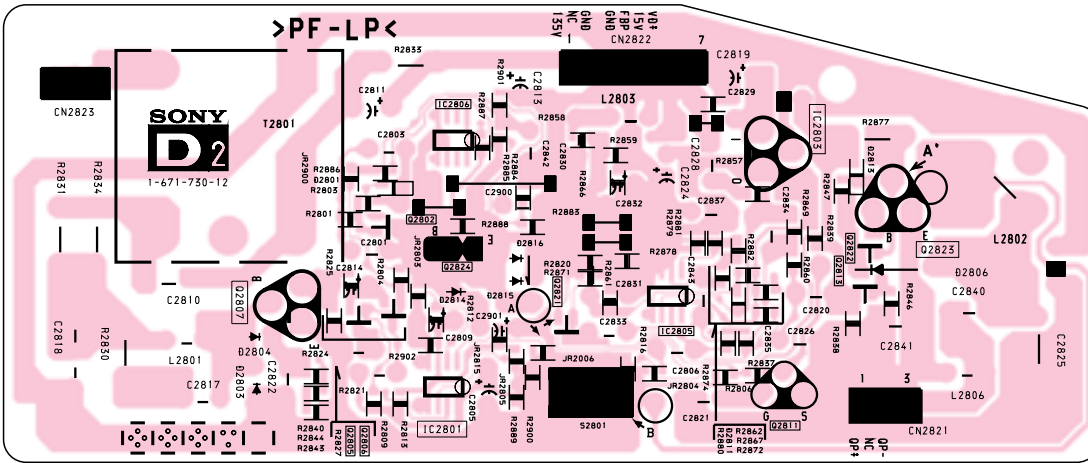

D2 BOARD WAVEFORMS

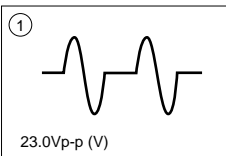

(10) Schematic Diagram of D2 board

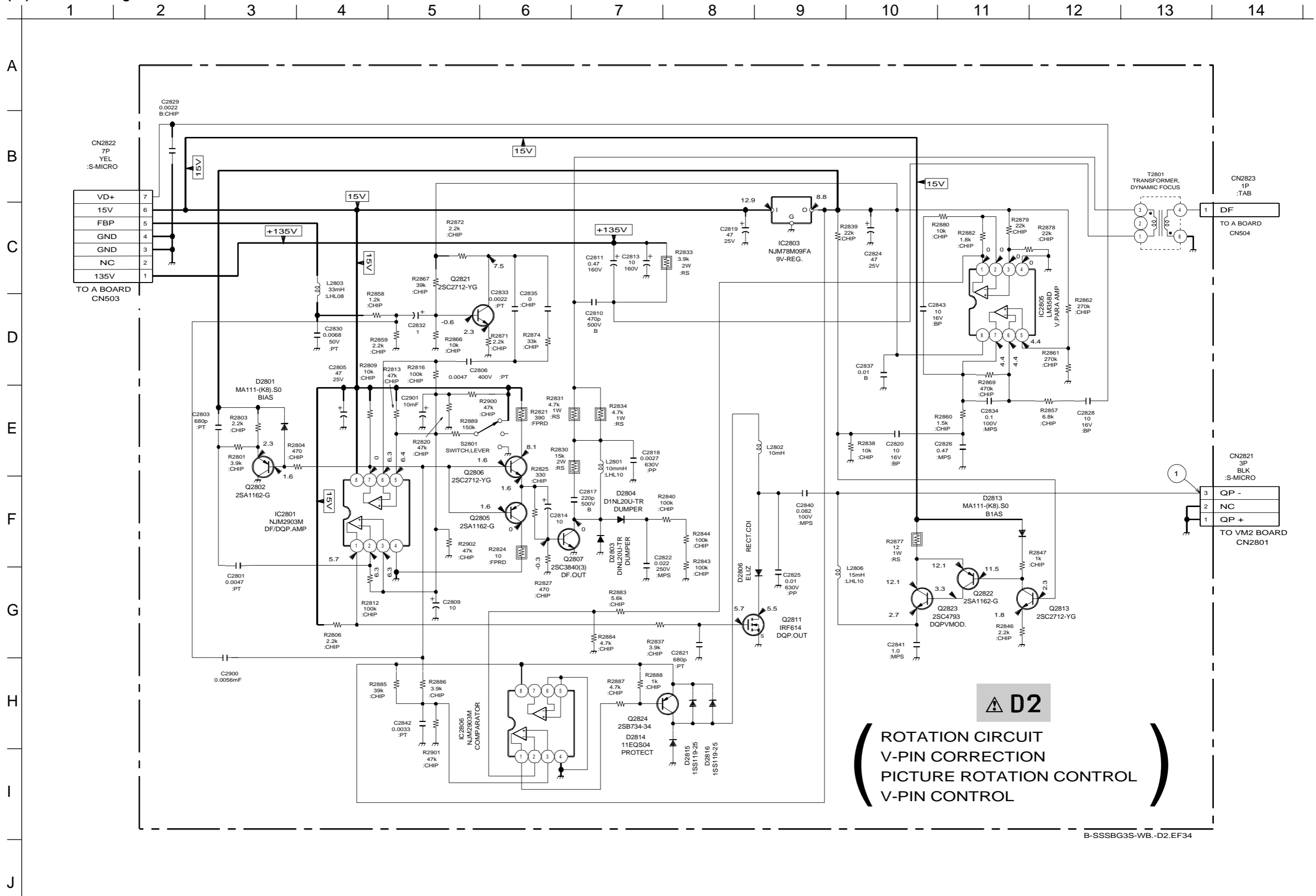

D2
 (ROTATION CIRCUIT
 V-PIN CORRECTION
 PICTURE ROTATION CONTROL
 V-PIN CONTROL)

5-5. SEMICONDUCTORS

DIODE

AK04V0
D2L20U
EL1Z
ERA22-08
HSS83TD
GP08D
RGP02-17EL-6433

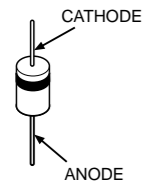

ERC04-06SE

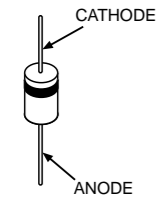

FMU-G26S

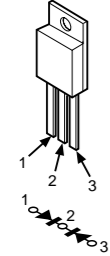

D5S6M

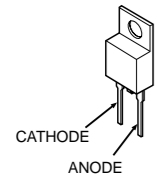

ON3171-R

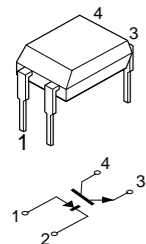

D1NS4
D1N20R
RD11ES-B3
RD39ES-B2
RD9.1ES-L2
1SS119-25
11EQS04

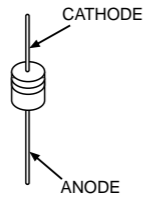

DTZ10B
DTZS-TE17-5.1B
DTZS-TE17-9.1B
MA111-TX(K8).S0
RD5.1SB-T2M
RD5.65-B
1SS355TE-17

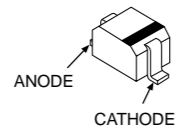

5P6M

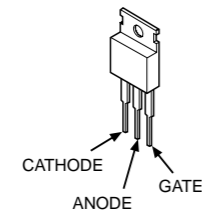

D1NL20U-TR

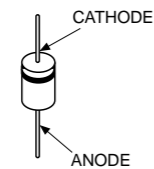

02CZ6.2-TE85L

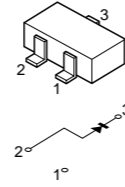

RD15SB2

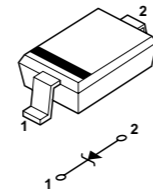

LED

SPB-26MVWF

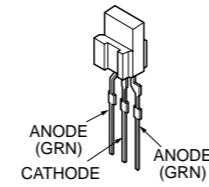

TRANSISTOR

DTA114EKA-T146
DTC114EK
TR DTC144EKA
2SSA103AK-T146-R
2SA1162-G
2SC2712-YG
2SSD2114K

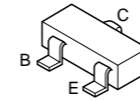

DTC144ESA
2SA1175-HFE
2SC2785-HFE

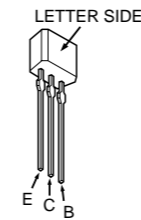

2SA1091-0

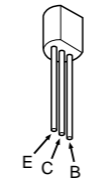

2SA1606-E
2SC4159-E
2SC4793

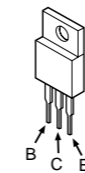

2SD2144S-UVM



2SC4927-01

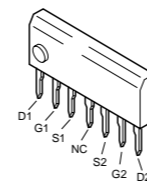

IRF614

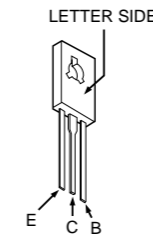

2SK246-GR



2SK2845-LB102

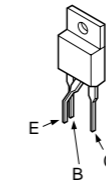

2SB734-34

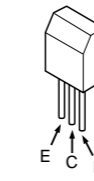

2SC2688-LK
2SC3840(3)

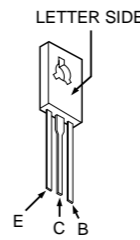

CXD2079Q
MSM548331TS-K (100PIN)

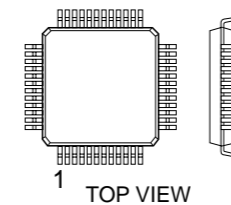

IC

CXA1855S (48PIN)
CXA2139S (48PIN)
CXP750097-006S (64PIN)
M24C02-MN6T (8PIN)
M24 C08-BN6 (8PIN)
STV5112 (15PIN)
TDA7481 (15PIN)
TDA9178 (15PIN)

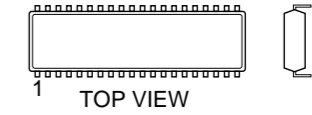

Dual In-line Package
Pin 6~98

BA10358F-E2 (8PIN)
BA7606F (16PIN)
HEF4053BT (16PIN)
MC74HC163AFEL (16PIN)
MM1115XFBE (8PIN)
MM1319AFBE (7PIN)
NJM2903M (8PIN)
SN74LS22INS (16PIN)
TDA7315D013TR (20PIN)
TLC29321PW (14PIN)
μPC4558G2 (8PIN)

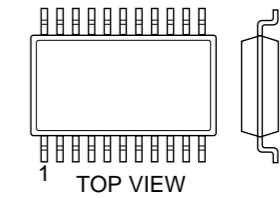

Single In-line Package
Pin 6~98

NJM78M05DLA (TE1)
NJM78M09FA
TA7805S

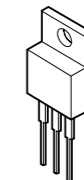

SBX1981-51P

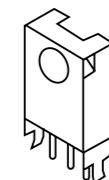

SE-135N

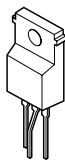

FMX-12S

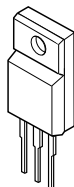

TDA8172

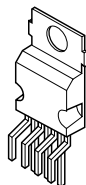

BA033T
BA05T

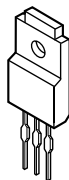

LA6510

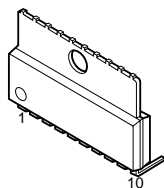

TC9447F-003

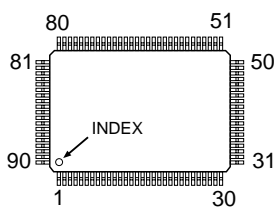

TOP VIEW

STR-F6656

MARKING SIDE VIEW

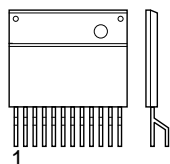

Zig-zag In-line Package
Pin 6~99

CXP86332-018Q

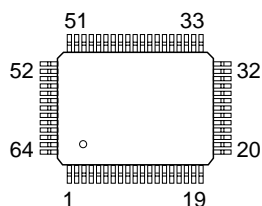

TOP VIEW

S-80743AL-A7-3

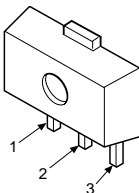

FMQ-G5FMS

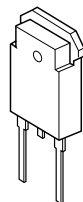

PST9143NL-(5PIN)
TC7SET08FU(TE85L)-(5PIN)

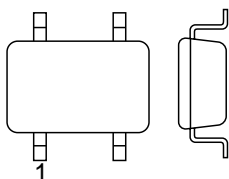

SECTION 6 EXPLODED VIEWS

NOTE:

- Items with no part number and no description are not stocked because they are seldom required for routine service.
- The construction parts of an assembled part are indicated with a collation number in the remark column.
- Items marked "*" are not stocked since they are seldom required for routine service. Some delay should be anticipated when ordering these items.

The components identified by shading and mark \triangle are critical for safety. Replace only with part number specified.

6-1. PICTURE TUBE

- : 7-685-663-71 SCREW +BVTP 4 × 16
- : 7-685-648-79 SCREW +BVTP 3 × 12

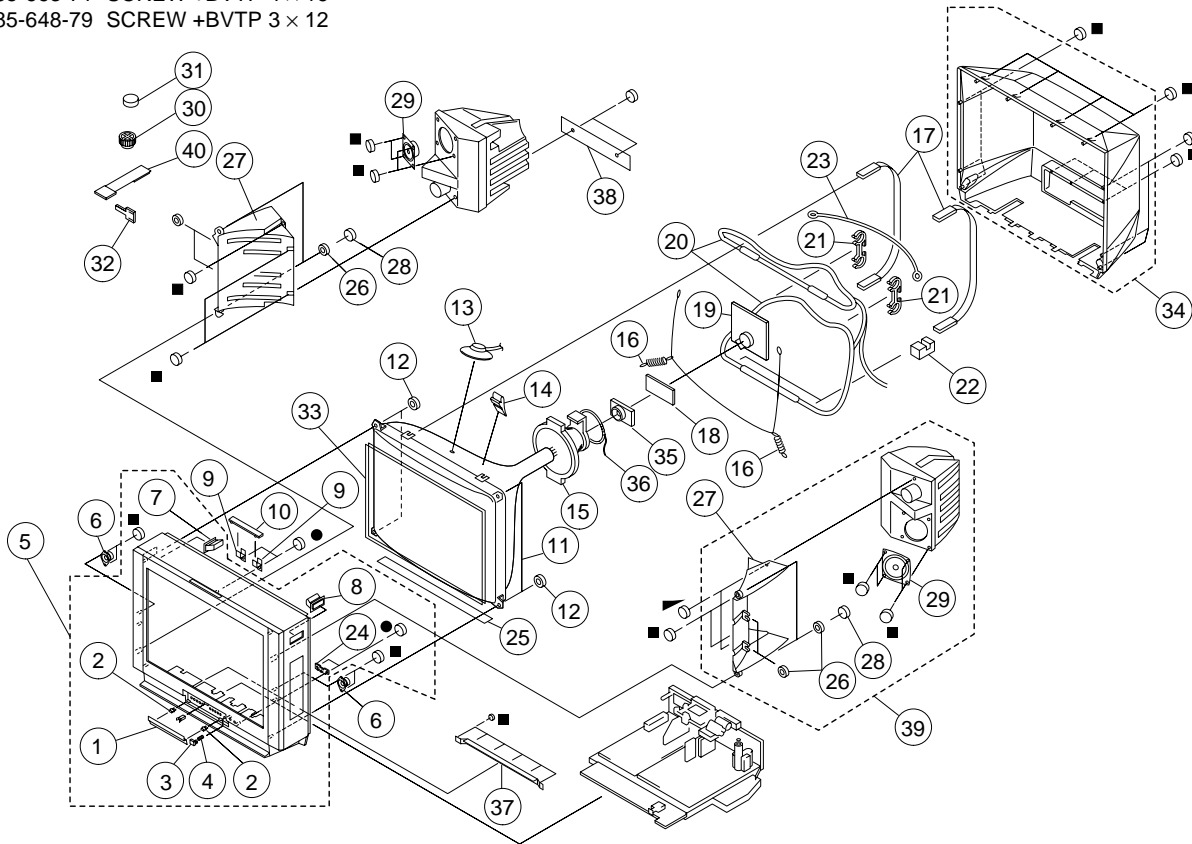

REF. NO.	PART NO.	DESCRIPTION	REMARK	REF. NO.	PART NO.	DESCRIPTION	REMARK
1	X-4036-264-1	DOOR ASSY, CONTROL		21	4-067-087-01	HOLDER (C), DGC	
2	4-045-250-21	DAMPER		22	* 4-062-938-01	SUPPORTER, CRT	
3	4-062-942-01	BUTTON, POWER		23	4-067-455-01	BAND, DGC	
4	4-036-405-01	SPRING, COMPRESSION		24	* 4-062-939-02	GUIDE, LIGHT	
5	X-4036-268-2	BEZNET ASSY	1-4, 7, 8, 24	25	4-072-570-01	SHEET, BLOTTING	
6	1-505-474-11	SPEAKER (5CM)		26	4-374-745-21	CUSHION (A)	
7	X-4035-873-2	HANDLE ASSY (LEFT)		27	4-066-041-01	DUCT, SPEAKER	
8	X-4035-874-2	HANDLE ASSY (RIGHT)		28	4-064-929-02	SCREW, TP+TWH 4X25	
9	* 4-062-943-01	HOLDER, TOP SWITCH		29	1-505-473-11	SPEAKER (12CM)	
10	1-771-360-11	SWITCH, TOP		30	1-452-094-00	CIRCULAR DISC MAGNET B	
11	\triangle 8-735-063-05	PICTURE TUBE (A80LPD10X)		31	1-452-032-00	MAGNET, DISC	
12	4-387-204-01	NUT, SPECIAL, CRT		32	2-163-920-01	PLATE, TLH CORRECTION	
13	1-251-756-31	CAP ASSY, HIGH-VOLTAGE		33	1-416-871-11	COIL, LANDING CORRECTION	
14	4-072-365-01	SPACER, DY		34	X-403-633-91	COVER, REAR	
15	\triangle 8-451-499-11	DEFLECTION YOKE (Y34RSA-M)		35	8-453-007-31	NA324-M3	
16	4-065-852-01	SPRING, EXTENSION		36	1-452-896-61	COIL, NA ROTATION (RT-200)	
17	4-067-221-02	CLIP, DGC		37	* X-4036-434-2	ASSY, SUPPORT (H), MASK	
18	* A-1342-518-A	VM2 BOARD MOUNTED		38	4-068-333-01	STAY, SPEAKER	
19	* A-1332-007-A	C BOARD MOUNTED		39	A-1501-439-B	BOX (R) ASSY, SPEAKER	
20	1-416-757-11	COIL, DEMAGNETIC		40	X-4387-214-3	PERMALLOY ASSY, CORRECTION	

6-2. CHASSIS

- : 7-685-648-71 SCREW +BVTP 3 × 12
- : 7-685-663-71 SCREW +BVTP 4 × 16

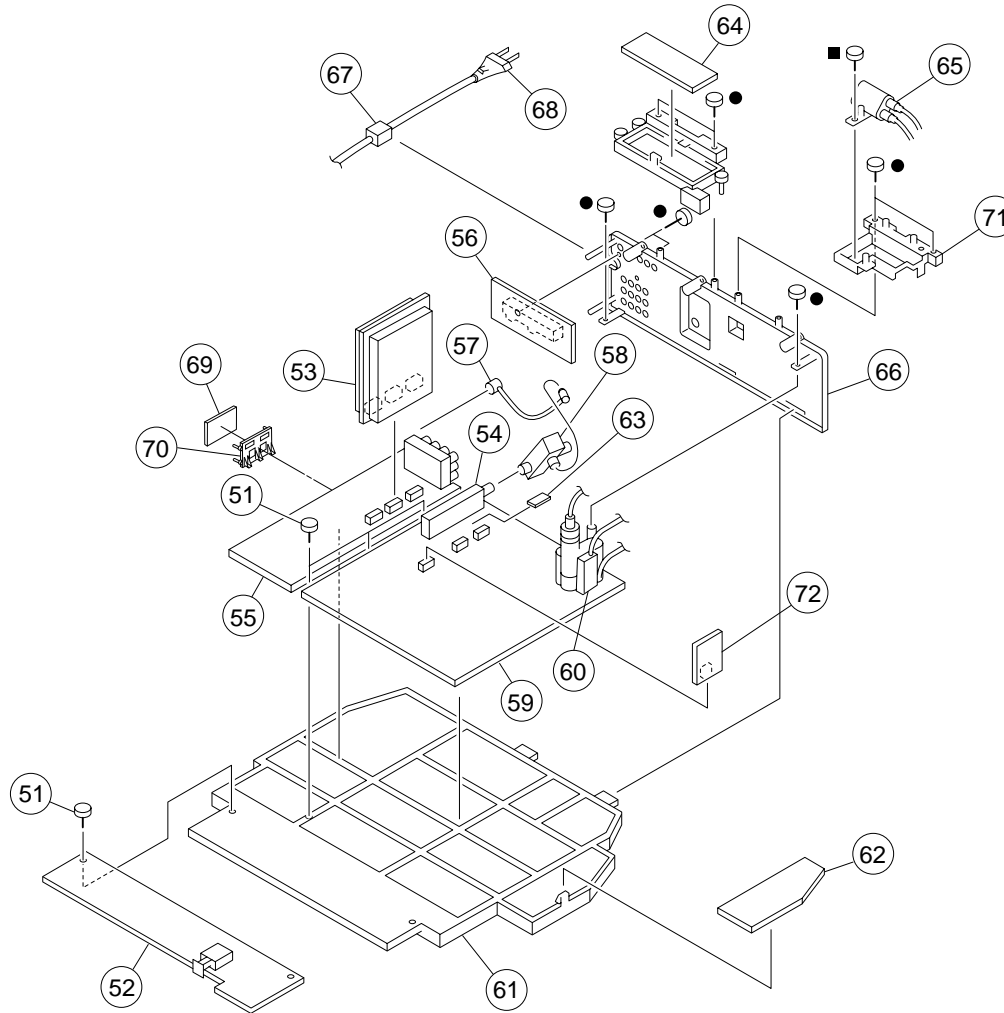

REF. NO.	PART NO.	DESCRIPTION	REMARK	REF. NO.	PART NO.	DESCRIPTION	REMARK
51	4-046-797-01	SCREW +BVTP 3X12		61	* 4-066-681-04	BRACKET, MAIN	
52	* A-1372-739-A	H1 BOARD MOUNTED		62	* A-1343-758-A	D2 BOARD MOUNTED	
53	* A-1195-158-A	P BOARD MOUNTED		63	* A-1131-518-A	B4 BOARD MOUNTED	
54	* 8-598-450-10	TUNER, FSS BTF-LG434		64	* A-1343-759-A	DH BOARD MOUNTED	
55	* A-1136-060-A	B BOARD MOUNTED		65	△ 1-467-525-21	CAP BLOCK, HIGH-VOLTAGE	
56	* A-1388-269-A	J1 BOARD MOUNTED		66	4-066-684-01	BRACKET, TERMINAL	
57	* 1-555-110-00	P-P CABLE		67	4-022-115-00	HOLDER, AC CORD	
58	1-251-658-21	SPLITTER RF		68	△ 1-574-062-11	CORD, POWER (WITH CONNECTOR) 2.5A/250V	
59	* A-1299-075-A	A BOARD MOUNTED		69	* A-1241-405-A	F BOARD MOUNTED	
60	△ 1-453-298-11	TRANSFORMER ASSY, FLAYBACK (NX-4009//M3P)		70	* 4-066-682-01	BRACKET, F PWB	
				71	4-066-680-02	BRACKET, HVC	
				72	8-742-166-00	HYB IC SBX3005-01	

SECTION 7

ELECTRICAL PARTS LIST



NOTE:

The components identified by shading and mark **A** are critical for safety. Replace only with part number specified.

When indicating parts by reference number, please include the board name.

- Items marked "A" are not stocked since they are seldom required for routine service. Some delay should be anticipated when ordering these items.
 - All resistors are in ohms
 - F : nonflammable
 - All variable and adjustable resistors have characteristic curve B, unless otherwise noted.
- CAPACITORS
- MF : μ F, PF : μ MF
- COILS
- MMH : mH, UH : μ H

REF.NO.	PART NO.	DESCRIPTION	REMARK	REF.NO.	PART NO.	DESCRIPTION	REMARK
	* A-1299-075-A	A BOARD COMPLETE *****		C302	1-163-005-11	CERAMIC CHIP 470PF	10% 50V
	4-382-854-11	SCREW (M3X10), P, SW (+)		C304	1-126-967-11	ELECT 47MF	20% 50V
	4-382-854-21	SCREW (M3X14), P, SW (+)		C305	1-107-725-11	CERAMIC CHIP 0.1MF	10% 16V
		<CAPACITOR>		C306	1-163-233-11	CERAMIC CHIP 18PF	5% 50V
C004	1-163-001-11	CERAMIC CHIP 220PF	10% 50V	C307	1-163-233-11	CERAMIC CHIP 18PF	5% 50V
C005	1-163-001-11	CERAMIC CHIP 220PF	10% 50V	C308	1-163-259-91	CERAMIC CHIP 220PF	5% 50V
C006	1-107-725-11	CERAMIC CHIP 0.1MF	10% 16V	C309	1-126-957-11	ELECT 0.22MF	20% 50V
C007	1-126-933-11	ELECT 100MF	20% 16V	C311	1-126-964-11	ELECT 10MF	20% 50V
C013	1-163-021-91	CERAMIC CHIP 0.01MF	10% 50V	C312	1-164-346-11	CERAMIC CHIP 1MF	16V
C014	1-126-967-11	ELECT 47MF	20% 50V	C313	1-164-346-11	CERAMIC CHIP 1MF	16V
C015	1-163-009-11	CERAMIC CHIP 0.001MF	10% 50V	C314	1-164-346-11	CERAMIC CHIP 1MF	16V
C016	1-163-243-11	CERAMIC CHIP 47PF	5% 50V	C315	1-107-725-11	CERAMIC CHIP 0.1MF	10% 16V
C017	1-163-113-00	CERAMIC CHIP 68PF	5% 50V	C316	1-126-935-11	ELECT 470MF	20% 16V
C019	1-104-665-11	ELECT 100MF	20% 25V	C317	1-164-004-11	CERAMIC CHIP 0.1MF	10% 25V
C022	1-163-227-11	CERAMIC CHIP 10PF	0.5PF 50V	C318	1-163-031-11	CERAMIC CHIP 0.01MF	50V
C023	1-163-227-11	CERAMIC CHIP 10PF	0.5PF 50V	C319	1-163-031-11	CERAMIC CHIP 0.01MF	50V
C024	1-163-227-11	CERAMIC CHIP 10PF	0.5PF 50V	C320	1-163-031-11	CERAMIC CHIP 0.01MF	50V
C026	1-107-725-11	CERAMIC CHIP 0.1MF	10% 16V	C322	1-163-005-11	CERAMIC CHIP 470PF	10% 50V
C027	1-107-725-11	CERAMIC CHIP 0.1MF	10% 16V	C323	1-126-933-11	ELECT 100MF	20% 16V
C028	1-163-037-11	CERAMIC CHIP 0.022MF	10% 50V	C324	1-163-017-00	CERAMIC CHIP 0.0047MF	10% 50V
C030	1-126-965-11	ELECT 22MF	20% 50V	C325	1-126-960-11	ELECT 1MF	20% 50V
C031	1-107-725-11	CERAMIC CHIP 0.1MF	10% 16V	C326	1-126-964-11	ELECT 10MF	20% 50V
C032	1-107-823-11	CERAMIC CHIP 0.47MF	10% 16V	C327	1-126-965-11	ELECT 22MF	20% 50V
C034	1-163-031-11	CERAMIC CHIP 0.01MF	50V	C328	1-107-725-11	CERAMIC CHIP 0.1MF	10% 16V
C041	1-163-251-11	CERAMIC CHIP 100PF	5% 50V	C329	1-126-965-11	ELECT 22MF	20% 50V
C042	1-163-251-11	CERAMIC CHIP 100PF	5% 50V	C330	1-107-725-11	CERAMIC CHIP 0.1MF	10% 16V
C043	1-163-251-11	CERAMIC CHIP 100PF	5% 50V	C331	1-126-964-11	ELECT 10MF	20% 50V
C044	1-163-251-11	CERAMIC CHIP 100PF	5% 50V	C332	1-126-963-11	ELECT 4.7MF	20% 50V
C047	1-163-251-11	CERAMIC CHIP 100PF	5% 50V	C335	1-107-725-11	CERAMIC CHIP 0.1MF	10% 16V
C103	1-107-725-11	CERAMIC CHIP 0.1MF	10% 16V	C336	1-107-725-11	CERAMIC CHIP 0.1MF	10% 16V
C104	1-126-933-11	ELECT 100MF	20% 16V	C337	1-126-961-11	ELECT 2.2MF	20% 50V
C107	1-163-005-11	CERAMIC CHIP 470PF	10% 50V	C338	1-163-017-00	CERAMIC CHIP 0.0047MF	10% 50V
C108	1-126-933-11	ELECT 100MF	20% 16V	C341	1-115-340-11	CERAMIC CHIP 0.22MF	10% 25V
C109	1-163-005-11	CERAMIC CHIP 470PF	10% 50V	C342	1-163-259-91	CERAMIC CHIP 220PF	5% 50V
C110	1-163-005-11	CERAMIC CHIP 470PF	10% 50V	C502	1-163-145-00	CERAMIC CHIP 0.0015MF	5% 50V
C111	1-163-005-11	CERAMIC CHIP 470PF	10% 50V	C503	1-126-964-11	ELECT 10MF	20% 50V
C112	1-126-933-11	ELECT 100MF	20% 16V	C504	1-163-007-11	CERAMIC CHIP 680PF	10% 50V
C113	1-126-967-11	ELECT 47MF	20% 50V	C506	1-107-638-11	ELECT 33MF	20% 160V
C114	1-126-967-11	ELECT 47MF	20% 50V	C507	1-102-244-00	CERAMIC 220PF	10% 500V
C115	1-126-967-11	ELECT 47MF	20% 50V	C510	1-102-074-00	CERAMIC 0.001MF	10% 50V
C116	1-107-725-11	CERAMIC CHIP 0.1MF	10% 16V	C513	1-163-021-91	CERAMIC CHIP 0.01MF	10% 50V
C117	1-107-725-11	CERAMIC CHIP 0.1MF	10% 16V	C514	1-106-383-00	MYLAR 0.047MF	10% 200V
C300	1-164-505-11	CERAMIC CHIP 2.2MF	16V	C517	1-164-182-11	CERAMIC CHIP 0.0033MF	10% 50V
C301	1-126-935-11	ELECT 470MF	20% 16V	C518	1-126-933-11	ELECT 100MF	20% 16V
				C519	1-102-212-00	CERAMIC 820PF	10% 500V
				C521	1-104-666-11	ELECT 220MF	20% 25V
				C522	1-126-933-11	ELECT 100MF	20% 16V

The components identified by shading
and mark Δ are critical for safety.
Replace only with part number specified.

A

REF. NO.	PART NO.	DESCRIPTION	REMARK	REF. NO.	PART NO.	DESCRIPTION	REMARK
C523	1-162-318-11	CERAMIC	0.001MF 10% 500V	C617	1-107-792-11	CERAMIC	100PF 5% 1KV
C524	1-126-967-11	ELECT	47MF 20% 50V	C618	1-125-893-11	FILM	680PF 3% 1.5KV
C526	1-130-495-00	MYLAR	0.1MF 5% 50V	C619 Δ	1-119-886-51	CERAMIC	470PF 10% 250V
C527	1-102-820-00	CERAMIC	330PF 5% 50V	C620	1-163-133-00	CERAMIC CHIP	470PF 5% 50V
C528	1-162-116-00	CERAMIC	680PF 10% 2KV	C621	1-102-824-00	CERAMIC	470PF 5% 50V
C530	1-137-372-11	MYLAR	0.022MF 5% 50V	C622	1-102-119-00	CERAMIC	0.0015MF 10% 50V
C531	1-107-903-11	ELECT	2.2MF 20% 50V	C623	1-104-665-11	ELECT	100MF 20% 25V
C532	1-128-528-11	ELECT	470MF 20% 25V	C624	1-125-772-91	CERAMIC	1500PF 10% 2KV
C533	1-128-528-11	ELECT	470MF 20% 25V	C625	1-102-002-00	CERAMIC	680PF 10% 500V
C536	1-136-165-00	MYLAR	0.1MF 5% 50V	C626	1-102-002-00	CERAMIC	680PF 10% 500V
C537	1-107-911-11	ELECT	220MF 20% 50V	C629	1-126-964-11	ELECT	10MF 20% 50V
C538	1-136-544-11	FILM	0.023MF 3% 2KV	C630	1-125-494-11	ELECT(BLOCK)	560MF 20% 160V
C539	1-130-118-00	FILM	0.051MF 5% 400V	C631	1-128-550-11	ELECT	2200MF 20% 50V
C540	1-136-171-00	MYLAR	0.33MF 5% 50V	C632	1-126-936-11	ELECT	3300MF 20% 16V
C543	1-162-116-00	CERAMIC	680PF 10% 2KV	C633	1-104-999-11	MYLAR	0.1MF 10% 200V
C546	1-163-017-00	CERAMIC CHIP	0.0047MF 10% 50V	C634	1-126-934-11	ELECT	220MF 20% 16V
C550	1-106-220-00	MYLAR	0.1MF 10% 100V	C635	1-104-665-11	ELECT	100MF 20% 10V
C551	1-126-960-11	ELECT	1MF 20% 50V	C636	1-104-760-11	CERAMIC CHIP	0.047MF 10% 50V
C552	1-162-116-00	CERAMIC	680PF 10% 2KV	C638	1-161-830-00	CERAMIC	0.0047MF 500V
C553	1-162-116-00	CERAMIC	680PF 10% 2KV	C641	1-102-002-00	CERAMIC	680PF 10% 500V
C554	1-106-361-00	MYLAR	0.0056MF 10% 100V	C642	1-107-890-11	ELECT	2200MF 20% 25V
C556	1-128-528-11	ELECT	470MF 20% 25V	C643	1-126-933-11	ELECT	100MF 20% 16V
C557	1-126-941-11	ELECT	470MF 20% 25V	C644	1-104-331-11	CERAMIC	0.0022MF 10% 1KV
C558	1-123-024-21	ELECT	33MF 160V	C645	1-137-605-11	MYLAR	0.01MF 10% 250V
C560	1-102-228-00	CERAMIC	470PF 10% 500V	C646	1-107-679-91	ELECT	10MF 20% 450V
C561	1-129-928-00	FILM	0.0027MF 5% 630V	C647	1-163-275-11	CERAMIC CHIP	0.001MF 5% 50V
C562	1-102-228-00	CERAMIC	470PF 10% 500V	C649	1-126-940-11	ELECT	330MF 20% 25V
C563	1-163-021-91	CERAMIC CHIP	0.01MF 10% 50V	C650	1-163-275-11	CERAMIC CHIP	0.001MF 5% 50V
C564	1-163-038-91	CERAMIC CHIP	0.1MF 25V	C651	1-163-133-00	CERAMIC CHIP	470PF 5% 50V
C565	1-107-655-11	ELECT	47MF 20% 250V	C652	1-126-965-11	ELECT	22MF 20% 50V
C566	1-102-244-00	CERAMIC	220PF 10% 500V	C653	1-126-967-11	ELECT	47MF 20% 50V
C567	1-109-961-11	FILM	0.75MF 5% 250V	C655	1-119-886-51	CERAMIC	470PF 10% 250V
C568	1-102-228-00	CERAMIC	470PF 10% 500V	C657	1-101-821-00	CERAMIC	0.0022MF 500V
C570	1-117-674-71	FILM	1.8MF 5% 250V	C912	1-107-725-11	CERAMIC CHIP	0.1MF 10% 16V
C572	1-115-514-11	FILM	0.22MF 5% 250V	C913	1-126-933-11	ELECT	100MF 20% 16V
C573	1-106-387-00	MYLAR	0.068MF 10% 200V			<CONNECTOR>	
C574	1-104-709-11	ELECT	4.7MF 0 160V	CN101 *	1-779-890-11	CONNECTOR, BOARD TO BOARD 10P	
C576	1-130-495-00	MYLAR	0.1MF 5% 50V	CN102 *	1-779-889-11	CONNECTOR, BOARD TO BOARD 8P	
C577	1-115-516-11	FILM	0.33MF 5% 250V	CN104	1-695-915-11	TAB (CONTACT)	
C586	1-216-295-91	SHORT	0	CN105 *	1-508-784-21	PIN, CONNECTOR (5MM PITCH) 1P	
C600 Δ	1-104-705-11	MYLAR	0.1MF 20% 250V	CN106 *	1-564-506-11	PLUG, CONNECTOR 3P	
C601	1-130-338-91	FILM	0.01MF 5% 630V	CN201 *	1-564-506-11	PLUG, CONNECTOR 3P	
C602 Δ	1-104-705-11	MYLAR	0.1MF 20% 250V	CN202 *	1-508-847-00	PIN, CONNECTOR 4P	
C603	1-126-967-11	ELECT	47MF 20% 50V	CN302 *	1-779-889-11	CONNECTOR, BOARD TO BOARD 8P	
C604	1-163-009-11	CERAMIC CHIP	0.001MF 10% 50V	CN303 *	1-779-890-11	CONNECTOR, BOARD TO BOARD 10P	
C605 Δ	1-119-886-51	CERAMIC	470PF 10% 250V	CN304 *	1-766-955-11	CONNECTOR, BOARD TO BOARD 11P	
C606 Δ	1-119-886-51	CERAMIC	470PF 10% 250V	CN501 *	1-508-784-21	PIN, CONNECTOR (5MM PITCH) 1P	
C607	1-161-830-00	CERAMIC	0.0047MF 99% 500V	CN503 *	1-564-510-11	PLUG, CONNECTOR 7P	
C608	1-161-830-00	CERAMIC	0.0047MF 99% 500V	CN504	1-695-915-11	TAB (CONTACT)	
C609	1-126-968-11	ELECT	100MF 20% 50V	CN505* Δ	1-508-766-00	PIN, CONNECTOR (5MM PITCH) 4P	
C610	1-126-964-11	ELECT	10MF 20% 50V	CN508	1-695-915-11	TAB (CONTACT)	
C611	1-161-830-00	CERAMIC	0.0047MF 99% 500V	CN510 *	1-564-507-11	PLUG, CONNECTOR 4P	
C612	1-161-830-00	CERAMIC	0.0047MF 99% 500V	CN601* Δ	1-580-843-11	PIN, CONNECTOR (POWER)	
C613	1-125-906-11	ELECT	560MF 20% 450V	CN602* Δ	1-508-786-00	PIN, CONNECTOR (5MM PITCH) 2P	
C614	1-126-964-11	ELECT	10MF 20% 50V	CN603 *	1-508-784-21	PIN, CONNECTOR (5MM PITCH) 1P	
C615 Δ	1-119-886-51	CERAMIC	470PF 10% 250V	CN604 *	1-573-963-11	PIN, CONNECTOR (PC BOARD) 3P	
C616	1-130-202-00	FILM	0.022MF 5% 400V				

The components identified by shading and mark Δ are critical for safety. Replace only with part number specified.

A

REF. NO.	PART NO.	DESCRIPTION	REMARK	REF. NO.	PART NO.	DESCRIPTION	REMARK
CN605*	Δ 1-564-507-11	PLUG, CONNECTOR 4P		D607	8-719-073-01	DIODE MA111-(K8).S0	
CN607	* 1-508-784-21	PIN, CONNECTOR (5MM PITCH) 1P		D608	8-719-110-53	DIODE RD20ESB2	
CN904	* 1-564-512-11	PLUG, CONNECTOR 9P		D609	8-719-311-31	DIODE RU-1P	
		<DIODE>		D610	8-719-043-76	DIODE AK04V0	
D001	8-719-073-01	DIODE MA111-(K8).S0		D611	8-719-046-74	DIODE AU-01Z-V1	
D002	8-719-073-01	DIODE MA111-(K8).S0		D612	8-719-071-38	DIODE D5S6M	
D003	8-719-073-01	DIODE MA111-(K8).S0		D613	8-719-046-74	DIODE AU-01Z-V1	
D004	8-719-073-01	DIODE MA111-(K8).S0		D614	8-719-046-74	DIODE AU-01Z-V1	
D005	8-719-073-01	DIODE MA111-(K8).S0		D620	8-719-110-72	DIODE RD30ESB2	
D006	1-216-295-91	SHORT 0		D621	8-719-071-38	DIODE D5S6M	
D300	8-719-073-01	DIODE MA111-(K8).S0		D622	8-719-071-39	DIODE FMU-G26S	
D301	8-719-073-01	DIODE MA111-(K8).S0		D623	8-719-158-57	DIODE RD15SB2	
D303	8-719-073-01	DIODE MA111-(K8).S0		D624	8-719-073-01	DIODE MA111-(K8).S0	
D304	8-719-073-01	DIODE MA111-(K8).S0		D625	8-719-158-39	DIODE RD10SB	
D305	8-719-073-01	DIODE MA111-(K8).S0		D628	8-719-911-19	DIODE ISS119-25	
D306	8-719-073-01	DIODE MA111-(K8).S0		D630	8-719-052-74	DIODE FMX-12S	
D307	8-719-073-01	DIODE MA111-(K8).S0		D631	8-719-068-00	DIODE ERC04-06SE	
D308	8-719-073-01	DIODE MA111-(K8).S0		D632	8-719-068-00	DIODE ERC04-06SE	
D309	8-719-069-54	DIODE UDZS-TE17-5.1B		D633	8-719-948-45	DIODE ERA22-08	
D311	8-719-073-01	DIODE MA111-(K8).S0		D634	8-719-073-01	DIODE MA111-(K8).S0	
D312	8-719-073-01	DIODE MA111-(K8).S0		D635	8-719-073-01	DIODE MA111-(K8).S0	
D313	8-719-073-01	DIODE MA111-(K8).S0		D636	8-719-510-02	DIODE D1NS4	
D315	8-719-988-61	DIODE ISS355TE-17		D637	8-719-109-96	DIODE RD6.8ESB1	
D316	8-719-158-39	DIODE RD10SB		D638	8-719-510-48	DIODE D1N20R	
D317	8-719-073-01	DIODE MA111-(K8).S0				<CONNECTOR>	
D320	8-719-069-60	DIODE UDZS-TE17-9.1B		DY1	* Δ 1-580-798-11	CONNECTOR PIN (DY) 6P	
D321	8-719-069-60	DIODE UDZS-TE17-9.1B				<FERRITE BEAD>	
D504	8-719-302-43	DIODE EL1Z		FB101	1-216-295-91	SHORT 0	
D505	8-719-073-01	DIODE MA111-(K8).S0		FB102	1-216-295-91	SHORT 0	
D506	8-719-911-19	DIODE ISS119-25		FB501	1-410-397-21	FERRITE 1.1UH	
D507	8-719-073-01	DIODE MA111-(K8).S0		FB502	1-410-397-21	FERRITE 1.1UH	
D508	8-719-073-01	DIODE MA111-(K8).S0		FB600	1-410-396-41	FERRITE 0.45UH	
D509	8-719-158-15	DIODE RD5.6SB		FB601	1-410-397-21	FERRITE 1.1UH	
D510	8-719-073-01	DIODE MA111-(K8).S0		FB602	1-410-397-21	FERRITE 1.1UH	
D511	8-719-073-01	DIODE MA111-(K8).S0		FB603	1-412-911-11	FERRITE 0UH	
D512	8-719-073-01	DIODE MA111-(K8).S0		FB604	1-412-911-31	FERRITE 0UH	
D513	8-719-908-03	DIODE GP08D		FB605	1-412-911-31	FERRITE 0UH	
D517	8-719-061-21	DIODE FMQ-G5FMS		FB606	1-412-911-31	FERRITE 0UH	
D520	8-719-073-01	DIODE MA111-(K8).S0		FB608	1-412-911-31	FERRITE 0UH	
D521	8-719-302-43	DIODE EL1Z		FB611	1-410-397-21	FERRITE 1.1UH	
D522	8-719-028-45	DIODE D2L20U		FB612	1-410-397-21	FERRITE 1.1UH	
D523	8-719-302-43	DIODE EL1Z		FB613	1-410-397-21	FERRITE 1.1UH	
D525	8-719-911-19	DIODE ISS119-25		FB615	1-410-397-21	FERRITE 1.1UH	
D527	8-719-908-03	DIODE GP08D				<IC>	
D530	8-719-071-39	DIODE FMU-G26S		IC001	8-752-904-53	IC CXP750097-006S	
D531	8-719-073-01	DIODE MA111-(K8).S0		IC002	8-759-371-21	IC MM1319AFBE	
D532	8-719-073-01	DIODE MA111-(K8).S0		IC003	8-759-527-71	IC M24C08-BN6	
D534	1-216-295-91	SHORT 0		IC301	8-752-090-41	IC CXA2139S	
D600	8-719-911-19	DIODE ISS119-25		IC502	8-759-700-07	IC NJM2903M	
D602	8-719-911-19	DIODE ISS119-25		IC503	8-759-980-58	IC TDA8172	
D603	8-719-150-92	DIODE RD33EB3T		IC601	8-749-014-48	IC STR-F6656	
D604	8-719-028-72	DIODE RGP02-17EL-6433					
D605	8-719-510-53	DIODE D4SB60L					
D606	8-719-108-18	THYRISTOR 5P6M					

The components identified by shading
and mark \triangle are critical for safety.
Replace only with part number specified.

A

REF. NO.	PART NO.	DESCRIPTION	REMARK	REF. NO.	PART NO.	DESCRIPTION	REMARK
IC602	8-749-920-61	IC SE-135N		L513	1-412-549-11	INDUCTOR 1MMH	
IC603	8-759-701-59	IC NJM78M09FA		L515	1-459-104-00	COIL, WITH CORE	
IC604	8-759-231-53	IC TA7805S		L518	1-408-611-31	INDUCTOR 47UH	
		<CHIP CONDUCTOR>		L601	1-412-527-11	INDUCTOR 15UH	
JR001	1-216-295-91	SHORT 0		L905	1-414-856-11	INDUCTOR 10UH	
JR002	1-216-295-91	SHORT 0				<PHOTO COUPLER>	
JR003	1-216-295-91	SHORT 0		PH600 \triangle	8-749-924-35	PHOTO COUPLER ON3171-R	
JR004	1-216-295-91	SHORT 0				<TRANSISTOR>	
JR005	1-216-295-91	SHORT 0		Q001	8-729-216-22	TRANSISTOR 2SA1162-G	
JR006	1-216-295-91	SHORT 0		Q002	8-729-230-49	TRANSISTOR 2SC2712-YG	
JR007	1-216-295-91	SHORT 0		Q003	8-729-027-23	TRANSISTOR DTA114EKA-T146	
JR008	1-216-295-91	SHORT 0		Q004	8-729-421-22	TRANSISTOR UN2211	
JR009	1-216-295-91	SHORT 0		Q101	8-729-230-49	TRANSISTOR 2SC2712-YG	
JR010	1-216-295-91	SHORT 0		Q301	8-729-216-22	TRANSISTOR 2SA1162-G	
JR011	1-216-295-91	SHORT 0		Q304	8-729-216-22	TRANSISTOR 2SA1162-G	
JR012	1-216-295-91	SHORT 0		Q305	8-729-216-22	TRANSISTOR 2SA1162-G	
JR013	1-216-295-91	SHORT 0		Q306	8-729-216-22	TRANSISTOR 2SA1162-G	
JR014	1-216-295-91	SHORT 0		Q307	8-729-230-49	TRANSISTOR 2SC2712-YG	
JR015	1-216-295-91	SHORT 0		Q308	8-729-216-22	TRANSISTOR 2SA1162-G	
JR016	1-216-295-91	SHORT 0		Q311	8-729-230-49	TRANSISTOR 2SC2712-YG	
JR018	1-216-295-91	SHORT 0		Q312	8-729-026-49	TRANSISTOR 2SA1037AK-T146-R	
JR019	1-216-295-91	SHORT 0		Q313	8-729-230-49	TRANSISTOR 2SC2712-YG	
JR102	1-216-295-91	SHORT 0		Q315	8-729-421-22	TRANSISTOR UN2211	
JR109	1-216-295-91	SHORT 0		Q501	8-729-216-22	TRANSISTOR 2SA1162-G	
JR301	1-216-295-91	SHORT 0		Q502	8-729-216-22	TRANSISTOR 2SA1162-G	
JR303	1-216-295-91	SHORT 0		Q503	8-729-230-49	TRANSISTOR 2SC2712-YG	
JR500	1-216-295-91	SHORT 0		Q505	8-729-931-45	TRANSISTOR IRF614	
JR501	1-216-295-91	SHORT 0		Q506	8-729-119-80	TRANSISTOR 2SC2688-LK	
JR502	1-216-295-91	SHORT 0		Q507	8-729-216-22	TRANSISTOR 2SA1162-G	
JR503	1-216-295-91	SHORT 0		Q509	8-729-230-49	TRANSISTOR 2SC2712-YG	
JR600	1-216-295-91	SHORT 0		Q511	8-729-016-32	TRANSISTOR 2SC4927-01	
		<COIL>		Q600	8-729-119-78	TRANSISTOR 2SC2785-HFE	
L002	1-414-856-11	INDUCTOR 10UH		Q601	8-729-023-22	TRANSISTOR 2SD2114K	
L003	1-414-180-11	INDUCTOR 3.3UH		Q602	8-729-230-49	TRANSISTOR 2SC2712-YG	
L005	1-414-233-22	INDUCTOR CHIP 0UH		Q603	8-729-027-23	TRANSISTOR DTA114EKA-T146	
L101	1-414-856-11	INDUCTOR 10UH		Q604	8-729-200-17	TRANSISTOR 2SA1091-O	
L102	1-414-856-11	INDUCTOR 10UH		Q605	8-729-044-30	TRANSISTOR 2SK2845-LB102	
L103	1-414-856-11	INDUCTOR 10UH		Q606	8-729-230-49	TRANSISTOR 2SC2712-YG	
L104	1-414-856-11	INDUCTOR 10UH		Q607	8-729-922-37	TRANSISTOR 2SD2144S-UVW	
L105	1-414-856-11	INDUCTOR 10UH		Q608	8-729-230-49	TRANSISTOR 2SC2712-YG	
L301	1-414-189-31	INDUCTOR 100UH				<RESISTOR>	
L302	1-414-185-41	INDUCTOR 22UH		R001	1-414-233-22	INDUCTOR CHIP 0UH	
L501	1-412-525-31	INDUCTOR 10UH		R002	1-216-025-91	RES,CHIP 100 5% 1/10W	
L502	1-422-613-11	COIL, AIR CORE		R003	1-216-073-00	RES,CHIP 10K 5% 1/10W	
L503	1-412-525-31	INDUCTOR 10UH		R004	1-216-025-91	RES,CHIP 100 5% 1/10W	
L504	1-412-525-31	INDUCTOR 10UH		R005	1-216-025-91	RES,CHIP 100 5% 1/10W	
L505	1-412-525-31	INDUCTOR 10UH		R007	1-216-049-91	RES,CHIP 1K 5% 1/10W	
L506	1-412-525-31	INDUCTOR 10UH		R008	1-216-065-91	RES,CHIP 4.7K 5% 1/10W	
L507	1-459-111-00	INDUCTOR 10MMH		R009	1-216-065-91	RES,CHIP 4.7K 5% 1/10W	
L508	1-412-525-31	INDUCTOR 10UH		R010	1-216-065-91	RES,CHIP 4.7K 5% 1/10W	
L511	1-406-977-21	INDUCTOR 100UH		R011	1-216-065-91	RES,CHIP 4.7K 5% 1/10W	
L512	1-412-549-11	INDUCTOR 1MMH					

A

REF. NO.	PART NO.	DESCRIPTION	REMARK	REF. NO.	PART NO.	DESCRIPTION	REMARK
R012	1-216-065-91	RES,CHIP	4.7K 5% 1/10W	R303	1-216-089-91	RES,CHIP	47K 5% 1/10W
R013	1-216-065-91	RES,CHIP	4.7K 5% 1/10W	R304	1-216-073-00	RES,CHIP	10K 5% 1/10W
R014	1-216-025-91	RES,CHIP	100 5% 1/10W	R306	1-216-085-00	RES,CHIP	33K 5% 1/10W
R015	1-216-025-91	RES,CHIP	100 5% 1/10W	R308	1-216-025-91	RES,CHIP	100 5% 1/10W
R017	1-216-049-91	RES,CHIP	1K 5% 1/10W	R309	1-216-025-91	RES,CHIP	100 5% 1/10W
R018	1-216-033-00	RES,CHIP	220 5% 1/10W	R310	1-216-025-91	RES,CHIP	100 5% 1/10W
R019	1-216-073-00	RES,CHIP	10K 5% 1/10W	R315	1-216-053-00	RES,CHIP	1.5K 5% 1/10W
R021	1-216-073-00	RES,CHIP	10K 5% 1/10W	R316	1-216-053-00	RES,CHIP	1.5K 5% 1/10W
R022	1-216-025-91	RES,CHIP	100 5% 1/10W	R318	1-216-053-00	RES,CHIP	1.5K 5% 1/10W
R023	1-216-049-91	RES,CHIP	1K 5% 1/10W	R319	1-216-025-91	RES,CHIP	100 5% 1/10W
R024	1-216-063-91	RES,CHIP	3.9K 5% 1/10W	R320	1-216-065-91	RES,CHIP	4.7K 5% 1/10W
R025	1-216-063-91	RES,CHIP	3.9K 5% 1/10W	R321	1-216-073-00	RES,CHIP	10K 5% 1/10W
R026	1-216-063-91	RES,CHIP	3.9K 5% 1/10W	R322	1-216-033-00	RES,CHIP	220 5% 1/10W
R027	1-216-049-91	RES,CHIP	1K 5% 1/10W	R326	1-216-029-00	RES,CHIP	150 5% 1/10W
R029	1-216-049-91	RES,CHIP	1K 5% 1/10W	R327	1-216-033-00	RES,CHIP	220 5% 1/10W
R031	1-216-049-91	RES,CHIP	1K 5% 1/10W	R328	1-216-065-91	RES,CHIP	4.7K 5% 1/10W
R032	1-216-025-91	RES,CHIP	100 5% 1/10W	R329	1-216-041-00	RES,CHIP	470 5% 1/10W
R034	1-216-049-91	RES,CHIP	1K 5% 1/10W	R331	1-216-295-91	SHORT	0 5% 1/10W
R035	1-216-025-91	RES,CHIP	100 5% 1/10W	R332	1-216-033-00	RES,CHIP	220 5% 1/10W
R036	1-216-025-91	RES,CHIP	100 5% 1/10W	R333	1-216-083-00	RES,CHIP	27K 5% 1/10W
R037	1-216-025-91	RES,CHIP	100 5% 1/10W	R334	1-208-291-11	RES,CHIP	4.7M 5% 1/10W
R038	1-216-049-91	RES,CHIP	1K 5% 1/10W	R335	1-216-045-00	RES,CHIP	680 5% 1/10W
R039	1-216-049-91	RES,CHIP	1K 5% 1/10W	R338	1-216-037-00	RES,CHIP	330 5% 1/10W
R040	1-216-025-91	RES,CHIP	100 5% 1/10W	R339	1-216-033-00	RES,CHIP	220 5% 1/10W
R041	1-216-025-91	RES,CHIP	100 5% 1/10W	R340	1-216-025-91	RES,CHIP	100 5% 1/10W
R042	1-216-295-91	SHORT	0 5% 1/10W	R345	1-216-073-00	RES,CHIP	10K 5% 1/10W
R043	1-216-049-91	RES,CHIP	1K 5% 1/10W	R348	1-208-806-11	METAL CHIP	10K 0.50% 1/10W
R044	1-216-025-91	RES,CHIP	100 5% 1/10W	R349	1-216-073-00	RES,CHIP	10K 5% 1/10W
R045	1-414-233-22	INDUCTOR CHIP	0UH 5% 1/10W	R350	1-216-057-00	RES,CHIP	2.2K 5% 1/10W
R046	1-216-049-91	RES,CHIP	1K 5% 1/10W	R351	1-216-049-91	RES,CHIP	1K 5% 1/10W
R047	1-414-233-22	INDUCTOR CHIP	0UH 5% 1/10W	R357	1-216-079-00	RES,CHIP	18K 5% 1/10W
R048	1-216-073-00	RES,CHIP	10K 5% 1/10W	R358	1-216-049-91	RES,CHIP	1K 5% 1/10W
R050	1-216-073-00	RES,CHIP	10K 5% 1/10W	R359	1-216-033-00	RES,CHIP	220 5% 1/10W
R052	1-216-053-00	RES,CHIP	1.5K 5% 1/10W	R360	1-216-033-00	RES,CHIP	220 5% 1/10W
R053	1-216-049-91	RES,CHIP	1K 5% 1/10W	R361	1-216-073-00	RES,CHIP	10K 5% 1/10W
R054	1-216-049-91	RES,CHIP	1K 5% 1/10W	R362	1-216-075-00	RES,CHIP	12K 5% 1/10W
R055	1-216-073-00	RES,CHIP	10K 5% 1/10W	R363	1-216-079-00	RES,CHIP	18K 5% 1/10W
R056	1-216-073-00	RES,CHIP	10K 5% 1/10W	R364	1-216-295-91	SHORT	0 5% 1/10W
R061	1-216-295-91	SHORT	0 5% 1/10W	R365	1-216-033-00	RES,CHIP	220 5% 1/10W
R062	1-216-041-00	RES,CHIP	470 5% 1/10W	R366	1-216-073-00	RES,CHIP	10K 5% 1/10W
R063	1-216-041-00	RES,CHIP	470 5% 1/10W	R367	1-216-073-00	RES,CHIP	10K 5% 1/10W
R064	1-216-041-00	RES,CHIP	470 5% 1/10W	R368	1-216-073-00	RES,CHIP	10K 5% 1/10W
R065	1-216-041-00	RES,CHIP	470 5% 1/10W	R370	1-216-033-00	RES,CHIP	220 5% 1/10W
R066	1-216-049-91	RES,CHIP	1K 5% 1/10W	R376	1-216-081-00	RES,CHIP	22K 5% 1/10W
R067	1-216-049-91	RES,CHIP	1K 5% 1/10W	R377	1-216-121-91	RES,CHIP	1M 5% 1/10W
R105	1-216-295-91	SHORT	0 5% 1/10W	R378	1-216-295-91	SHORT	0 5% 1/10W
R109	1-216-041-00	RES,CHIP	470 5% 1/10W	R500	1-249-417-11	CARBON	1K 5% 1/4W
R111	1-216-025-91	RES,CHIP	100 5% 1/10W	R501	1-216-049-91	RES,CHIP	1K 5% 1/10W
R112	1-216-025-91	RES,CHIP	100 5% 1/10W	R505	1-216-113-00	RES,CHIP	470K 5% 1/10W
R113	1-216-025-91	RES,CHIP	100 5% 1/10W	R506	1-216-079-00	RES,CHIP	18K 5% 1/10W
R225	1-216-033-00	RES,CHIP	220 5% 1/10W	R507	1-249-389-11	CARBON	4.7 5% 1/4W F
R226	1-216-033-00	RES,CHIP	220 5% 1/10W	R508	1-215-909-11	METAL OXIDE	47 5% 3W F
R227	1-216-033-00	RES,CHIP	220 5% 1/10W	R509	1-216-474-11	METAL OXIDE	82 5% 3W F
R237	1-216-295-91	SHORT	0 5% 1W F	R510	1-216-424-11	METAL OXIDE	39 5% 1W F
R301	1-216-113-00	RES,CHIP	470K 5% 1/10W	R511	1-216-399-00	METAL OXIDE	6.8 5% 3W F
R302	1-216-089-91	RES,CHIP	47K 5% 1/10W	R515	1-216-349-00	METAL OXIDE	1 5% 1W F
				R517	1-208-798-11	METAL CHIP	4.7K 0.50% 1/10W

The components identified by shading
and mark Δ are critical for safety.
Replace only with part number specified.

A

REF. NO.	PART NO.	DESCRIPTION		REMARK	REF. NO.	PART NO.	DESCRIPTION		REMARK
R518	1-247-807-31	CARBON	100	5% 1/4W	R589	1-215-886-11	METAL OXIDE	100	5% 2W F
R519	1-216-469-11	METAL OXIDE	12	5% 3W F	R590	1-215-465-00	METAL	68K	1% 1/4W
R520	1-215-445-00	METAL	10K	1% 1/4W	R591	1-260-288-11	CARBON	0.47	5% 1/2W F
R522	1-208-806-11	METAL CHIP	10K	0.50% 1/10W	R592	1-208-830-11	METAL CHIP	100K	0.50% 1/10W
R523	1-249-411-11	CARBON	330	5% 1/4W	R593	1-260-288-11	CARBON	0.47	5% 1/2W F
R525	1-208-854-11	METAL CHIP	1M	0.50% 1/10W	R594	1-260-288-11	CARBON	0.47	5% 1/2W F
R526	1-208-803-11	METAL CHIP	7.5K	0.50% 1/10W	R596	1-216-480-11	METAL OXIDE	820	5% 3W F
R527	1-216-001-00	RES,CHIP	10	5% 1/10W	R597	1-247-750-11	CARBON	680	5% 1/2W F
R528	1-208-814-91	METAL CHIP	22K	0.50% 1/10W	R598	1-249-438-11	CARBON	56K	5% 1/4W
R529	1-208-766-11	METAL CHIP	220	0.50% 1/10W	R600	1-249-438-11	CARBON	56K	5% 1/4W
R531	1-247-843-11	CARBON	3.3K	5% 1/4W	R601	1-249-417-11	CARBON	1K	5% 1/4W F
R532	1-216-073-00	RES,CHIP	10K	5% 1/10W	R602	1-249-389-11	CARBON	4.7	5% 1/4W F
R533	1-249-417-11	CARBON	1K	5% 1/4W	R603	1-215-485-00	METAL	470K	1% 1/4W
R534	1-216-364-11	METAL OXIDE	0.39	5% 2W F	R604	1-216-097-91	RES,CHIP	100K	5% 1/10W
R535	1-216-067-00	RES,CHIP	5.6K	5% 1/10W	R607	1-249-425-11	CARBON	4.7K	5% 1/4W
R536	1-216-067-00	RES,CHIP	5.6K	5% 1/10W	R608	1-240-205-91	CARBON	22M	5% 1/2W
R537	1-208-804-11	METAL CHIP	8.2K	0.50% 1/10W	R609	1-216-057-00	RES,CHIP	2.2K	5% 1/10W
R539	1-216-049-91	RES,CHIP	1K	5% 1/10W	R610	1-216-073-00	RES,CHIP	10K	5% 1/10W
R540	1-216-065-91	RES,CHIP	4.7K	5% 1/10W	R611	1-216-089-91	RES,CHIP	47K	5% 1/10W
R541	1-216-065-91	RES,CHIP	4.7K	5% 1/10W	R612	1-216-045-00	RES,CHIP	680	5% 1/10W
R542	1-216-097-91	RES,CHIP	100K	5% 1/10W	R614	1-216-041-00	RES,CHIP	470	5% 1/10W
R543	1-216-437-00	METAL OXIDE	5.6K	5% 1W F	R615	1-216-366-00	METAL OXIDE	0.56	5% 2W F
R544	1-216-480-11	METAL OXIDE	820	5% 3W F	R616	1-260-302-51	CARBON	6.8	5% 1/2W F
R545	1-216-077-91	RES,CHIP	15K	5% 1/10W	R617	1-247-791-91	CARBON	22	5% 1/4W
R546	1-216-077-91	RES,CHIP	15K	5% 1/10W	R619	1-260-128-11	CARBON	270K	5% 1/2W
R547	1-216-085-00	RES,CHIP	33K	5% 1/10W	R621	1-215-859-00	METAL OXIDE	22	5% 1W F
R548	1-208-796-11	METAL CHIP	3.9K	0.50% 1/10W	R623	1-216-095-00	RES,CHIP	82K	5% 1/10W
R549	1-215-451-00	METAL	18K	1% 1/4W	R624	1-216-089-91	RES,CHIP	47K	5% 1/10W
R550	1-216-097-91	RES,CHIP	100K	5% 1/10W	R626	1-216-049-91	RES,CHIP	1K	5% 1/10W
R551	1-249-421-11	CARBON	2.2K	5% 1/4W	R627	1-240-251-11	CMT,MELF	6.8	5% 10W
R552	1-216-057-00	RES,CHIP	2.2K	5% 1/10W	R629	1-247-747-11	CARBON	470	5% 1/2W F
R553	1-215-453-00	METAL	22K	1% 1/4W	R630	1-249-429-11	CARBON	10K	5% 1/4W F
R554	1-215-453-00	METAL	22K	1% 1/4W	R631	1-216-089-91	RES,CHIP	47K	5% 1/10W
R556	1-215-437-00	METAL	4.7K	1% 1/4W	R632	1-220-886-11	FUSIBLE	0.1	10% 1W F
R557	1-216-361-00	METAL OXIDE	0.22	5% 2W F	R634	Δ 1-218-265-11	METAL	8.2M	5% 1W
R558	1-247-843-11	CARBON	3.3K	5% 1/4W	R635	1-216-492-11	METAL OXIDE	82K	5% 3W F
R559	1-249-429-11	CARBON	10K	5% 1/4W	R636	1-215-924-00	METAL OXIDE	15K	5% 3W F
R560	1-216-073-00	RES,CHIP	10K	5% 1/10W	R637	1-216-492-11	METAL OXIDE	82K	5% 3W F
R561	1-216-049-91	RES,CHIP	1K	5% 1/10W	R639	1-216-361-00	METAL OXIDE	0.22	5% 2W F
R562	1-249-401-11	CARBON	47	5% 1/4W	R640	1-249-415-11	CARBON	680	5% 1/4W
R564	1-208-822-11	METAL CHIP	47K	0.50% 1/10W	R641	1-216-361-00	METAL OXIDE	0.22	5% 2W F
R565	1-216-061-00	RES,CHIP	3.3K	5% 1/10W	R642	1-249-419-11	CARBON	1.5K	5% 1/4W
R568	1-249-383-11	CARBON	1.5	5% 1/4W F	R643	1-247-843-11	CARBON	3.3K	5% 1/4W
R570	1-216-069-00	RES,CHIP	6.8K	5% 1/10W	R644	1-249-419-11	CARBON	1.5K	5% 1/4W
R571	1-215-442-00	METAL	7.5K	1% 1/4W	R646	1-215-924-00	METAL OXIDE	15K	5% 3W F
R575	1-208-796-11	METAL CHIP	3.9K	0.50% 1/10W	R647	1-249-387-11	CARBON	3.3	5% 1/4W
R577	1-215-913-11	METAL OXIDE	220	5% 3W F	R648	1-216-057-00	RES,CHIP	2.2K	5% 1/10W
R578	1-216-369-00	METAL OXIDE	1	5% 2W F	R649	1-249-417-11	CARBON	1K	5% 1/4W
R579	1-216-295-91	SHORT	0		R650	1-215-882-00	METAL OXIDE	22	5% 2W F
R580	1-208-830-11	METAL CHIP	100K	0.50% 1/10W	R652	1-215-900-11	METAL OXIDE	22K	5% 2W F
R581	1-208-798-11	METAL CHIP	4.7K	0.50% 1/10W	R653	1-215-873-00	METAL OXIDE	4.7K	5% 1W F
R582	1-216-295-91	SHORT	0		R654	1-216-369-00	METAL OXIDE	1	5% 2W F
R583	1-216-125-00	RES,CHIP	1.5M	5% 1/10W	R656	1-249-417-11	CARBON	1K	5% 1/4W
R584	1-216-065-91	RES,CHIP	4.7K	5% 1/10W	R657	1-260-127-11	CARBON	220K	5% 1/2W
R585	1-249-381-11	CARBON	1	5% 1/4W	R659	1-216-049-91	RES,CHIP	1K	5% 1/10W
R587	1-208-849-11	METAL CHIP	620K	0.50% 1/10W					
R588	1-215-911-11	METAL OXIDE	100	5% 3W F					

The components identified by shading and mark Δ are critical for safety. Replace only with part number specified.

A **B**

REF. NO.	PART NO.	DESCRIPTION	REMARK
R660	1-216-073-00	RES,CHIP 10K	5% 1/10W
R661	1-215-873-00	METAL OXIDE 4.7K	5% 1W F
R909	1-216-065-91	RES,CHIP 4.7K	5% 1/10W
R910	1-216-065-91	RES,CHIP 4.7K	5% 1/10W
<RELAY>			
RY600 Δ	1-755-276-21	RELAY, POWER	
RY601 Δ	1-755-299-11	RELAY	
<SWITCH>			
S501	1-572-707-11	SWITCH, LEVER	
S502	1-572-707-11	SWITCH, LEVER	
<TRANSFORMER>			
T501	1-437-195-11	TRANSFORMER, HORIZONTAL DRIVE	
T503 Δ	8-598-831-00	FBT ASSY, NX-4009	
T504	1-431-475-11	TRANSFORMER, HORIZONTAL LINEAR	
T505	1-426-981-11	TRANSFORMER, FERRITE (PMT)	
T601	1-431-536-11	TRANSFORMER, LINE FILTER	
T603 Δ	1-431-946-11	TRANSFORMER, CONVERTER	
T604 Δ	1-431-852-11	TRANSFORMER, CONVERTER (SRT)	
<THERMISTOR>			
THP600	1-809-827-11	THERMISTOR, POSITIVE	
<TUNER>			
TU101	8-598-450-10	TUNER, FSS BTF-LG434	
<CRYSTAL>			
X001	1-781-174-21	VIBRATOR, CERAMIC	
X301	1-781-134-21	VIBRATOR, CRYSTAL	
X302	1-781-132-21	VIBRATOR, CRYSTAL	

* A-1136-060-A	B BOARD COMPLETE *****		
4-382-854-11	SCREW (M3X10), P, SW (+)		
<CAPACITOR>			
C1201	1-107-725-11	CERAMIC CHIP 0.1MF	10% 16V
C1202	1-107-725-11	CERAMIC CHIP 0.1MF	10% 16V
C1203	1-164-505-11	CERAMIC CHIP 2.2MF	16V
C1204	1-115-419-11	CERAMIC CHIP 3300PF	5% 25V
C1205	1-115-419-11	CERAMIC CHIP 3300PF	5% 25V
C1206	1-126-965-11	ELECT 22MF	20% 50V
C1207	1-107-725-11	CERAMIC CHIP 0.1MF	10% 16V
C1208	1-126-023-11	ELECT 100MF	20% 16V
C1209	1-164-505-11	CERAMIC CHIP 2.2MF	16V
C1210	1-107-823-11	CERAMIC CHIP 0.47MF	10% 16V

REF. NO.	PART NO.	DESCRIPTION	REMARK
C1211	1-164-492-11	CERAMIC CHIP 0.15MF	10% 16V
C1212	1-107-823-11	CERAMIC CHIP 0.47MF	10% 16V
C1213	1-164-492-11	CERAMIC CHIP 0.15MF	10% 16V
C1214	1-126-055-11	ELECT 470MF	20% 50V
C1215	1-126-055-11	ELECT 470MF	20% 50V
C1219	1-126-961-11	ELECT 2.2MF	20% 50V
C1220	1-126-961-11	ELECT 2.2MF	20% 50V
C1221	1-126-933-11	ELECT 100MF	20% 16V
C1222	1-136-171-00	MYLAR 0.33MF	5% 50V
C1223	1-163-989-11	CERAMIC CHIP 0.033MF	10% 25V
C1224	1-164-346-11	CERAMIC CHIP 1MF	16V
C1225	1-164-005-11	CERAMIC CHIP 0.47MF	25V
C1226	1-163-243-11	CERAMIC CHIP 47PF	5% 50V
C1227	1-126-963-11	ELECT 4.7MF	20% 50V
C1228	1-163-251-11	CERAMIC CHIP 100PF	5% 50V
C1229	1-164-346-11	CERAMIC CHIP 1MF	16V
C1231	1-126-964-11	ELECT 10MF	20% 50V
C1232	1-126-022-11	ELECT 47MF	20% 16V
C1233	1-163-251-11	CERAMIC CHIP 100PF	5% 50V
C1234	1-164-346-11	CERAMIC CHIP 1MF	16V
C1235	1-163-243-11	CERAMIC CHIP 47PF	5% 50V
C1236	1-126-963-11	ELECT 4.7MF	20% 50V
C1237	1-164-346-11	CERAMIC CHIP 1MF	16V
C1238	1-164-005-11	CERAMIC CHIP 0.47MF	25V
C1239	1-136-171-00	MYLAR 0.33MF	5% 50V
C1240	1-163-989-11	CERAMIC CHIP 0.033MF	10% 25V
C1241	1-115-339-11	CERAMIC CHIP 0.1MF	10% 50V
C1242	1-163-275-11	CERAMIC CHIP 0.001MF	5% 50V
C1243	1-115-339-11	CERAMIC CHIP 0.1MF	10% 50V
C1244	1-110-617-51	ELECT 2200MF	20% 50V
C1245	1-115-339-11	CERAMIC CHIP 0.1MF	10% 50V
C1246	1-107-823-11	CERAMIC CHIP 0.47MF	10% 16V
C1247	1-163-275-11	CERAMIC CHIP 0.001MF	5% 50V
C1248	1-110-617-51	ELECT 2200MF	20% 50V
C1251	1-163-017-00	CERAMIC CHIP 0.0047MF	10% 50V
C1252	1-163-251-11	CERAMIC CHIP 100PF	5% 50V
C1253	1-115-339-11	CERAMIC CHIP 0.1MF	10% 50V
C1254	1-136-177-00	MYLAR 1MF	5% 50V
C1255	1-163-009-11	CERAMIC CHIP 0.001MF	10% 50V
C1256	1-127-682-51	ELECT MELF 2200MF	20% 25V
C1258	1-115-339-11	CERAMIC CHIP 0.1MF	10% 50V
C1259	1-115-339-11	CERAMIC CHIP 0.1MF	10% 50V
C1260	1-107-823-11	CERAMIC CHIP 0.47MF	10% 16V
C1263	1-163-017-00	CERAMIC CHIP 0.0047MF	10% 50V
C1264	1-163-251-11	CERAMIC CHIP 100PF	5% 50V
C1265	1-115-339-11	CERAMIC CHIP 0.1MF	10% 50V
C1266	1-136-177-00	MYLAR 1MF	5% 50V
C1267	1-163-009-11	CERAMIC CHIP 0.001MF	10% 50V
C1268	1-127-682-51	ELECT MELF 2200MF	20% 25V
C1270	1-163-007-11	CERAMIC CHIP 680PF	10% 50V
C1271	1-163-007-11	CERAMIC CHIP 680PF	10% 50V
C1273	1-163-275-11	CERAMIC CHIP 0.001MF	5% 50V
C1274	1-163-275-11	CERAMIC CHIP 0.001MF	5% 50V
C1275	1-163-007-11	CERAMIC CHIP 680PF	10% 50V
C1276	1-163-007-11	CERAMIC CHIP 680PF	10% 50V
C1277	1-164-690-91	CERAMIC CHIP 0.0022MF	5% 50V
C1279	1-164-690-91	CERAMIC CHIP 0.0022MF	5% 50V

B

REF. NO.	PART NO.	DESCRIPTION	REMARK	REF. NO.	PART NO.	DESCRIPTION	REMARK
C1281	1-115-339-11	CERAMIC CHIP	0.1MF 10% 50V	C3313	1-126-935-11	ELECT	470MF 20% 16V
C1282	1-115-339-11	CERAMIC CHIP	0.1MF 10% 50V	C3314	1-164-346-11	CERAMIC CHIP	1MF 16V
C1283	1-164-690-91	CERAMIC CHIP	0.0022MF 5% 50V	C3315	1-104-664-11	ELECT	47MF 20% 25V
C1284	1-164-690-91	CERAMIC CHIP	0.0022MF 5% 50V	C3316	1-164-346-11	CERAMIC CHIP	1MF 16V
C1301	1-126-967-11	ELECT	47MF 20% 50V	C3317	1-104-664-11	ELECT	47MF 20% 25V
C1303	1-163-243-11	CERAMIC CHIP	47PF 5% 50V	C3318	1-163-031-11	CERAMIC CHIP	0.01MF 50V
C1304	1-163-243-11	CERAMIC CHIP	47PF 5% 50V	C3319	1-163-251-11	CERAMIC CHIP	100PF 5% 50V
C1305	1-163-243-11	CERAMIC CHIP	47PF 5% 50V	C3320	1-164-004-11	CERAMIC CHIP	0.1MF 10% 25V
C1306	1-163-233-11	CERAMIC CHIP	18PF 5% 50V	C3322	1-164-346-11	CERAMIC CHIP	1MF 16V
C1307	1-126-933-11	ELECT	100MF 20% 16V	C3323	1-164-346-11	CERAMIC CHIP	1MF 16V
C1308	1-163-038-91	CERAMIC CHIP	0.1MF 25V	C3324	1-163-251-11	CERAMIC CHIP	100PF 5% 50V
C1309	1-126-963-11	ELECT	4.7MF 20% 50V	C3325	1-164-346-11	CERAMIC CHIP	1MF 16V
C1310	1-163-038-91	CERAMIC CHIP	0.1MF 25V	C3326	1-164-346-11	CERAMIC CHIP	1MF 16V
C1311	1-163-233-11	CERAMIC CHIP	18PF 5% 50V	C3327	1-163-251-11	CERAMIC CHIP	100PF 5% 50V
C1312	1-163-038-91	CERAMIC CHIP	0.1MF 25V	C3328	1-164-004-11	CERAMIC CHIP	0.1MF 10% 25V
C1313	1-126-964-11	ELECT	10MF 20% 50V	C3329	1-126-966-11	ELECT	33MF 20% 50V
C1314	1-126-957-11	ELECT	0.22MF 20% 50V	C3330	1-107-725-11	CERAMIC CHIP	0.1MF 10% 16V
C1315	1-163-259-91	CERAMIC CHIP	220PF 5% 50V	C3331	1-126-933-11	ELECT	100MF 20% 16V
C1316	1-126-963-11	ELECT	4.7MF 20% 50V	C3332	1-104-664-11	ELECT	47MF 20% 25V
C1317	1-126-933-11	ELECT	100MF 20% 16V	C3333	1-164-004-11	CERAMIC CHIP	0.1MF 10% 25V
C1318	1-107-725-11	CERAMIC CHIP	0.1MF 10% 16V	C3334	1-163-133-00	CERAMIC CHIP	470PF 5% 50V
C1319	1-163-038-91	CERAMIC CHIP	0.1MF 25V	C3335	1-163-038-91	CERAMIC CHIP	0.1MF 25V
C1320	1-163-038-91	CERAMIC CHIP	0.1MF 25V	C3336	1-126-933-11	ELECT	100MF 20% 16V
C1321	1-163-038-91	CERAMIC CHIP	0.1MF 25V	C3338	1-163-005-11	CERAMIC CHIP	470PF 10% 50V
C1323	1-126-967-11	ELECT	47MF 20% 50V	C3339	1-163-133-00	CERAMIC CHIP	470PF 5% 50V
C1324	1-126-967-11	ELECT	47MF 20% 50V	C3340	1-163-133-00	CERAMIC CHIP	470PF 5% 50V
C1325	1-163-038-91	CERAMIC CHIP	0.1MF 25V	C3341	1-163-133-00	CERAMIC CHIP	470PF 5% 50V
C1326	1-126-933-11	ELECT	100MF 20% 16V	C3342	1-163-133-00	CERAMIC CHIP	470PF 5% 50V
C1327	1-107-725-11	CERAMIC CHIP	0.1MF 10% 16V	C3343	1-163-133-00	CERAMIC CHIP	470PF 5% 50V
C1328	1-104-665-11	ELECT	100MF 20% 25V	C3344	1-164-005-11	CERAMIC CHIP	0.47MF 25V
C1329	1-163-038-91	CERAMIC CHIP	0.1MF 25V	C3345	1-163-133-00	CERAMIC CHIP	470PF 5% 50V
C1330	1-126-965-11	ELECT	22MF 20% 50V	C3346	1-163-133-00	CERAMIC CHIP	470PF 5% 50V
C1331	1-163-038-91	CERAMIC CHIP	0.1MF 25V	C3347	1-126-964-11	ELECT	10MF 20% 50V
C1332	1-126-960-11	ELECT	1MF 20% 50V	C3348	1-164-005-11	CERAMIC CHIP	0.47MF 25V
C1333	1-126-933-11	ELECT	100MF 20% 16V	C3349	1-126-933-11	ELECT	100MF 20% 16V
C1334	1-126-933-11	ELECT	100MF 20% 16V	C3350	1-163-005-11	CERAMIC CHIP	470PF 10% 50V
C1335	1-163-017-00	CERAMIC CHIP	0.0047MF 10% 50V	C3351	1-163-005-11	CERAMIC CHIP	470PF 10% 50V
C1336	1-163-038-91	CERAMIC CHIP	0.1MF 25V	C3352	1-163-005-11	CERAMIC CHIP	470PF 10% 50V
C1337	1-163-038-91	CERAMIC CHIP	0.1MF 25V	C3353	1-126-933-11	ELECT	100MF 20% 16V
C1342	1-164-005-11	CERAMIC CHIP	0.47MF 25V	C3354	1-126-967-11	ELECT	47MF 20% 50V
C1345	1-163-038-91	CERAMIC CHIP	0.1MF 25V	C3355	1-126-967-11	ELECT	47MF 20% 50V
C1350	1-163-243-11	CERAMIC CHIP	47PF 5% 50V	C3356	1-163-037-11	CERAMIC CHIP	0.022MF 10% 50V
C1352	1-164-005-11	CERAMIC CHIP	0.47MF 25V	C3357	1-163-037-11	CERAMIC CHIP	0.022MF 10% 50V
C1353	1-163-038-91	CERAMIC CHIP	0.1MF 25V	C3358	1-163-009-11	CERAMIC CHIP	0.001MF 10% 50V
C1354	1-163-038-91	CERAMIC CHIP	0.1MF 25V	C3360	1-104-664-11	ELECT	47MF 20% 25V
C1356	1-126-768-11	ELECT	2200MF 20% 16V	C3361	1-126-964-11	ELECT	10MF 20% 50V
C1358	1-164-690-91	CERAMIC CHIP	0.0022MF 5% 50V	C3362	1-126-964-11	ELECT	10MF 20% 50V
C1359	1-164-505-11	CERAMIC CHIP	2.2MF 16V	C3363	1-104-664-11	ELECT	47MF 20% 25V
C1360	1-164-505-11	CERAMIC CHIP	2.2MF 16V	C3364	1-126-964-11	ELECT	10MF 20% 50V
C3301	1-104-664-11	ELECT	47MF 20% 25V	C3365	1-126-964-11	ELECT	10MF 20% 50V
C3302	1-163-038-91	CERAMIC CHIP	0.1MF 25V	C3370	1-164-346-11	CERAMIC CHIP	1MF 16V
C3303	1-104-664-11	ELECT	47MF 20% 25V	C3372	1-163-038-91	CERAMIC CHIP	0.1MF 25V
C3304	1-164-004-11	CERAMIC CHIP	0.1MF 10% 25V	C3373	1-126-964-11	ELECT	10MF 20% 50V
C3306	1-163-251-11	CERAMIC CHIP	100PF 5% 50V	C3374	1-126-964-11	ELECT	10MF 20% 50V
C3307	1-126-933-11	ELECT	100MF 20% 16V	C3375	1-126-964-11	ELECT	10MF 20% 50V
C3308	1-126-964-11	ELECT	10MF 20% 50V	C3379	1-164-004-11	CERAMIC CHIP	0.1MF 10% 25V
C3310	1-126-964-11	ELECT	10MF 20% 50V				
C3312	1-104-664-11	ELECT	47MF 20% 25V				

B

REF. NO.	PART NO.	DESCRIPTION		REMARK
C3380	1-164-004-11	CERAMIC CHIP	0.1MF	10% 25V
C5201	1-107-725-11	CERAMIC CHIP	0.1MF	10% 16V
C5202	1-126-967-11	ELECT	47MF	20% 50V
C5203	1-126-963-11	ELECT	4.7MF	20% 50V
C5204	1-107-725-11	CERAMIC CHIP	0.1MF	10% 16V
C5205	1-127-532-11	ELECT	47MF	20% 6.3V
C5206	1-126-967-11	ELECT	47MF	20% 50V
C5207	1-126-967-11	ELECT	47MF	20% 50V
C5208	1-127-532-11	ELECT	47MF	20% 6.3V
C5209	1-107-725-11	CERAMIC CHIP	0.1MF	10% 16V
C5210	1-126-963-11	ELECT	4.7MF	20% 50V
C5211	1-164-690-91	CERAMIC CHIP	0.0022MF	5% 50V
C5212	1-164-690-91	CERAMIC CHIP	0.0022MF	5% 50V
C5213	1-163-227-11	CERAMIC CHIP	10PF	0.5PF 50V
C5214	1-163-275-11	CERAMIC CHIP	0.001MF	5% 50V
C5215	1-163-243-11	CERAMIC CHIP	47PF	5% 50V
C5216	1-107-725-11	CERAMIC CHIP	0.1MF	10% 16V
C5217	1-126-967-11	ELECT	47MF	20% 50V
C5218	1-126-967-11	ELECT	47MF	20% 50V
C5219	1-107-725-11	CERAMIC CHIP	0.1MF	10% 16V
C5220	1-107-725-11	CERAMIC CHIP	0.1MF	10% 16V
C5221	1-127-532-11	ELECT	47MF	20% 6.3V
C5223	1-164-690-91	CERAMIC CHIP	0.0022MF	5% 50V
C5224	1-164-690-91	CERAMIC CHIP	0.0022MF	5% 50V
C5225	1-126-963-11	ELECT	4.7MF	20% 50V
C5226	1-126-963-11	ELECT	4.7MF	20% 50V
C5227	1-107-725-11	CERAMIC CHIP	0.1MF	10% 16V
C5228	1-107-725-11	CERAMIC CHIP	0.1MF	10% 16V
C5229	1-107-725-11	CERAMIC CHIP	0.1MF	10% 16V
C5230	1-126-967-11	ELECT	47MF	20% 50V
C5231	1-107-725-11	CERAMIC CHIP	0.1MF	10% 16V
C5232	1-107-725-11	CERAMIC CHIP	0.1MF	10% 16V
C5233	1-126-960-11	ELECT	1MF	20% 50V
C5234	1-107-725-11	CERAMIC CHIP	0.1MF	10% 16V
C5235	1-107-725-11	CERAMIC CHIP	0.1MF	10% 16V
C5237	1-126-933-11	ELECT	100MF	20% 16V
C5238	1-107-725-11	CERAMIC CHIP	0.1MF	10% 16V
C5239	1-107-725-11	CERAMIC CHIP	0.1MF	10% 16V
C5240	1-126-933-11	ELECT	100MF	20% 16V
C5241	1-126-933-11	ELECT	100MF	20% 16V
C5242	1-164-346-11	CERAMIC CHIP	1MF	16V
C5243	1-164-346-11	CERAMIC CHIP	1MF	16V
C5247	1-107-823-11	CERAMIC CHIP	0.47MF	10% 16V
C5248	1-107-823-11	CERAMIC CHIP	0.47MF	10% 16V
C5249	1-164-690-91	CERAMIC CHIP	0.0022MF	5% 50V
C5300	1-164-005-11	CERAMIC CHIP	0.47MF	25V
C5302	1-164-005-11	CERAMIC CHIP	0.47MF	25V
C5304	1-164-005-11	CERAMIC CHIP	0.47MF	25V
C5306	1-164-005-11	CERAMIC CHIP	0.47MF	25V
C5308	1-164-004-11	CERAMIC CHIP	0.1MF	10% 25V
C5309	1-164-346-11	CERAMIC CHIP	1MF	16V
C5310	1-164-346-11	CERAMIC CHIP	1MF	16V
C5311	1-164-346-11	CERAMIC CHIP	1MF	16V
C5312	1-164-346-11	CERAMIC CHIP	1MF	16V
C5313	1-164-346-11	CERAMIC CHIP	1MF	16V
C5314	1-164-346-11	CERAMIC CHIP	1MF	16V
C5315	1-163-243-11	CERAMIC CHIP	47PF	5% 50V

REF. NO.	PART NO.	DESCRIPTION		REMARK
C5317	1-164-005-11	CERAMIC CHIP	0.47MF	25V
C5318	1-126-967-11	ELECT	47MF	20% 50V
C5319	1-163-249-11	CERAMIC CHIP	82PF	5% 50V
C5320	1-163-249-11	CERAMIC CHIP	82PF	5% 50V
C5322	1-164-005-11	CERAMIC CHIP	0.47MF	25V
C5323	1-163-121-00	CERAMIC CHIP	150PF	5% 50V
C5324	1-163-113-00	CERAMIC CHIP	68PF	5% 50V
C5325	1-163-249-11	CERAMIC CHIP	82PF	5% 50V
C5326	1-163-249-11	CERAMIC CHIP	82PF	5% 50V
C5328	1-164-005-11	CERAMIC CHIP	0.47MF	25V
C5329	1-163-121-00	CERAMIC CHIP	150PF	5% 50V
C5330	1-163-113-00	CERAMIC CHIP	68PF	5% 50V
C5331	1-104-760-11	CERAMIC CHIP	0.047MF	10% 50V
C5332	1-163-259-91	CERAMIC CHIP	220PF	5% 50V
C5333	1-163-243-11	CERAMIC CHIP	47PF	5% 50V
C5334	1-163-243-11	CERAMIC CHIP	47PF	5% 50V
C5335	1-163-243-11	CERAMIC CHIP	47PF	5% 50V
<CONNECTOR>				
CN1201*	1-564-506-11	PLUG, CONNECTOR 3P		
CN1204*	1-564-507-11	PLUG, CONNECTOR 4P		
CN1205*	1-564-507-11	PLUG, CONNECTOR 4P		
CN1301*	1-564-506-11	PLUG, CONNECTOR 3P		
CN1303*	1-564-511-11	PLUG, CONNECTOR 8P		
CN1304*	1-779-891-11	CONNECTOR, BOARD TO BOARD 8P		
CN1305*	1-779-892-11	CONNECTOR, BOARD TO BOARD 10P		
CN1306*	1-779-892-11	CONNECTOR, BOARD TO BOARD 10P		
CN1307*	1-779-891-11	CONNECTOR, BOARD TO BOARD 8P		
CN1308*	1-573-296-21	CONNECTOR, BOARD TO BOARD 10P		
CN1309	1-764-818-11	CONNECTOR, BOARD TO BOARD 10P		
CN1310	1-764-820-11	CONNECTOR, BOARD TO BOARD 12P		
CN1311*	1-564-506-11	PLUG, CONNECTOR 3P		
CN1312*	1-508-784-21	PIN, CONNECTOR (5MM PITCH) 1P		
CN1313*	1-564-509-11	PLUG, CONNECTOR 6P		
<DIODE>				
D1201	8-719-073-01	DIODE MA111-(K8).S0		
D1202	8-719-073-01	DIODE MA111-(K8).S0		
D1203	8-719-073-01	DIODE MA111-(K8).S0		
D1204	8-719-073-01	DIODE MA111-(K8).S0		
D1205	8-719-069-60	DIODE UDZS-TE17-9.1B		
D1302	8-719-073-01	DIODE MA111-(K8).S0		
D1306	8-719-908-03	DIODE GP08D		
D3301	8-719-069-60	DIODE UDZS-TE17-9.1B		
D3302	8-719-069-60	DIODE UDZS-TE17-9.1B		
D3303	8-719-069-60	DIODE UDZS-TE17-9.1B		
D3304	8-719-069-60	DIODE UDZS-TE17-9.1B		
D3305	8-719-069-60	DIODE UDZS-TE17-9.1B		
D3306	8-719-069-60	DIODE UDZS-TE17-9.1B		
D3307	8-719-069-60	DIODE UDZS-TE17-9.1B		
D3308	8-719-069-60	DIODE UDZS-TE17-9.1B		
D3309	8-719-069-60	DIODE UDZS-TE17-9.1B		
D3310	8-719-069-60	DIODE UDZS-TE17-9.1B		
D3311	8-719-069-60	DIODE UDZS-TE17-9.1B		
D3312	8-719-069-60	DIODE UDZS-TE17-9.1B		

B

REF. NO.	PART NO.	DESCRIPTION	REMARK	REF. NO.	PART NO.	DESCRIPTION	REMARK
		<FERRITE BEAD>				<COIL>	
FB1205	1-410-397-21	FERRITE 1.1UH		L1201	1-414-187-11	INDUCTOR 47UH	
FB1206	1-410-397-21	FERRITE 1.1UH		L1202	1-416-857-11	INDUCTOR 65UH	
FB1207	1-410-397-21	FERRITE 1.1UH		L1203	1-416-857-11	INDUCTOR 65UH	
FB1208	1-410-397-21	FERRITE 1.1UH		L1301	1-414-189-31	INDUCTOR 100UH	
FB5201	1-410-397-21	FERRITE 1.1UH		L1302	1-412-537-31	INDUCTOR 100UH	
FB5202	1-414-598-11	INDUCTOR CHIP 0UH		L1303	1-414-185-41	INDUCTOR 22UH	
FB5203	1-414-598-11	INDUCTOR CHIP 0UH		L1304	1-412-537-31	INDUCTOR 100UH	
FB5204	1-414-598-11	INDUCTOR CHIP 0UH		L1305	1-414-186-31	INDUCTOR 33UH	
FB5205	1-414-598-11	INDUCTOR CHIP 0UH		L1306	1-414-857-11	INDUCTOR 100UH	
FB5206	1-414-598-11	INDUCTOR CHIP 0UH		L1307	1-414-187-11	INDUCTOR 47UH	
FB5207	1-414-598-11	INDUCTOR CHIP 0UH		L1308	1-414-187-11	INDUCTOR 47UH	
FB5208	1-414-598-11	INDUCTOR CHIP 0UH		L1309	1-414-857-11	INDUCTOR 100UH	
FB5209	1-414-598-11	INDUCTOR CHIP 0UH		L1310	1-414-187-11	INDUCTOR 47UH	
		<FILTER>		L1311	1-414-187-11	INDUCTOR 47UH	
FL5201	1-239-803-11	ENCAPSULATED COMPONENT		L1312	1-414-856-11	INDUCTOR 10UH	
		<IC>		L1313	1-414-856-11	INDUCTOR 10UH	
IC1201	8-759-273-12	IC TDA7315D013TR		L1314	1-414-856-11	INDUCTOR 10UH	
IC1202	8-759-100-96	IC UPC4558G2		L3302	1-414-856-11	INDUCTOR 10UH	
IC1203	8-759-553-45	IC TDA7481		L3303	1-414-856-11	INDUCTOR 10UH	
IC1204	8-759-553-45	IC TDA7481		L3304	1-414-856-11	INDUCTOR 10UH	
IC1301	8-752-090-41	IC CXA2139S		L3305	1-414-856-11	INDUCTOR 10UH	
IC1302	8-759-542-15	IC TDA9178		L3306	1-414-856-11	INDUCTOR 10UH	
IC1303	8-759-231-53	IC TA7805S		L5201	1-408-595-31	INDUCTOR 2.2UH	
IC1304	8-759-445-59	IC BA033T				<IC LINK>	
IC1305	8-759-701-59	IC NJM78M09FA		PS1201	1-532-686-21	LINK, IC 2.7A/150V	
IC1307	8-759-278-95	IC BA7606F		PS1202	1-532-686-21	LINK, IC 2.7A/150V	
IC1308	8-759-439-64	IC HEF4053BT		PS1203	1-532-686-21	LINK, IC 2.7A/150V	
IC1309	8-759-439-64	IC HEF4053BT		PS1204	1-532-686-21	LINK, IC 2.7A/150V	
IC1310	8-759-450-47	IC BA05T				<TRANSISTOR>	
IC1311	8-759-337-26	IC MM1115XFBE		Q1201	8-729-224-62	TRANSISTOR 2SK246-GR	
IC3302	8-759-100-96	IC UPC4558G2		Q1202	8-729-230-49	TRANSISTOR 2SC2712-YG	
IC3303	8-752-068-46	IC CXA1855S		Q1203	8-729-230-49	TRANSISTOR 2SC2712-YG	
IC5201	8-759-549-74	IC TC9447F-003		Q1204	8-729-224-62	TRANSISTOR 2SK246-GR	
IC5202	8-759-042-02	IC S-80743AL-A7-S		Q1205	1-801-806-11	TRANSISTOR DTC144EKA-T146	
IC5203	8-759-358-38	IC NJM78M05DLA(Te1)		Q1205	8-729-421-19	TRANSISTOR UN2213	
IC5204	8-759-100-96	IC UPC4558G2		Q1206	8-729-230-49	TRANSISTOR 2SC2712-YG	
		<JACK>		Q1207	8-729-230-49	TRANSISTOR 2SC2712-YG	
J3301	1-784-646-11	TERMINAL, S		Q1301	8-729-230-49	TRANSISTOR 2SC2712-YG	
J3302	1-778-387-11	JACK BLOCK, PIN 12P		Q1302	8-729-216-22	TRANSISTOR 2SA1162-G	
		<CHIP CONDUCTOR>		Q1303	8-729-230-49	TRANSISTOR 2SC2712-YG	
JR1205	1-216-295-91	SHORT 0		Q1304	8-729-230-49	TRANSISTOR 2SC2712-YG	
JR1206	1-216-295-91	SHORT 0		Q1305	8-729-230-49	TRANSISTOR 2SC2712-YG	
JR1207	1-216-295-91	SHORT 0		Q1306	8-729-230-49	TRANSISTOR 2SC2712-YG	
JR1208	1-216-295-91	SHORT 0		Q1307	8-729-216-22	TRANSISTOR 2SA1162-G	
JR1209	1-216-295-91	SHORT 0		Q1308	8-729-230-49	TRANSISTOR 2SC2712-YG	
JR1301	1-216-295-91	SHORT 0		Q1309	8-729-230-49	TRANSISTOR 2SC2712-YG	
JR1305	1-216-295-91	SHORT 0		Q1310	8-729-230-49	TRANSISTOR 2SC2712-YG	
JR1311	1-216-295-91	SHORT 0		Q1311	8-729-216-22	TRANSISTOR 2SA1162-G	
JR5203	1-216-295-91	SHORT 0		Q1313	8-729-230-49	TRANSISTOR 2SC2712-YG	
				Q1314	8-729-230-49	TRANSISTOR 2SC2712-YG	
				Q1315	8-729-230-49	TRANSISTOR 2SC2712-YG	
				Q1316	8-729-216-22	TRANSISTOR 2SA1162-G	

B

REF. NO.	PART NO.	DESCRIPTION	REMARK	REF. NO.	PART NO.	DESCRIPTION	REMARK
Q1318	8-729-230-49	TRANSISTOR 2SC2712-YG		R1209	1-216-121-91	RES,CHIP 1M	5% 1/10W
Q1320	8-729-230-49	TRANSISTOR 2SC2712-YG		R1210	1-216-097-91	RES,CHIP 100K	5% 1/10W
Q1321	8-729-216-22	TRANSISTOR 2SA1162-G		R1211	1-216-097-91	RES,CHIP 100K	5% 1/10W
Q1322	8-729-230-49	TRANSISTOR 2SC2712-YG		R1212	1-216-061-00	RES,CHIP 3.3K	5% 1/10W
Q1323	8-729-216-22	TRANSISTOR 2SA1162-G		R1213	1-216-069-00	RES,CHIP 6.8K	5% 1/10W
Q1324	8-729-230-49	TRANSISTOR 2SC2712-YG		R1214	1-216-039-00	RES,CHIP 390	5% 1/10W
Q1325	8-729-230-49	TRANSISTOR 2SC2712-YG		R1215	1-216-101-00	RES,CHIP 150K	5% 1/10W
Q1326	8-729-230-49	TRANSISTOR 2SC2712-YG		R1216	1-216-113-00	RES,CHIP 470K	5% 1/10W
Q1329	8-729-230-49	TRANSISTOR 2SC2712-YG		R1217	1-216-057-00	RES,CHIP 2.2K	5% 1/10W
Q1332	8-729-216-22	TRANSISTOR 2SA1162-G		R1218	1-216-097-91	RES,CHIP 100K	5% 1/10W
Q1340	8-729-230-49	TRANSISTOR 2SC2712-YG		R1219	1-216-057-00	RES,CHIP 2.2K	5% 1/10W
Q1342	8-729-230-49	TRANSISTOR 2SC2712-YG		R1220	1-216-097-91	RES,CHIP 100K	5% 1/10W
Q1343	1-801-806-11	TRANSISTOR DTC144EKA-T146		R1221	1-216-073-00	RES,CHIP 10K	5% 1/10W
Q1344	1-801-806-11	TRANSISTOR DTC144EKA-T146		R1222	1-216-073-00	RES,CHIP 10K	5% 1/10W
Q1345	8-729-230-49	TRANSISTOR 2SC2712-YG		R1223	1-216-057-00	RES,CHIP 2.2K	5% 1/10W
Q3301	8-729-230-49	TRANSISTOR 2SC2712-YG		R1224	1-216-101-00	RES,CHIP 150K	5% 1/10W
Q3302	8-729-216-22	TRANSISTOR 2SA1162-G		R1225	1-216-113-00	RES,CHIP 470K	5% 1/10W
Q3303	8-729-230-49	TRANSISTOR 2SC2712-YG		R1226	1-216-057-00	RES,CHIP 2.2K	5% 1/10W
Q3304	8-729-230-49	TRANSISTOR 2SC2712-YG		R1227	1-216-049-91	RES,CHIP 1K	5% 1/10W
Q3305	8-729-230-49	TRANSISTOR 2SC2712-YG		R1228	1-216-097-91	RES,CHIP 100K	5% 1/10W
Q3306	8-729-230-49	TRANSISTOR 2SC2712-YG		R1229	1-216-121-91	RES,CHIP 1M	5% 1/10W
Q3307	8-729-216-22	TRANSISTOR 2SA1162-G		R1230	1-216-097-91	RES,CHIP 100K	5% 1/10W
Q3308	8-729-230-49	TRANSISTOR 2SC2712-YG		R1231	1-216-097-91	RES,CHIP 100K	5% 1/10W
Q3309	8-729-230-49	TRANSISTOR 2SC2712-YG		R1232	1-216-061-00	RES,CHIP 3.3K	5% 1/10W
Q3310	8-729-230-49	TRANSISTOR 2SC2712-YG		R1233	1-216-069-00	RES,CHIP 6.8K	5% 1/10W
Q3311	8-729-230-49	TRANSISTOR 2SC2712-YG		R1234	1-216-039-00	RES,CHIP 390	5% 1/10W
Q3312	8-729-230-49	TRANSISTOR 2SC2712-YG		R1236	1-208-808-11	METAL CHIP 12K	0.50% 1/10W
Q3313	8-729-230-49	TRANSISTOR 2SC2712-YG		R1237	1-216-085-00	RES,CHIP 33K	5% 1/10W
Q3314	8-729-230-49	TRANSISTOR 2SC2712-YG		R1238	1-216-081-00	RES,CHIP 22K	5% 1/10W
Q3315	8-729-230-49	TRANSISTOR 2SC2712-YG		R1239	1-216-067-00	RES,CHIP 5.6K	5% 1/10W
Q3316	8-729-216-22	TRANSISTOR 2SA1162-G		R1240	1-216-085-00	RES,CHIP 33K	5% 1/10W
Q3321	1-801-806-11	TRANSISTOR DTC144EKA-T146		R1241	1-215-890-11	METAL OXIDE 470	5% 2W F
Q3322	1-801-806-11	TRANSISTOR DTC144EKA-T146		R1242	1-215-890-11	METAL OXIDE 470	5% 2W F
Q3325	1-801-806-11	TRANSISTOR DTC144EKA-T146		R1244	1-216-073-00	RES,CHIP 10K	5% 1/10W
Q3326	8-729-230-49	TRANSISTOR 2SC2712-YG		R1246	1-208-808-11	METAL CHIP 12K	0.50% 1/10W
Q5300	8-729-216-22	TRANSISTOR 2SA1162-G		R1247	1-216-085-00	RES,CHIP 33K	5% 1/10W
Q5301	8-729-230-49	TRANSISTOR 2SC2712-YG		R1252	1-216-073-00	RES,CHIP 10K	5% 1/10W
Q5302	8-729-230-49	TRANSISTOR 2SC2712-YG		R1260	1-216-029-00	RES,CHIP 150	5% 1/10W
Q5303	8-729-216-22	TRANSISTOR 2SA1162-G		R1261	1-216-029-00	RES,CHIP 150	5% 1/10W
Q5304	8-729-230-49	TRANSISTOR 2SC2712-YG		R1264	1-216-041-00	RES,CHIP 470	5% 1/10W
Q5305	8-729-230-49	TRANSISTOR 2SC2712-YG		R1265	1-216-041-00	RES,CHIP 470	5% 1/10W
Q5306	8-729-230-49	TRANSISTOR 2SC2712-YG		R1266	1-216-049-91	RES,CHIP 1K	5% 1/10W
Q5307	8-729-230-49	TRANSISTOR 2SC2712-YG		R1278	1-216-033-00	RES,CHIP 220	5% 1/10W
Q5308	8-729-230-49	TRANSISTOR 2SC2712-YG		R1279	1-216-033-00	RES,CHIP 220	5% 1/10W
Q5309	8-729-230-49	TRANSISTOR 2SC2712-YG		R1280	1-216-029-00	RES,CHIP 150	5% 1/10W
Q5310	8-729-216-22	TRANSISTOR 2SA1162-G		R1281	1-216-029-00	RES,CHIP 150	5% 1/10W
				R1301	1-216-049-91	RES,CHIP 1K	5% 1/10W
		<RESISTOR>		R1302	1-216-025-91	RES,CHIP 100	5% 1/10W
R1201	1-216-033-00	RES,CHIP 220	5% 1/10W	R1304	1-216-073-00	RES,CHIP 10K	5% 1/10W
R1202	1-216-033-00	RES,CHIP 220	5% 1/10W	R1305	1-216-025-91	RES,CHIP 100	5% 1/10W
R1203	1-216-067-00	RES,CHIP 5.6K	5% 1/10W	R1306	1-216-025-91	RES,CHIP 100	5% 1/10W
R1204	1-216-067-00	RES,CHIP 5.6K	5% 1/10W	R1307	1-216-081-00	RES,CHIP 22K	5% 1/10W
R1205	1-216-089-91	RES,CHIP 47K	5% 1/10W	R1308	1-216-073-00	RES,CHIP 10K	5% 1/10W
R1206	1-216-089-91	RES,CHIP 47K	5% 1/10W	R1309	1-216-025-91	RES,CHIP 100	5% 1/10W
R1207	1-216-049-91	RES,CHIP 1K	5% 1/10W	R1310	1-216-041-00	RES,CHIP 470	5% 1/10W
R1208	1-216-097-91	RES,CHIP 100K	5% 1/10W	R1311	1-216-033-00	RES,CHIP 220	5% 1/10W
				R1312	1-216-005-00	RES,CHIP 15	5% 1/10W

B

REF. NO.	PART NO.	DESCRIPTION	REMARK	REF. NO.	PART NO.	DESCRIPTION	REMARK
R1313	1-216-295-91	SHORT	0	R1377	1-216-121-91	RES,CHIP	1M 5% 1/10W
R1314	1-216-041-00	RES,CHIP	470 5% 1/10W	R1378	1-216-073-00	RES,CHIP	10K 5% 1/10W
R1315	1-216-041-00	RES,CHIP	470 5% 1/10W	R1379	1-216-089-91	RES,CHIP	47K 5% 1/10W
R1316	1-216-025-91	RES,CHIP	100 5% 1/10W	R1380	1-216-097-91	RES,CHIP	100K 5% 1/10W
R1317	1-216-075-00	RES,CHIP	12K 5% 1/10W	R1381	1-216-073-00	RES,CHIP	10K 5% 1/10W
R1318	1-216-025-91	RES,CHIP	100 5% 1/10W	R1382	1-216-095-00	RES,CHIP	82K 5% 1/10W
R1319	1-216-045-00	RES,CHIP	680 5% 1/10W	R1383	1-216-089-91	RES,CHIP	47K 5% 1/10W
R1320	1-216-079-00	RES,CHIP	18K 5% 1/10W	R1384	1-216-025-91	RES,CHIP	100 5% 1/10W
R1321	1-208-806-11	METAL CHIP	10K 0.50% 1/10W	R1385	1-216-035-00	RES,CHIP	270 5% 1/10W
R1322	1-216-049-91	RES,CHIP	1K 5% 1/10W	R1386	1-216-033-00	RES,CHIP	220 5% 1/10W
R1323	1-216-049-91	RES,CHIP	1K 5% 1/10W	R1387	1-216-041-00	RES,CHIP	470 5% 1/10W
R1324	1-216-025-91	RES,CHIP	100 5% 1/10W	R1388	1-216-041-00	RES,CHIP	470 5% 1/10W
R1325	1-216-041-00	RES,CHIP	470 5% 1/10W	R1389	1-216-017-91	RES,CHIP	47 5% 1/10W
R1326	1-216-025-91	RES,CHIP	100 5% 1/10W	R1390	1-216-033-00	RES,CHIP	220 5% 1/10W
R1327	1-216-025-91	RES,CHIP	100 5% 1/10W	R1391	1-216-041-00	RES,CHIP	470 5% 1/10W
R1328	1-216-033-00	RES,CHIP	220 5% 1/10W	R1392	1-216-045-00	RES,CHIP	680 5% 1/10W
R1329	1-216-053-00	RES,CHIP	1.5K 5% 1/10W	R1393	1-216-027-00	RES,CHIP	120 5% 1/10W
R1330	1-216-073-00	RES,CHIP	10K 5% 1/10W	R1395	1-216-021-00	RES,CHIP	68 5% 1/10W
R1331	1-216-045-00	RES,CHIP	680 5% 1/10W	R1396	1-216-021-00	RES,CHIP	68 5% 1/10W
R1332	1-216-073-00	RES,CHIP	10K 5% 1/10W	R3300	1-216-105-91	RES,CHIP	220K 5% 1/10W
R1333	1-216-025-91	RES,CHIP	100 5% 1/10W	R3301	1-216-029-00	RES,CHIP	150 5% 1/10W
R1334	1-216-025-91	RES,CHIP	100 5% 1/10W	R3302	1-216-295-91	SHORT	0
R1335	1-216-041-00	RES,CHIP	470 5% 1/10W	R3303	1-216-049-91	RES,CHIP	1K 5% 1/10W
R1336	1-216-073-00	RES,CHIP	10K 5% 1/10W	R3304	1-216-029-00	RES,CHIP	150 5% 1/10W
R1337	1-216-041-00	RES,CHIP	470 5% 1/10W	R3305	1-216-017-91	RES,CHIP	47 5% 1/10W
R1338	1-216-041-00	RES,CHIP	470 5% 1/10W	R3306	1-216-049-91	RES,CHIP	1K 5% 1/10W
R1339	1-216-079-00	RES,CHIP	18K 5% 1/10W	R3307	1-216-029-00	RES,CHIP	150 5% 1/10W
R1340	1-216-049-91	RES,CHIP	1K 5% 1/10W	R3308	1-216-037-00	RES,CHIP	330 5% 1/10W
R1341	1-216-041-00	RES,CHIP	470 5% 1/10W	R3309	1-216-049-91	RES,CHIP	1K 5% 1/10W
R1342	1-216-041-00	RES,CHIP	470 5% 1/10W	R3310	1-216-025-91	RES,CHIP	100 5% 1/10W
R1343	1-216-049-91	RES,CHIP	1K 5% 1/10W	R3311	1-216-295-91	SHORT	0
R1344	1-216-065-91	RES,CHIP	4.7K 5% 1/10W	R3312	1-216-049-91	RES,CHIP	1K 5% 1/10W
R1345	1-216-041-00	RES,CHIP	470 5% 1/10W	R3313	1-216-025-91	RES,CHIP	100 5% 1/10W
R1347	1-216-049-91	RES,CHIP	1K 5% 1/10W	R3314	1-216-017-91	RES,CHIP	47 5% 1/10W
R1348	1-216-025-91	RES,CHIP	100 5% 1/10W	R3315	1-216-049-91	RES,CHIP	1K 5% 1/10W
R1349	1-216-075-00	RES,CHIP	12K 5% 1/10W	R3316	1-216-025-91	RES,CHIP	100 5% 1/10W
R1351	1-216-081-00	RES,CHIP	22K 5% 1/10W	R3317	1-216-037-00	RES,CHIP	330 5% 1/10W
R1352	1-216-049-91	RES,CHIP	1K 5% 1/10W	R3318	1-216-049-91	RES,CHIP	1K 5% 1/10W
R1353	1-216-049-91	RES,CHIP	1K 5% 1/10W	R3319	1-216-025-91	RES,CHIP	100 5% 1/10W
R1354	1-216-033-00	RES,CHIP	220 5% 1/10W	R3320	1-216-073-00	RES,CHIP	10K 5% 1/10W
R1356	1-216-049-91	RES,CHIP	1K 5% 1/10W	R3321	1-216-057-00	RES,CHIP	2.2K 5% 1/10W
R1357	1-216-025-91	RES,CHIP	100 5% 1/10W	R3323	1-216-025-91	RES,CHIP	100 5% 1/10W
R1358	1-216-041-00	RES,CHIP	470 5% 1/10W	R3324	1-216-073-00	RES,CHIP	10K 5% 1/10W
R1359	1-216-041-00	RES,CHIP	470 5% 1/10W	R3325	1-216-049-91	RES,CHIP	1K 5% 1/10W
R1360	1-216-041-00	RES,CHIP	470 5% 1/10W	R3326	1-216-025-91	RES,CHIP	100 5% 1/10W
R1361	1-216-041-00	RES,CHIP	470 5% 1/10W	R3327	1-216-063-91	RES,CHIP	3.9K 5% 1/10W
R1362	1-216-049-91	RES,CHIP	1K 5% 1/10W	R3328	1-216-025-91	RES,CHIP	100 5% 1/10W
R1363	1-216-041-00	RES,CHIP	470 5% 1/10W	R3329	1-216-089-91	RES,CHIP	47K 5% 1/10W
R1364	1-216-025-91	RES,CHIP	100 5% 1/10W	R3330	1-216-025-91	RES,CHIP	100 5% 1/10W
R1365	1-216-049-91	RES,CHIP	1K 5% 1/10W	R3331	1-216-025-91	RES,CHIP	100 5% 1/10W
R1366	1-216-041-00	RES,CHIP	470 5% 1/10W	R3332	1-216-041-00	RES,CHIP	470 5% 1/10W
R1367	1-216-049-91	RES,CHIP	1K 5% 1/10W	R3333	1-216-025-91	RES,CHIP	100 5% 1/10W
R1368	1-216-041-00	RES,CHIP	470 5% 1/10W	R3334	1-216-025-91	RES,CHIP	100 5% 1/10W
R1369	1-216-049-91	RES,CHIP	1K 5% 1/10W	R3335	1-216-022-00	RES,CHIP	75 5% 1/10W
R1370	1-216-041-00	RES,CHIP	470 5% 1/10W	R3336	1-216-025-91	RES,CHIP	100 5% 1/10W
R1373	1-216-041-00	RES,CHIP	470 5% 1/10W	R3337	1-216-065-91	RES,CHIP	4.7K 5% 1/10W
R1374	1-216-045-00	RES,CHIP	680 5% 1/10W	R3338	1-216-025-91	RES,CHIP	100 5% 1/10W
R1376	1-216-097-91	RES,CHIP	100K 5% 1/10W				

B

REF. NO.	PART NO.	DESCRIPTION	REMARK	REF. NO.	PART NO.	DESCRIPTION	REMARK
R3339	1-216-065-91	RES,CHIP	4.7K 5% 1/10W	R3399	1-216-025-91	RES,CHIP	100 5% 1/10W
R3341	1-216-065-91	RES,CHIP	4.7K 5% 1/10W	R5201	1-216-065-91	RES,CHIP	4.7K 5% 1/10W
R3342	1-216-049-91	RES,CHIP	1K 5% 1/10W	R5202	1-216-065-91	RES,CHIP	4.7K 5% 1/10W
R3343	1-216-049-91	RES,CHIP	1K 5% 1/10W	R5203	1-216-065-91	RES,CHIP	4.7K 5% 1/10W
R3344	1-216-089-91	RES,CHIP	47K 5% 1/10W	R5204	1-216-061-00	RES,CHIP	3.3K 5% 1/10W
R3345	1-216-025-91	RES,CHIP	100 5% 1/10W	R5205	1-216-061-00	RES,CHIP	3.3K 5% 1/10W
R3346	1-216-105-91	RES,CHIP	220K 5% 1/10W	R5206	1-216-129-00	RES,CHIP	2.2M 5% 1/10W
R3347	1-216-065-91	RES,CHIP	4.7K 5% 1/10W	R5207	1-216-035-00	RES,CHIP	270 5% 1/10W
R3348	1-216-048-00	RES,CHIP	910 5% 1/10W	R5208	1-216-035-00	RES,CHIP	270 5% 1/10W
R3349	1-216-073-00	RES,CHIP	10K 5% 1/10W	R5210	1-216-033-00	RES,CHIP	220 5% 1/10W
R3350	1-216-065-91	RES,CHIP	4.7K 5% 1/10W	R5211	1-216-033-00	RES,CHIP	220 5% 1/10W
R3351	1-216-065-91	RES,CHIP	4.7K 5% 1/10W	R5212	1-216-033-00	RES,CHIP	220 5% 1/10W
R3352	1-216-089-91	RES,CHIP	47K 5% 1/10W	R5214	1-216-061-00	RES,CHIP	3.3K 5% 1/10W
R3353	1-216-025-91	RES,CHIP	100 5% 1/10W	R5215	1-216-061-00	RES,CHIP	3.3K 5% 1/10W
R3354	1-216-025-91	RES,CHIP	100 5% 1/10W	R5216	1-216-049-91	RES,CHIP	1K 5% 1/10W
R3355	1-216-073-00	RES,CHIP	10K 5% 1/10W	R5217	1-216-049-91	RES,CHIP	1K 5% 1/10W
R3356	1-216-113-00	RES,CHIP	470K 5% 1/10W	R5218	1-216-075-00	RES,CHIP	12K 5% 1/10W
R3357	1-216-065-91	RES,CHIP	4.7K 5% 1/10W	R5219	1-216-075-00	RES,CHIP	12K 5% 1/10W
R3358	1-216-065-91	RES,CHIP	4.7K 5% 1/10W	R5220	1-216-073-00	RES,CHIP	10K 5% 1/10W
R3359	1-216-025-91	RES,CHIP	100 5% 1/10W	R5221	1-216-073-00	RES,CHIP	10K 5% 1/10W
R3360	1-216-295-91	SHORT	0	R5222	1-216-025-91	RES,CHIP	100 5% 1/10W
R3361	1-216-025-91	RES,CHIP	100 5% 1/10W	R5223	1-216-025-91	RES,CHIP	100 5% 1/10W
R3362	1-216-025-91	RES,CHIP	100 5% 1/10W	R5224	1-216-073-00	RES,CHIP	10K 5% 1/10W
R3363	1-216-073-00	RES,CHIP	10K 5% 1/10W	R5225	1-216-073-00	RES,CHIP	10K 5% 1/10W
R3364	1-216-113-00	RES,CHIP	470K 5% 1/10W	R5226	1-216-073-00	RES,CHIP	10K 5% 1/10W
R3365	1-216-113-00	RES,CHIP	470K 5% 1/10W	R5227	1-216-073-00	RES,CHIP	10K 5% 1/10W
R3366	1-216-295-91	SHORT	0	R5228	1-216-049-91	RES,CHIP	1K 5% 1/10W
R3367	1-216-057-00	RES,CHIP	2.2K 5% 1/10W	R5300	1-216-295-91	SHORT	0
R3368	1-216-093-91	RES,CHIP	68K 5% 1/10W	R5301	1-216-033-00	RES,CHIP	220 5% 1/10W
R3369	1-216-105-91	RES,CHIP	220K 5% 1/10W	R5302	1-216-029-00	RES,CHIP	150 5% 1/10W
R3370	1-216-105-91	RES,CHIP	220K 5% 1/10W	R5303	1-216-041-00	RES,CHIP	470 5% 1/10W
R3371	1-216-022-00	RES,CHIP	75 5% 1/10W	R5304	1-216-295-91	SHORT	0
R3372	1-216-295-91	SHORT	0	R5306	1-216-013-00	RES,CHIP	33 5% 1/10W
R3373	1-216-295-91	SHORT	0	R5307	1-216-033-00	RES,CHIP	220 5% 1/10W
R3374	1-216-295-91	SHORT	0	R5308	1-216-031-00	RES,CHIP	180 5% 1/10W
R3375	1-216-089-91	RES,CHIP	47K 5% 1/10W	R5309	1-216-041-00	RES,CHIP	470 5% 1/10W
R3377	1-216-022-00	RES,CHIP	75 5% 1/10W	R5310	1-216-689-11	RES,CHIP	39K 5% 1/10W
R3378	1-216-048-00	RES,CHIP	910 5% 1/10W	R5311	1-216-689-11	RES,CHIP	39K 5% 1/10W
R3379	1-216-105-91	RES,CHIP	220K 5% 1/10W	R5312	1-216-689-11	RES,CHIP	39K 5% 1/10W
R3380	1-216-105-91	RES,CHIP	220K 5% 1/10W	R5313	1-216-689-11	RES,CHIP	39K 5% 1/10W
R3381	1-216-022-00	RES,CHIP	75 5% 1/10W	R5314	1-216-689-11	RES,CHIP	39K 5% 1/10W
R3382	1-216-025-91	RES,CHIP	100 5% 1/10W	R5315	1-216-689-11	RES,CHIP	39K 5% 1/10W
R3383	1-216-025-91	RES,CHIP	100 5% 1/10W	R5316	1-216-049-91	RES,CHIP	1K 5% 1/10W
R3384	1-216-025-91	RES,CHIP	100 5% 1/10W	R5317	1-216-041-00	RES,CHIP	470 5% 1/10W
R3385	1-216-105-91	RES,CHIP	220K 5% 1/10W	R5318	1-216-041-00	RES,CHIP	470 5% 1/10W
R3386	1-216-067-00	RES,CHIP	5.6K 5% 1/10W	R5319	1-216-073-00	RES,CHIP	10K 5% 1/10W
R3387	1-216-089-91	RES,CHIP	47K 5% 1/10W	R5320	1-216-073-00	RES,CHIP	10K 5% 1/10W
R3388	1-216-089-91	RES,CHIP	47K 5% 1/10W	R5321	1-216-025-91	RES,CHIP	100 5% 1/10W
R3389	1-216-022-00	RES,CHIP	75 5% 1/10W	R5322	1-216-025-91	RES,CHIP	100 5% 1/10W
R3390	1-216-025-91	RES,CHIP	100 5% 1/10W	R5323	1-216-025-91	RES,CHIP	100 5% 1/10W
R3391	1-216-025-91	RES,CHIP	100 5% 1/10W	R5324	1-216-079-00	RES,CHIP	18K 5% 1/10W
R3392	1-216-021-00	RES,CHIP	68 5% 1/10W	R5325	1-216-075-00	RES,CHIP	12K 5% 1/10W
R3393	1-216-067-00	RES,CHIP	5.6K 5% 1/10W	R5326	1-216-073-00	RES,CHIP	10K 5% 1/10W
R3394	1-216-031-00	RES,CHIP	180 5% 1/10W	R5327	1-216-081-00	RES,CHIP	22K 5% 1/10W
R3395	1-216-033-00	RES,CHIP	220 5% 1/10W	R5328	1-216-073-00	RES,CHIP	10K 5% 1/10W
R3396	1-216-041-00	RES,CHIP	470 5% 1/10W	R5329	1-216-081-00	RES,CHIP	22K 5% 1/10W
R3397	1-216-041-00	RES,CHIP	470 5% 1/10W	R5330	1-216-081-00	RES,CHIP	22K 5% 1/10W
R3398	1-216-025-91	RES,CHIP	100 5% 1/10W				

The components identified by shading and mark Δ are critical for safety. Replace only with part number specified.



REF. NO.	PART NO.	DESCRIPTION	REMARK
	* A-1332-007-A	C BOARD MOUNTED *****	
	4-382-854-11	SCREW (M3X10), P, SW (+)	
		<CAPACITOR>	
C700	1-110-389-11	FILM MELF 0.1MF 5% 250V	
C701	1-162-114-00	CERAMIC 0.0047MF 2KV	
C702	1-102-074-00	CERAMIC 0.001MF 10% 50V	
C704	1-107-652-11	ELECT 10MF 20% 250V	
C707	1-137-399-11	MYLAR 0.1MF 5% 50V	
C708	1-102-228-00	CERAMIC 470PF 10% 500V	
C709	1-102-228-00	CERAMIC 470PF 10% 500V	
C710	1-102-960-00	CERAMIC 24PF 5% 50V	
C711	1-102-852-91	CERAMIC 47PF 5% 50V	
C712	1-102-525-11	CERAMIC 68PF 5% 50V	
C713	1-102-228-00	CERAMIC 470PF 10% 500V	
C716	1-126-968-11	ELECT 100MF 20% 50V	
C717	1-107-651-11	ELECT 4.7MF 20% 250V	
C726	1-104-664-11	ELECT 47MF 20% 25V	
C1800	1-126-964-11	ELECT 10MF 20% 50V	
C1803	1-126-964-11	ELECT 10MF 20% 50V	
C1804	1-126-964-11	ELECT 10MF 20% 50V	
C1809	1-126-942-61	ELECT 1000MF 20% 25V	
		<CONNECTOR>	
CN700	1-695-915-11	TAB (CONTACT)	
CN701	1-508-765-00	PIN, CONNECTOR (5MM PITCH) 3P	
CN702	1-695-915-11	TAB (CONTACT)	
CN703	* 1-564-509-11	PLUG, CONNECTOR 6P	
CN704	1-695-915-11	TAB (CONTACT)	
CN705	* 1-564-518-11	PLUG, CONNECTOR 3P	
CN1801	* 1-564-509-11	PLUG, CONNECTOR 6P	
CN1802	* 1-564-506-11	PLUG, CONNECTOR 3P	
		<DIODE>	
D700	8-719-911-19	DIODE 1SS119-25	
D701	8-719-911-19	DIODE 1SS119-25	
D702	8-719-911-19	DIODE 1SS119-25	
D703	8-719-911-19	DIODE 1SS119-25	
D704	8-719-911-19	DIODE 1SS119-25	
D705	8-719-051-85	DIODE HSS83TD	
D706	8-719-051-85	DIODE HSS83TD	
D707	8-719-051-85	DIODE HSS83TD	
D708	8-719-911-19	DIODE 1SS119-25	
D709	8-719-911-19	DIODE 1SS119-25	
D710	8-719-911-19	DIODE 1SS119-25	
D711	8-719-110-23	DIODE RD1HESB3	
D714	8-719-051-85	DIODE HSS83TD	
D715	8-719-051-85	DIODE HSS83TD	
D716	8-719-051-85	DIODE HSS83TD	
D720	8-719-911-19	DIODE 1SS119-25	
D721	8-719-911-19	DIODE 1SS119-25	
D722	8-719-911-19	DIODE 1SS119-25	
D1803	8-719-911-19	DIODE 1SS119-25	

REF. NO.	PART NO.	DESCRIPTION	REMARK
D1804	8-719-911-19	DIODE 1SS119-25	
D1808	8-719-908-03	DIODE GP08D	
		<IC>	
IC701	8-759-561-28	IC STV5112	
IC1800	8-759-822-38	IC LA6510	
		<JACK>	
J701	Δ 1-540-071-22	SOCKET, CRT	
		<COIL>	
L701	1-410-667-31	INDUCTOR 22UH	
L705	1-408-609-41	INDUCTOR 33UH	
L706	1-408-609-41	INDUCTOR 33UH	
L707	1-408-609-41	INDUCTOR 33UH	
		<TRANSISTOR>	
Q1800	8-729-119-76	TRANSISTOR 2SA1175-HFE	
Q1802	8-729-119-78	TRANSISTOR 2SC2785-HFE	
		<RESISTOR>	
R700	1-249-393-11	CARBON 10 5% 1/4W F	
R701	1-249-496-11	CARBON 100K 5% 1/2W	
R702	1-215-461-00	METAL 47K 1% 1/4W	
R703	1-215-414-00	METAL 510 1% 1/4W	
R704	1-215-414-00	METAL 510 1% 1/4W	
R705	1-249-417-11	CARBON 1K 5% 1/4W	
R706	1-249-417-11	CARBON 1K 5% 1/4W	
R707	1-215-414-00	METAL 510 1% 1/4W	
R708	1-249-417-11	CARBON 1K 5% 1/4W	
R709	1-215-903-11	METAL OXIDE 68K 5% 2W F	
R711	1-215-903-11	METAL OXIDE 68K 5% 2W F	
R712	1-215-903-11	METAL OXIDE 68K 5% 2W F	
R713	1-215-461-00	METAL 47K 1% 1/4W	
R714	1-249-425-11	CARBON 4.7K 5% 1/4W	
R715	1-249-413-11	CARBON 470 5% 1/4W	
R716	1-249-413-11	CARBON 470 5% 1/4W	
R717	1-249-425-11	CARBON 4.7K 5% 1/4W	
R718	1-247-752-11	CARBON 1K 5% 1/2W	
R719	1-249-425-11	CARBON 4.7K 5% 1/4W	
R722	1-247-752-11	CARBON 1K 5% 1/2W	
R723	1-249-413-11	CARBON 470 5% 1/4W	
R724	1-247-752-11	CARBON 1K 5% 1/2W	
R730	1-216-392-11	METAL OXIDE 1.8 5% 3W F	
R734	1-247-739-11	CARBON 100 5% 1/2W	
R744	1-215-415-00	METAL 560 1% 1/4W	
R745	1-215-410-00	METAL 360 1% 1/4W	
R1800	1-249-417-11	CARBON 1K 5% 1/4W	
R1801	1-249-426-11	CARBON 5.6K 5% 1/4W	
R1802	1-249-382-11	CARBON 1.2 5% 1/4W F	
R1803	1-249-382-11	CARBON 1.2 5% 1/4W F	



REF. NO.	PART NO.	DESCRIPTION	REMARK	REF. NO.	PART NO.	DESCRIPTION	REMARK
R1805	1-249-429-11	CARBON	10K 5% 1/4W			<CONNECTOR>	
R1806	1-249-425-11	CARBON	4.7K 5% 1/4W				
R1808	1-249-425-11	CARBON	4.7K 5% 1/4W	CN2821*	1-564-506-11	PLUG, CONNECTOR 3P	
R1809	1-249-435-11	CARBON	33K 5% 1/4W	CN2822*	1-564-510-11	PLUG, CONNECTOR 7P	
R1810	1-249-435-11	CARBON	33K 5% 1/4W	CN2823	1-695-915-11	TAB (CONTACT)	
R1811	1-249-440-11	CARBON	82K 5% 1/4W			<DIODE>	
R1812	1-249-435-11	CARBON	33K 5% 1/4W	D2801	8-719-073-01	DIODE MA111-(K8).S0	
R1821	1-249-440-11	CARBON	82K 5% 1/4W	D2803	8-719-063-73	DIODE D1NL20U-TR	
R1822	1-249-435-11	CARBON	33K 5% 1/4W	D2804	8-719-063-73	DIODE D1NL20U-TR	
R1823	1-249-426-11	CARBON	5.6K 5% 1/4W	D2806	8-719-302-43	DIODE EL1Z	
R1824	1-249-435-11	CARBON	33K 5% 1/4W	D2813	8-719-073-01	DIODE MA111-(K8).S0	
R1825	1-247-843-11	CARBON	3.3K 5% 1/4W				
		<VARIABLE RESISTOR>		D2814	8-719-210-21	DIODE 11EQS04	
RV702	1-241-656-11	RES, ADJ, METAL FILM 110M		D2815	8-719-911-19	DIODE 1SS119-25	
RV1801	1-223-241-11	RES, ADJ, CARBON 47K		D2816	8-719-911-19	DIODE 1SS119-25	
						<IC>	
				IC2801	8-759-700-07	IC NJM2903M	
				IC2803	8-759-701-59	IC NJM78M09FA	
				IC2805	8-759-510-71	IC BA10358F-E2	
				IC2806	8-759-700-07	IC NJM2903M	
						<CHIP CONDUCTOR>	
				JR2006	1-216-295-91	SHORT	0
				JR2803	1-216-295-91	SHORT	0
				JR2804	1-216-295-91	SHORT	0
				JR2805	1-216-295-91	SHORT	0
						<COIL>	
				L2801	1-406-677-11	INDUCTOR	10MMH
				L2802	1-459-111-00	INDUCTOR	10MMH
				L2803	1-414-502-21	INDUCTOR	33MMH
				L2806	1-406-678-11	INDUCTOR	15MMH
						<TRANSISTOR>	
				Q2802	8-729-216-22	TRANSISTOR 2SA1162-G	
				Q2805	8-729-216-22	TRANSISTOR 2SA1162-G	
				Q2806	8-729-230-49	TRANSISTOR 2SC2712-YG	
				Q2807	8-729-043-95	TRANSISTOR 2SC3840(3)	
				Q2811	8-729-931-45	TRANSISTOR IRF614	
				Q2813	8-729-230-49	TRANSISTOR 2SC2712-YG	
				Q2821	8-729-230-49	TRANSISTOR 2SC2712-YG	
				Q2822	8-729-216-22	TRANSISTOR 2SA1162-G	
				Q2823	8-729-017-06	TRANSISTOR 2SC4793	
				Q2824	8-729-140-97	TRANSISTOR 2SB734-34	
						<RESISTOR>	
				R2801	1-216-051-00	RES,CHIP	1.2K 5% 1/10W
				R2803	1-216-057-00	RES,CHIP	2.2K 5% 1/10W
				R2804	1-216-041-00	RES,CHIP	470 5% 1/10W
				R2806	1-216-057-00	RES,CHIP	2.2K 5% 1/10W
				R2809	1-216-073-00	RES,CHIP	10K 5% 1/10W
C2801	1-130-479-00	MYLAR	0.0047MF 5% 50V				
C2803	1-136-357-11	MYLAR	680PF 5% 50V				
C2805	1-104-664-11	ELECT	47MF 20% 25V				
C2806	1-136-559-11	MYLAR	0.0047MF 10% 400V				
C2809	1-126-964-11	ELECT	10MF 20% 50V				
C2810	1-102-228-00	CERAMIC	470PF 10% 500V				
C2811	1-107-938-11	ELECT	0.47MF 20% 160V				
C2813	1-107-636-11	ELECT	10MF 20% 160V				
C2814	1-126-964-11	ELECT	10MF 20% 50V				
C2817	1-102-244-00	CERAMIC	220PF 10% 500V				
C2818	1-129-928-00	FILM	0.0027MF 5% 630V				
C2819	1-104-664-11	ELECT	47MF 20% 25V				
C2820	1-107-714-11	ELECT	10MF 20% 16V				
C2821	1-130-469-00	MYLAR	680PF 5% 50V				
C2822	1-106-375-12	MYLAR	0.022MF 10% 250V				
C2824	1-104-664-11	ELECT	47MF 20% 25V				
C2825	1-130-338-91	FILM	0.01MF 5% 630V				
C2826	1-137-194-81	MYLAR	0.47MF 5% 50V				
C2828	1-107-714-11	ELECT	10MF 20% 16V				
C2829	1-164-161-11	CERAMIC CHIP	0.0022MF 10% 50V				
C2830	1-130-480-00	MYLAR	0.0056MF 5% 50V				
C2832	1-126-960-11	ELECT	1MF 20% 50V				
C2833	1-137-366-11	MYLAR	0.0022MF 5% 50V				
C2834	1-106-220-00	MYLAR	0.1MF 10% 100V				
C2835	1-216-295-91	SHORT	0				
C2837	1-102-129-00	CERAMIC	0.01MF 10% 50V				
C2840	1-137-466-11	MYLAR	0.082MF 5% 100V				
C2841	1-136-177-00	MYLAR	1MF 5% 50V				
C2842	1-130-477-00	MYLAR	0.0033MF 5% 50V				
C2843	1-107-714-11	ELECT	10MF 20% 16V				
C2900	1-130-480-00	MYLAR	0.0056MF 5% 50V				
C2901	1-126-964-11	ELECT	10MF 20% 50V				

D₂

DH

REF. NO.	PART NO.	DESCRIPTION	REMARK
R2812	1-216-097-91	RES,CHIP 100K	5% 1/10W
R2813	1-216-089-91	RES,CHIP 47K	5% 1/10W
R2816	1-216-097-91	RES,CHIP 100K	5% 1/10W
R2820	1-216-089-91	RES,CHIP 47K	5% 1/10W
R2821	1-249-412-11	CARBON 390	5% 1/4W F
R2824	1-249-393-11	CARBON 10	5% 1/4W F
R2825	1-216-037-00	RES,CHIP 330	5% 1/10W
R2827	1-216-041-00	RES,CHIP 470	5% 1/10W
R2830	1-215-899-11	METAL OXIDE 15K	5% 2W F
R2831	1-215-873-00	METAL OXIDE 4.7K	5% 1W F
R2833	1-216-460-11	METAL OXIDE 3.9K	5% 2W F
R2834	1-215-873-00	METAL OXIDE 4.7K	5% 1W F
R2837	1-216-063-91	RES,CHIP 3.9K	5% 1/10W
R2838	1-208-806-11	METAL CHIP 10K	0.50% 1/10W
R2839	1-216-081-00	RES,CHIP 22K	5% 1/10W
R2840	1-216-097-91	RES,CHIP 100K	5% 1/10W
R2843	1-216-097-91	RES,CHIP 100K	5% 1/10W
R2844	1-216-097-91	RES,CHIP 100K	5% 1/10W
R2846	1-216-057-00	RES,CHIP 2.2K	5% 1/10W
R2847	1-216-049-91	RES,CHIP 1K	5% 1/10W
R2857	1-208-802-11	METAL CHIP 6.8K	0.50% 1/10W
R2858	1-216-051-00	RES,CHIP 1.2K	5% 1/10W
R2859	1-216-057-00	RES,CHIP 2.2K	5% 1/10W
R2860	1-216-057-00	RES,CHIP 2.2K	5% 1/10W
R2861	1-216-107-00	RES,CHIP 270K	5% 1/10W
R2862	1-216-107-00	RES,CHIP 270K	5% 1/10W
R2866	1-216-073-00	RES,CHIP 10K	5% 1/10W
R2867	1-216-689-11	RES,CHIP 39K	5% 1/10W
R2869	1-216-113-00	RES,CHIP 470K	5% 1/10W
R2871	1-216-057-00	RES,CHIP 2.2K	5% 1/10W
R2872	1-216-057-00	RES,CHIP 2.2K	5% 1/10W
R2874	1-216-085-00	RES,CHIP 33K	5% 1/10W
R2877	1-216-421-11	METAL OXIDE 12	5% 1W F
R2878	1-216-081-00	RES,CHIP 22K	5% 1/10W
R2879	1-216-081-00	RES,CHIP 22K	5% 1/10W
R2880	1-216-073-00	RES,CHIP 10K	5% 1/10W
R2882	1-216-069-00	RES,CHIP 6.8K	5% 1/10W
R2883	1-216-067-00	RES,CHIP 5.6K	5% 1/10W
R2884	1-216-067-00	RES,CHIP 5.6K	5% 1/10W
R2885	1-216-089-91	RES,CHIP 47K	5% 1/10W
R2886	1-216-063-91	RES,CHIP 3.9K	5% 1/10W
R2887	1-208-782-11	METAL CHIP 1K	0.50% 1/10W
R2888	1-216-049-91	RES,CHIP 1K	5% 1/10W
R2889	1-216-101-00	RES,CHIP 150K	5% 1/10W
R2900	1-216-089-91	RES,CHIP 47K	5% 1/10W
R2901	1-216-089-91	RES,CHIP 47K	5% 1/10W
R2902	1-216-089-91	RES,CHIP 47K	5% 1/10W
		<SWITCH>	
S2801	1-572-707-11	SWITCH, LEVER	
		<TRANSFORMER>	
T2801	1-424-584-11	TRANSFORMER, DYNAMIC FOCUS	

REF. NO.	PART NO.	DESCRIPTION	REMARK
	* A-1343-759-A	DH BOARD MOUNTED	*****
		<CAPACITOR>	
C3801	1-126-964-11	ELECT 10MF	20% 50V
C3804	1-102-129-00	CERAMIC 0.01MF	10% 50V
C3805	1-126-964-11	ELECT 10MF	20% 50V
C3807	1-102-129-00	CERAMIC 0.01MF	10% 50V
C3816	1-126-964-11	ELECT 10MF	20% 50V
C3819	1-126-960-11	ELECT 1MF	20% 50V
C3822	1-136-165-00	MYLAR 0.1MF	5% 50V
		<CONNECTOR>	
CN3802*	1-564-507-11	PLUG, CONNECTOR 4P	
CN3803*	1-564-506-11	PLUG, CONNECTOR 3P	
		<DIODE>	
D3805	8-719-911-19	DIODE 1SS119-25	
D3805	8-719-991-33	DIODE 1SS133T-77	
		<IC>	
IC3805	8-759-822-38	IC LA6510	
IC3807	1-418-597-11	SENSOR UNIT, MAGNETIC	
		<TRANSISTOR>	
Q3807	8-729-030-02	TRANSISTOR DTC144ESA	
Q3808	8-729-030-02	TRANSISTOR DTC144ESA	
Q3809	8-729-119-78	TRANSISTOR 2SC2785-HFE	
Q3810	8-729-119-76	TRANSISTOR 2SA1175-HFE	
Q3811	8-729-119-78	TRANSISTOR 2SC2785-HFE	
Q3812	8-729-119-78	TRANSISTOR 2SC2785-HFE	
		<RESISTOR>	
R3802	1-249-417-11	CARBON 1K	5% 1/4W
R3803	1-249-417-11	CARBON 1K	5% 1/4W
R3804	1-215-444-00	METAL 9.1K	1% 1/4W
R3805	1-249-422-11	CARBON 2.7K	5% 1/4W
R3807	1-215-413-00	METAL 470	1% 1/4W
R3808	1-247-883-00	CARBON 150K	5% 1/4W
R3809	1-247-876-11	CARBON 75K	5% 1/4W
R3810	1-249-425-11	CARBON 4.7K	5% 1/4W
R3814	1-249-411-11	CARBON 330	5% 1/4W
R3823	1-249-395-11	CARBON 15	5% 1/4W
R3825	1-249-417-11	CARBON 1K	5% 1/4W
R3828	1-249-377-11	CARBON 0.47	5% 1/4W F
R3839	1-249-429-11	CARBON 10K	5% 1/4W
R3845	1-249-425-11	CARBON 4.7K	5% 1/4W
R3846	1-249-417-11	CARBON 1K	5% 1/4W
R3847	1-247-807-31	CARBON 100	5% 1/4W
R3848	1-249-417-11	CARBON 1K	5% 1/4W
R3849	1-249-377-11	CARBON 0.47	5% 1/4W F

The components identified by shading and mark Δ are critical for safety. Replace only with part number specified.



REF. NO.	PART NO.	DESCRIPTION	REMARK
R3852	1-249-441-11	CARBON 100K 5%	1/4W
R3854	1-249-429-11	CARBON 10K 5%	1/4W

* A-1241-405-A F BOARD MOUNTED *****			
1-533-223-11 CLIP, FUSE			
* 4-374-846-01 COVER, CAPACITOR, CAP TYPE			
<CAPACITOR>			
C654	Δ 1-117-703-11	CERAMIC 0.0047MF 99%	250V
C4601	Δ 1-104-708-11	MYLAR 0.47MF 20%	250V
C4602	Δ 1-109-835-11	MYLAR 0.68MF 20%	250V
<CONNECTOR>			
CN4601*	Δ 1-580-843-11	PIN, CONNECTOR (POWER)	
CN4602*	Δ 1-580-843-11	PIN, CONNECTOR (POWER)	
CN4603	1-695-915-11	TAB (CONTACT)	
<FUSE>			
F4601	Δ 1-532-299-00	FUSE, TIME-LAG 5A/250V	
<RESISTOR>			
R4601	Δ 1-202-719-00	SOLID 1M 10%	1/2W
<TRANSFORMER>			
T4601	Δ 1-431-536-11	TRANSFORMER, LINE FILTER	
T4602	Δ 1-431-182-11	TRANSFORMER, LINE FILTER	
<VARISTOR>			
VDR461	Δ 1-801-830-31	VARISTOR ERZV14D621	

* A-1372-739-A H1 BOARD MOUNTED *****			
* 4-055-304-01 HOLDER, LED			
<CAPACITOR>			
C1900	1-136-153-00	MYLAR 0.01MF 5%	50V
C1901	1-136-175-00	MYLAR 0.68MF 5%	50V
C1902	1-136-153-00	MYLAR 0.01MF 5%	50V
C1903	1-136-175-00	MYLAR 0.68MF 5%	50V
C1904	1-126-965-11	ELECT 22MF 20%	50V
C1905	1-102-824-00	CERAMIC 470PF 5%	50V
C1908	1-102-824-00	CERAMIC 470PF 5%	50V
C1910	1-104-664-11	ELECT 47MF 20%	16V

REF. NO.	PART NO.	DESCRIPTION	REMARK
C1911	1-104-664-11	ELECT 47MF	20% 16V
C1912	1-102-824-00	CERAMIC 470PF	5% 50V
C1913	1-126-960-11	ELECT 1MF	20% 50V
C1914	1-126-965-11	ELECT 22MF	20% 50V
<CONNECTOR>			
CN1601*	Δ 1-580-844-11	PIN, CONNECTOR (POWER)	
CN1602*	1-695-292-11	PIN, CONNECTOR (POWER)	
CN1901*	1-564-507-11	PLUG, CONNECTOR 4P	
CN1902*	1-564-507-11	PLUG, CONNECTOR 4P	
CN1903*	1-564-518-11	PLUG, CONNECTOR 3P	
CN1904*	1-564-509-11	PLUG, CONNECTOR 6P	
CN1905*	1-564-512-11	PLUG, CONNECTOR 9P	
CN1906*	1-564-507-11	PLUG, CONNECTOR 4P	
<DIODE>			
D1900	8-719-121-26	DIODE RD9.1ESL2	
D1901	8-719-121-26	DIODE RD9.1ESL2	
D1904	8-719-121-26	DIODE RD9.1ESL2	
D1905	8-719-121-26	DIODE RD9.1ESL2	
D1906	8-719-045-19	DIODE SPB-26MVWF	
D1907	8-719-121-26	DIODE RD9.1ESL2	
D1912	8-719-911-19	DIODE ISS119-25	
D1913	8-719-911-19	DIODE ISS119-25	
<IC>			
IC1901	8-742-134-00	HYB IC SBX1981-51P	
<JACK>			
J1901	1-770-786-11	JACK	
J1902	1-784-646-11	TERMINAL, S	
J1903	1-770-329-11	JACK, PIN 3P	
<COIL>			
L1901	1-408-603-31	INDUCTOR 10UH	
L1902	1-408-603-31	INDUCTOR 10UH	
L1903	1-416-857-11	INDUCTOR 65UH	
L1904	1-416-857-11	INDUCTOR 65UH	
<TRANSISTOR>			
Q1901	8-729-030-02	TRANSISTOR DTC144ESA	
Q1902	8-729-030-02	TRANSISTOR DTC144ESA	
<RESISTOR>			
R1900	1-249-411-11	CARBON 330	5% 1/4W
R1901	1-249-411-11	CARBON 330	5% 1/4W
R1902	1-247-804-11	CARBON 75	5% 1/4W
R1903	1-249-441-11	CARBON 100K	5% 1/4W
R1904	1-249-437-11	CARBON 47K	5% 1/4W

The components identified by shading and mark Δ are critical for safety. Replace only with part number specified.

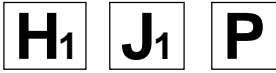

REF. NO.	PART NO.	DESCRIPTION	REMARK
R1905	1-249-437-11	CARBON 47K 5%	1/4W
R1906	1-249-441-11	CARBON 100K 5%	1/4W
R1908	1-249-413-11	CARBON 470 5%	1/4W
R1909	1-249-417-11	CARBON 1K 5%	1/4W
R1910	1-249-420-11	CARBON 1.8K 5%	1/4W
R1911	1-249-411-11	CARBON 330 5%	1/4W
R1912	1-247-843-11	CARBON 3.3K 5%	1/4W
R1913	1-249-429-11	CARBON 10K 5%	1/4W
R1914	1-249-411-11	CARBON 330 5%	1/4W
R1915	1-249-429-11	CARBON 10K 5%	1/4W
R1916	1-249-401-11	CARBON 47 5%	1/4W
R1917	1-247-804-11	CARBON 75 5%	1/4W
R1920	1-247-807-31	CARBON 100 5%	1/4W
R1921	1-247-807-31	CARBON 100 5%	1/4W
R1922	1-249-421-11	CARBON 2.2K 5%	1/4W
R1924	1-247-804-11	CARBON 75 5%	1/4W
R1925	1-215-381-00	METAL 22	1% 1/4W
R1926	1-215-381-00	METAL 22	1% 1/4W

<SWITCH>

S1601 Δ	1-571-433-21	SWITCH, PUSH (AC POWER)
S1902	1-692-431-21	SWITCH, TACTILE
S1903	1-692-431-21	SWITCH, TACTILE
S1904	1-692-431-21	SWITCH, TACTILE
S1905	1-692-431-21	SWITCH, TACTILE
S1906	1-692-431-21	SWITCH, TACTILE

* A-1388-269-A J1 BOARD MOUNTED

<CAPACITOR>

C2410	1-126-967-11	ELECT 47MF 20%	50V
C2411	1-126-967-11	ELECT 47MF 20%	50V
C2412	1-126-967-11	ELECT 47MF 20%	50V
C2413	1-102-112-00	CERAMIC 330PF 10%	50V
C2414	1-102-112-00	CERAMIC 330PF 10%	50V
C2418	1-126-960-11	ELECT 1MF 20%	50V
C2419	1-126-960-11	ELECT 1MF 20%	50V

<CONNECTOR>

CN2410*	1-564-523-11	PLUG, CONNECTOR 8P
---------	--------------	--------------------

<DIODE>

D2410	8-719-121-26	DIODE RD9.1ESL2
D2411	8-719-121-26	DIODE RD9.1ESL2
D2412	8-719-121-26	DIODE RD9.1ESL2
D2414	8-719-121-26	DIODE RD9.1ESL2
D2415	8-719-121-26	DIODE RD9.1ESL2

REF. NO.	PART NO.	DESCRIPTION	REMARK
		<JACK>	
J2410	1-784-623-11	BLOCK, PIN JACK 5P	
		<RESISTOR>	
R2410	1-247-804-11	CARBON 75 5%	1/4W
R2411	1-247-804-11	CARBON 75 5%	1/4W
R2412	1-247-804-11	CARBON 75 5%	1/4W
R2414	1-247-887-00	CARBON 220K 5%	1/4W
R2415	1-247-807-31	CARBON 100 5%	1/4W
R2417	1-247-887-00	CARBON 220K 5%	1/4W
R2418	1-247-807-31	CARBON 100 5%	1/4W
R2419	1-247-815-91	CARBON 220 5%	1/4W
R2420	1-247-815-91	CARBON 220 5%	1/4W
R2421	1-247-815-91	CARBON 220 5%	1/4W

* A-1195-158-A P BOARD COMPLETE

<CAPACITOR>

C9401	1-163-113-00	CERAMIC CHIP 68PF 5%	50V
C9402	1-163-038-91	CERAMIC CHIP 0.1MF	25V
C9404	1-164-346-11	CERAMIC CHIP 1MF	16V
C9405	1-163-021-91	CERAMIC CHIP 0.01MF 10%	50V
C9406	1-163-113-00	CERAMIC CHIP 68PF 5%	50V
C9408	1-115-419-11	CERAMIC CHIP 3300PF 5%	25V
C9409	1-115-185-11	CERAMIC CHIP 0.033MF 10%	50V
C9410	1-126-206-11	ELECT CHIP 100MF 20%	6.3V
C9412	1-162-569-11	CERAMIC CHIP 100PF 2%	50V
C9413	1-162-569-11	CERAMIC CHIP 100PF 2%	50V
C9414	1-162-569-11	CERAMIC CHIP 100PF 2%	50V
C9415	1-162-569-11	CERAMIC CHIP 100PF 2%	50V
C9420	1-163-263-11	CERAMIC CHIP 330PF 5%	50V
C9501	1-126-396-11	ELECT CHIP 47MF 20%	16V
C9502	1-163-038-91	CERAMIC CHIP 0.1MF	25V
C9503	1-126-396-11	ELECT CHIP 47MF 20%	16V
C9504	1-163-038-91	CERAMIC CHIP 0.1MF	25V
C9505	1-163-038-91	CERAMIC CHIP 0.1MF	25V
C9507	1-126-396-11	ELECT CHIP 47MF 20%	16V
C9508	1-163-038-91	CERAMIC CHIP 0.1MF	25V
C9509	1-126-204-11	ELECT CHIP 47MF 20%	16V
C9510	1-107-823-11	CERAMIC CHIP 0.47MF 10%	16V
C9511	1-104-760-11	CERAMIC CHIP 0.047MF 10%	50V
C9512	1-126-204-11	ELECT CHIP 47MF 20%	16V
C9513	1-163-038-91	CERAMIC CHIP 0.1MF	25V
C9514	1-163-038-91	CERAMIC CHIP 0.1MF	25V
C9515	1-104-601-11	ELECT CHIP 10MF 20%	10V
C9516	1-104-601-11	ELECT CHIP 10MF 20%	10V
C9517	1-104-601-11	ELECT CHIP 10MF 20%	10V
C9518	1-163-038-91	CERAMIC CHIP 0.1MF	25V
C9519	1-163-038-91	CERAMIC CHIP 0.1MF	25V
C9520	1-163-038-91	CERAMIC CHIP 0.1MF	25V

P

REF. NO.	PART NO.	DESCRIPTION	REMARK	REF. NO.	PART NO.	DESCRIPTION	REMARK
C9522	1-163-017-00	CERAMIC CHIP 0.0047MF	10% 50V	C9623	1-164-505-11	CERAMIC CHIP 2.2MF	16V
C9523	1-164-005-11	CERAMIC CHIP 0.47MF	16V	C9626	1-163-038-91	CERAMIC CHIP 0.1MF	25V
C9524	1-164-005-11	CERAMIC CHIP 0.47MF	16V	C9629	1-124-779-00	ELECT CHIP 10MF	20% 16V
C9525	1-163-038-91	CERAMIC CHIP 0.1MF	25V	C9801	1-126-204-11	ELECT CHIP 47MF	20% 16V
C9526	1-163-038-91	CERAMIC CHIP 0.1MF	25V	C9802	1-163-038-91	CERAMIC CHIP 0.1MF	25V
C9527	1-104-601-11	ELECT CHIP 10MF	20% 10V	C9803	1-126-204-11	ELECT CHIP 47MF	20% 16V
C9528	1-104-601-11	ELECT CHIP 10MF	20% 10V	C9804	1-163-038-91	CERAMIC CHIP 0.1MF	25V
C9529	1-104-601-11	ELECT CHIP 10MF	20% 10V	C9846	1-163-121-00	CERAMIC CHIP 150PF	5% 50V
C9530	1-163-038-91	CERAMIC CHIP 0.1MF	25V	C9847	1-163-121-00	CERAMIC CHIP 150PF	5% 50V
C9531	1-163-038-91	CERAMIC CHIP 0.1MF	25V	C9849	1-164-161-11	CERAMIC CHIP 0.0022MF	10% 50V
C9532	1-163-038-91	CERAMIC CHIP 0.1MF	25V	C9850	1-164-161-11	CERAMIC CHIP 0.0022MF	10% 50V
C9533	1-163-038-91	CERAMIC CHIP 0.1MF	25V	C9858	1-163-038-91	CERAMIC CHIP 0.1MF	25V
C9534	1-163-038-91	CERAMIC CHIP 0.1MF	25V	C9859	1-126-206-11	ELECT CHIP 100MF	20% 6.3V
C9535	1-126-396-11	ELECT CHIP 47MF	20% 16V	C9860	1-163-038-91	CERAMIC CHIP 0.1MF	25V
C9536	1-126-396-11	ELECT CHIP 47MF	20% 16V	C9883	1-163-038-91	CERAMIC CHIP 0.1MF	25V
C9537	1-107-823-11	CERAMIC CHIP 0.47MF	10% 16V	C9884	1-163-038-91	CERAMIC CHIP 0.1MF	25V
C9538	1-104-760-11	CERAMIC CHIP 0.047MF	10% 50V	C9885	1-126-396-11	ELECT CHIP 47MF	20% 16V
C9539	1-163-038-91	CERAMIC CHIP 0.1MF	25V	C9886	1-126-204-11	ELECT CHIP 47MF	20% 16V
C9540	1-163-038-91	CERAMIC CHIP 0.1MF	25V	C9889	1-126-396-11	ELECT CHIP 47MF	20% 16V
C9541	1-163-038-91	CERAMIC CHIP 0.1MF	25V	C9892	1-163-233-11	CERAMIC CHIP 18PF	5% 50V
C9542	1-163-038-91	CERAMIC CHIP 0.1MF	25V	C9893	1-163-231-11	CERAMIC CHIP 15PF	5% 50V
C9543	1-164-489-11	CERAMIC CHIP 0.22MF	10% 16V	C9894	1-126-204-11	ELECT CHIP 47MF	20% 16V
C9544	1-163-038-91	CERAMIC CHIP 0.1MF	25V			<CONNECTOR>	
C9545	1-163-038-91	CERAMIC CHIP 0.1MF	25V	CN9501	1-573-299-21	CONNECTOR, BOARD TO BOARD 10P	
C9546	1-163-038-91	CERAMIC CHIP 0.1MF	25V	CN9502	1-764-811-11	CONNECTOR, BOARD TO BOARD 10P	
C9547	1-163-038-91	CERAMIC CHIP 0.1MF	25V	CN9503	1-764-813-11	CONNECTOR, BOARD TO BOARD 12P	
C9548	1-163-038-91	CERAMIC CHIP 0.1MF	25V			<DIODE>	
C9549	1-163-038-91	CERAMIC CHIP 0.1MF	25V	D9504	8-719-025-33	DIODE 02CZ6.2-TE85L	
C9550	1-126-206-11	ELECT CHIP 100MF	20% 6.3V	D9505	8-719-025-33	DIODE 02CZ6.2-TE85L	
C9552	1-163-038-91	CERAMIC CHIP 0.1MF	25V	D9506	8-719-073-01	DIODE MA111-(K8).S0	
C9553	1-163-038-91	CERAMIC CHIP 0.1MF	25V			<FERRITE BEAD>	
C9554	1-126-204-11	ELECT CHIP 47MF	20% 16V	FB9501	1-414-233-22	INDUCTOR CHIP 0UH	
C9555	1-126-204-11	ELECT CHIP 47MF	20% 16V	FB9502	1-414-233-22	INDUCTOR CHIP 0UH	
C9556	1-104-760-11	CERAMIC CHIP 0.047MF	10% 50V			<FILTER>	
C9558	1-126-204-11	ELECT CHIP 47MF	20% 16V	FL9501	1-233-505-21	FILTER, LOW PASS	
C9560	1-163-038-91	CERAMIC CHIP 0.1MF	25V	FL9502	1-233-504-21	FILTER, LOW PASS	
C9561	1-163-038-91	CERAMIC CHIP 0.1MF	25V	FL9503	1-233-504-21	FILTER, LOW PASS	
C9562	1-163-038-91	CERAMIC CHIP 0.1MF	25V	FL9504	1-233-504-21	FILTER, LOW PASS	
C9563	1-163-038-91	CERAMIC CHIP 0.1MF	25V	FL9505	1-233-504-21	FILTER, LOW PASS	
C9564	1-163-038-91	CERAMIC CHIP 0.1MF	25V	FL9506	1-233-505-21	FILTER, LOW PASS	
C9565	1-163-038-91	CERAMIC CHIP 0.1MF	25V	FL9604	1-233-945-21	FILTER, LOW PASS	
C9566	1-163-038-91	CERAMIC CHIP 0.1MF	25V	FL9607	1-233-944-21	FILTER, LOW PASS	
C9567	1-126-204-11	ELECT CHIP 47MF	20% 16V	FL9608	1-233-944-21	FILTER, LOW PASS	
C9568	1-163-038-91	CERAMIC CHIP 0.1MF	25V			<IC>	
C9569	1-163-275-11	CERAMIC CHIP 0.001MF	5% 50V	IC9401	8-759-907-81	IC SN74LS221NS	
C9570	1-163-275-11	CERAMIC CHIP 0.001MF	5% 50V	IC9501	8-759-467-22	IC MSM548331TS-K	
C9574	1-126-206-11	ELECT CHIP 100MF	20% 6.3V	IC9502	8-759-467-22	IC MSM548331TS-K	
C9576	1-163-143-00	CERAMIC CHIP 0.0012MF	5% 50V	IC9503	8-759-295-09	IC TLC2932IPW	
C9577	1-163-021-91	CERAMIC CHIP 0.01MF	10% 50V	IC9504	8-759-295-09	IC TLC2932IPW	
C9578	1-163-021-91	CERAMIC CHIP 0.01MF	10% 50V				
C9579	1-163-021-91	CERAMIC CHIP 0.01MF	10% 50V				
C9580	1-163-243-11	CERAMIC CHIP 47PF	5% 50V				
C9581	1-164-346-11	CERAMIC CHIP 1MF	16V				
C9582	1-163-251-11	CERAMIC CHIP 100PF	5% 50V				
C9589	1-163-251-11	CERAMIC CHIP 100PF	5% 50V				
C9590	1-163-251-11	CERAMIC CHIP 100PF	5% 50V				
C9591	1-126-206-11	ELECT CHIP 100MF	20% 6.3V				
C9605	1-126-206-11	ELECT CHIP 100MF	20% 6.3V				



REF. NO.	PART NO.	DESCRIPTION	REMARK	REF. NO.	PART NO.	DESCRIPTION	REMARK
IC9505	8-759-295-09	IC TLC2932IPW		Q9505	8-729-230-49	TRANSISTOR 2SC2712-YG	
IC9506	8-752-392-55	IC CXD2079Q		Q9517	8-729-216-22	TRANSISTOR 2SA1162-G	
IC9509	8-759-424-27	IC MC74HC163AFEL		Q9519	8-729-216-22	TRANSISTOR 2SA1162-G	
IC9510	8-759-424-27	IC MC74HC163AFEL					
IC9511	8-759-298-38	IC SN74LS164NSR		Q9520	8-729-230-49	TRANSISTOR 2SC2712-YG	
				Q9521	8-729-230-49	TRANSISTOR 2SC2712-YG	
IC9525	8-759-352-91	IC PST9143NL		Q9522	8-729-230-49	TRANSISTOR 2SC2712-YG	
IC9526	8-759-527-74	IC M24C02-MN6T		Q9523	8-729-216-22	TRANSISTOR 2SA1162-G	
IC9527	8-752-904-39	IC CXP86332-018Q		Q9530	8-729-216-22	TRANSISTOR 2SA1162-G	
IC9530	8-759-485-79	IC TC7SET08FU(TE85L)					
IC9531	8-759-485-79	IC TC7SET08FU(TE85L)		Q9533	8-729-216-22	TRANSISTOR 2SA1162-G	
				Q9540	8-729-216-22	TRANSISTOR 2SA1162-G	
IC9532	8-759-485-79	IC TC7SET08FU(TE85L)		Q9552	8-729-230-49	TRANSISTOR 2SC2712-YG	
		<CHIP CONDUCTOR>		Q9553	8-729-230-49	TRANSISTOR 2SC2712-YG	
JR9401	1-216-295-91	SHORT	0	Q9554	8-729-230-49	TRANSISTOR 2SC2712-YG	
		<COIL>					
L9401	1-414-757-11	INDUCTOR	100UH			<RESISTOR>	
L9402	1-414-757-11	INDUCTOR	100UH				
L9501	1-414-754-11	INDUCTOR	10UH	R9401	1-216-041-00	RES,CHIP	470 5% 1/10W
L9502	1-414-757-11	INDUCTOR	100UH	R9402	1-216-057-00	RES,CHIP	2.2K 5% 1/10W
L9503	1-414-757-11	INDUCTOR	100UH	R9403	1-216-091-00	RES,CHIP	56K 5% 1/10W
				R9404	1-216-081-00	RES,CHIP	22K 5% 1/10W
L9504	1-414-754-11	INDUCTOR	10UH	R9405	1-216-079-00	RES,CHIP	18K 5% 1/10W
L9505	1-414-757-11	INDUCTOR	100UH				
L9506	1-414-757-11	INDUCTOR	100UH	R9407	1-216-049-91	RES,CHIP	1K 5% 1/10W
L9507	1-414-754-11	INDUCTOR	10UH	R9408	1-216-073-00	RES,CHIP	10K 5% 1/10W
L9508	1-412-006-31	INDUCTOR CHIP	10UH	R9409	1-216-041-00	RES,CHIP	470 5% 1/10W
				R9410	1-216-091-00	RES,CHIP	56K 5% 1/10W
L9509	1-414-757-11	INDUCTOR	100UH	R9411	1-216-057-00	RES,CHIP	2.2K 5% 1/10W
L9510	1-414-757-11	INDUCTOR	100UH				
L9511	1-414-754-11	INDUCTOR	10UH	R9412	1-216-049-91	RES,CHIP	1K 5% 1/10W
L9512	1-414-754-11	INDUCTOR	10UH	R9416	1-216-073-00	RES,CHIP	10K 5% 1/10W
L9513	1-412-006-31	INDUCTOR CHIP	10UH	R9417	1-216-079-00	RES,CHIP	18K 5% 1/10W
				R9418	1-216-049-91	RES,CHIP	1K 5% 1/10W
L9514	1-412-006-31	INDUCTOR CHIP	10UH	R9419	1-216-073-00	RES,CHIP	10K 5% 1/10W
L9515	1-414-754-11	INDUCTOR	10UH				
L9523	1-414-754-11	INDUCTOR	10UH	R9420	1-216-073-00	RES,CHIP	10K 5% 1/10W
L9531	1-414-754-11	INDUCTOR	10UH	R9421	1-216-049-91	RES,CHIP	1K 5% 1/10W
L9538	1-414-754-11	INDUCTOR	10UH	R9422	1-216-025-91	RES,CHIP	100 5% 1/10W
				R9424	1-216-025-91	RES,CHIP	100 5% 1/10W
L9539	1-414-754-11	INDUCTOR	10UH	R9427	1-216-049-91	RES,CHIP	1K 5% 1/10W
L9544	1-414-754-11	INDUCTOR	10UH				
L9545	1-414-752-11	INDUCTOR	2.2UH	R9428	1-216-025-91	RES,CHIP	100 5% 1/10W
L9605	1-414-757-11	INDUCTOR	100UH	R9429	1-208-800-11	METAL CHIP	5.6K 0.50% 1/10W
				R9430	1-216-067-00	RES,CHIP	5.6K 5% 1/10W
		<TRANSISTOR>		R9431	1-216-295-91	SHORT	0
Q9401	8-729-230-49	TRANSISTOR 2SC2712-YG		R9432	1-216-057-00	RES,CHIP	2.2K 5% 1/10W
Q9402	8-729-230-49	TRANSISTOR 2SC2712-YG					
Q9403	8-729-230-49	TRANSISTOR 2SC2712-YG		R9433	1-216-065-91	RES,CHIP	4.7K 5% 1/10W
Q9404	1-801-806-11	TRANSISTOR DTC144EKA-T146		R9435	1-216-061-00	RES,CHIP	3.3K 5% 1/10W
Q9405	8-729-230-49	TRANSISTOR 2SC2712-YG		R9436	1-216-025-91	RES,CHIP	100 5% 1/10W
				R9437	1-216-057-00	RES,CHIP	2.2K 5% 1/10W
Q9406	8-729-230-49	TRANSISTOR 2SC2712-YG		R9438	1-216-057-00	RES,CHIP	2.2K 5% 1/10W
Q9407	8-729-230-49	TRANSISTOR 2SC2712-YG					
Q9408	1-801-806-11	TRANSISTOR DTC144EKA-T146		R9439	1-216-057-00	RES,CHIP	2.2K 5% 1/10W
Q9410	8-729-216-22	TRANSISTOR 2SA1162-G		R9440	1-216-065-91	RES,CHIP	4.7K 5% 1/10W
Q9411	8-729-216-22	TRANSISTOR 2SA1162-G		R9441	1-216-025-91	RES,CHIP	100 5% 1/10W
				R9442	1-208-776-11	METAL CHIP	560 0.50% 1/10W
Q9501	1-801-806-11	TRANSISTOR DTC144EKA-T146		R9445	1-216-079-00	RES,CHIP	18K 5% 1/10W
Q9502	1-801-806-11	TRANSISTOR DTC144EKA-T146					
				R9446	1-216-083-00	RES,CHIP	27K 5% 1/10W
				R9447	1-208-798-11	METAL CHIP	4.7K 0.50% 1/10W
				R9448	1-216-079-00	RES,CHIP	18K 5% 1/10W



REF. NO.	PART NO.	DESCRIPTION			REMARK	REF. NO.	PART NO.	DESCRIPTION			REMARK
R9449	1-216-083-00	RES,CHIP	27K	5%	1/10W	R9540	1-216-085-00	RES,CHIP	33K	5%	1/10W
R9450	1-216-065-91	RES,CHIP	4.7K	5%	1/10W	R9541	1-216-061-00	RES,CHIP	3.3K	5%	1/10W
R9451	1-216-025-91	RES,CHIP	100	5%	1/10W	R9542	1-216-057-00	RES,CHIP	2.2K	5%	1/10W
R9452	1-216-025-91	RES,CHIP	100	5%	1/10W	R9543	1-216-041-00	RES,CHIP	470	5%	1/10W
R9453	1-216-295-91	SHORT	0			R9544	1-216-053-00	RES,CHIP	1.5K	5%	1/10W
R9455	1-216-049-91	RES,CHIP	1K	5%	1/10W	R9545	1-216-295-91	SHORT	0		
R9456	1-216-049-91	RES,CHIP	1K	5%	1/10W	R9546	1-216-061-00	RES,CHIP	3.3K	5%	1/10W
R9457	1-216-025-91	RES,CHIP	100	5%	1/10W	R9547	1-216-053-00	RES,CHIP	1.5K	5%	1/10W
R9458	1-216-025-91	RES,CHIP	100	5%	1/10W	R9548	1-216-051-00	RES,CHIP	1.2K	5%	1/10W
R9460	1-216-049-91	RES,CHIP	1K	5%	1/10W	R9549	1-216-117-00	RES,CHIP	680K	5%	1/10W
R9483	1-208-770-11	METAL CHIP	330	0.50%	1/10W	R9551	1-208-754-11	METAL CHIP	68	0.50%	1/10W
R9484	1-208-754-11	METAL CHIP	68	0.50%	1/10W	R9553	1-208-754-11	METAL CHIP	68	0.50%	1/10W
R9485	1-208-754-11	METAL CHIP	68	0.50%	1/10W	R9554	1-216-295-91	SHORT	0		
R9486	1-208-754-11	METAL CHIP	68	0.50%	1/10W	R9555	1-216-037-00	RES,CHIP	330	5%	1/10W
R9487	1-208-754-11	METAL CHIP	68	0.50%	1/10W	R9556	1-216-033-00	RES,CHIP	220	5%	1/10W
R9488	1-208-754-11	METAL CHIP	68	0.50%	1/10W	R9558	1-216-117-00	RES,CHIP	680K	5%	1/10W
R9491	1-208-754-11	METAL CHIP	68	0.50%	1/10W	R9559	1-216-295-91	SHORT	0		
R9492	1-208-754-11	METAL CHIP	68	0.50%	1/10W	R9560	1-216-049-91	RES,CHIP	1K	5%	1/10W
R9493	1-208-754-11	METAL CHIP	68	0.50%	1/10W	R9561	1-216-025-91	RES,CHIP	100	5%	1/10W
R9494	1-208-754-11	METAL CHIP	68	0.50%	1/10W	R9562	1-216-025-91	RES,CHIP	100	5%	1/10W
R9495	1-208-754-11	METAL CHIP	68	0.50%	1/10W	R9563	1-216-025-91	RES,CHIP	100	5%	1/10W
R9496	1-208-754-11	METAL CHIP	68	0.50%	1/10W	R9564	1-216-025-91	RES,CHIP	100	5%	1/10W
R9497	1-208-754-11	METAL CHIP	68	0.50%	1/10W	R9566	1-216-295-91	SHORT	0		
R9498	1-208-770-11	METAL CHIP	330	0.50%	1/10W	R9567	1-208-798-11	METAL CHIP	4.7K	0.50%	1/10W
R9501	1-216-061-00	RES,CHIP	3.3K	5%	1/10W	R9568	1-208-798-11	METAL CHIP	4.7K	0.50%	1/10W
R9502	1-216-051-00	RES,CHIP	1.2K	5%	1/10W	R9569	1-216-295-91	SHORT	0		
R9503	1-216-117-00	RES,CHIP	680K	5%	1/10W	R9570	1-216-295-91	SHORT	0		
R9504	1-216-041-00	RES,CHIP	470	5%	1/10W	R9571	1-216-295-91	SHORT	0		
R9505	1-216-295-91	SHORT	0			R9572	1-216-025-91	RES,CHIP	100	5%	1/10W
R9506	1-216-049-91	RES,CHIP	1K	5%	1/10W	R9573	1-216-073-00	RES,CHIP	10K	5%	1/10W
R9510	1-216-117-00	RES,CHIP	680K	5%	1/10W	R9574	1-216-073-00	RES,CHIP	10K	5%	1/10W
R9512	1-216-037-00	RES,CHIP	330	5%	1/10W	R9575	1-216-073-00	RES,CHIP	10K	5%	1/10W
R9513	1-216-073-00	RES,CHIP	10K	5%	1/10W	R9579	1-216-025-91	RES,CHIP	100	5%	1/10W
R9514	1-216-073-00	RES,CHIP	10K	5%	1/10W	R9580	1-216-025-91	RES,CHIP	100	5%	1/10W
R9515	1-216-033-00	RES,CHIP	220	5%	1/10W	R9581	1-216-033-00	RES,CHIP	220	5%	1/10W
R9517	1-216-295-91	SHORT	0			R9582	1-216-045-00	RES,CHIP	680	5%	1/10W
R9518	1-216-085-00	RES,CHIP	33K	5%	1/10W	R9584	1-216-295-91	SHORT	0		
R9519	1-216-295-91	SHORT	0			R9591	1-216-049-91	RES,CHIP	1K	5%	1/10W
R9520	1-216-057-00	RES,CHIP	2.2K	5%	1/10W	R9592	1-216-295-91	SHORT	0		
R9521	1-216-053-00	RES,CHIP	1.5K	5%	1/10W	R9593	1-216-295-91	SHORT	0		
R9522	1-216-053-00	RES,CHIP	1.5K	5%	1/10W	R9594	1-216-295-91	SHORT	0		
R9523	1-216-061-00	RES,CHIP	3.3K	5%	1/10W	R9595	1-216-295-91	SHORT	0		
R9524	1-216-061-00	RES,CHIP	3.3K	5%	1/10W	R9596	1-216-049-91	RES,CHIP	1K	5%	1/10W
R9525	1-216-085-00	RES,CHIP	33K	5%	1/10W	R9597	1-216-295-91	SHORT	0		
R9526	1-216-295-91	SHORT	0			R9598	1-216-295-91	SHORT	0		
R9528	1-216-295-91	SHORT	0			R9599	1-216-295-91	SHORT	0		
R9529	1-216-041-00	RES,CHIP	470	5%	1/10W	R9647	1-216-065-91	RES,CHIP	4.7K	5%	1/10W
R9530	1-216-051-00	RES,CHIP	1.2K	5%	1/10W	R9648	1-216-065-91	RES,CHIP	4.7K	5%	1/10W
R9531	1-216-117-00	RES,CHIP	680K	5%	1/10W	R9727	1-208-794-11	METAL CHIP	3.3K	0.50%	1/10W
R9532	1-216-061-00	RES,CHIP	3.3K	5%	1/10W	R9728	1-216-049-91	RES,CHIP	1K	5%	1/10W
R9533	1-208-798-11	METAL CHIP	4.7K	0.50%	1/10W	R9729	1-216-057-00	RES,CHIP	2.2K	5%	1/10W
R9534	1-208-774-11	METAL CHIP	470	0.50%	1/10W	R9733	1-216-057-00	RES,CHIP	2.2K	5%	1/10W
R9535	1-208-770-11	METAL CHIP	330	0.50%	1/10W	R9734	1-216-057-00	RES,CHIP	2.2K	5%	1/10W
R9536	1-208-770-11	METAL CHIP	330	0.50%	1/10W	R9735	1-208-762-11	METAL CHIP	150	0.50%	1/10W
R9537	1-208-770-11	METAL CHIP	330	0.50%	1/10W	R9742	1-208-762-11	METAL CHIP	150	0.50%	1/10W
R9538	1-208-782-11	METAL CHIP	1K	0.50%	1/10W	R9743	1-208-762-11	METAL CHIP	150	0.50%	1/10W
R9539	1-216-025-91	RES,CHIP	100	5%	1/10W	R9744	1-216-655-11	METAL CHIP	1.5K	0.50%	1/10W
						R9747	1-216-655-11	METAL CHIP	1.5K	0.50%	1/10W



REF. NO.	PART NO.	DESCRIPTION	REMARK
R9752	1-216-655-11	METAL CHIP	1.5K 0.50% 1/10W
R9753	1-216-025-91	RES,CHIP	100 5% 1/10W
R9772	1-216-025-91	RES,CHIP	100 5% 1/10W
R9773	1-216-295-91	SHORT	0
R9774	1-216-057-00	RES,CHIP	2.2K 5% 1/10W
R9782	1-216-049-91	RES,CHIP	1K 5% 1/10W
R9786	1-216-049-91	RES,CHIP	1K 5% 1/10W
R9801	1-216-295-91	SHORT	0
R9802	1-216-049-91	RES,CHIP	1K 5% 1/10W
R9803	1-216-049-91	RES,CHIP	1K 5% 1/10W
R9804	1-216-065-91	RES,CHIP	4.7K 5% 1/10W
R9805	1-216-073-00	RES,CHIP	10K 5% 1/10W
R9806	1-216-073-00	RES,CHIP	10K 5% 1/10W
R9807	1-216-049-91	RES,CHIP	1K 5% 1/10W
R9808	1-208-774-11	METAL CHIP	470 0.50% 1/10W
R9809	1-208-766-11	METAL CHIP	220 0.50% 1/10W
R9810	1-208-800-11	METAL CHIP	5.6K 0.50% 1/10W
R9811	1-216-065-91	RES,CHIP	4.7K 5% 1/10W
R9812	1-216-057-00	RES,CHIP	2.2K 5% 1/10W
R9813	1-216-057-00	RES,CHIP	2.2K 5% 1/10W
R9814	1-216-049-91	RES,CHIP	1K 5% 1/10W
R9815	1-216-049-91	RES,CHIP	1K 5% 1/10W
R9816	1-216-049-91	RES,CHIP	1K 5% 1/10W
R9817	1-216-049-91	RES,CHIP	1K 5% 1/10W
R9818	1-216-049-91	RES,CHIP	1K 5% 1/10W
R9819	1-216-049-91	RES,CHIP	1K 5% 1/10W
R9820	1-216-025-91	RES,CHIP	100 5% 1/10W
R9823	1-216-025-91	RES,CHIP	100 5% 1/10W
R9827	1-208-773-11	METAL CHIP	430 0.50% 1/10W
R9828	1-208-800-11	METAL CHIP	5.6K 0.50% 1/10W
R9829	1-216-049-91	RES,CHIP	1K 5% 1/10W
R9840	1-216-295-91	SHORT	0
R9842	1-208-774-11	METAL CHIP	470 0.50% 1/10W
R9843	1-208-766-11	METAL CHIP	220 0.50% 1/10W
R9849	1-208-800-11	METAL CHIP	5.6K 0.50% 1/10W
R9850	1-208-800-11	METAL CHIP	5.6K 0.50% 1/10W
R9851	1-208-800-11	METAL CHIP	5.6K 0.50% 1/10W
R9852	1-208-773-11	METAL CHIP	430 0.50% 1/10W
R9853	1-216-053-00	RES,CHIP	1.5K 5% 1/10W
R9854	1-216-053-00	RES,CHIP	1.5K 5% 1/10W
R9855	1-216-053-00	RES,CHIP	1.5K 5% 1/10W
R9864	1-208-776-11	METAL CHIP	560 0.50% 1/10W

<CRYSTAL>

X9504 1-781-174-21 VIBRATOR, CERAMIC
X9508 1-767-262-31 VIBRATOR, CRYSTAL

* A-1342-518-A VM2 BOARD MOUNTED

4-382-854-11 SCREW (M3X10), P, SW (+)

REF. NO.	PART NO.	DESCRIPTION	REMARK
		<CAPACITOR>	
C5900	1-102-115-00	CERAMIC	560PF 10% 50V
C5902	1-107-883-11	ELECT	330MF 20% 16V
C5903	1-161-830-00	CERAMIC	0.0047MF 500V
C5905	1-126-925-11	ELECT	470MF 20% 10V
C5906	1-130-491-00	MYLAR	0.047MF 5% 50V
C5907	1-107-638-11	ELECT	33MF 20% 160V
C5908	1-106-383-00	MYLAR	0.047MF 10% 200V
C5910	1-130-471-00	MYLAR	0.001MF 5% 50V
C5911	1-107-949-11	ELECT	2.2MF 20% 160V
C5912	1-104-999-11	MYLAR	0.1MF 10% 200V
C5913	1-130-471-00	MYLAR	0.001MF 5% 50V
C5914	1-126-933-11	ELECT	100MF 20% 16V
C5916	1-130-491-00	MYLAR	0.047MF 5% 50V
C5917	1-126-925-11	ELECT	470MF 20% 10V
C5919	1-130-471-00	MYLAR	0.001MF 5% 50V
C5921	1-101-880-00	CERAMIC	47PF 10% 50V
C5922	1-107-714-11	ELECT	10MF 20% 16V
		<CONNECTOR>	
CN2801*	1-564-506-11	PLUG, CONNECTOR 3P	
CN5901*	1-564-510-11	PLUG, CONNECTOR 7P	
CN5904*	1-770-723-11	CONNECTOR, BOARD TO BOARD 8P	
		<DIODE>	
D5901	8-719-911-19	DIODE 1SS119-25	
D5902	8-719-110-88	DIODE RD39ESB2	
D5904	8-719-110-88	DIODE RD39ESB2	
D5906	1-249-399-11	CARBON	33 5% 1/4W
D5907	1-249-399-11	CARBON	33 5% 1/4W
D5909	8-719-911-19	DIODE 1SS119-25	
D5910	8-719-911-19	DIODE 1SS119-25	
		<COIL>	
L5901	1-414-187-11	INDUCTOR	47UH
		<TRANSISTOR>	
Q5901	8-729-119-78	TRANSISTOR 2SC2785-HFE	
Q5902	8-729-809-26	TRANSISTOR 2SA1606-E	
Q5903	8-729-119-78	TRANSISTOR 2SC2785-HFE	
Q5904	8-729-119-76	TRANSISTOR 2SA1175-HFE	
Q5905	8-729-119-78	TRANSISTOR 2SC2785-HFE	
Q5906	8-729-809-29	TRANSISTOR 2SC4159-E	
Q5907	8-729-922-37	TRANSISTOR 2SD2144S-UVW	
Q5908	8-729-119-78	TRANSISTOR 2SC2785-HFE	
Q5909	8-729-119-78	TRANSISTOR 2SC2785-HFE	
		<RESISTOR>	
R5901	1-249-401-11	CARBON	47 5% 1/4W
R5902	1-249-414-11	CARBON	560 5% 1/4W F
R5903	1-247-731-11	CARBON	22 5% 1/2W F
R5904	1-249-408-11	CARBON	180 5% 1/4W
R5905	1-249-417-11	CARBON	1K 5% 1/4W

The components identified by shading and mark Δ are critical for safety. Replace only with part number specified.



REF. NO.	PART NO.	DESCRIPTION	REMARK
R5906	1-249-417-11	CARBON	1K 5% 1/4W
R5907	1-249-417-11	CARBON	1K 5% 1/4W
R5908	1-249-383-11	CARBON	1.5 5% 1/4W F
R5909	1-247-815-91	CARBON	220 5% 1/4W
R5910	1-249-403-11	CARBON	68 5% 1/4W
R5911	1-249-432-11	CARBON	18K 5% 1/4W
R5914	1-249-403-11	CARBON	68 5% 1/4W
R5917	1-249-418-11	CARBON	1.2K 5% 1/4W
R5918	1-249-429-11	CARBON	10K 5% 1/4W
R5919	1-249-417-11	CARBON	1K 5% 1/4W F
R5920	1-249-432-11	CARBON	18K 5% 1/4W
R5921	1-216-477-11	METAL OXIDE	270 5% 3W F
R5922	1-249-414-11	CARBON	560 5% 1/4W
R5923	1-249-383-11	CARBON	1.5 5% 1/4W F
R5924	1-249-397-11	CARBON	22 5% 1/4W F
R5925	1-249-397-11	CARBON	22 5% 1/4W F
R5927	1-249-416-11	CARBON	820 5% 1/4W
R5930	1-249-419-11	CARBON	1.5K 5% 1/4W
R5931	1-249-442-11	CARBON	510 5% 1/4W
R5932	1-249-437-11	CARBON	47K 5% 1/4W
R5933	1-249-417-11	CARBON	1K 5% 1/4W

MISCELLANEOUS

Δ 1-136-536-31	CAP, HIGH-VOLTAGE FILM 3000PF
1-251-658-21	SPLITTER RF
Δ 1-251-756-31	CAP ASSY, HIGH-VOLTAGE
Δ 1-416-757-11	COIL, DEMAGNETIC
Δ 1-416-871-11	COIL, LANDING CORRECTION
1-452-094-00	CIRCULAR DISC MAGNET B
1-452-032-00	MAGNET,DISC
1-452-896-61	COIL, NA ROTATION (RT-200)
1-505-473-11	SPEAKER (12CM)
Δ 1-467-525-21	CAP BLOCK, HIGH-VOLTAGE
1-505-474-11	SPEAKER (5CM)
* 1-555-110-00	P-P CABLE
Δ 1-574-062-11	CORD, POWER (WITH CONNECTOR) 2.5A/250V
1-771-360-11	SWITCH, TOP
Δ 8-451-499-11	DEFLECTION YOKE (Y34RSA-M)
8-453-007-31	NA324-M3
Δ 8-735-063-05	PICTURE TUBE (A80LPD10X)
8-742-166-00	HYB IC SBX3005-01

REF. NO.	PART NO.	DESCRIPTION	REMARK
		ACCESSORIES AND PACKING MATERIALS	

	3-701-910-00	SCREW, SPECIAL (DIA. 3.8X20)	
	3-868-057-11	MANUAL, INSTRUCTION	
	4-392-004-11	CLIP	
	4-392-003-11	BAND, HOLD	
	4-065-210-01	JOINT	
	* 4-068-629-01	CUSHION, (LOWER)(ASSY)	
	* 4-068-632-01	CUSHION, (UPPER)(ASSY)	
	* 4-072-970-01	INDIVIDUAL CARTON	
	* 4-072-972-01	BAG, PROTECTION	

		REMOTE COMMANDER	

	1-418-039-11	REMOTE COMMANDER (RM-951)	
	9-939-697-01	BATTERY COVER,REMOTE COMMANDER	

