



BOURNS®

Features

- Formerly **FulTec** brand
- Extremely high speed performance
- Blocks high voltages and currents
- Very high bandwidth; GHz compatible
- Small package, minimal PCB area
- Simple, superior circuit protection
- RoHS compliant*, UL Recognized



The C650 & C850 Series are currently available, but not recommended for new designs. Bourns® TBU-CA Series is preferred.

TBU® C650 and C850 Protectors

Transient Blocking Units - TBU® Devices

Bourns® C650 and C850 series products are high speed bidirectional protection components, constructed using MOSFET semiconductor technology, designed to protect against faults caused by short circuits, AC power cross, induction and lightning surges.

The TBU® high speed protector, triggering as a function of the MOSFET, blocks surges and provides an effective barrier behind which sensitive electronics are not exposed to large voltages or currents during surge events. The TBU® device is provided in a surface mount DFN package and meets industry standard requirements such as RoHS and Pb Free solder reflow profiles.

Agency Approval

UL recognized component File # E315805.

Industry Standards

Description			Model
Telcordia	GR-1089	Port Type 1, 3, 5	C650 C850
	GR-974		C650 C850
ITU-T	K.20, K.20E, K.21, K.21E, K.45		C850

Absolute Maximum Ratings (T_{amb} = 25 °C)

Symbol	Parameter		Value	Unit
V _{imp}	Maximum protection voltage for impulse faults with rise time ≥ 1 μsec	C650-xxx-WH C850-xxx-WH	650 850	V
V _{rms}	Maximum protection voltage for continuous V _{rms} faults	C650-xxx-WH C850-xxx-WH	300 425	V
T _{op}	Operating temperature range		-40 to +85	°C
T _{stg}	Storage temperature range		-65 to +150	°C

Electrical Characteristics (T_{amb} = 25 °C)

Symbol	Parameter		Min.	Typ.	Max.	Unit
I _{op}	Maximum current through the device that will not cause current blocking	Cx50-100-WH Cx50-180-WH Cx50-260-WH			100 180 260	mA
I _{trigger}	Typical current for the device to go from normal operating state to protected state	Cx50-100-WH Cx50-180-WH Cx50-260-WH		150 220 330		mA
I _{out}	Maximum current through the device	Cx50-100-WH Cx50-180-WH Cx50-260-WH			200 360 520	mA
R _{device}	Series resistance of the TBU® device	C650-100-WH C650-180-WH C650-260-WH C850-100-WH C850-180-WH C850-260-WH		12 8 8 17 11 11	14.5 10 10 19 14 14	Ω
t _{block}	Maximum time for the device to go from normal operating state to protected state				1	μs
I _{quiescent}	Current through the triggered TBU® device with 50 Vdc circuit voltage			1		mA
V _{reset}	Voltage below which the triggered TBU® device will transition to normal operating state			14		V

C650 and C850 TBU® protectors are bidirectional; specifications are valid in both directions.

*RoHS Directive 2002/95/EC Jan 27, 2003 including Annex.

Specifications are subject to change without notice.

Customers should verify actual device performance in their specific applications.

Applications

- Combo voice / xDSL linecards
- Voice linecards
- MDF, primary protection modules
- Process control equipment
- Test and measurement equipment
- General electronics

TBU® C650 and C850 Protectors

BOURNS®

Typical Performance Characteristics

V-I Characteristics

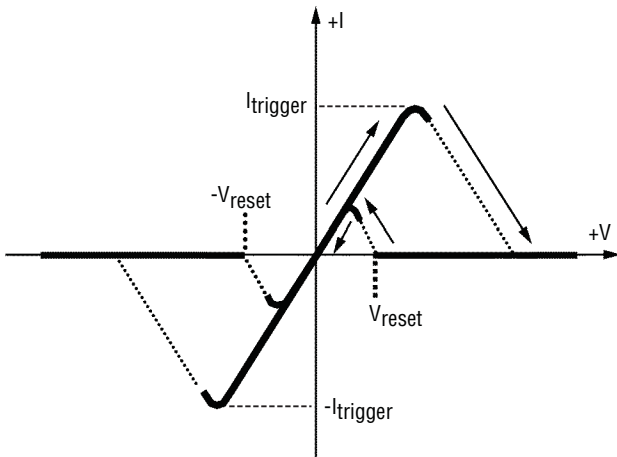

Time to Block vs. Fault Current

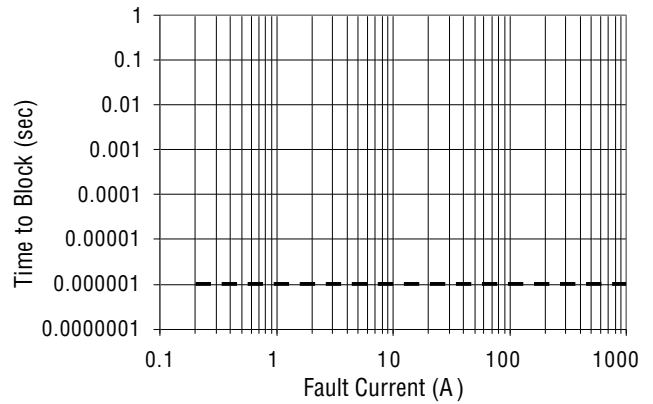

Current vs. Temperature

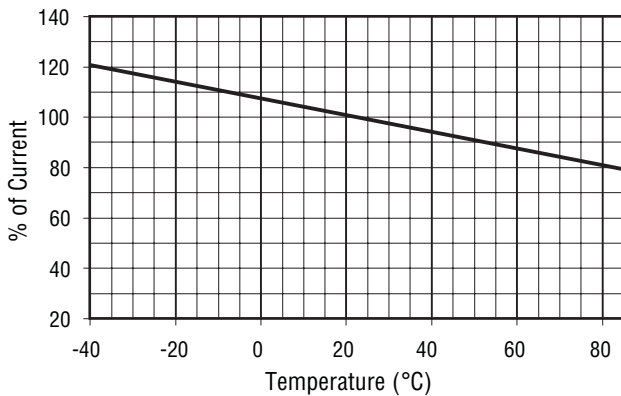

TBU® C650 and C850 Protectors

BOURNS®

Operational Characteristics

The graphs below demonstrate the operational characteristics of the TBU® protector. For each graph the fault voltage, protected side voltage, and current is presented.

TEST CONFIGURATION DIAGRAM

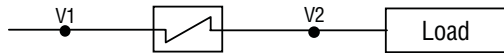

C650 Lightning, 650 V

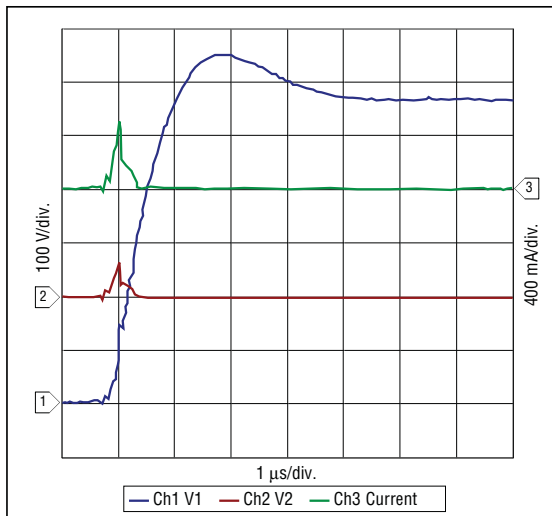

C850 Lightning, 850 V

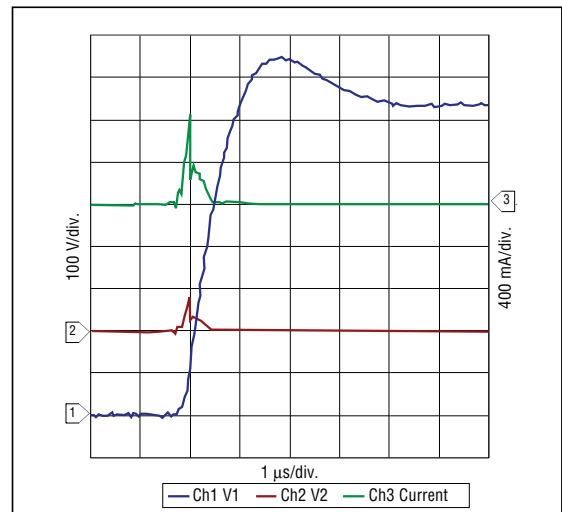

C650 Power Fault, 300 Vrms, 100 A

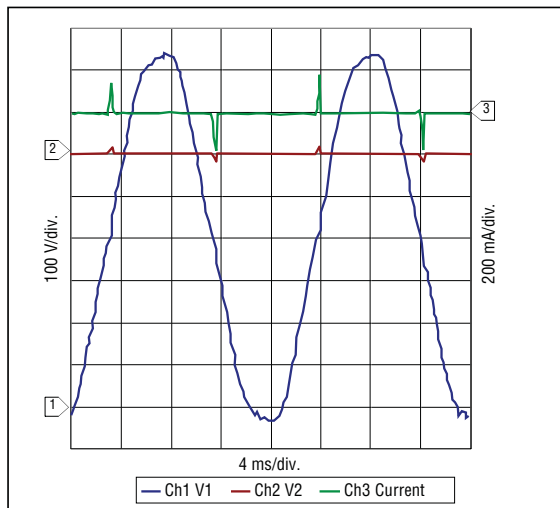

C850 Power Fault, 425 Vrms, 100 A

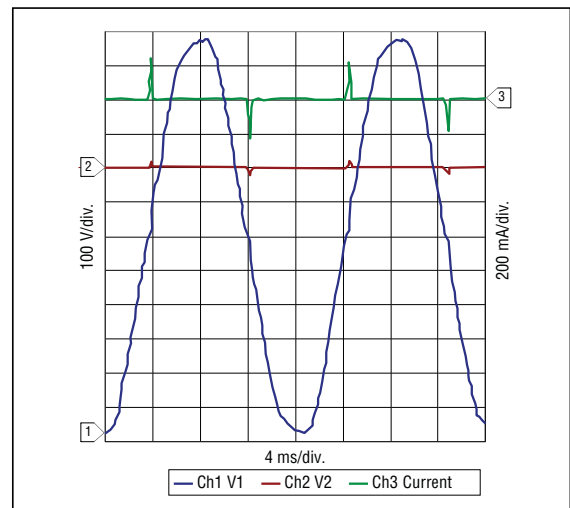

Product Dimensions

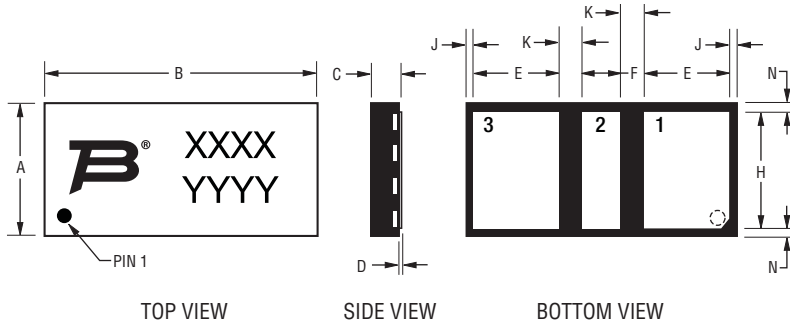

Dim.	Min.	Typ.	Max.
A	3.90 (.154)	4.00 (.157)	4.10 (.161)
B	8.15 (.321)	8.25 (.325)	8.35 (.329)
C	0.80 (.031)	0.85 (.033)	0.90 (.035)
D	0.000 (.000)	0.025 (.001)	0.050 (.002)
E	2.55 (.100)	2.60 (.102)	2.65 (.104)
F	1.10 (.043)	1.15 (.045)	1.20 (.047)
H	3.45 (.136)	3.50 (.138)	3.55 (.140)
J	0.20 (.008)	0.25 (.010)	0.30 (.012)
K	0.65 (.026)	0.70 (.028)	0.75 (.030)
N	0.20 (.008)	0.25 (.010)	0.30 (.012)

Recommended Pad Layout

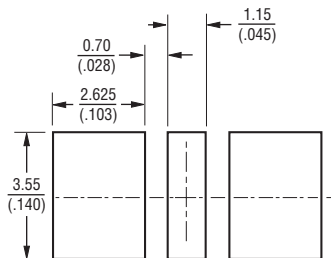

Pad Designation

Pad #	Apply
1	In/Out
2	NC
3	In/Out

NC = Solder to PCB; do not make electrical connection, do not connect to ground.

DIMENSIONS: $\frac{\text{MM}}{\text{(INCHES)}}$

TBU® protectors have matte-tin termination finish. Suggested layout should use non-solder mask define (NSMD). Recommended stencil thickness is 0.10-0.12 mm (.004-.005 in.) with stencil opening size 0.025 mm (.0010 in.) less than the device pad size. As when heat sinking any power device, it is recommended that, wherever possible, extra PCB copper area is allowed. For minimum parasitic capacitance, do not allow any signal, ground or power signals beneath any of the pads of the device.

Thermal Resistances

Symbol	Parameter	Value	Unit
$R_{th(j-a)}$	Junction to leads (package)	116	°C/W

Reflow Profile

Profile Feature	Pb-Free Assembly
Average Ramp-Up Rate (T _{smax} to T _p)	3 °C/sec. max.
Preheat <ul style="list-style-type: none"> - Temperature Min. (T_{smin}) - Temperature Max. (T_{smax}) - Time (t_{smin} to t_{smax}) 	150 °C 200 °C 60-180 sec.
Time maintained above: <ul style="list-style-type: none"> - Temperature (T_L) - Time (t_L) 	217 °C 60-150 sec.
Peak/Classification Temperature (T _p)	260 °C
Time within 5 °C of Actual Peak Temp. (t _p)	20-40 sec.
Ramp-Down Rate	6 °C/sec. max.
Time 25 °C to Peak Temperature	8 min. max.

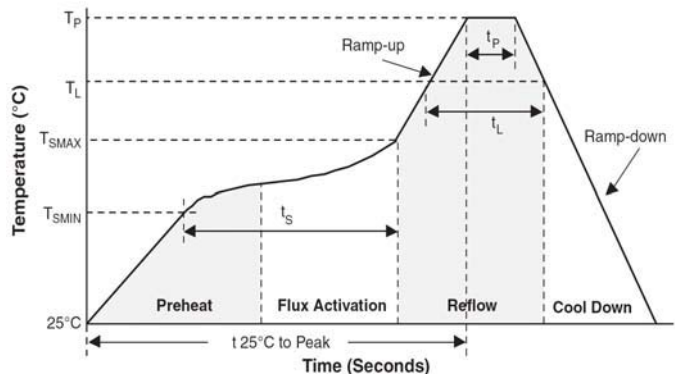

Specifications are subject to change without notice. Customers should verify actual device performance in their specific applications.

TBU® C650 and C850 Protectors



How to Order

C 650 - 180 - WH

Form Factor _____
 C = One TBU® protector in the device

Impulse Voltage Rating _____
 650 = 650 V
 850 = 850 V

lop Indicator _____
 100 = 100 mA
 180 = 180 mA
 260 = 260 mA

Typical Part Marking

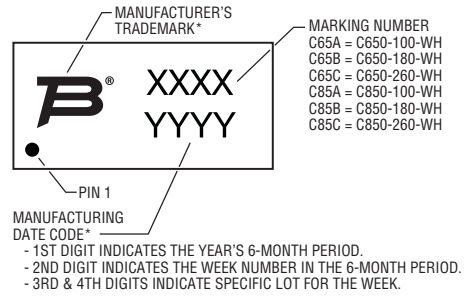

6-MONTH PERIOD CODES:
 A = JAN-JUN 2009 C = JAN-JUN 2010 E = JAN-JUN 2011
 B = JUL-DEC 2009 D = JUL-DEC 2010 F = JUL-DEC 2011

EXAMPLE: ARBC
 - 1ST DIGIT 'A' = JAN-JUN 2009
 - 2ND DIGIT 'R' = WEEK 18; WEEK OF APRIL 27
 - 3RD & 4TH DIGITS 'BC' = LOT SPECIFIC INFORMATION

*TRANSITION FROM FULTEC TRADEMARK AND LOT CODE TO BOURNS TRADEMARK AND DATE CODE IN 2009.

Packaging Specifications (per EIA468-B)

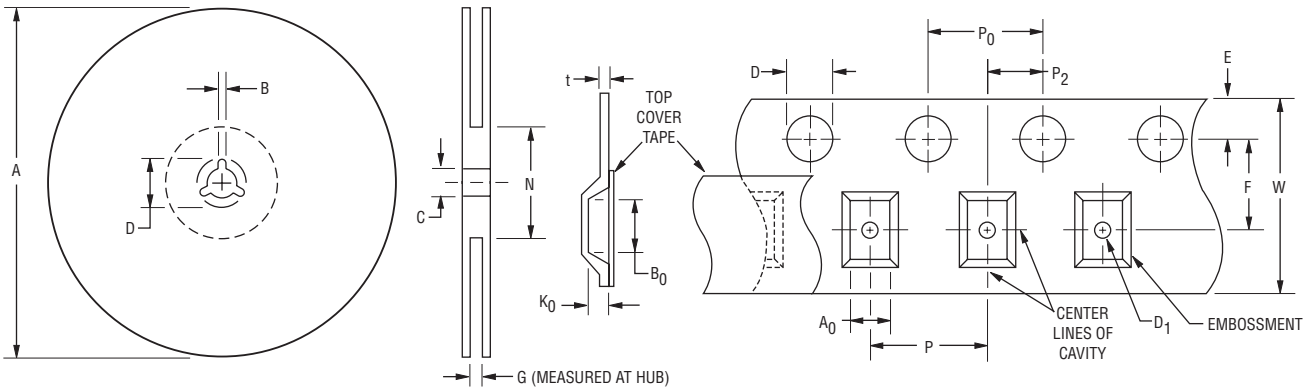

QUANTITY: 3000 PIECES PER REEL

Device	A		B		C		D		G	N
	Min.	Max.	Min.	Max.	Min.	Max.	Min.	Max.	Ref.	Ref.
C650, C850	326 (.165)	330.25 (13.002)	1.5 (.059)	2.5 (.098)	12.8 (.504)	13.5 (.531)	20.2 (.795)	-	16.5 (.650)	102 (4.016)

Device	A0		B0		D		D1		E		F	
	Min.	Max.	Min.	Max.	Min.	Max.	Min.	Max.	Min.	Max.	Min.	Max.
C650, C850	4.2 (.165)	4.4 (.173)	8.45 (.333)	8.65 (.341)	1.5 (.059)	1.6 (.063)	1.5 (.059)	-	1.65 (.065)	1.85 (.073)	7.4 (.291)	7.6 (.299)

Device	K0		P		P0		P2		t		W	
	Min.	Max.	Min.	Max.	Min.	Max.	Min.	Max.	Min.	Max.	Min.	Max.
C650, C850	1.1 (.043)	1.3 (.051)	7.9 (.311)	8.1 (.319)	3.9 (.159)	4.1 (.161)	1.9 (.075)	2.1 (.083)	0.25 (.010)	0.35 (.014)	15.7 (.618)	16.3 (.642)

DIMENSIONS: $\frac{\text{MM}}{\text{(INCHES)}}$

Specifications are subject to change without notice.
 Customers should verify actual device performance in their specific applications.

Reference Application

The C-series devices are general use protectors used in a wide variety of applications. The following diagram is one common configuration example of C-series device placement. A cost-effective protection solution combines Bourns® TBU® protection devices with a pair of MOVs or Bourns® GDTs. The figure below demonstrates the operational characteristics of the circuit.

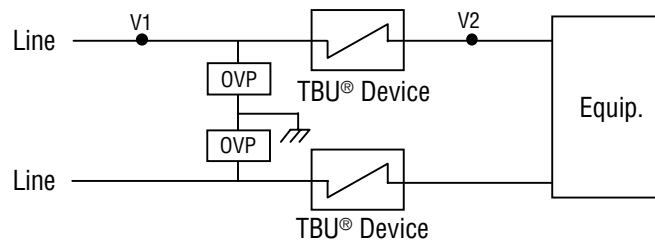

Common Configuration Diagram

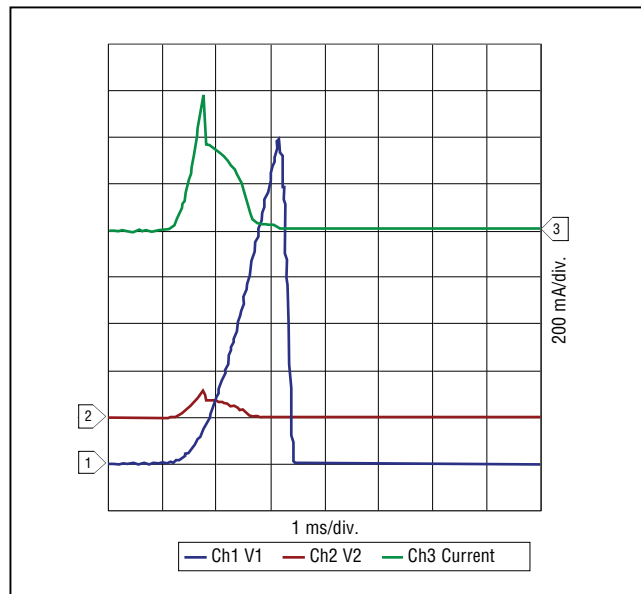

C850 with G5200AS 4000 V Lightning 10/700 μ sec, 150 A

BOURNS®

Asia-Pacific: Tel: +886-2 2562-4117 • Fax: +886-2 2562-4116

Europe: Tel: +41-41 768 5555 • Fax: +41-41 768 5510

The Americas: Tel: +1-951 781-5500 • Fax: +1-951 781-5700

www.bourns.com