

General Description

This planar stripe MOSFET has better characteristics, such as fast switching time, low on resistance, low gate charge and excellent avalanche characteristics. It is mainly suitable for electronic ballast and switching mode power supplies.

FEATURES

- $V_{DSS(\text{Min.})} = 400\text{V}$, $I_D = 10.5\text{A}$
- Drain-Source ON Resistance :
 $R_{DS(\text{ON})} = 0.53 \Omega$ @ $V_{GS} = 10\text{V}$
- $Q_g(\text{typ.}) = 32.5\text{nC}$

MAXIMUM RATING (Tc=25 °C)

CHARACTERISTIC	SYMBOL	RATING		UNIT	
		KHB011N40P1	KHB011N40F1		
Drain-Source Voltage	V_{DSS}	400		V	
Gate-Source Voltage	V_{GSS}	± 30		V	
Drain Current	@ $T_C = 25^\circ\text{C}$	I_D	10.5	10.5*	A
	@ $T_C = 100^\circ\text{C}$		6.6	6.6*	
	Pulsed (Note 1)	I_{DP}	42	42*	
Single Pulsed Avalanche Energy (Note 2)	E_{AS}	360		mJ	
Repetitive Avalanche Energy (Note 1)	E_{AR}	13.5		mJ	
Peak Diode Recovery dv/dt (Note 3)	dv/dt	4.5		V/ns	
Drain Power Dissipation	$T_C = 25^\circ\text{C}$	P_D	135	44	W
	Derate above 25°C		1.07	0.35	W/°C
Maximum Junction Temperature	T_j	150		°C	
Storage Temperature Range	T_{stg}	-55 ~ 150		°C	
Thermal Characteristics					
Thermal Resistance, Junction-to-Case	R_{thJC}	0.93	2.86	°C/W	
Thermal Resistance, Case-to-Sink	R_{thCS}	0.5	-	°C/W	
Thermal Resistance, Junction-to-Ambient	R_{thJA}	62.5	62.5	°C/W	

* : Drain current limited by maximum junction temperature.

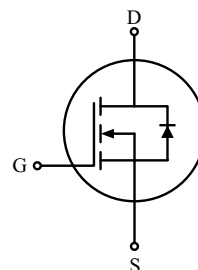
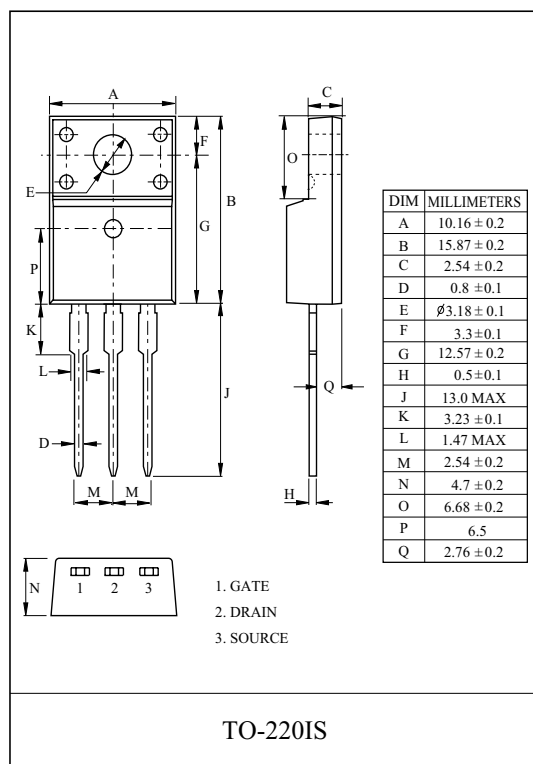
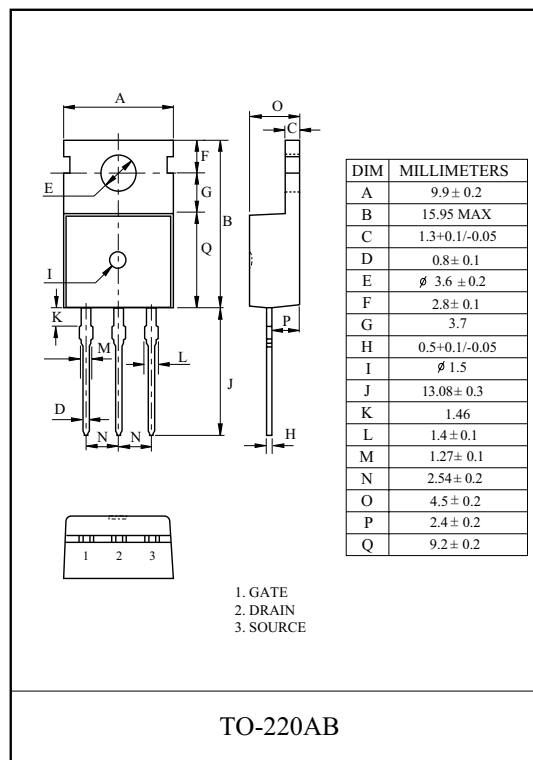

KHB011N40P1/F1

ELECTRICAL CHARACTERISTICS (Tc=25 °C)

CHARACTERISTIC	SYMBOL	TEST CONDITION	MIN.	TYP.	MAX.	UNIT
Static						
Drain-Source Breakdown Voltage	BV_{DSS}	$I_D=250\mu A, V_{GS}=0V$	400	-	-	V
Breakdown Voltage Temperature Coefficient	$\Delta BV_{DSS}/\Delta T_j$	$I_D=250\mu A$, Referenced to 25 °C	-	0.54	-	V/°C
Drain Cut-off Current	I_{DSS}	$V_{DS}=400V, V_{GS}=0V$,	-	-	10	μA
Gate Threshold Voltage	V_{th}	$V_{DS}=V_{GS}, I_D=250\mu A$	2.0	-	4.0	V
Gate Leakage Current	I_{GSS}	$V_{GS}=\pm 30V, V_{DS}=0V$	-	-	± 100	nA
Drain-Source ON Resistance	$R_{DS(ON)}$	$V_{GS}=10V, I_D=5.25A$	-	0.5	0.53	Ω
Dynamic						
Total Gate Charge	Q_g	$V_{DS}=320V, I_D=10.5A$ $V_{GS}=10V$ (Note4,5)	-	32.5	37.5	nC
Gate-Source Charge	Q_{gs}		-	6.4	-	
Gate-Drain Charge	Q_{gd}		-	13	-	
Turn-on Delay time	$t_{d(on)}$	$V_{DD}=200V$ $R_L=20\Omega$ $R_G=25\Omega$ (Note4,5)	-	23	45	ns
Turn-on Rise time	t_r		-	65	140	
Turn-off Delay time	$t_{d(off)}$		-	138	235	
Turn-off Fall time	t_f		-	81	170	
Input Capacitance	C_{iss}	$V_{DS}=25V, V_{GS}=0V, f=1.0MHz$	-	1472	1913	pF
Reverse Transfer Capacitance	C_{riss}		-	168	218	
Output Capacitance	C_{oss}		-	18.9	24.5	
Source-Drain Diode Ratings						
Continuous Source Current	I_S	$V_{GS}<V_{th}$	-	-	10.5	A
Pulsed Source Current	I_{SP}		-	-	42	
Diode Forward Voltage	V_{SD}	$I_S=10.5A, V_{GS}=0V$	-	-	1.5	V
Reverse Recovery Time	t_{rr}	$I_S=10.5A, V_{GS}=0V$, $dI_S/dt=100A/\mu s$	-	355	-	ns
Reverse Recovery Charge	Q_{rr}		-	4.0	-	μC

Note 1) Repetivity rating : Pulse width limited by junction temperature.

Note 2) $L = 5.7mH, I_S=10.5A, V_{DD}=50V, R_G = 25\Omega$, Starting $T_j = 25\text{ }^\circ\text{C}$.

Note 3) $I_S \leq 10.5A, dI/dt \leq 200A/\mu s, V_{DD} \leq BV_{DSS}$, Starting $T_j = 25\text{ }^\circ\text{C}$.

Note 4) Pulse Test : Pulse width $\leq 300\mu s$, Duty Cycle $\leq 2\%$.

Note 5) Essentially independent of operating temperature.

KHB011N40P1/F1

$I_D - V_{DS}$

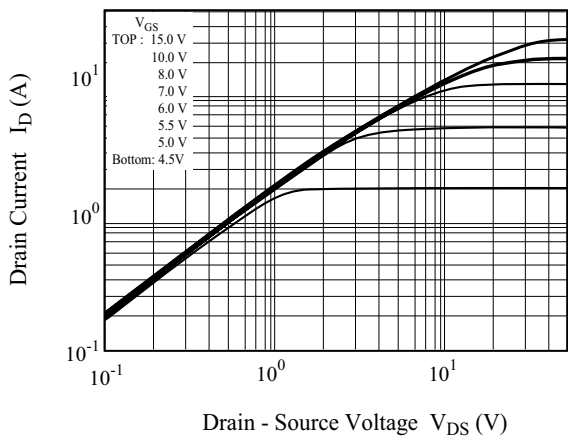

$I_D - V_{GS}$

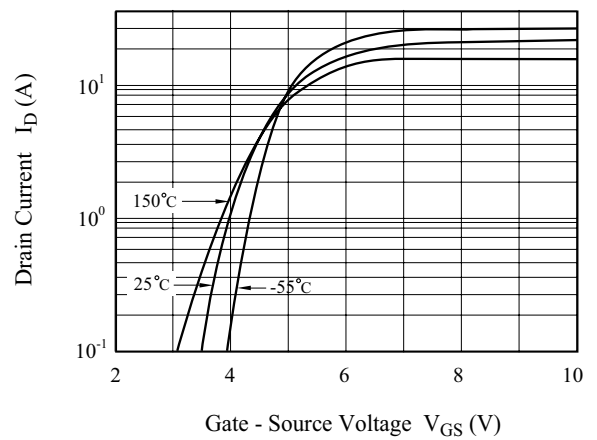

$BV_{DSS} - T_j$

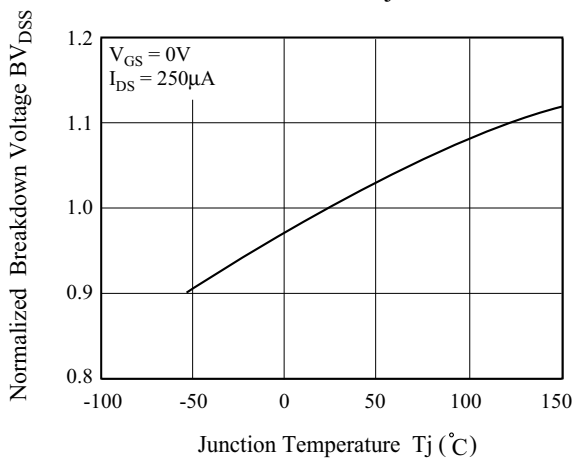

$R_{DS(ON)} - I_D$

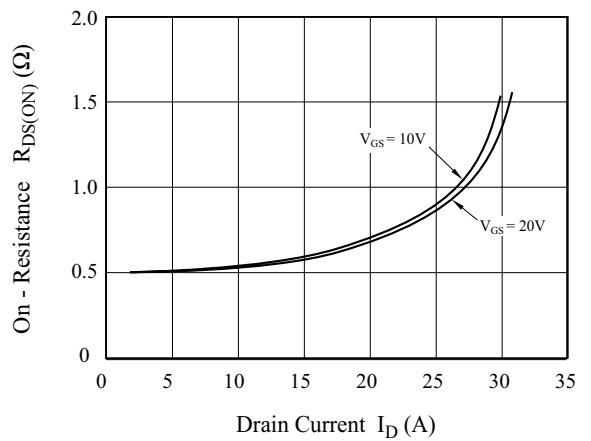

$I_S - V_{SD}$

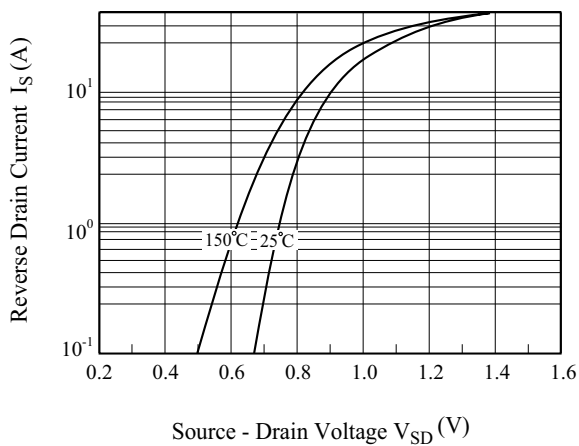

$R_{DS(ON)} - T_j$

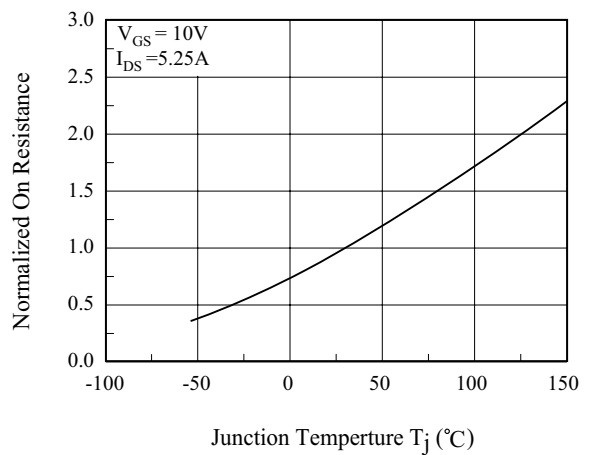

KHB011N40P1/F1

C - V_{DS}

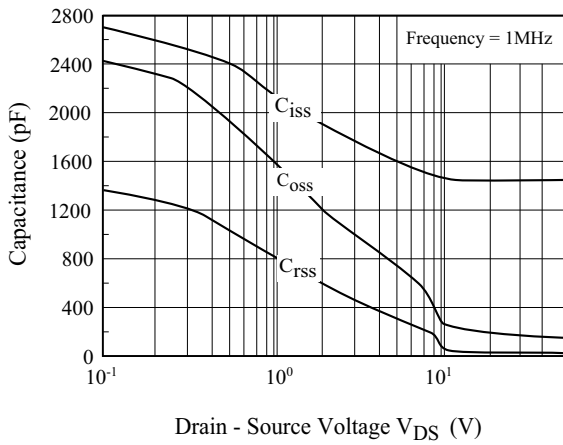

Q_g- V_{GS}

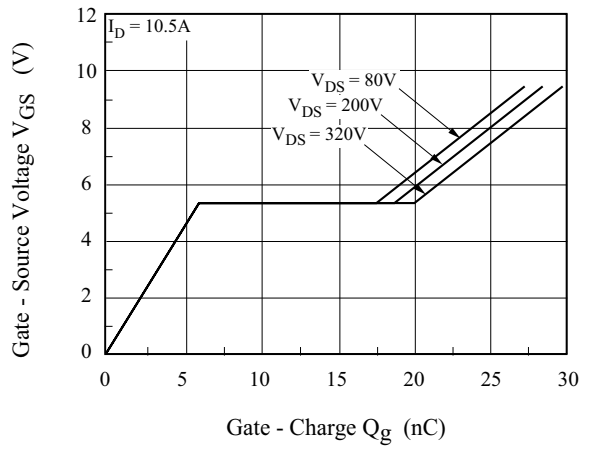

Safe Operation Area

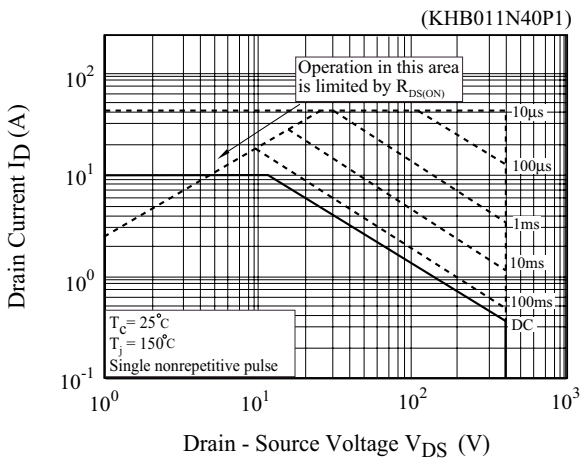

Safe Operation Area

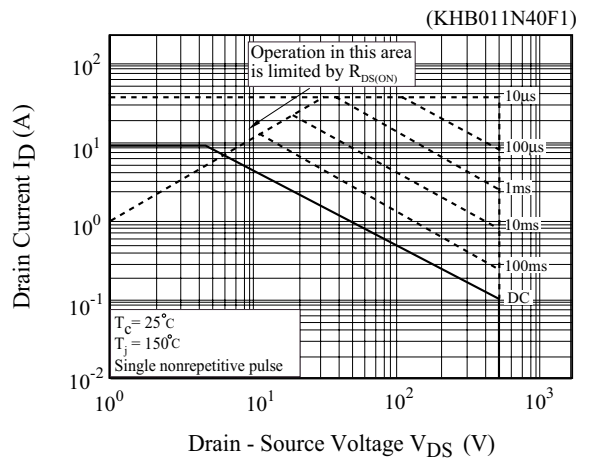

I_D - T_j

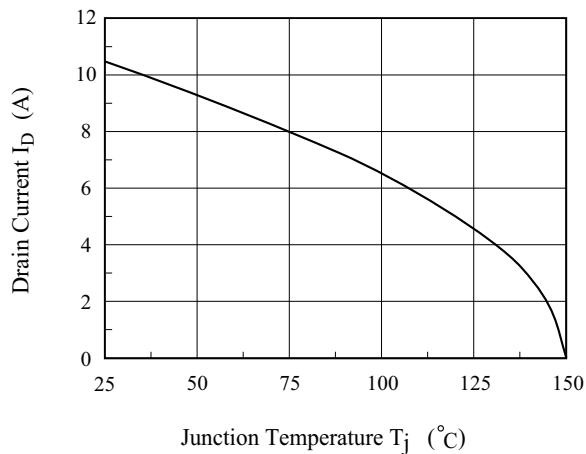

KHB011N40P1/F1

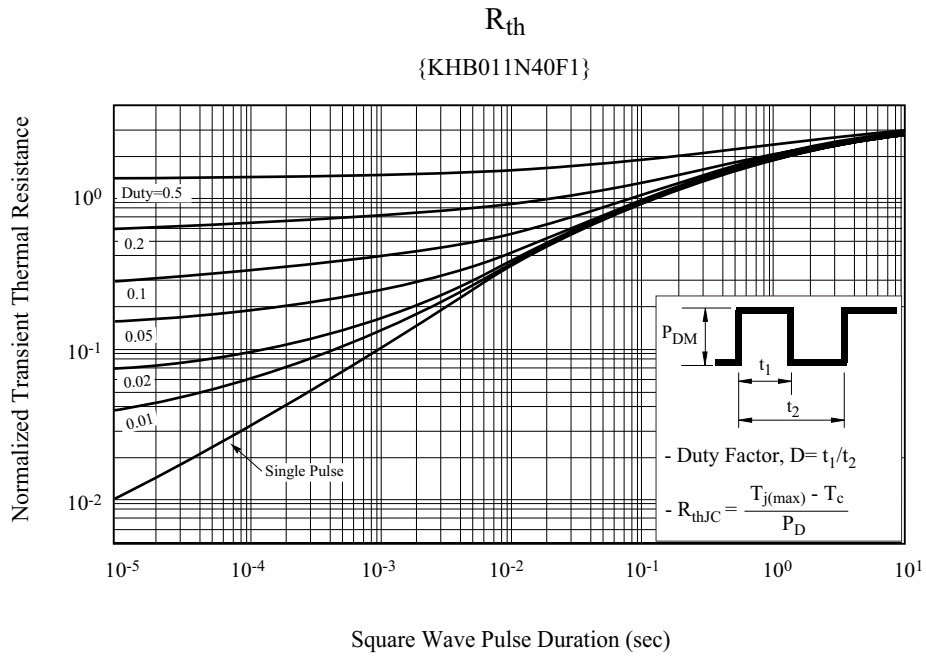
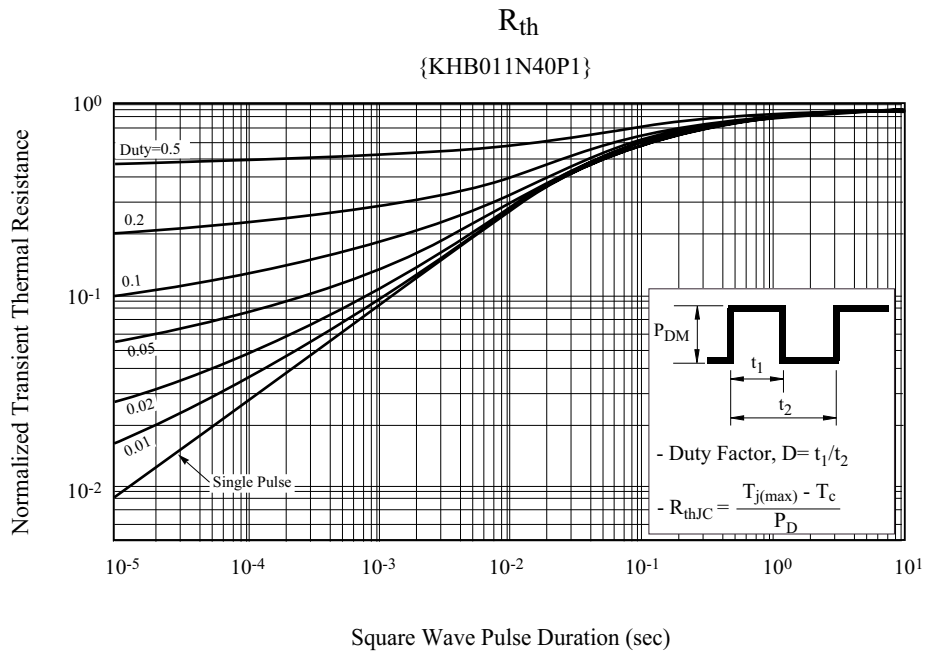

KHB011N40P1/F1

- Gate Charge

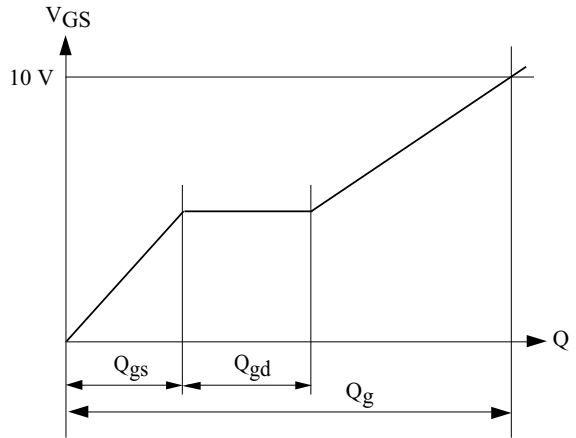
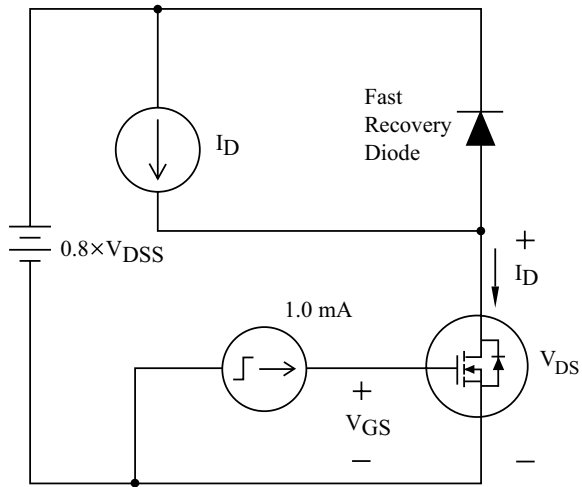

- Single Pulsed Avalanche Energy

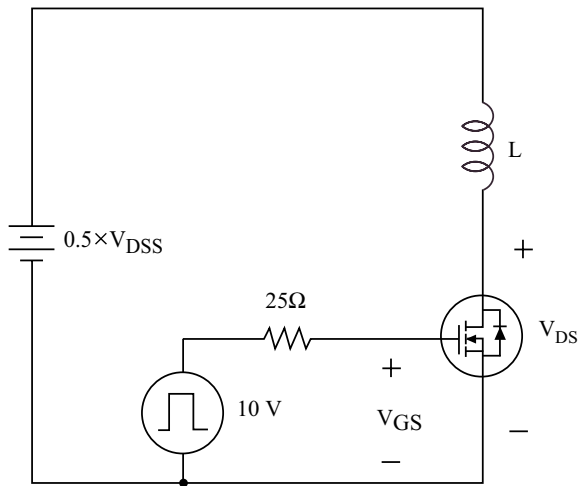

$$E_{AS} = \frac{1}{2} I_{AS}^2 \frac{BV_{DSS}}{BV_{DSS} - V_{DD}}$$

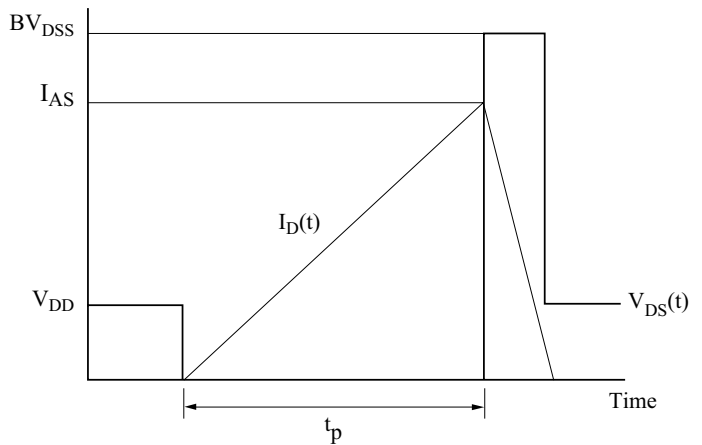

- Resistive Load Switching

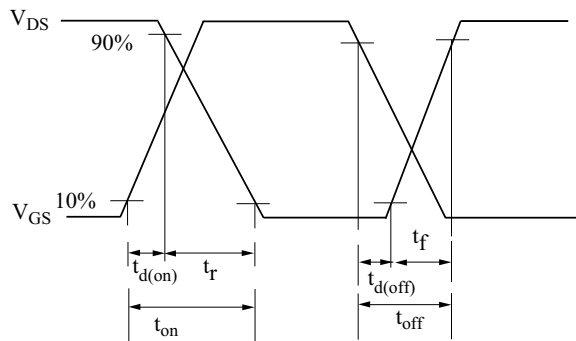
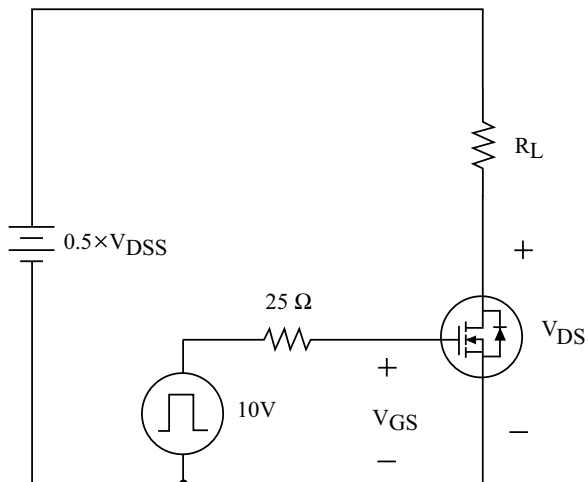

KHB011N40P1/F1

- Source - Drain Diode Reverse Recovery and dv/dt

