

COMPLEMENTARY NPN / PNP SMALL SIGNAL SURFACE MOUNT TRANSISTOR

Features

- Complementary Pair
- One 4124-Type NPN,
One 4126-Type PNP
- Epitaxial Planar Die Construction
- Ideal for Medium Power Amplification and Switching
- Ultra-Small Surface Mount Package
- Also Available in Lead Free Version

Mechanical Data

- Case: SOT-363, Molded Plastic
- Case Material - UL Flammability Rating 94V-0
- Moisture sensitivity: Level 1 per J-STD-020A
- Terminals: Solderable per MIL-STD-202, Method 208
- Also Available in Lead Free Plating (Matte Tin Finish). Please see Ordering Information, Note 5, on Page 2
- Terminal Connections: See Diagram
- Marking (See Page 3): K12
- Ordering & Date Code Information: See Pages 2 & 3
- Weight: 0.006 grams (approx.)

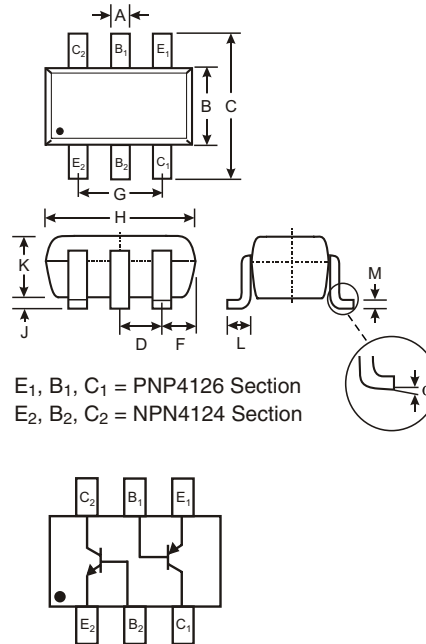

SOT-363		
Dim	Min	Max
A	0.10	0.30
B	1.15	1.35
C	2.00	2.20
D	0.65 Nominal	
F	0.30	0.40
H	1.80	2.20
J	—	0.10
K	0.90	1.00
L	0.25	0.40
M	0.10	0.25
α	0°	8°
All Dimensions in mm		

Maximum Ratings, NPN 4124 Section @ $T_A = 25^\circ\text{C}$ unless otherwise specified

Characteristic	Symbol	NPN 4124 Section	Unit
Collector-Base Voltage	V_{CBO}	30	V
Collector-Emitter Voltage	V_{CEO}	25	V
Emitter-Base Voltage	V_{EBO}	5.0	V
Collector Current - Continuous (Note 1)	I_C	200	mA
Power Dissipation (Note 1, 2)	P_d	200	mW
Thermal Resistance, Junction to Ambient (Note 1)	$R_{\theta JA}$	625	$^\circ\text{C/W}$

Maximum Ratings, PNP 4126 Section @ $T_A = 25^\circ\text{C}$ unless otherwise specified

Characteristic	Symbol	PNP 4126 Section	Unit
Collector-Base Voltage	V_{CBO}	-25	V
Collector-Emitter Voltage	V_{CEO}	-25	V
Emitter-Base Voltage	V_{EBO}	-4	V
Collector Current - Continuous (Note 1)	I_C	-200	mA
Power Dissipation (Note 1, 2)	P_d	200	mW
Thermal Resistance, Junction to Ambient (Note 1)	$R_{\theta JA}$	625	$^\circ\text{C/W}$

- Notes:
1. Device mounted on FR-4 PCB, 1 inch x 0.85 inch x 0.062 inch; pad layout as shown on Diodes Inc. suggested pad layout document AP02001, which can be found on our website at <http://www.diodes.com/datasheets/ap02001.pdf>.
 2. Maximum combined dissipation.

Electrical Characteristics, NPN 4124 Section

 @ T_A = 25°C unless otherwise specified

Characteristic	Symbol	Min	Max	Unit	Test Condition
OFF CHARACTERISTICS (Note 3)					
Collector-Base Breakdown Voltage	V _{(BR)CBO}	30	—	V	I _C = 10μA, I _E = 0
Collector-Emitter Breakdown Voltage	V _{(BR)CEO}	25	—	V	I _C = 1.0mA, I _B = 0
Emitter-Base Breakdown Voltage	V _{(BR)EBO}	5.0	6.0	V	I _E = 10μA, I _C = 0
Collector Cutoff Current	I _{CBO}	—	50	nA	V _{CB} = 20V, I _E = 0V
Emitter Cutoff Current	I _{EBO}	—	50	nA	V _{EB} = 3.0V, I _C = 0V
ON CHARACTERISTICS (Note 3)					
DC Current Gain	h _{FE}	120 60	360 —	—	I _C = 2.0mA, V _{CE} = 1.0V I _C = 50mA, V _{CE} = 1.0V
Collector-Emitter Saturation Voltage	V _{CE(SAT)}	—	0.30	V	I _C = 50mA, I _B = 5.0mA
Base-Emitter Saturation Voltage	V _{BE(SAT)}	—	0.95	V	I _C = 50mA, I _B = 5.0mA
SMALL SIGNAL CHARACTERISTICS					
Output Capacitance	C _{obo}	—	4.0	pF	V _{CB} = 5.0V, f = 1.0MHz, I _E = 0
Input Capacitance	C _{ibo}	—	8.0	pF	V _{EB} = 0.5V, f = 1.0MHz, I _C = 0
Small Signal Current Gain	h _{fe}	120	480	—	V _{CE} = 1.0V, I _C = 2.0mA, f = 1.0kHz
Current Gain-Bandwidth Product	f _T	300	—	MHz	V _{CE} = 20V, I _C = 10mA, f = 100MHz

Electrical Characteristics, PNP 4126 Section

 @ T_A = 25°C unless otherwise specified

Characteristic	Symbol	Min	Max	Unit	Test Condition
OFF CHARACTERISTICS (Note 3)					
Collector-Base Breakdown Voltage	V _{(BR)CBO}	-25	—	V	I _C = -10μA, I _E = 0
Collector-Emitter Breakdown Voltage	V _{(BR)CEO}	-25	—	V	I _C = -1.0mA, I _B = 0
Emitter-Base Breakdown Voltage	V _{(BR)EBO}	-4.0	—	V	I _E = -10μA, I _C = 0
Collector Cutoff Current	I _{CBO}	—	-50	nA	V _{CB} = -20V, I _E = 0V
Emitter Cutoff Current	I _{EBO}	—	-50	nA	V _{EB} = -3.0V, I _C = 0V
ON CHARACTERISTICS (Note 3)					
DC Current Gain	h _{FE}	120 60	360 —	—	I _C = -2.0mA, V _{CE} = -1.0V I _C = -50mA, V _{CE} = -1.0V
Collector-Emitter Saturation Voltage	V _{CE(SAT)}	—	-0.40	V	I _C = -50mA, I _B = -5.0mA
Base-Emitter Saturation Voltage	V _{BE(SAT)}	—	-0.95	V	I _C = -50mA, I _B = -5.0mA
SMALL SIGNAL CHARACTERISTICS					
Output Capacitance	C _{obo}	—	4.5	pF	V _{CB} = -5.0V, f = 1.0MHz, I _E = 0
Input Capacitance	C _{ibo}	—	10	pF	V _{EB} = -0.5V, f = 1.0MHz, I _C = 0
Small Signal Current Gain	h _{fe}	120	480	—	V _{CE} = -1.0V, I _C = -2.0mA, f = 1.0kHz
Current Gain-Bandwidth Product	f _T	250	—	MHz	V _{CE} = -20V, I _C = -10mA, f = 100MHz
Noise Figure	NF	—	4.0	dB	V _{CE} = -5.0V, I _C = -100μA, R _S = 1.0kΩ, f = 1.0kHz

Ordering Information (Note 4)

Device	Packaging	Shipping
MMDT4146-7	SOT-363	3000/Tape & Reel

- Notes:
3. Short duration test pulse used to minimize self-heating effect.
 4. For Packaging Details, go to our website at <http://www.diodes.com/datasheets/ap02007.pdf>.
 5. For Lead Free version (with Lead Free terminal finish) part number, please add "-F" suffix to part number above.
Example: MMDT4146-7-F.

Marking Information

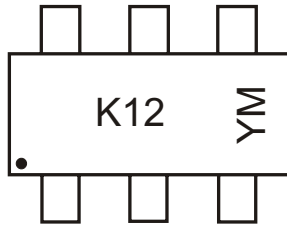

K12= Product Type Marking Code
 YM = Date Code Marking
 Y = Year ex: N = 2002
 M = Month ex: 9 = September

Date Code Key

Year	1998	1999	2000	2001	2002	2003	2004	2005	2006	2007	2008	2009
Code	J	K	L	M	N	P	R	S	T	U	V	W
Month	Jan	Feb	March	Apr	May	Jun	Jul	Aug	Sep	Oct	Nov	Dec
Code	1	2	3	4	5	6	7	8	9	O	N	D

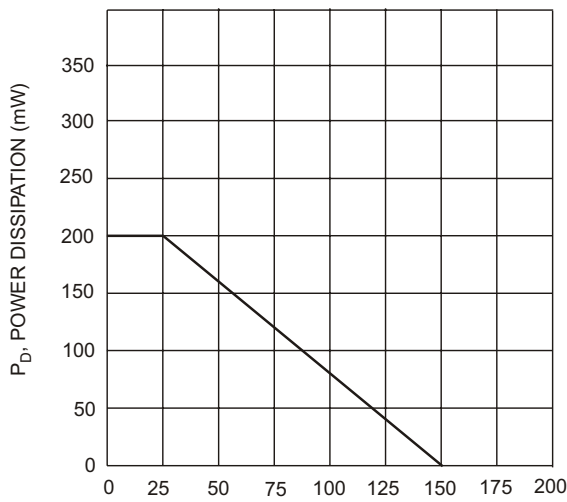

T_A , AMBIENT TEMPERATURE (°C)
 Fig. 1, Max Power Dissipation vs Ambient Temperature (Total Device)

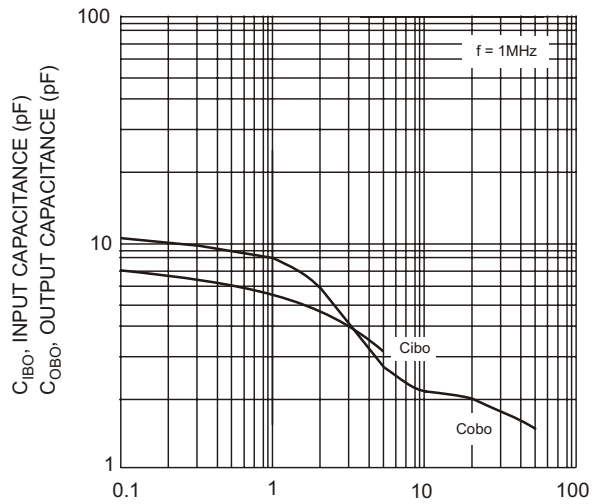

V_{CB} , COLLECTOR-BASE VOLTAGE (V)
 Fig. 2, Input and Output Capacitance vs. Collector-Base Voltage (PNP-4126)

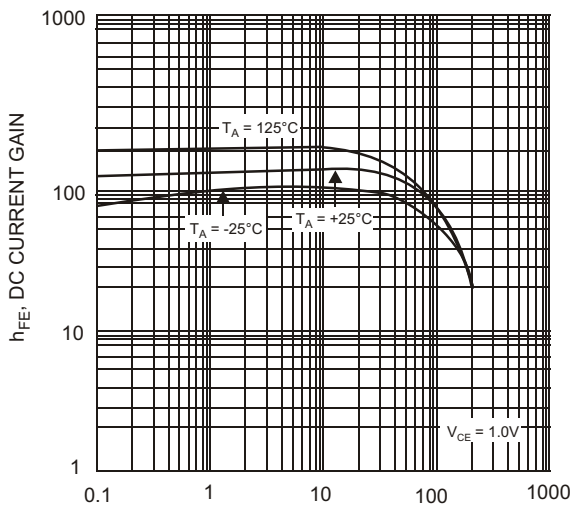

I_C , COLLECTOR CURRENT (mA)
 Fig. 3, Typical DC Current Gain vs Collector Current (PNP-4126)

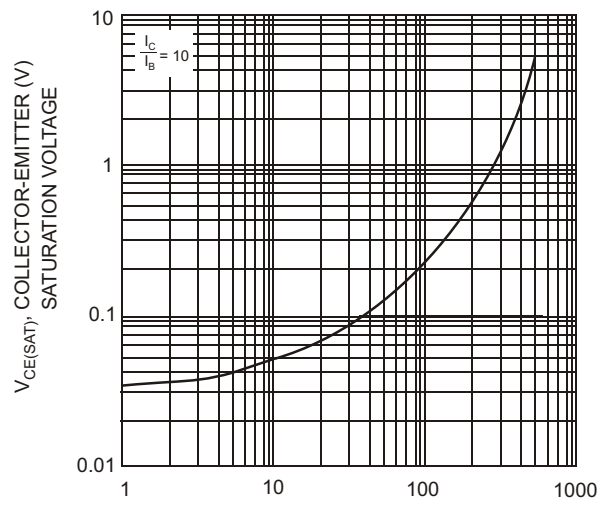

I_C , COLLECTOR CURRENT (mA)
 Fig. 4, Typical Collector-Emitter Saturation Voltage vs. Collector Current (PNP-4126)

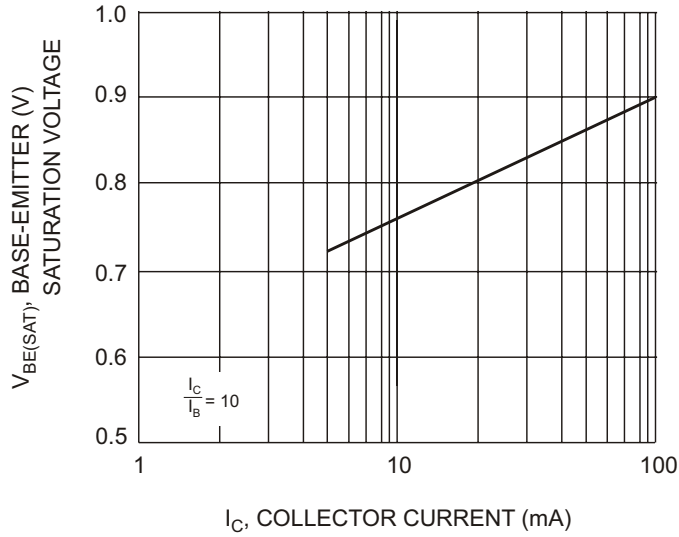

I_C , COLLECTOR CURRENT (mA)
Fig. 5, Typical Base-Emitter Saturation Voltage vs. Collector Current (PNP-4126)

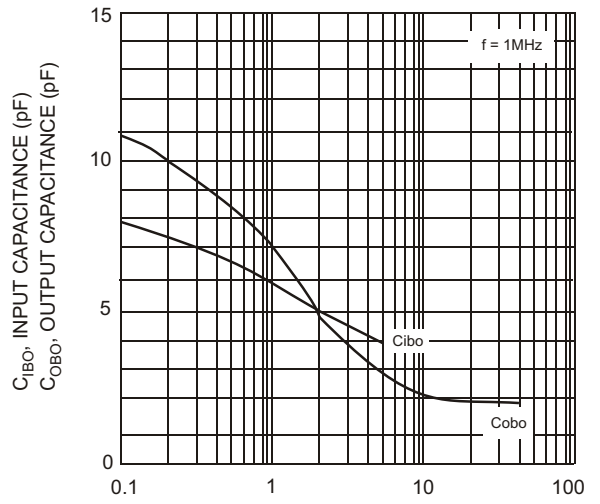

V_{CB} , COLLECTOR-BASE VOLTAGE (V)
Fig. 6, Input and Output Capacitance vs. Collector-Base Voltage (NPN-4124)

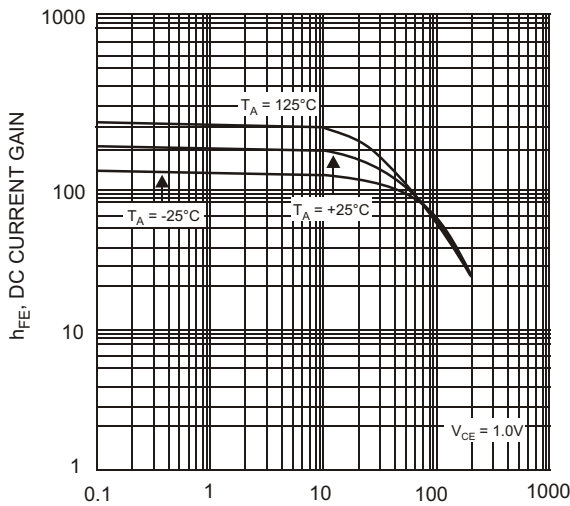

I_C , COLLECTOR CURRENT (mA)
Fig. 7, Typical DC Current Gain vs Collector Current (NPN-4124)

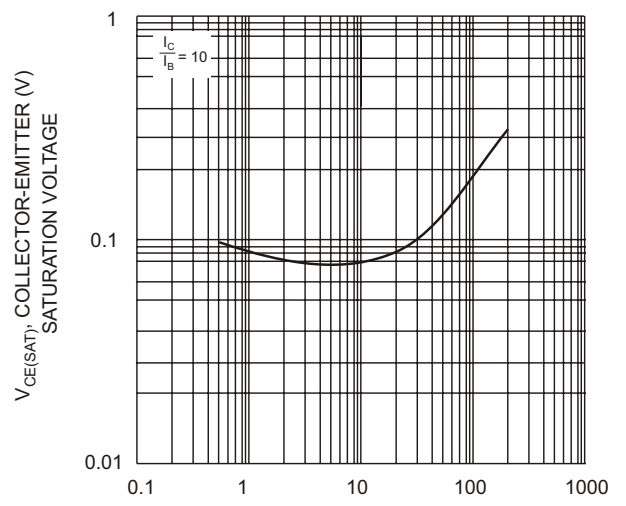

I_C , COLLECTOR CURRENT (mA)
Fig. 8, Typical Collector-Emitter Saturation Voltage vs. Collector Current (NPN-4124)

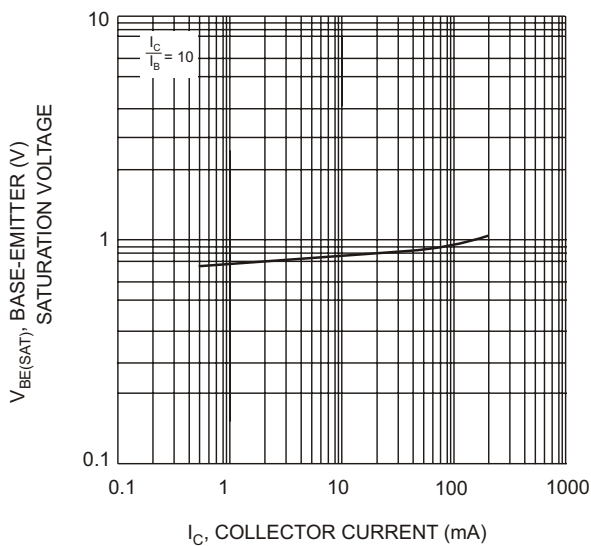

I_C , COLLECTOR CURRENT (mA)
Fig. 9, Typical Base-Emitter Saturation Voltage vs. Collector Current (NPN-4124)