

SURFACE MOUNT SCHOTTKY BARRIER RECTIFIER
VOLTAGE RANGE 20 to 60 Volts CURRENT 3.0 Amperes

FEATURES

- * Fast switching
- * Low switching noise
- * Low forward voltage drop
- * High current capability
- * High switching capability
- * High reliability
- * High surge capability

MECHANICAL DATA

- * Case: Molded plastic
- * Epoxy: Device has UL flammability classification 94V-O
- * Lead: MIL-STD-202E method 208C guaranteed
- * Metallurgically bonded construction
- * Mounting position: Any
- * Weight: 0.057 gram

MAXIMUM RATINGS AND ELECTRICAL CHARACTERISTICS

Ratings at 25 °C ambient temperature unless otherwise specified.
 Single phase, half wave, 60 Hz, resistive or inductive load.
 For capacitive load, derate current by 20%.



DO-214AC

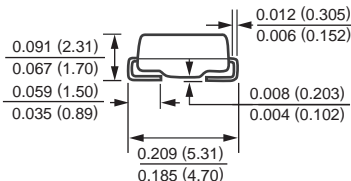
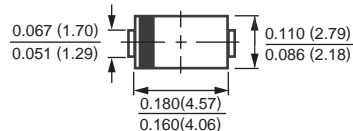

Dimensions in inches and (millimeters)

MAXIMUM RATINGS (At TA = 25°C unless otherwise noted)

RATINGS	SYMBOL	FM320A	FM330A	FM340A	FM350A	FM360A	UNITS
Maximum Recurrent Peak Reverse Voltage	VRRM	20	30	40	50	60	Volts
Maximum RMS Voltage	VRMS	14	21	28	35	42	Volts
Maximum DC Blocking Voltage	VDC	20	30	40	50	60	Volts
Maximum Average Forward Rectified Current at Derating Lead Temperature	IO	3.0					Amps
Peak Forward Surge Current 8.3 ms single half sine-wave superimposed on rated load (JEDEC method)	IFSM	80					Amps
Typical Thermal Resistance (Note 1)	RθJA	25					°C/W
Typical Junction Capacitance (Note 2)	CJ	200					pF
Operating Temperature Range	TJ	-55 to +125			-55 to +150		°C
Storage Temperature Range	TSTG	-55 to +150					°C

ELECTRICAL CHARACTERISTICS (At TA = 25°C unless otherwise noted)

CHARACTERISTICS	SYMBOL	FM320A	FM330A	FM340A	FM350A	FM360A	UNITS
Maximum Instantaneous Forward Voltage at 3.0A DC	VF	.55			.75		Volts
Maximum Average Reverse Current	IR	2.0			20		mAmps
at Rated DC Blocking Voltage							mAmps

NOTES : 1. Thermal Resistance (Junction to Ambient): Vertical PC Board Mounting, 0.5" (12.7mm) Lead Length.
 2. Measured at 1 MHz and applied reverse voltage of 4.0 volts.

RATING AND CHARACTERISTIC CURVES (FM320A THRU FM360A)

FIG. 1 - TYPICAL FORWARD CURRENT DERATING CURVE

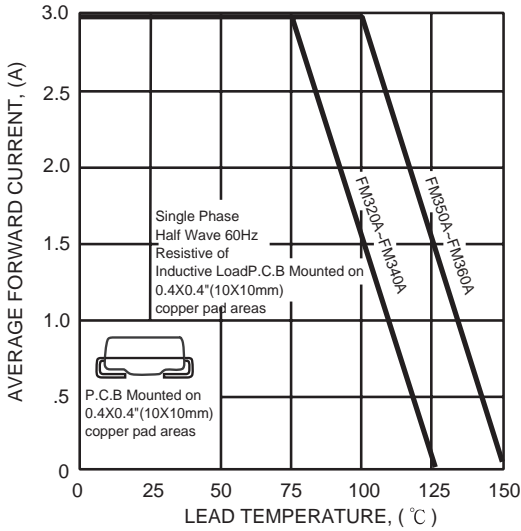

FIG. 2 - TYPICAL REVERSE CHARACTERISTICS

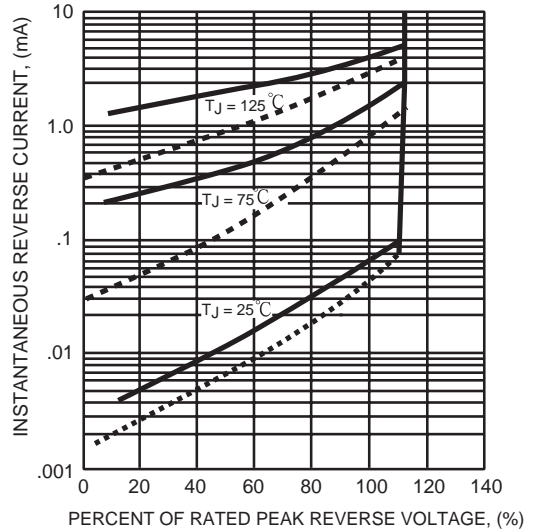

FIG. 3 - TYPICAL INSTANTANEOUS FORWARD CHARACTERISTICS

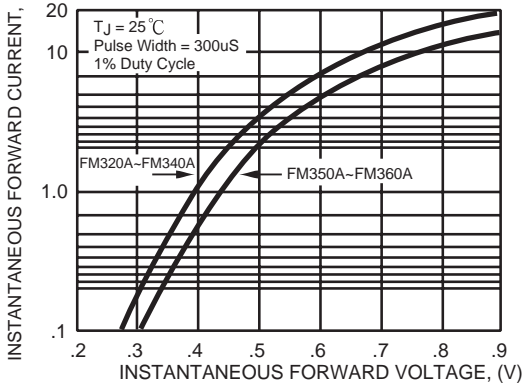

FIG. 4 - TYPICAL JUNCTION CAPACITANCE

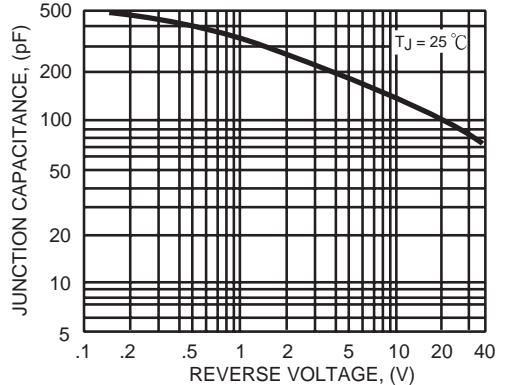
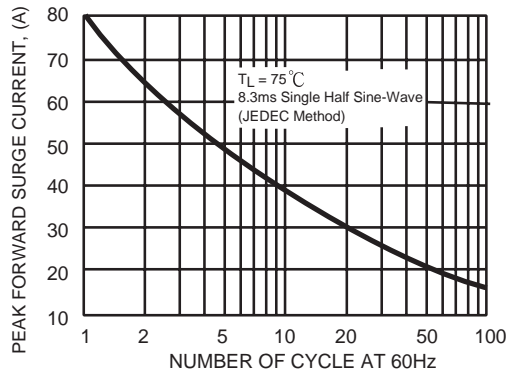
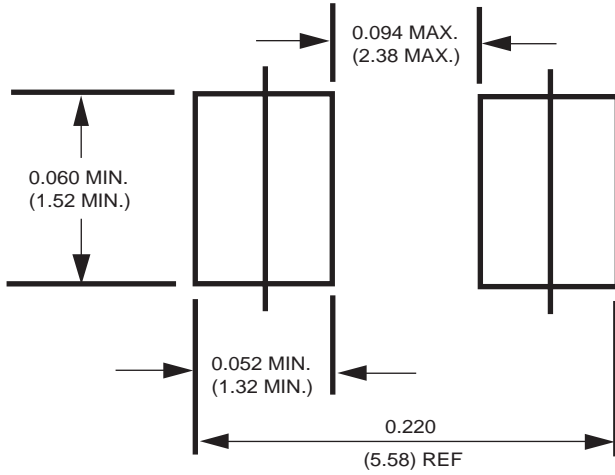

FIG. 5 - MAXIMUM NON-REPETITIVE FORWARD SURGE CURRENT



Mounting Pad Layout



Dimensions in inches and (millimeters)