



FAN3121 / FAN3122_F085 Single 9A High-Speed, Low-Side Gate Driver

Features

- Qualified to AEC Q-100
- 4.5 to 18V Operating Range
- 11.4A Peak Sink at $V_{DD} = 12V$
- 9.7A Sink / 7.1A Source at $V_{OUT} = 6V$
- Inverting Configuration (FAN3121) and Non-Inverting Configuration (FAN3122)
- Internal Resistors Turn Driver Off If No Inputs
- 23ns/19ns Typical Rise/Fall Times with 10nF Load
- 20ns Typical Propagation Delay Time
- Choice of TTL or CMOS Input Thresholds
- MillerDrive™ Technology
- 8-Lead SOIC Package
- Rated from $-40^{\circ}C$ to $+125^{\circ}C$

Applications

- Synchronous Rectifier Circuits
- High-Efficiency MOSFET Switching
- Switch-Mode Power Supplies
- DC-to-DC Converters
- Motor Control

Description

The FAN3121 and FAN3122 MOSFET drivers are designed to drive N-channel enhancement MOSFETs in low-side switching applications by providing high peak current pulses. The drivers are available with either TTL (FAN312xT) or CMOS (FAN312xC) input thresholds. Internal circuitry provides an under-voltage lockout function by holding the output low until the supply voltage is within the operating range.

FAN312x drivers incorporate the MillerDrive™ architecture for the final output stage. This bipolar / MOSFET combination provides the highest peak current during the Miller plateau stage of the MOSFET turn-on / turn-off process.

The FAN3121 and FAN3122 drivers implement an enable function on pin 3 (EN), previously unused in the industry-standard pin-out. The pin is internally pulled up to V_{DD} for active HIGH logic and can be left open for standard operation.

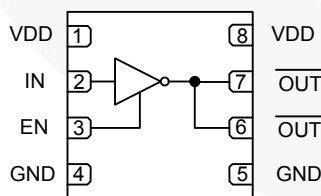

Figure 1. FAN3121 Pin Configuration

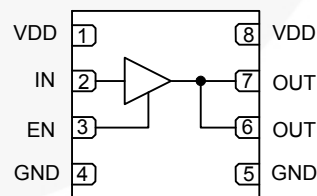

Figure 2. FAN3122 Pin Configuration

Ordering Information

Part Number	Logic	Input Threshold	Package	Eco Status	Packing Method	Quantity per Reel
FAN3121CMX_F085	Inverting Channels + Enable	CMOS	SOIC-8	RoHS	Tape & Reel	2,500
FAN3121TMX_F085		TTL	SOIC-8	RoHS	Tape & Reel	2,500
FAN3122CMX_F085	Non-Inverting Channels + Enable	CMOS	SOIC-8	RoHS	Tape & Reel	2,500
FAN3122TMX_F085		TTL	SOIC-8	RoHS	Tape & Reel	2,500

For Fairchild's definition of "green" Eco Status, please visit: http://www.fairchildsemi.com/company/green/rohs_green.html.

Package Outline

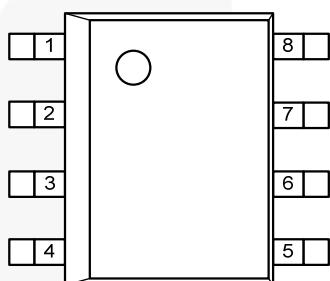

Figure 3. SOIC-8 (Top View)

Thermal Characteristics⁽¹⁾

Package	Θ_{JL} ⁽²⁾	Θ_{JT} ⁽³⁾	Θ_{JA} ⁽⁴⁾	Ψ_{JB} ⁽⁵⁾	Ψ_{JT} ⁽⁶⁾	Units
8-Pin Small Outline Integrated Circuit (SOIC)	38	29	87	41	2.3	°C/W

Notes:

- Estimates derived from thermal simulation; actual values depend on the application.
- Θ_{JL} (Θ_{JL}): Thermal resistance between the semiconductor junction and the bottom surface of all the leads (including any thermal pad) that are typically soldered to a PCB.
- Θ_{JT} (Θ_{JT}): Thermal resistance between the semiconductor junction and the top surface of the package, assuming it is held at a uniform temperature by a top-side heatsink.
- Θ_{JA} (Θ_{JA}): Thermal resistance between junction and ambient, dependent on the PCB design, heat sinking, and airflow. The value given is for natural convection with no heatsink, as specified in JEDEC standards JESD51-2, JESD51-5, and JESD51-7, as appropriate.
- Ψ_{JB} (Ψ_{JB}): Thermal characterization parameter providing correlation between semiconductor junction temperature and an application circuit board reference point for the thermal environment defined in Note 4. For the SOIC-8 package, the board reference is defined as the PCB copper adjacent to pin 6.
- Ψ_{JT} (Ψ_{JT}): Thermal characterization parameter providing correlation between the semiconductor junction temperature and the center of the top of the package for the thermal environment defined in Note 4.

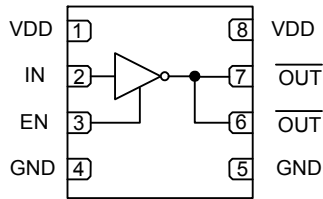

Figure 4. FAN3121 Pin Assignments (Repeated)

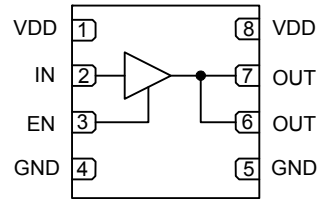

Figure 5. FAN3122 Pin Assignments (Repeated)

Pin Definitions

FAN3121	FAN3122	Name	Description
3	3	EN	Enable Input. Pull pin LOW to inhibit driver. EN has logic thresholds for both TTL and CMOS IN thresholds.
4, 5	4, 5	GND	Ground. Common ground reference for input and output circuits.
2	2	IN	Input.
	6, 7	OUT	Gate Drive Output. Held LOW unless required input is present and V_{DD} is above the UVLO threshold.
6, 7		$\overline{\text{OUT}}$	Gate Drive Output (inverted from the input). Held LOW unless required input is present and V_{DD} is above the UVLO threshold.
1, 8	1, 8	V_{DD}	Supply Voltage. Provides power to the IC.

Output Logic

FAN3121		
EN	IN	$\overline{\text{OUT}}$
0	0	0
0	1 ⁽⁷⁾	0
1 ⁽⁷⁾	0	1
1 ⁽⁷⁾	1 ⁽⁷⁾	0

FAN3122		
EN	IN	OUT
0	0 ⁽⁷⁾	0
0	1	0
1 ⁽⁷⁾	0 ⁽⁷⁾	0
1 ⁽⁷⁾	1	1

Note:

7. Default input signal if no external connection is made.

Block Diagram

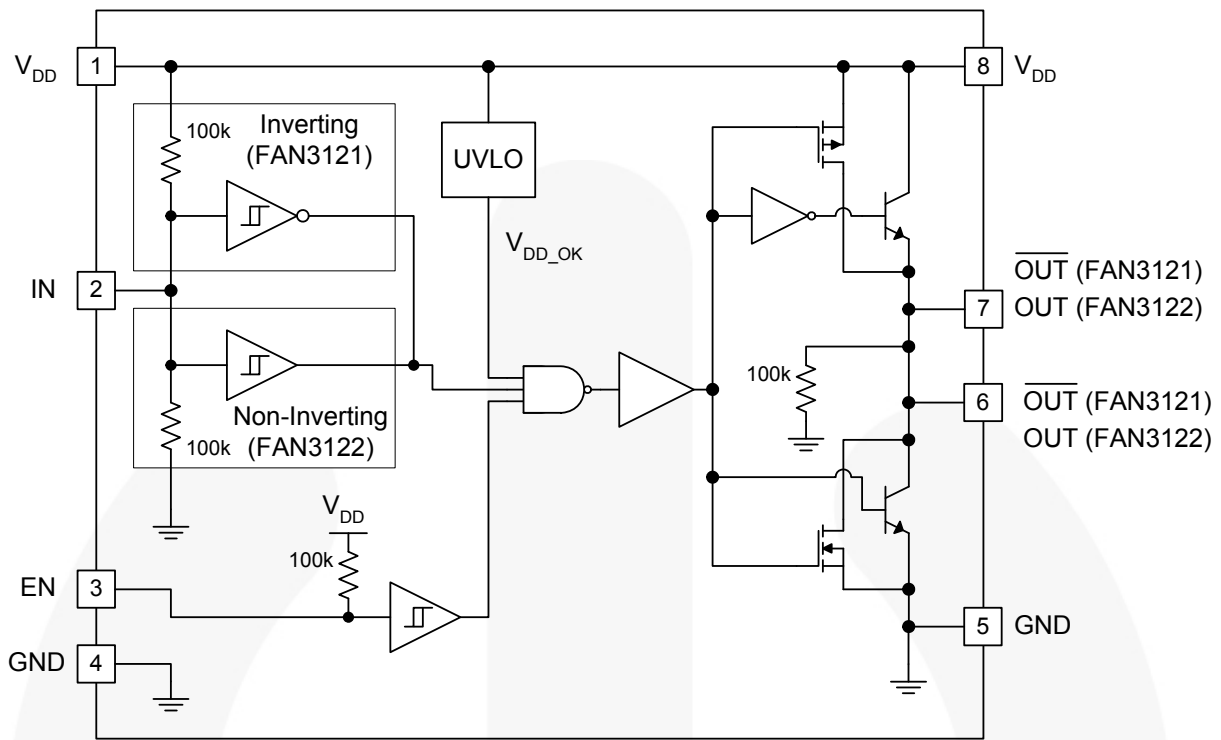

Figure 6. Block Diagram

Absolute Maximum Ratings

Stresses exceeding the absolute maximum ratings may damage the device. The device may not function or be operable above the recommended operating conditions and stressing the parts to these levels is not recommended. In addition, extended exposure to stresses above the recommended operating conditions may affect device reliability. The absolute maximum ratings are stress ratings only.

Symbol	Parameter	Min.	Max.	Unit
V_{DD}	V_{DD} to GND	-0.3	20.0	V
V_{EN}	EN to GND	GND - 0.3	$V_{DD} + 0.3$	V
V_{IN}	IN to GND	GND - 0.3	$V_{DD} + 0.3$	V
V_{OUT}	OUT to GND	GND - 0.3	$V_{DD} + 0.3$	V
T_L	Lead Soldering Temperature (10 Seconds)		+260	°C
T_J	Junction Temperature	-55	+150	°C
T_{STG}	Storage Temperature	-65	+150	°C
ESD	Human Body Model, JEDEC JESD22-A114		2	kV

Recommended Operating Conditions

The Recommended Operating Conditions table defines the conditions for actual device operation. Recommended operating conditions are specified to ensure optimal performance to the datasheet specifications. Fairchild does not recommend exceeding them or designing to Absolute Maximum Ratings.

Symbol	Parameter	Min.	Max.	Unit
V_{DD}	Supply Voltage Range	4.5	18.0	V
V_{EN}	Enable Voltage EN	0	V_{DD}	V
V_{IN}	Input Voltage IN	0	V_{DD}	V
T_A	Operating Ambient Temperature	-40	+125	°C

Electrical Characteristics

Unless otherwise noted, $V_{DD}=12V$ and $T_J=-40^{\circ}C$ to $+125^{\circ}C$. Currents are defined as positive into the device and negative out of the device.

Symbol	Parameter	Conditions	Min.	Typ.	Max.	Unit
Supply						
V_{DD}	Operating Range		4.5		18.0	V
I_{DD}	Supply Current, Inputs / EN Not Connected	TTL		0.65	0.90	mA
		CMOS ⁽⁸⁾		0.58	0.85	
V_{ON}	Turn-On Voltage		3.5	4.0	4.3	V
V_{OFF}	Turn-Off Voltage		3.25	3.75	4.15	V
Inputs (FAN312xT)⁽⁹⁾						
V_{IL_T}	INx Logic Low Threshold		0.8	1.0		V
V_{IH_T}	INx Logic High Threshold			1.7	2.0	V
I_{INx_T}	Non-inverting Input Current	IN = 0V	-1.5		1.5	μA
I_{INx_T}	Non-inverting Input Current	IN = V_{DD}	90	120	175.0	μA
I_{INx_T}	Inverting Input Current	IN = 0V	-175.0	-120	-90	μA
I_{INx_T}	Inverting Input Current	IN = V_{DD}	-1.5		1.5	μA
V_{HYS_T}	TTL Logic Hysteresis Voltage		0.40	0.70	0.85	V
Inputs (FAN312xC)⁽⁹⁾						
V_{IL_C}	INx Logic Low Threshold		30	38		$\%V_{DD}$
V_{IH_C}	INx Logic High Threshold			55	70	$\%V_{DD}$
I_{INx_C}	Non-Inverting Input Current	IN = 0V	-1.5		1.5	μA
I_{INx_C}	Non-Inverting Input Current	IN = V_{DD}	90	120	175	μA
I_{INx_C}	Inverting Input Current	IN = 0V	-175	-120	-90	μA
I_{INx_C}	Inverting Input Current	IN = V_{DD}	-1.5		1.5	μA
V_{HYS_C}	CMOS Logic Hysteresis Voltage		12	17	24	$\%V_{DD}$
ENABLE (FAN3121, FAN3122)						
V_{ENL}	Enable Logic Low Threshold	EN from 5V to 0V	1.2	1.6	2.0	V
V_{ENH}	Enable Logic High Threshold	EN from 0V to 5V	1.8	2.2	2.6	V
V_{HYS_T}	TTL Logic Hysteresis Voltage		0.2	0.6	0.8	V
R_{PU}	Enable Pull-up Resistance		68	100	134	k Ω
t_{D1}, t_{D2}	Propagation Delay, EN Rising ⁽¹⁰⁾		8	17	27	ns
t_{D1}, t_{D2}	Propagation Delay, EN Falling ⁽¹⁰⁾		14	21	33	ns

Notes:

8. Lower supply current due to inactive TTL circuitry.
9. EN inputs have modified TTL thresholds; refer to the ENABLE section.
10. See Timing Diagrams of Figure 7 and Figure 8.

Electrical Characteristics (Continued)

Unless otherwise noted, $V_{DD}=12V$ and $T_J=-40^{\circ}C$ to $+125^{\circ}C$. Currents are defined as positive into the device and negative out of the device.

OUTPUT						
I_{SINK}	OUT Current, Mid-Voltage, Sinking ⁽¹¹⁾	OUT at $V_{DD}/2$, $C_{LOAD}=1.0\mu F$, $f=1kHz$		9.7		A
I_{SOURCE}	OUT Current, Mid-Voltage, Sourcing ⁽¹¹⁾	OUT at $V_{DD}/2$, $C_{LOAD}=1.0\mu F$, $f=1kHz$		7.1		A
I_{PK_SINK}	OUT Current, Peak, Sinking ⁽¹¹⁾	$C_{LOAD}=1.0\mu F$, $f=1kHz$		11.4		A
I_{PK_SOURCE}	OUT Current, Peak, Sourcing ⁽¹¹⁾	$C_{LOAD}=1.0\mu F$, $f=1kHz$		10.6		A
V_{OH}	High Level Output Voltage	$V_{OH} = V_{DD} - V_{OUT}$, $I_{OUT} = -1mA$		15	35	mV
V_{OL}	Low Level Output Voltage	$I_{OUT} = 1mA$		10	25	mV
t_{RISE}	Output Rise Time ⁽¹²⁾	$C_{LOAD}=10nF$	18	23	29	ns
t_{FALL}	Output Fall Time ⁽¹²⁾	$C_{LOAD}=10nF$	11	19	27	ns
t_{D1} , t_{D2}	Output Propagation Delay, CMOS Inputs ⁽¹²⁾	$0 - 12V_{IN}$, $1V/ns$ Slew Rate	9	18	28	ns
t_{D1} , t_{D2}	Output Propagation Delay, TTL Inputs ⁽¹²⁾	$0 - 5V_{IN}$, $1V/ns$ Slew Rate	9	23	35	ns

Notes:

- 11. Not tested in production.
- 12. See Timing Diagrams of Figure 7 and Figure 8.

Timing Diagrams

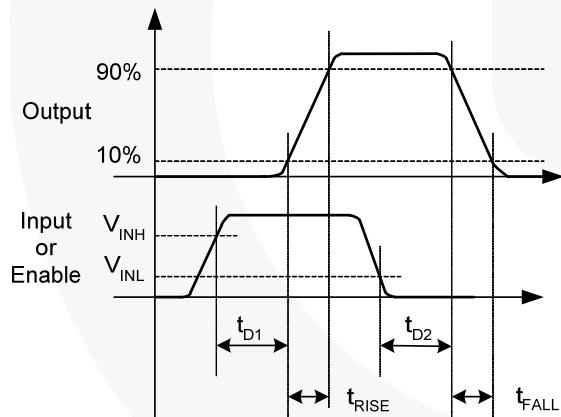

Figure 7. Non-Inverting

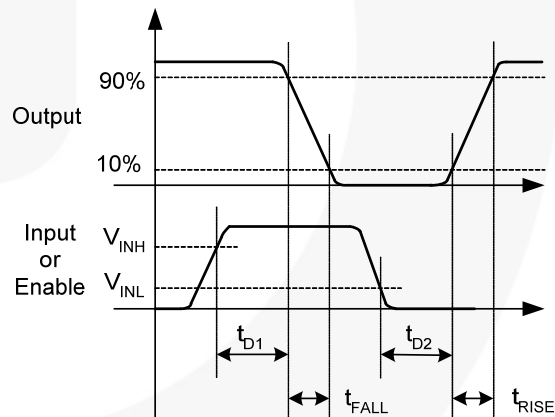

Figure 8. Inverting

Typical Performance Characteristics

Typical characteristics are provided at 25°C and $V_{DD}=12V$ unless otherwise noted.

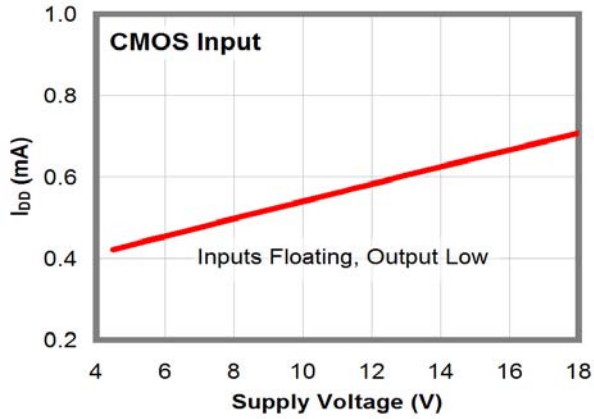

Figure 9. I_{DD} (Static) vs. Supply Voltage⁽¹³⁾

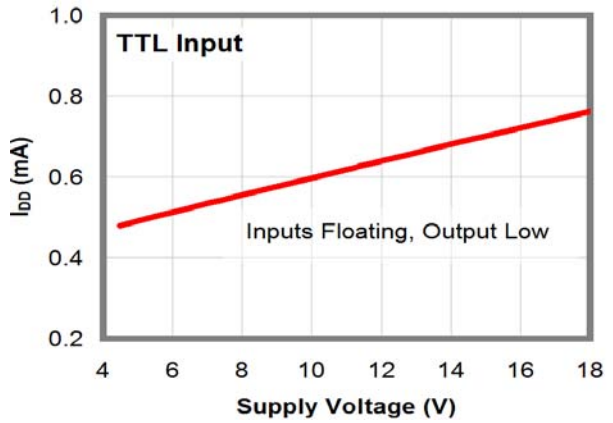

Figure 10. I_{DD} (Static) vs. Supply Voltage⁽¹³⁾

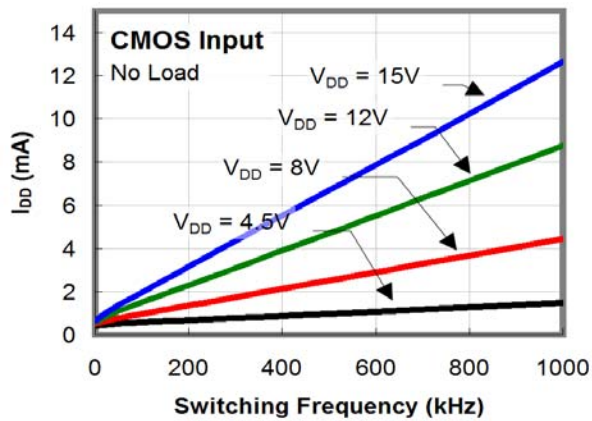

Figure 11. I_{DD} (No-Load) vs. Frequency

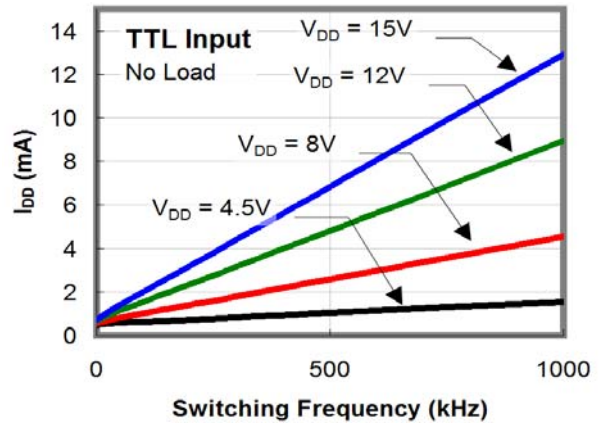

Figure 12. I_{DD} (No-Load) vs. Frequency

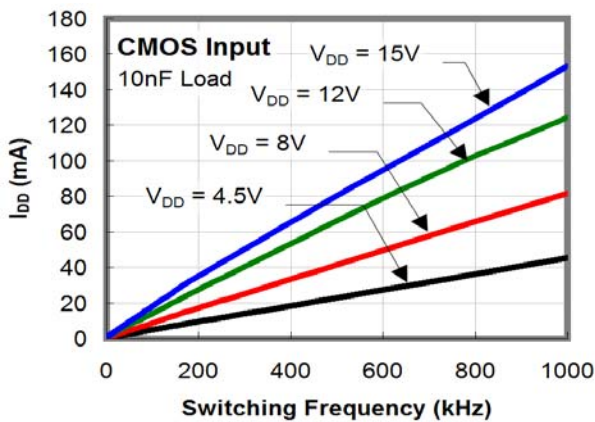

Figure 13. I_{DD} (10nF Load) vs. Frequency

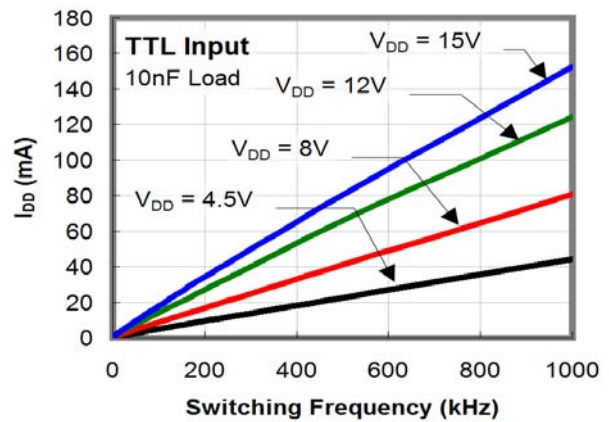

Figure 14. I_{DD} (10nF Load) vs. Frequency

Typical Performance Characteristics

Typical characteristics are provided at 25°C and $V_{DD}=12V$ unless otherwise noted.

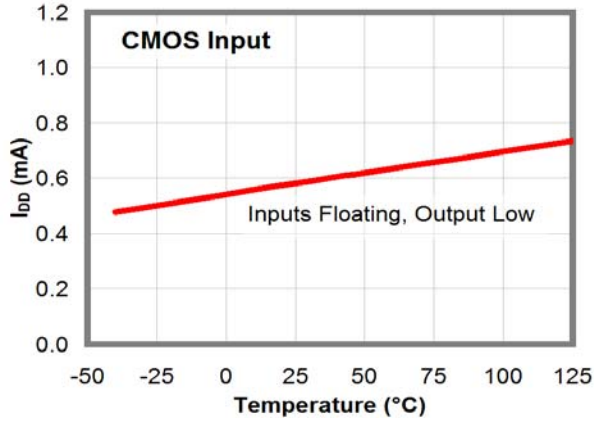

Figure 15. I_{DD} (Static) vs. Temperature⁽¹³⁾

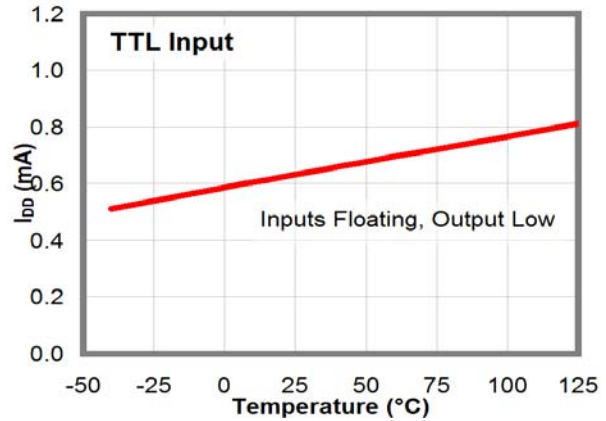

Figure 16. I_{DD} (Static) vs. Temperature⁽¹³⁾

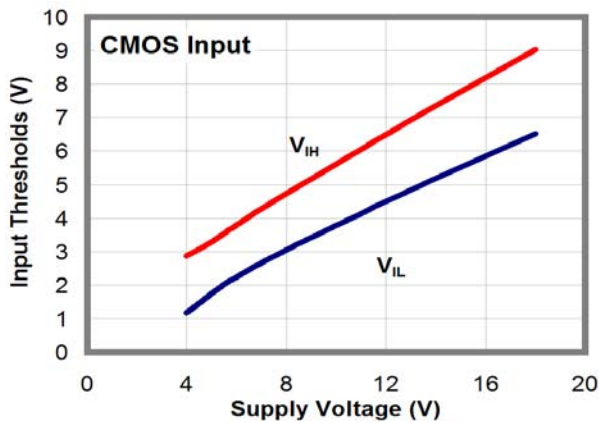

Figure 17. Input Thresholds vs. Supply Voltage

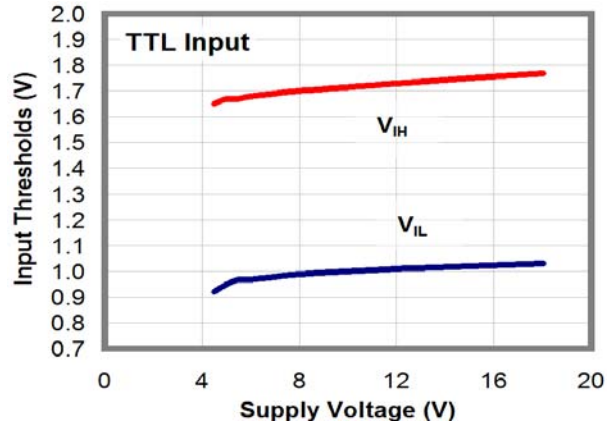

Figure 18. Input Thresholds vs. Supply Voltage

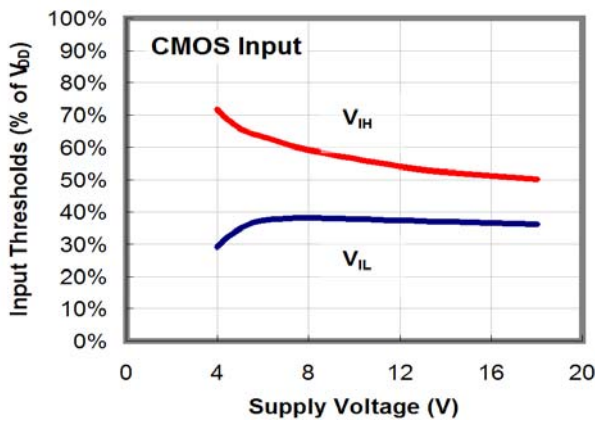

Figure 19. Input Thresholds % vs. Supply Voltage

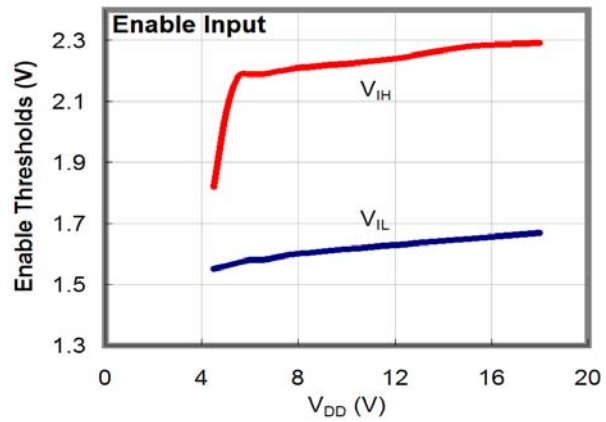

Figure 20. Enable Thresholds vs. Supply Voltage

Typical Performance Characteristics

Typical characteristics are provided at 25°C and $V_{DD}=12V$ unless otherwise noted.

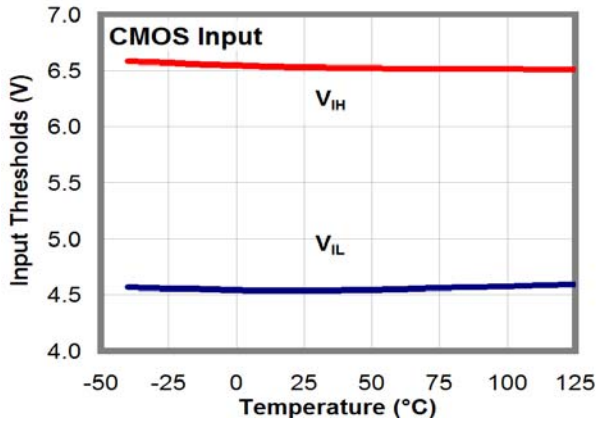

Figure 21. CMOS Input Thresholds vs. Temperature

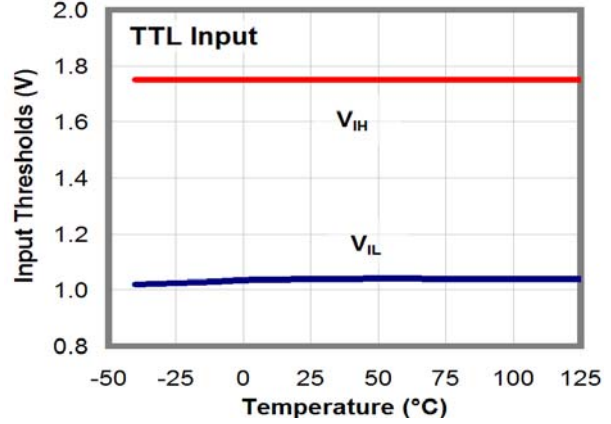

Figure 22. TTL Input Thresholds vs. Temperature

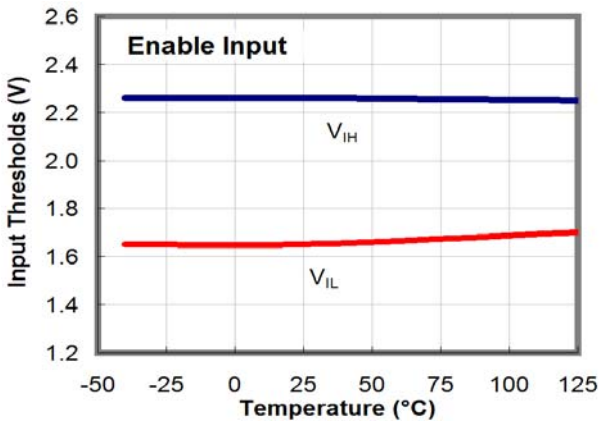

Figure 23. Enable Thresholds vs. Temperature

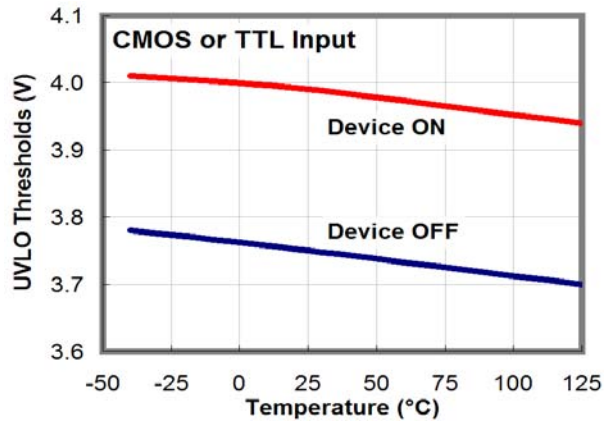

Figure 24. UVLO Thresholds vs. Temperature

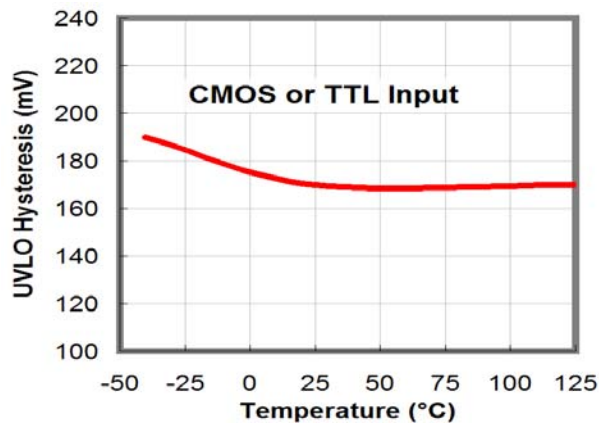

Figure 25. UVLO Hysteresis vs. Temperature

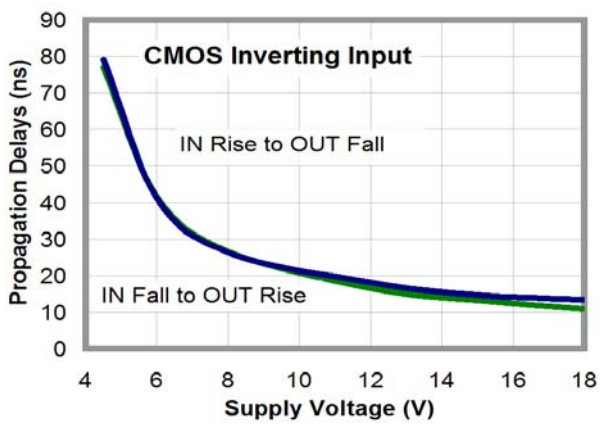

Figure 26. Propagation Delay vs. Supply Voltage

Typical Performance Characteristics

Typical characteristics are provided at 25°C and $V_{DD}=12V$ unless otherwise noted.

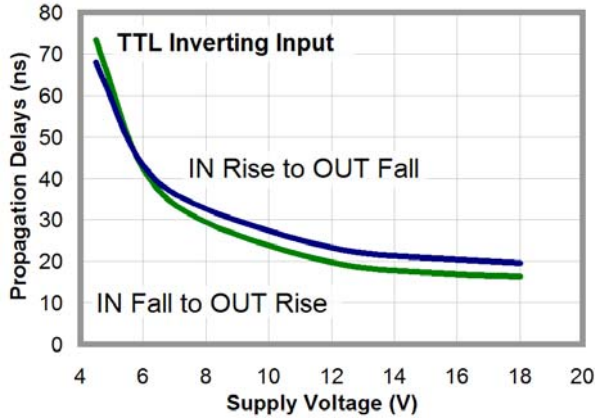

Figure 27. Propagation Delay vs. Supply Voltage

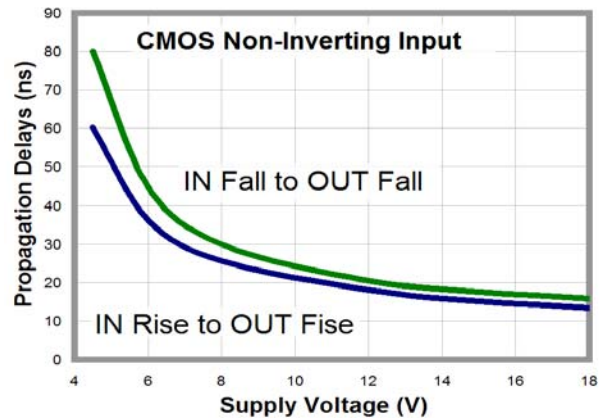

Figure 28. Propagation Delay vs. Supply Voltage

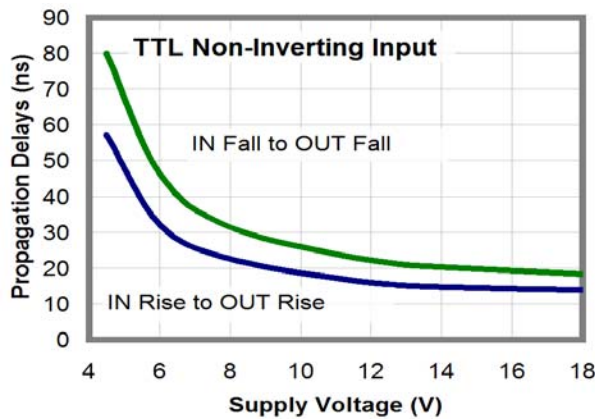

Figure 29. Propagation Delay vs. Supply Voltage

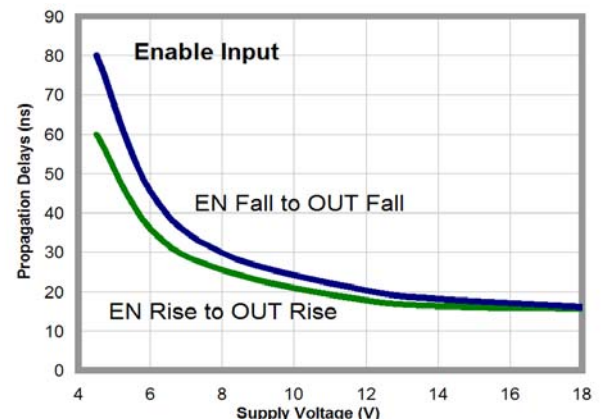

Figure 30. Propagation Delay vs. Supply Voltage

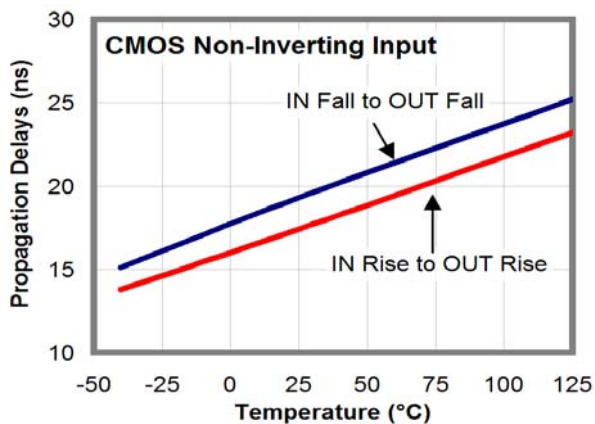

Figure 31. Propagation Delays vs. Temperature

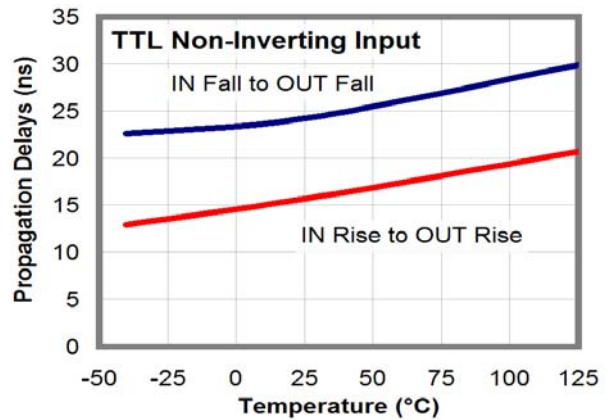

Figure 32. Propagation Delays vs. Temperature

Typical Performance Characteristics

Typical characteristics are provided at 25°C and $V_{DD}=12V$ unless otherwise noted.

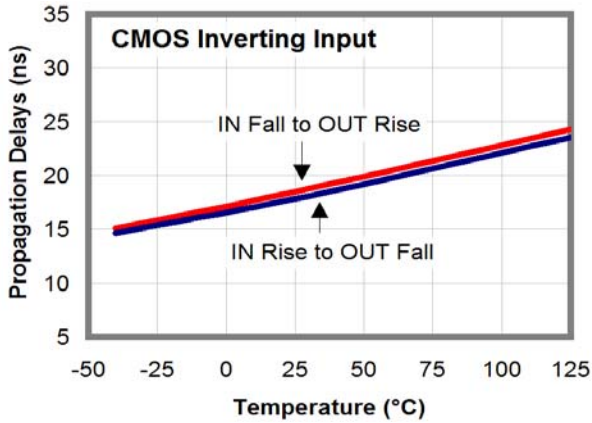

Figure 33. Propagation Delays vs. Temperature

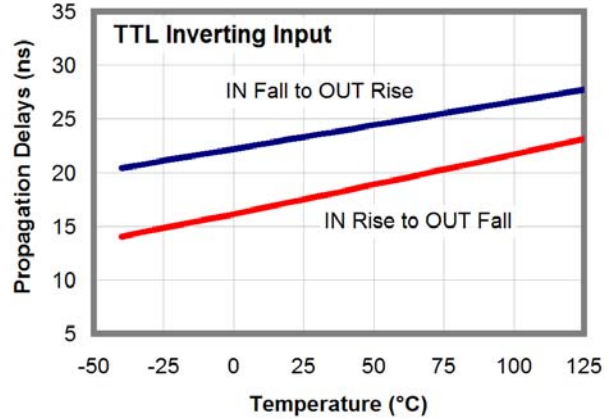

Figure 34. Propagation Delays vs. Temperature

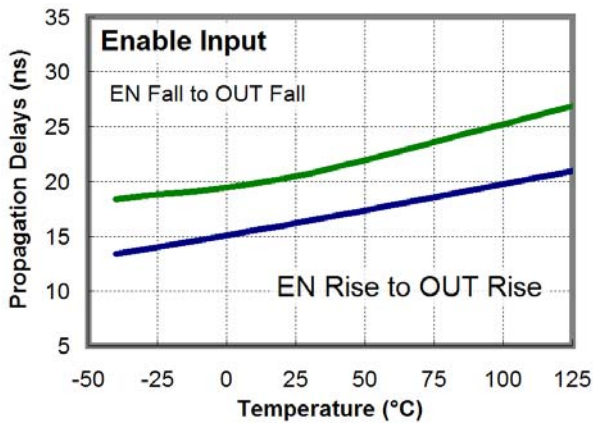

Figure 35. Propagation Delays vs. Temperature

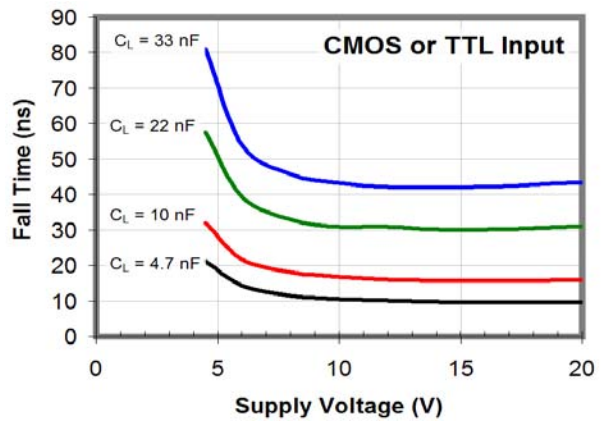

Figure 36. Fall Time vs. Supply Voltage

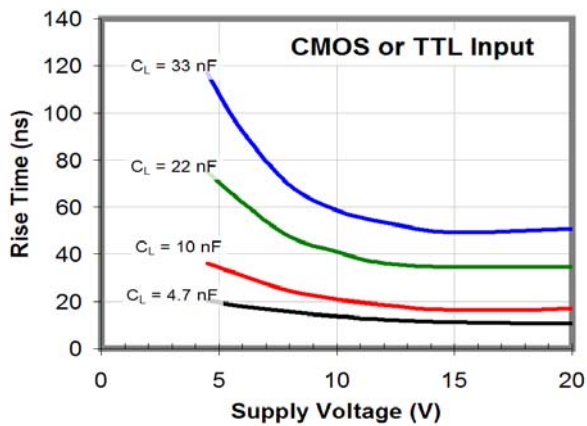

Figure 37. Rise Time vs. Supply Voltage

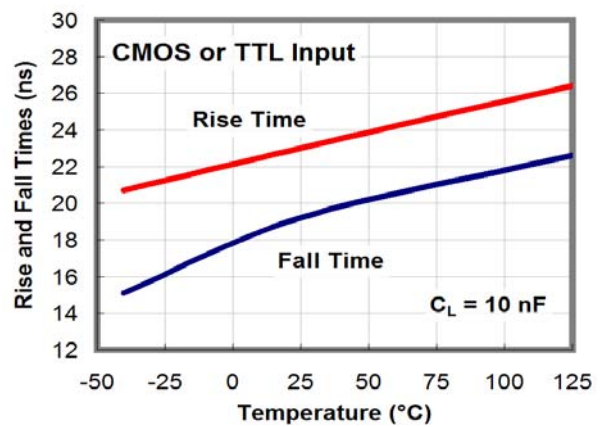

Figure 38. Rise and Fall Time vs. Temperature

Typical Performance Characteristics

Typical characteristics are provided at 25°C and $V_{DD}=12V$ unless otherwise noted.

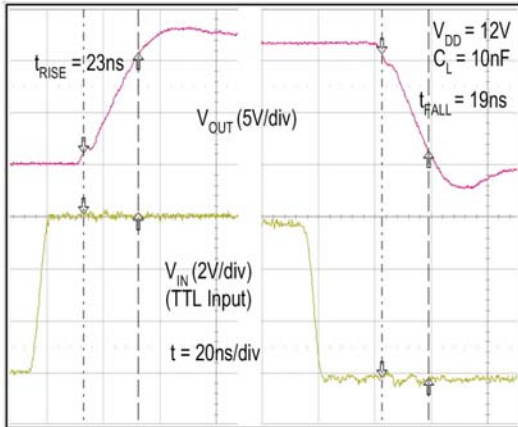

Figure 39. Rise / Fall Waveforms with 10nF Load

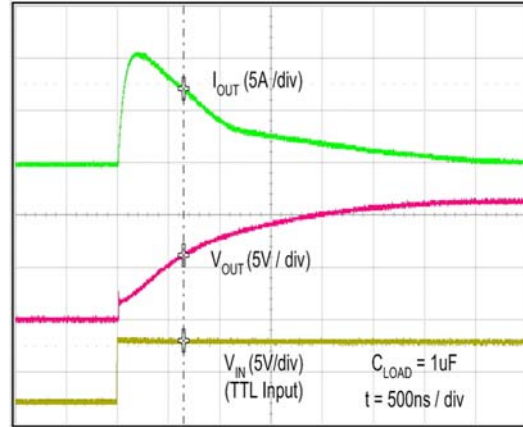

Figure 40. Quasi-Static Source Current with $V_{DD}=12V$ ⁽¹⁴⁾

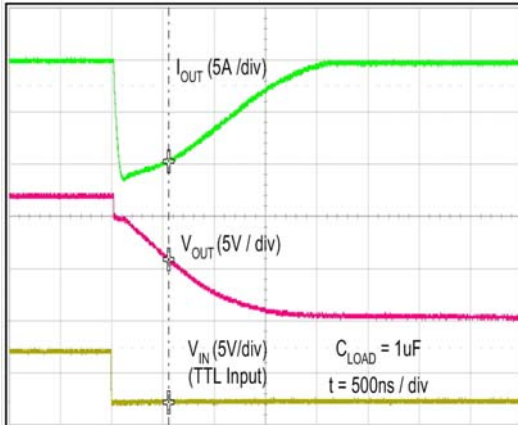

Figure 41. Quasi-Static Sink Current with $V_{DD}=12V$ ⁽¹⁴⁾

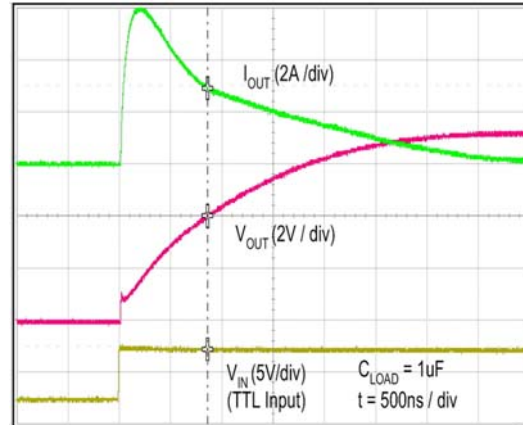

Figure 42. Quasi-Static Source Current with $V_{DD}=8V$ ⁽¹⁴⁾

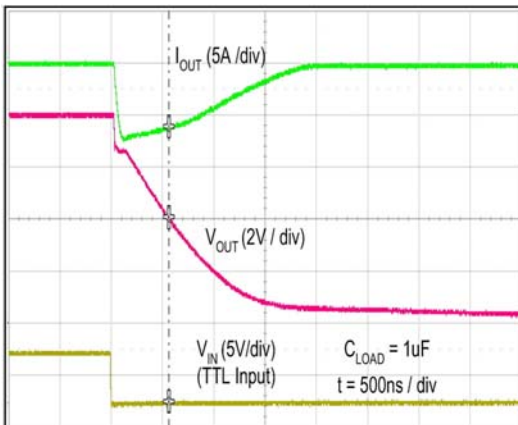

Figure 43. Quasi-Static Sink Current with $V_{DD}=8V$ ⁽¹⁴⁾

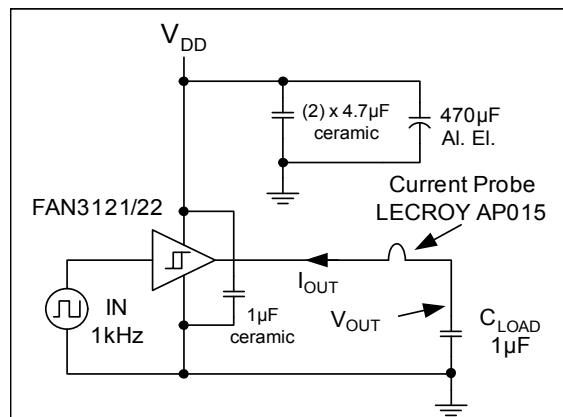

Figure 44. Quasi-Static I_{OUT} / V_{OUT} Test Circuit

Notes:

13. For any inverting inputs pulled LOW, non-inverting inputs pulled HIGH, or outputs driven HIGH; static I_{DD} increases by the current flowing through the corresponding pull-up/down resistor, shown in Figure 6.
14. The initial spike in each current waveform is a measurement artifact caused by the stray inductance of the current-measurement loop.

Applications Information

The FAN3121 and FAN3122 family offers versions in either TTL or CMOS input configuration. In the FAN3121T and FAN3122T, the input thresholds meet industry-standard TTL-logic thresholds independent of the V_{DD} voltage, and there is a hysteresis voltage of approximately 0.7V. These levels permit the inputs to be driven from a range of input logic signal levels for which a voltage over 2V is considered logic HIGH. The driving signal for the TTL inputs should have fast rising and falling edges with a slew rate of 6V/ μ s or faster, so the rise time from 0 to 3.3V should be 550ns or less.

The FAN3121 and FAN3122 output can be enabled or disabled using the EN pin with a very rapid response time. If EN is not externally connected, an internal pull-up resistor enables the driver by default. The EN pin has logic thresholds for parts with either TTL or CMOS IN thresholds.

In the FAN3121C and FAN3122C, the logic input thresholds are dependent on the V_{DD} level and, with V_{DD} of 12V, the logic rising edge threshold is approximately 55% of V_{DD} and the input falling edge threshold is approximately 38% of V_{DD} . The CMOS input configuration offers a hysteresis voltage of approximately 17% of V_{DD} . The CMOS inputs can be used with relatively slow edges (approaching DC) if good decoupling and bypass techniques are incorporated in the system design to prevent noise from violating the input voltage hysteresis window. This allows setting precise timing intervals by fitting an R-C circuit between the controlling signal and the IN pin of the driver. The slow rising edge at the IN pin of the driver introduces a delay between the controlling signal and the OUT pin of the driver.

Static Supply Current

In the I_{DD} (static) Typical Performance Characteristics, the curves are produced with all inputs / enables floating (OUT is LOW) and indicates the lowest static I_{DD} current for the tested configuration. For other states, additional current flows through the 100k Ω resistors on the inputs and outputs, as shown in the block diagram (see Figure 6). In these cases, the actual static I_{DD} current is the value obtained from the curves, plus this additional current.

MillerDrive™ Gate-Drive Technology

FAN312x gate drivers incorporate the MillerDrive™ architecture shown in Figure 45. For the output stage, a combination of bipolar and MOS devices provide large currents over a wide range of supply voltage and temperature variations. The bipolar devices carry the bulk of the current as OUT swings between 1/3 to 2/3 V_{DD} and the MOS devices pull the output to the HIGH or LOW rail.

The purpose of the Miller Drive™ architecture is to speed up switching by providing high current during the Miller plateau region when the gate-drain capacitance of

the MOSFET is being charged or discharged as part of the turn-on / turn-off process.

For applications with zero voltage switching during the MOSFET turn-on or turn-off interval, the driver supplies high peak current for fast switching, even though the Miller plateau is not present. This situation often occurs in synchronous rectifier applications because the body diode is generally conducting before the MOSFET is switched on.

The output pin slew rate is determined by V_{DD} voltage and the load on the output. It is not user adjustable, but a series resistor can be added if a slower rise or fall time at the MOSFET gate is needed.

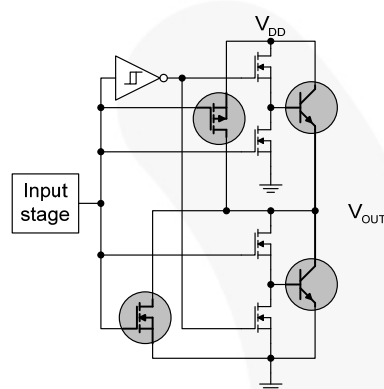

Figure 45. Miller Drive™ Output Architecture

Under-Voltage Lockout (UVLO)

The FAN312x startup logic is optimized to drive ground-referenced N-channel MOSFETs with an under-voltage lockout (UVLO) function to ensure that the IC starts in an orderly fashion. When V_{DD} is rising, yet below the 4.0V operational level, this circuit holds the output low, regardless of the status of the input pins. After the part is active, the supply voltage must drop 0.25V before the part shuts down. This hysteresis helps prevent chatter when low V_{DD} supply voltages have noise from the power switching. This configuration is not suitable for driving high-side P-channel MOSFETs because the low output voltage of the driver would turn the P-channel MOSFET on with V_{DD} below 4.0V.

V_{DD} Bypassing and Layout Considerations

The FAN3121 and FAN3122 are available in either 8-lead SOIC or MLP packages. In either package, the V_{DD} pins 1 and 8 and the GND pins 4 and 5 should be connected together on the PCB.

In typical FAN312x gate-driver applications, high-current pulses are needed to charge and discharge the gate of a power MOSFET in time intervals of 50ns or less. A bypass capacitor with low ESR and ESL should be connected directly between the V_{DD} and GND pins to provide these large current pulses without causing unacceptable ripple on the V_{DD} supply. To meet these requirements in a small size, a ceramic capacitor of 1 μ F

or larger is typically used, with a dielectric material such as X7R, to limit the change in capacitance over the temperature and / or voltage application ranges.

Figure 46 shows the pulsed gate drive current path when the gate driver is supplying gate charge to turn the MOSFET on. The current is supplied from the local bypass capacitor C_{BYP} and flows through the driver to the MOSFET gate and to ground. To reach the high peak currents possible with the FAN312x family, the resistance and inductance in the path should be minimized. The localized C_{BYP} acts to contain the high peak current pulses within this driver-MOSFET circuit, preventing them from disturbing the sensitive analog circuitry in the PWM controller.

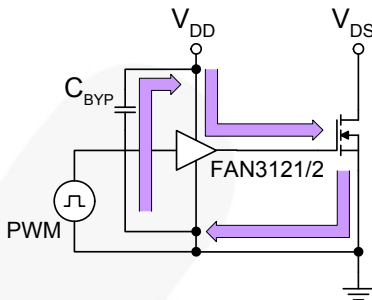

Figure 46. Current Path for MOSFET Turn-On

Figure 47 shows the path the current takes when the gate driver turns the MOSFET off. Ideally, the driver shunts the current directly to the source of the MOSFET in a small circuit loop. For fast turn-off times, the resistance and inductance in this path should be minimized.

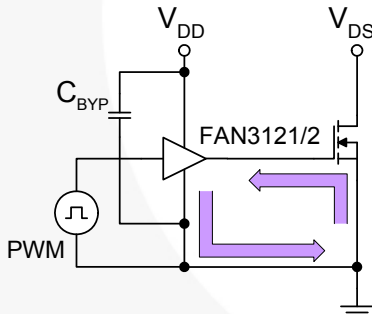

Figure 47. Current Path for MOSFET Turn-Off

Operational Waveforms

At power up, the FAN3121 inverting driver shown in Figure 48 holds the output LOW until the V_{DD} voltage reaches the UVLO turn-on threshold, as indicated in Figure 49. This facilitates proper startup control of low-side N-channel MOSFETs.

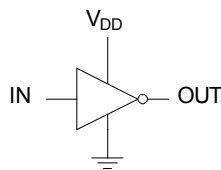

Figure 48. Inverting Configuration

The OUT pulses' magnitude follows V_{DD} magnitude with the output polarity inverted from the input until steady-state V_{DD} is reached.

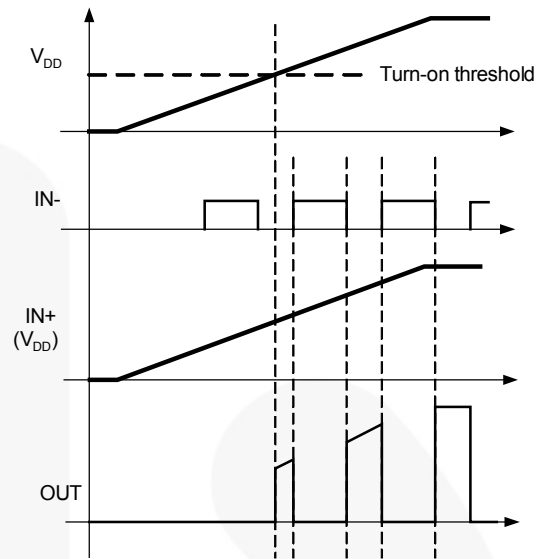

Figure 49. Inverting Startup Waveforms

At power up, the FAN3122 non-inverting driver, shown in Figure 50, holds the output LOW until the V_{DD} voltage reaches the UVLO turn-on threshold, as indicated in Figure 51. The OUT pulses magnitude follow V_{DD} magnitude until steady-state V_{DD} is reached.

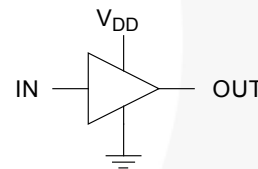

Figure 50. Non-Inverting Driver

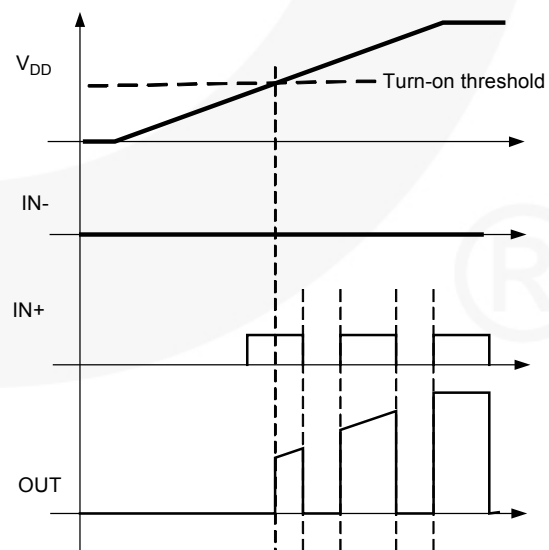

Figure 51. Non-Inverting Startup Waveforms

Thermal Guidelines

Gate drivers used to switch MOSFETs and IGBTs at high frequencies can dissipate significant amounts of power. It is important to determine the driver power dissipation and the resulting junction temperature in the application to ensure that the part is operating within acceptable temperature limits.

The total power dissipation in a gate driver is the sum of two components, P_{GATE} and P_{DYNAMIC} :

$$P_{\text{TOTAL}} = P_{\text{GATE}} + P_{\text{DYNAMIC}} \quad (1)$$

Gate Driving Loss: The most significant power loss results from supplying gate current (charge per unit time) to switch the load MOSFET on and off at the switching frequency. The power dissipation that results from driving a MOSFET at a specified gate-source voltage, V_{GS} , with gate charge, Q_{G} , at switching frequency, f_{SW} , is determined by:

$$P_{\text{GATE}} = Q_{\text{G}} \cdot V_{\text{GS}} \cdot f_{\text{SW}} \quad (2)$$

Dynamic Pre-drive / Shoot-through Current: A power loss resulting from internal current consumption under dynamic operating conditions, including pin pull-up / pull-down resistors, can be obtained using the "IDD (No-Load) vs. Frequency" graphs in Typical Performance Characteristics to determine the current I_{DYNAMIC} drawn from V_{DD} under actual operating conditions:

$$P_{\text{DYNAMIC}} = I_{\text{DYNAMIC}} \cdot V_{\text{DD}} \quad (3)$$

Once the power dissipated in the driver is determined, the driver junction rise with respect to circuit board can be evaluated using the following thermal equation, assuming Ψ_{JB} was determined for a similar thermal design (heat sinking and air flow):

$$T_{\text{J}} = P_{\text{TOTAL}} \cdot \Psi_{\text{JB}} + T_{\text{B}} \quad (4)$$

where:

T_{J} = driver junction temperature;

Ψ_{JB} = (psi) thermal characterization parameter relating temperature rise to total power dissipation; and

T_{B} = board temperature in location as defined in the Thermal Characteristics table.

In a full-bridge synchronous rectifier application, shown in Figure 522, each FAN3122 drives a parallel combination of two high-current MOSFETs, (such as FDMS8660S). The typical gate charge for each SR MOSFET is 70nC with $V_{\text{GS}} = V_{\text{DD}} = 9\text{V}$. At a switching frequency of 300kHz, the total power dissipation is:

$$P_{\text{GATE}} = 2 \cdot 70\text{nC} \cdot 9\text{V} \cdot 300\text{kHz} = 0.378\text{W} \quad (5)$$

$$P_{\text{DYNAMIC}} = 2\text{mA} \cdot 9\text{V} = 18\text{mW} \quad (6)$$

$$P_{\text{TOTAL}} = 0.396\text{W} \quad (7)$$

The SOIC-8 has a junction-to-board thermal characterization parameter of $\Psi_{\text{JB}} = 42^\circ\text{C/W}$. In a system application, the localized temperature around the device is a function of the layout and construction of the PCB along with airflow across the surfaces. To ensure reliable operation, the maximum junction temperature of the device must be prevented from exceeding the maximum rating of 150°C ; with 80% derating, T_{J} would be limited to 120°C . Rearranging Equation 4 determines the board temperature required to maintain the junction temperature below 120°C :

$$T_{\text{B,MAX}} = T_{\text{J}} - P_{\text{TOTAL}} \cdot \Psi_{\text{JB}} \quad (8)$$

$$T_{\text{B,MAX}} = 120^\circ\text{C} - 0.396\text{W} \cdot 42^\circ\text{C/W} = 104^\circ\text{C} \quad (9)$$

Typical Application Diagrams

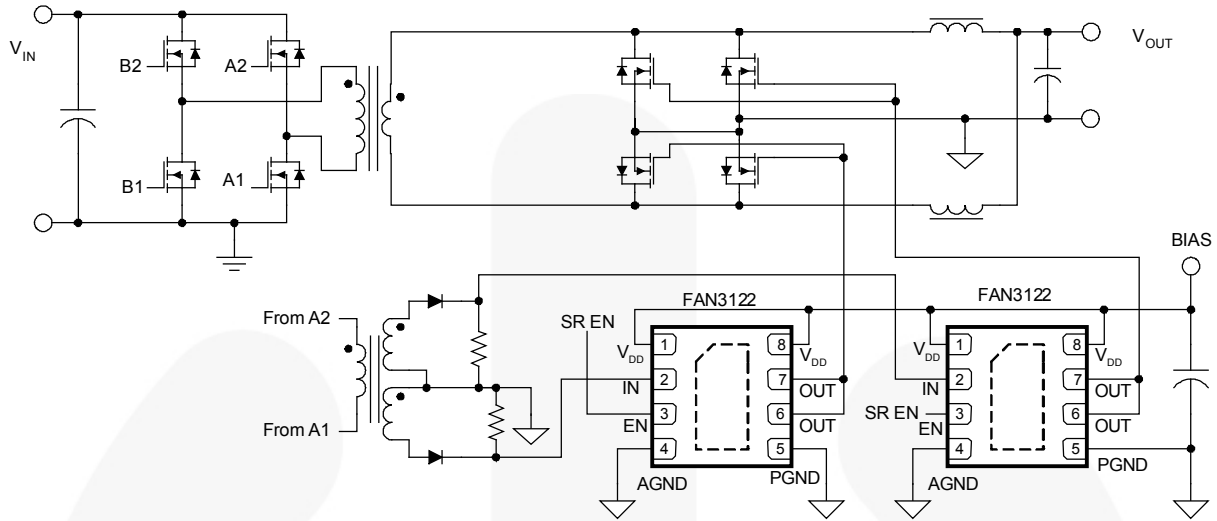

Figure 52. Full-Bridge Synchronous Rectification

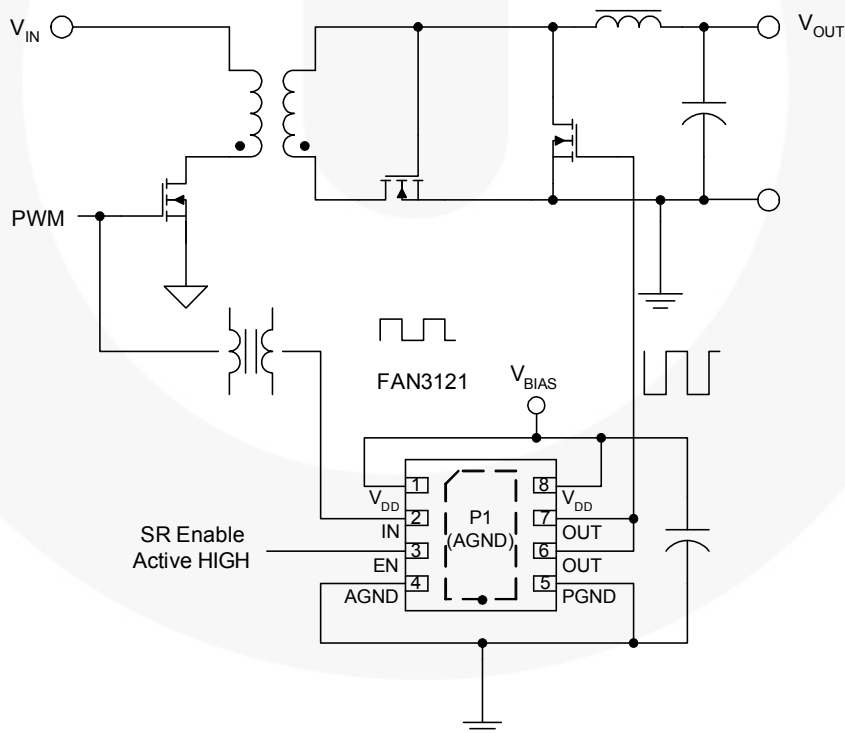

Figure 53. Hybrid Synchronous Rectification in a Forward Converter

Table 1. Related Products

Part Number	Type	Gate Drive ⁽¹⁵⁾ (Sink/Src)	Input Threshold	Logic	Package
FAN3100C	Single 2A	+2.5A / -1.8A	CMOS	Single Channel of Two-Input/One-Output	SOT23-5
FAN3100T	Single 2A	+2.5A / -1.8A	TTL	Single Channel of Two-Input/One-Output	SOT23-5
FAN3226C	Dual 2A	+2.4A / -1.6A	CMOS	Dual Inverting Channels + Dual Enable	SOIC8
FAN3226T	Dual 2A	+2.4A / -1.6A	TTL	Dual Inverting Channels + Dual Enable	SOIC8
FAN3227C	Dual 2A	+2.4A / -1.6A	CMOS	Dual Non-Inverting Channels + Dual Enable	SOIC8
FAN3227T	Dual 2A	+2.4A / -1.6A	TTL	Dual Non-Inverting Channels + Dual Enable	SOIC8
FAN3228C	Dual 2A	+2.4A / -1.6A	CMOS	Dual Channels of Two-Input/One-Output, Pin Config.1	SOIC8
FAN3228T	Dual 2A	+2.4A / -1.6A	TTL	Dual Channels of Two-Input/One-Output, Pin Config.1	SOIC8
FAN3229C	Dual 2A	+2.4A / -1.6A	CMOS	Dual Channels of Two-Input/One-Output, Pin Config.2	SOIC8
FAN3229T	Dual 2A	+2.4A / -1.6A	TTL	Dual Channels of Two-Input/One-Output, Pin Config.2	SOIC8
FAN3223C	Dual 4A	+4.3A / -2.8A	CMOS	Dual Inverting Channels + Dual Enable	SOIC8
FAN3223T	Dual 4A	+4.3A / -2.8A	TTL	Dual Inverting Channels + Dual Enable	SOIC8
FAN3224C	Dual 4A	+4.3A / -2.8A	CMOS	Dual Non-Inverting Channels + Dual Enable	SOIC8
FAN3224T	Dual 4A	+4.3A / -2.8A	TTL	Dual Non-Inverting Channels + Dual Enable	SOIC8
FAN3225C	Dual 4A	+4.3A / -2.8A	CMOS	Dual Channels of Two-Input/One-Output	SOIC8
FAN3225T	Dual 4A	+4.3A / -2.8A	TTL	Dual Channels of Two-Input/One-Output	SOIC8
FAN3121C	Single 9A	+9.7A / -7.1A	CMOS	Single Inverting Channels + Enable	SOIC8
FAN3121T	Single 9A	+9.7A / -7.1A	TTL	Single Inverting Channels + Enable	SOIC8
FAN3122C	Single 9A	+9.7A / -7.1A	CMOS	Single Non-Inverting Channels + Enable	SOIC8
FAN3122T	Single 9A	+9.7A / -7.1A	TTL	Single Non-Inverting Channels + Enable	SOIC8

Note:15. Typical currents with OUT at 6V and $V_{DD} = 12V$.

Physical Dimensions (Continued)

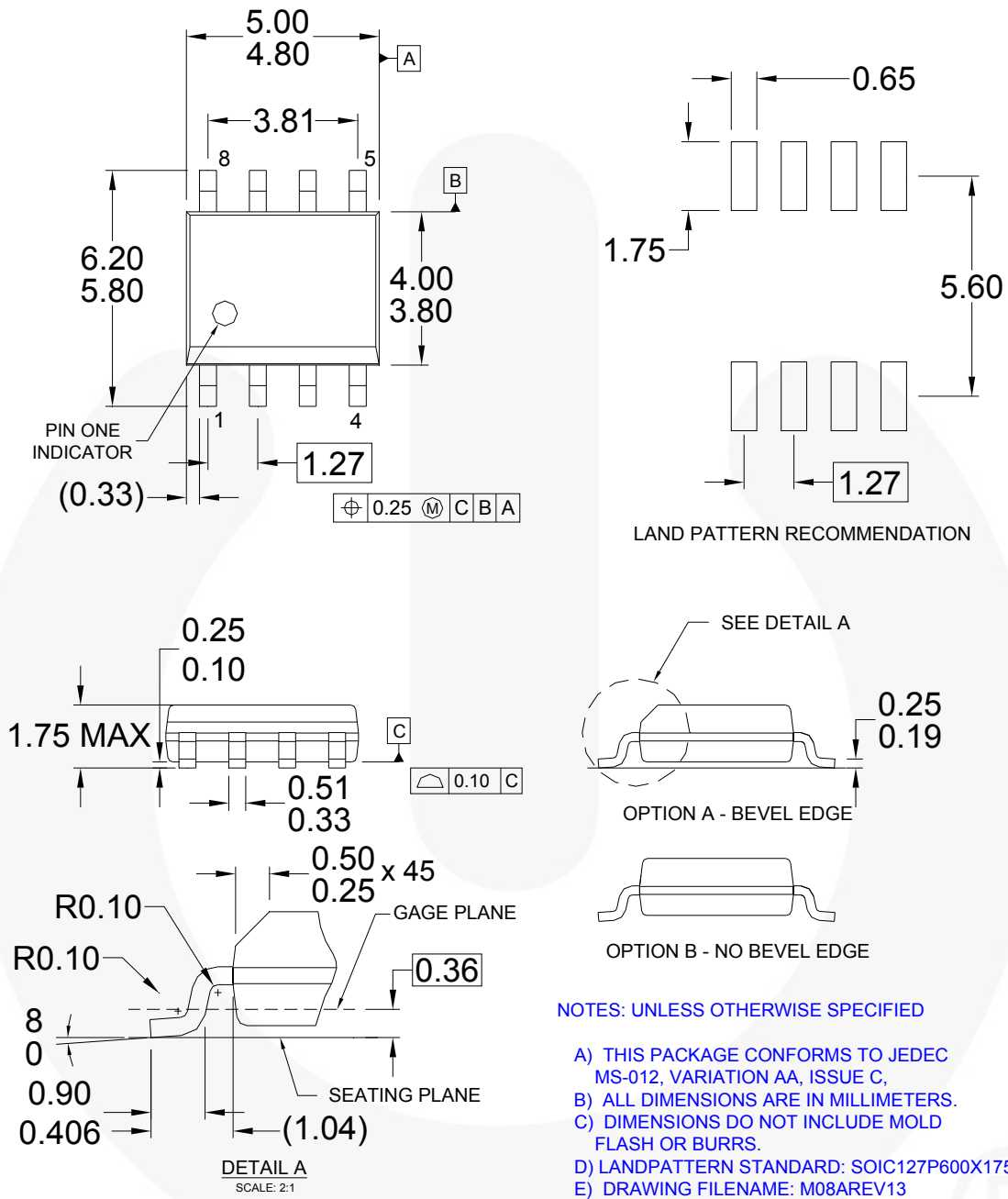

Figure 54. 8-Lead SOIC





Package drawings are provided as a service to customers considering Fairchild components. Drawings may change in any manner without notice. Please note the revision and/or date on the drawing and contact a Fairchild Semiconductor representative to verify or obtain the most recent revision. Package specifications do not expand the terms of Fairchild's worldwide terms and conditions, specifically the warranty therein, which covers Fairchild products.

Always visit Fairchild Semiconductor's online packaging area for the most recent package drawings:
<http://www.fairchildsemi.com/packaging/>.



TRADEMARKS

The following includes registered and unregistered trademarks and service marks, owned by Fairchild Semiconductor and/or its global subsidiaries, and is not intended to be an exhaustive list of all such trademarks.

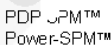
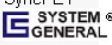
- | | | | |
|---|---|---|---|
| Build it Now™ | F-PFST™ | PowerTrench® | The Power Franchise® |
| CorePLUS™ | FRFET® | Programmable Active Droop™ |  |
| CorePOWER™ | Global Power Resource SM | QFET® | TinyBoost™ |
| CROSSVOLT™ | Green FPS™ | QST™ | TinyBuck™ |
| CTL™ | Green FPS™ e-Series™ | Quiet Series™ | TinyLogic® |
| Current Transfer Logic™ | GTO™ | RapidConfigure™ | TINYOPTO™ |
| EcoSPARK® | IntelliMAX™ |  | TinyPower™ |
| EfficientMax™ | ISOPLANAR™ | Saving our world, 1mW/W at a time™ | TinyPWM™ |
| EZSWTCH™ * | MegaBuck™ | SmartMax™ | TinyWire™ |
|  | MICROCOUPLER™ | SMART START™ | μSerDes™ |
|  | MicroFET™ | SFM® |  |
| Fairchild® | MillerDrive™ | STEALTH™ | UHC® |
| Fairchild Semiconductor® | MotionMax™ | SuperFET™ | Ultra FRFET™ |
| FACT Quiet Series™ | Motion-SPM™ | SuperSOT™.3 | UniFET™ |
| FACT® | OPTOLOGIC® | SuperSOT™.6 | VCX™ |
| FAST® | OPTOPLANAR® | SuperSOT™.8 | VisualMax™ |
| FastvCore™ |  | SupreMOS™ | |
| FlashWriter® * | Power-SPM™ | SyncFET™ | |
| FPS™ | |  | |

* EZSWTCH™ and FlashWriter® are trademarks of System General Corporation, used under license by Fairchild Semiconductor.

DISCLAIMER

FAIRCHILD SEMICONDUCTOR RESERVES THE RIGHT TO MAKE CHANGES WITHOUT FURTHER NOTICE TO ANY PRODUCTS HEREIN TO IMPROVE RELIABILITY, FUNCTION, OR DESIGN. FAIRCHILD DOES NOT ASSUME ANY LIABILITY ARISING OUT OF THE APPLICATION OR USE OF ANY PRODUCT OR CIRCUIT DESCRIBED HEREIN; NEITHER DOES IT CONVEY ANY LICENSE UNDER ITS PATENT RIGHTS, NOR THE RIGHTS OF OTHERS. THESE SPECIFICATIONS DO NOT EXPAND THE TERMS OF FAIRCHILD'S WORLDWIDE TERMS AND CONDITIONS, SPECIFICALLY THE WARRANTY THEREIN, WHICH COVERS THESE PRODUCTS.

LIFE SUPPORT POLICY

FAIRCHILD'S PRODUCTS ARE NOT AUTHORIZED FOR USE AS CRITICAL COMPONENTS IN LIFE SUPPORT DEVICES OR SYSTEMS WITHOUT THE EXPRESS WRITTEN APPROVAL OF FAIRCHILD SEMICONDUCTOR CORPORATION.

As used herein:

1. Life support devices or systems are devices or systems which, (a) are intended for surgical implant into the body or (b) support or sustain life, and (c) whose failure to perform when properly used in accordance with instructions for use provided in the labeling, can be reasonably expected to result in a significant injury of the user.
2. A critical component in any component of a life support, device, or system whose failure to perform can be reasonably expected to cause the failure of the life support device or system, or to affect its safety or effectiveness.

ANTI-COUNTERFEITING POLICY

Fairchild Semiconductor Corporation's Anti-Counterfeiting Policy. Fairchild's Anti-Counterfeiting Policy is also stated on our external website, www.fairchildsemi.com, under Sales Support.

Counterfeiting of semiconductor parts is a growing problem in the industry. All manufacturers of semiconductor products are experiencing counterfeiting of their parts. Customers who inadvertently purchase counterfeit parts experience many problems such as loss of brand reputation, substandard performance, failed applications, and increased cost of production and manufacturing delays. Fairchild is taking strong measures to protect ourselves and our customers from the proliferation of counterfeit parts. Fairchild strongly encourages customers to purchase Fairchild parts either directly from Fairchild or from Authorized Fairchild Distributors who are listed by country on our web page cited above. Products customers buy either from Fairchild directly or from Authorized Fairchild Distributors are genuine parts, have full traceability, meet Fairchild's quality standards for handling and storage and provide access to Fairchild's full range of up-to-date technical and product information. Fairchild and our Authorized Distributors will stand behind all warranties and will appropriately address any warranty issues that may arise. Fairchild will not provide any warranty coverage or other assistance for parts bought from Unauthorized Sources. Fairchild is committed to combat this global problem and encourage our customers to do their part in stopping this practice by buying direct or from authorized distributors.

PRODUCT STATUS DEFINITIONS

Definition of Terms

Datasheet Identification	Product Status	Definition
Advance Information	Formative / In Design	Datasheet contains the design specifications for product development. Specifications may change in any manner without notice.
Preliminary	First Production	Datasheet contains preliminary data; supplementary data will be published at a later date. Fairchild Semiconductor reserves the right to make changes at any time without notice to improve design.
No Identification Needed	Full Production	Datasheet contains final specifications. Fairchild Semiconductor reserves the right to make changes at any time without notice to improve the design.
Obsolete	Not In Production	Datasheet contains specifications on a product that is discontinued by Fairchild Semiconductor. The datasheet is for reference information only.

Rev. I36