

INSULATED GATE BIPOLAR TRANSISTOR WITH
ULTRAFAST SOFT RECOVERY DIODE

IRGB15B60KD
IRGS15B60KD
IRGSL15B60KD

Features

- Low VCE (on) Non Punch Through IGBT Technology.
- Low Diode VF.
- 10µs Short Circuit Capability.
- Square RBSOA.
- Ultrasoft Diode Reverse Recovery Characteristics.
- Positive VCE (on) Temperature Coefficient.

Benefits

- Benchmark Efficiency for Motor Control.
- Rugged Transient Performance.
- Low EMI.
- Excellent Current Sharing in Parallel Operation.

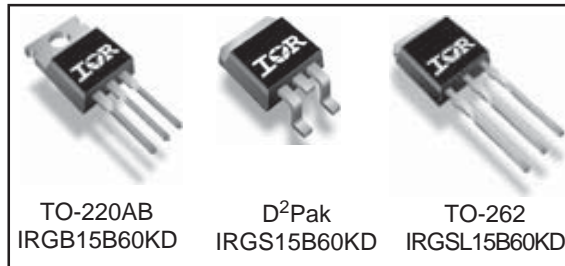
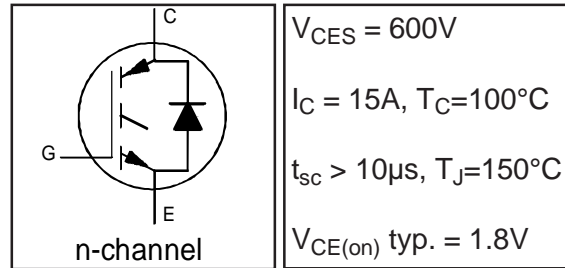

Absolute Maximum Ratings

	Parameter	Max.	Units
V_{CES}	Collector-to-Emitter Voltage	600	V
$I_C @ T_C = 25^\circ C$	Continuous Collector Current	31	A
$I_C @ T_C = 100^\circ C$	Continuous Collector Current	15	
I_{CM}	Pulsed Collector Current	62	
I_{LM}	Clamped Inductive Load Current	62	
$I_F @ T_C = 25^\circ C$	Diode Continuous Forward Current	31	
$I_F @ T_C = 100^\circ C$	Diode Continuous Forward Current	15	
I_{FM}	Diode Maximum Forward Current	64	
V_{GE}	Gate-to-Emitter Voltage	± 20	V
$P_D @ T_C = 25^\circ C$	Maximum Power Dissipation	208	W
$P_D @ T_C = 100^\circ C$	Maximum Power Dissipation	83	
T_J	Operating Junction and	-55 to +150	°C
T_{STG}	Storage Temperature Range		
	Soldering Temperature, for 10 sec.	300 (0.063 in. (1.6mm) from case)	

Thermal Resistance

	Parameter	Min.	Typ.	Max.	Units
$R_{\theta JC}$	Junction-to-Case - IGBT	—	—	0.6	°C/W
$R_{\theta JC}$	Junction-to-Case - Diode	—	—	2.1	
$R_{\theta CS}$	Case-to-Sink, flat, greased surface	—	0.50	—	
$R_{\theta JA}$	Junction-to-Ambient, typical socket mount①	—	—	62	
$R_{\theta JA}$	Junction-to-Ambient (PCB Mount, steady state)②	—	—	40	
Wt	Weight	—	1.44	—	g

IRG/B/S/SL15B60KD

International
IRF Rectifier

Electrical Characteristics @ $T_J = 25^\circ\text{C}$ (unless otherwise specified)

	Parameter	Min.	Typ.	Max.	Units	Conditions	Ref.Fig.
$V_{(BR)CES}$	Collector-to-Emitter Breakdown Voltage	600	—	—	V	$V_{GE} = 0V, I_C = 500\mu A$	
$\Delta V_{(BR)CES}/\Delta T_J$	Temperature Coeff. of Breakdown Voltage	—	0.3	—	V/°C	$V_{GE} = 0V, I_C = 1.0mA, (25^\circ\text{C}-150^\circ\text{C})$	
$V_{CE(on)}$	Collector-to-Emitter Saturation Voltage	1.5	1.80	2.20	V	$I_C = 15A, V_{GE} = 15V$	5, 6,7
		—	2.05	2.50		$I_C = 15A, V_{GE} = 15V, T_J = 125^\circ\text{C}$	9, 10,11
		—	2.10	2.60		$I_C = 15A, V_{GE} = 15V, T_J = 150^\circ\text{C}$	
$V_{GE(th)}$	Gate Threshold Voltage	3.5	4.5	5.5	V	$V_{CE} = V_{GE}, I_C = 250\mu A$	9, 10,11
$\Delta V_{GE(th)}/\Delta T_J$	Temperature Coeff. of Threshold Voltage	—	-10	—	mV/°C	$V_{CE} = V_{GE}, I_C = 1.0mA, (25^\circ\text{C}-150^\circ\text{C})$	12
g_{fe}	Forward Transconductance	—	10.6	—	S	$V_{CE} = 50V, I_C = 20A, PW=80\mu s$	
I_{CES}	Zero Gate Voltage Collector Current	—	5.0	150	μA	$V_{GE} = 0V, V_{CE} = 600V$	
		—	500	1000		$V_{GE} = 0V, V_{CE} = 600V, T_J = 150^\circ\text{C}$	
V_{FM}	Diode Forward Voltage Drop	—	1.20	1.45	V	$I_C = 15A$	8
		—	1.20	1.45		$I_C = 15A, T_J = 150^\circ\text{C}$	
I_{GES}	Gate-to-Emitter Leakage Current	—	—	± 100	nA	$V_{GE} = \pm 20V$	

Switching Characteristics @ $T_J = 25^\circ\text{C}$ (unless otherwise specified)

	Parameter	Min.	Typ.	Max.	Units	Conditions	Ref.Fig.
Q_g	Total Gate Charge (turn-on)	—	56	84	nC	$I_C = 15A$	CT1
Q_{ge}	Gate - Emitter Charge (turn-on)	—	7.0	10		$V_{CC} = 400V$	
Q_{gc}	Gate - Collector Charge (turn-on)	—	26	39		$V_{GE} = 15V$	
E_{on}	Turn-On Switching Loss	—	220	330	μJ	$I_C = 15A, V_{CC} = 400V$	CT4
E_{off}	Turn-Off Switching Loss	—	340	455		$V_{GE} = 15V, R_G = 22\Omega, L = 200\mu H$	
E_{tot}	Total Switching Loss	—	560	785		$L_s = 150nH, T_J = 25^\circ\text{C}$ ③	
$t_{d(on)}$	Turn-On Delay Time	—	34	44	ns	$I_C = 15A, V_{CC} = 400V$	CT4
t_r	Rise Time	—	16	22		$V_{GE} = 15V, R_G = 22\Omega, L = 200\mu H$	
$t_{d(off)}$	Turn-Off Delay Time	—	184	200		$L_s = 150nH, T_J = 25^\circ\text{C}$	
t_f	Fall Time	—	20	26			
E_{on}	Turn-On Switching Loss	—	355	470	μJ	$I_C = 15A, V_{CC} = 400V$	CT4
E_{off}	Turn-Off Switching Loss	—	490	600		$V_{GE} = 15V, R_G = 22\Omega, L = 200\mu H$	
E_{tot}	Total Switching Loss	—	835	1070		$L_s = 150nH, T_J = 150^\circ\text{C}$ ③	
$t_{d(on)}$	Turn-On Delay Time	—	34	44	ns	$I_C = 15A, V_{CC} = 400V$	14, 16
t_r	Rise Time	—	18	25		$V_{GE} = 15V, R_G = 22\Omega, L = 200\mu H$	
$t_{d(off)}$	Turn-Off Delay Time	—	203	226		$L_s = 150nH, T_J = 150^\circ\text{C}$	
t_f	Fall Time	—	28	36			
C_{ies}	Input Capacitance	—	850	—	pF	$V_{GE} = 0V$	
C_{oes}	Output Capacitance	—	75	—		$V_{CC} = 30V$	
C_{res}	Reverse Transfer Capacitance	—	35	—		$f = 1.0MHz$	
RBSOA	Reverse Bias Safe Operating Area	FULL SQUARE				$T_J = 150^\circ\text{C}, I_C = 62A, V_p = 600V$ $V_{CC} = 500V, V_{GE} = +15V \text{ to } 0V, R_G = 22\Omega$	4 CT2
SCSOA	Short Circuit Safe Operating Area	10	—	—	μs	$T_J = 150^\circ\text{C}, V_p = 600V, R_G = 22\Omega$ $V_{CC} = 360V, V_{GE} = +15V \text{ to } 0V$	CT3 WF4
E_{rec}	Reverse Recovery energy of the diode	—	540	720	μJ	$T_J = 150^\circ\text{C}$	17,18,19
t_{rr}	Diode Reverse Recovery time	—	92	111	ns	$V_{CC} = 400V, I_F = 15A, L = 200\mu H$	20,21
I_{rr}	Diode Peak Reverse Recovery Current	—	29	33	A	$V_{GE} = 15V, R_G = 22\Omega, L_s = 150nH$	CT4,WF3

Note ① to ③ are on page 15

8

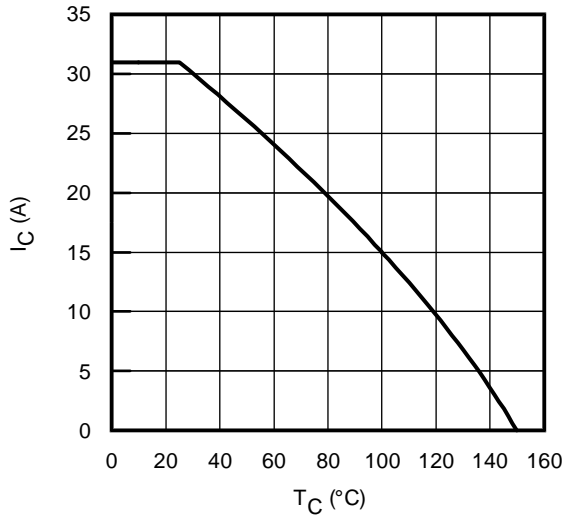

Fig. 1 - Maximum DC Collector Current vs. Case Temperature

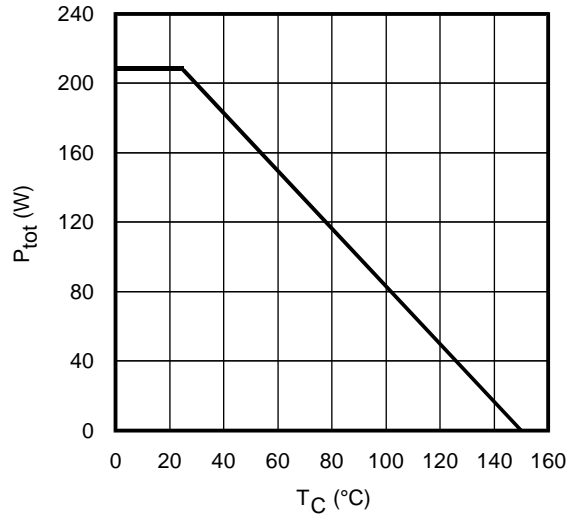

Fig. 2 - Power Dissipation vs. Case Temperature

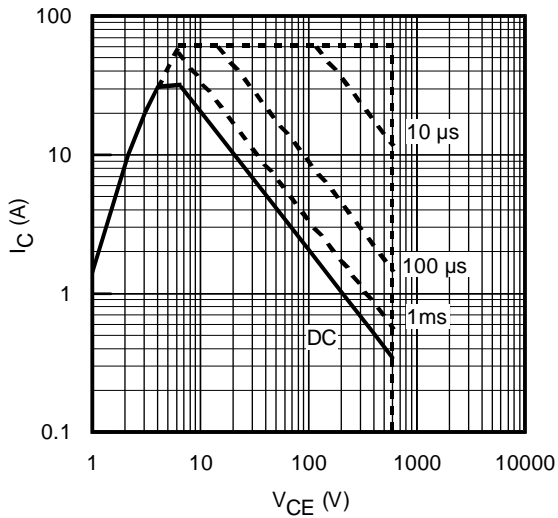

Fig. 3 - Forward SOA
 $T_C = 25^\circ\text{C}; T_J \leq 150^\circ\text{C}$

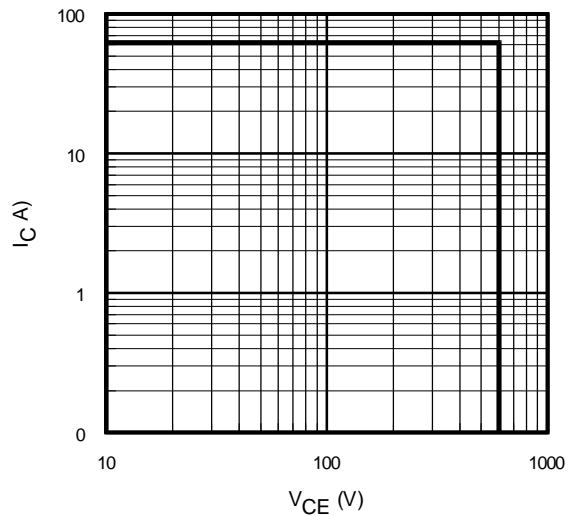

Fig. 4 - Reverse Bias SOA
 $T_J = 150^\circ\text{C}; V_{GE} = 15\text{V}$

IRG/B/S/SL15B60KD

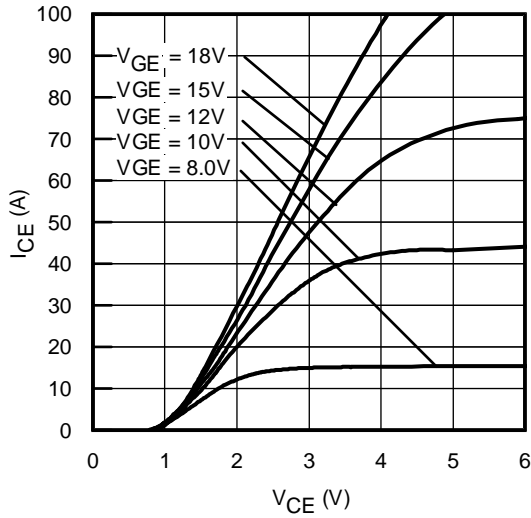

Fig. 5 - Typ. IGBT Output Characteristics
 $T_J = -40^\circ\text{C}$; $t_p = 300\mu\text{s}$

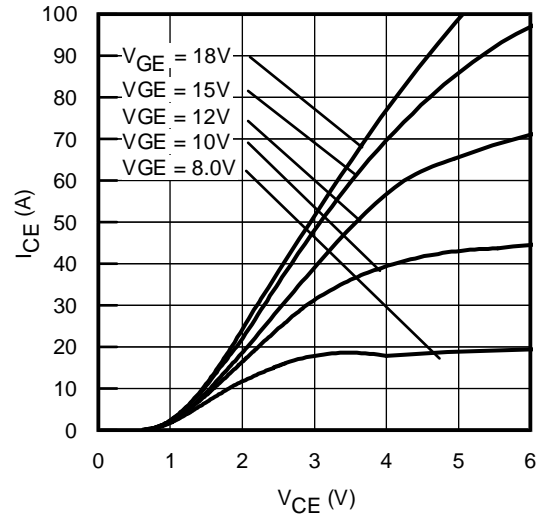

Fig. 6 - Typ. IGBT Output Characteristics
 $T_J = 25^\circ\text{C}$; $t_p = 300\mu\text{s}$

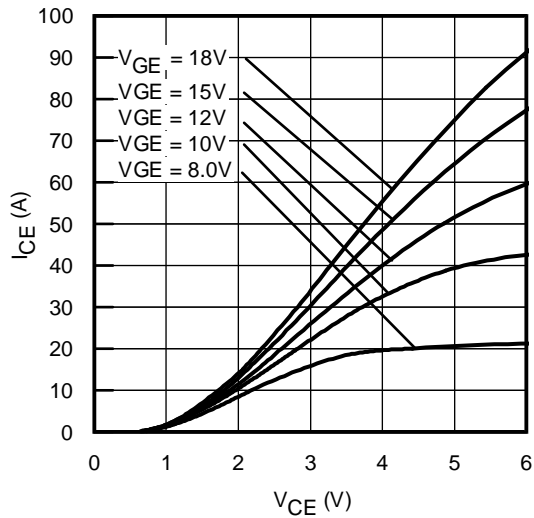

Fig. 7 - Typ. IGBT Output Characteristics
 $T_J = 150^\circ\text{C}$; $t_p = 300\mu\text{s}$

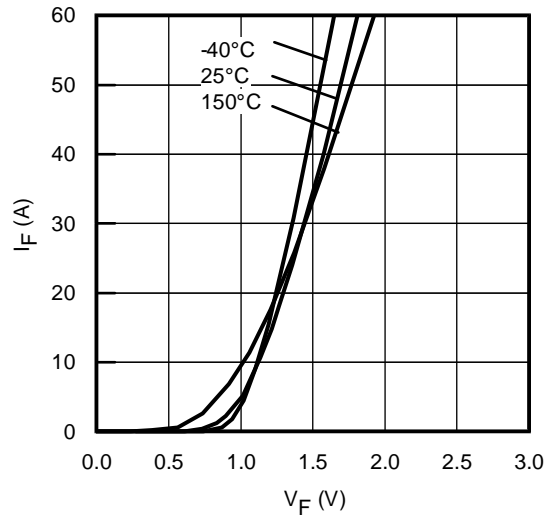

Fig. 8 - Typ. Diode Forward Characteristics
 $t_p = 80\mu\text{s}$

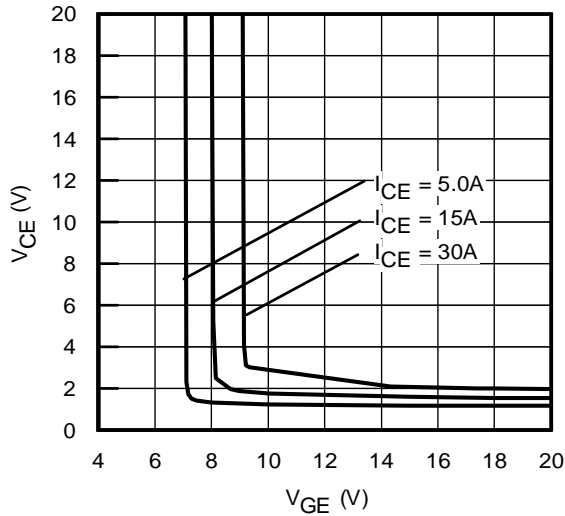

Fig. 9 - Typical V_{CE} vs. V_{GE}
 $T_J = -40^\circ\text{C}$

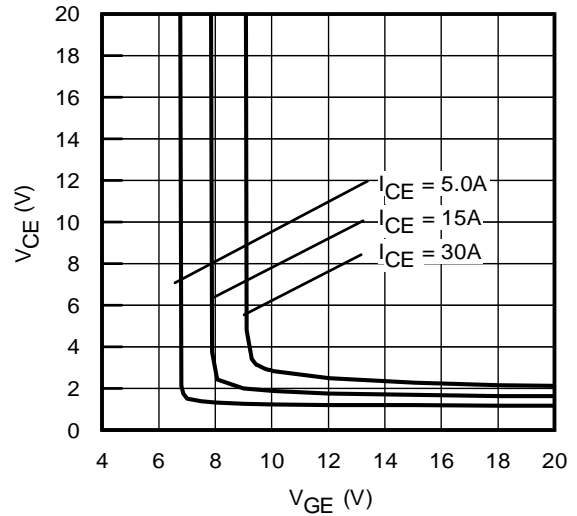

Fig. 10 - Typical V_{CE} vs. V_{GE}
 $T_J = 25^\circ\text{C}$

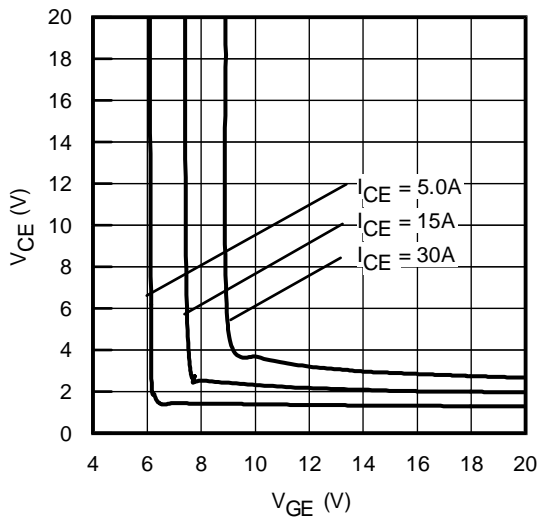

Fig. 11 - Typical V_{CE} vs. V_{GE}
 $T_J = 150^\circ\text{C}$

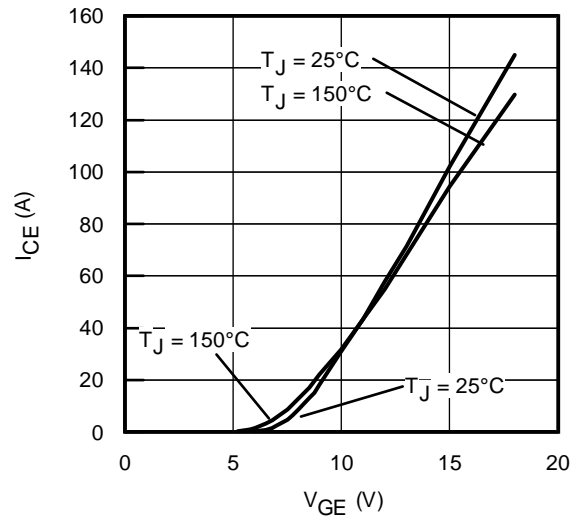

Fig. 12 - Typ. Transfer Characteristics
 $V_{CE} = 50\text{V}$; $t_p = 10\mu\text{s}$

IRG/B/S/SL15B60KD

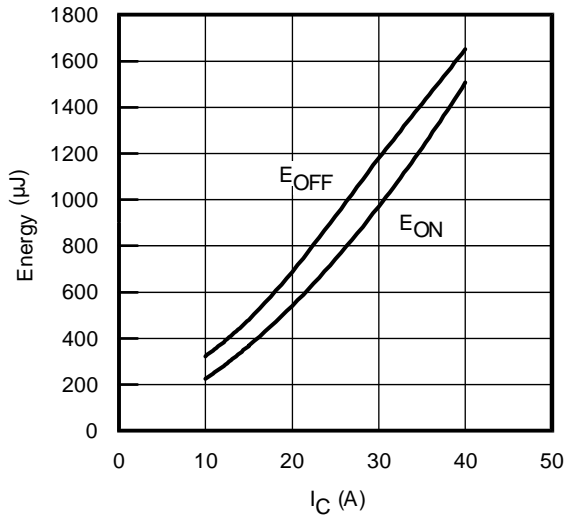

Fig. 13 - Typ. Energy Loss vs. I_C
 $T_J = 150^\circ\text{C}$; $L=200\mu\text{H}$; $V_{CE}= 400\text{V}$
 $R_G= 22\Omega$; $V_{GE}= 15\text{V}$

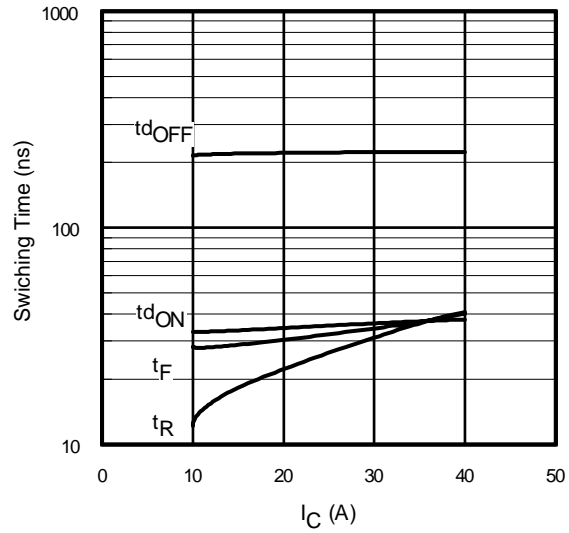

Fig. 14 - Typ. Switching Time vs. I_C
 $T_J = 150^\circ\text{C}$; $L=200\mu\text{H}$; $V_{CE}= 400\text{V}$
 $R_G= 22\Omega$; $V_{GE}= 15\text{V}$

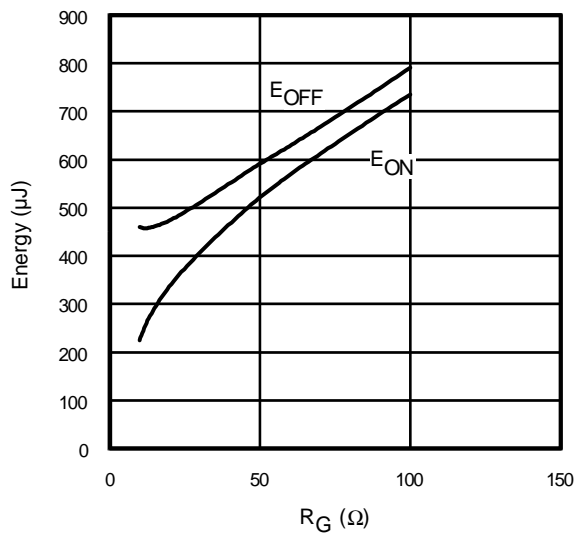

Fig. 15 - Typ. Energy Loss vs. R_G
 $T_J = 150^\circ\text{C}$; $L=200\mu\text{H}$; $V_{CE}= 400\text{V}$
 $I_{CE}= 15\text{A}$; $V_{GE}= 15\text{V}$

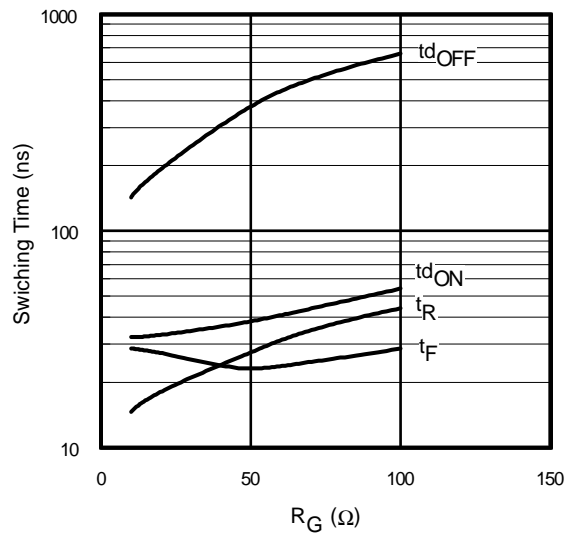

Fig. 16- Typ. Switching Time vs. R_G
 $T_J = 150^\circ\text{C}$; $L=200\mu\text{H}$; $V_{CE}= 600\text{V}$
 $I_{CE}= 15\text{A}$; $V_{GE}= 15\text{V}$

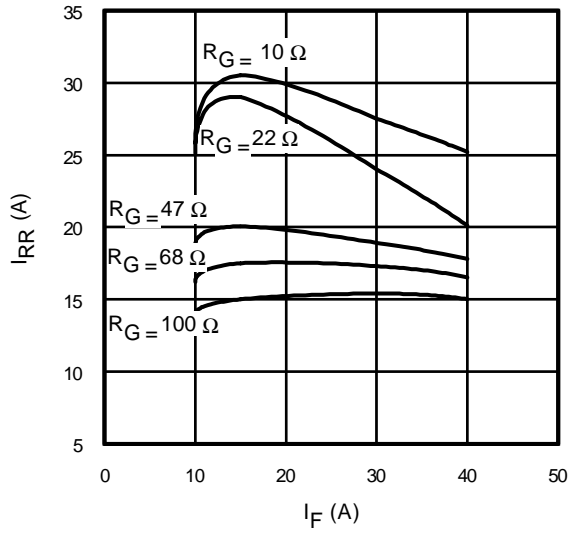

Fig. 17 - Typical Diode I_{RR} vs. I_F
 $T_J = 150^\circ\text{C}$

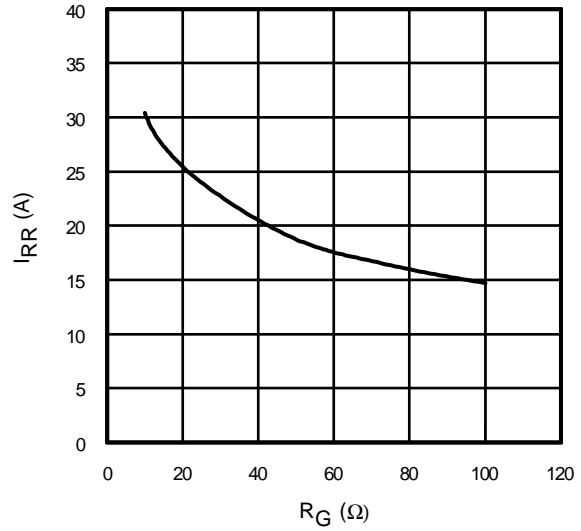

Fig. 18 - Typical Diode I_{RR} vs. R_G
 $T_J = 150^\circ\text{C}; I_F = 15\text{A}$

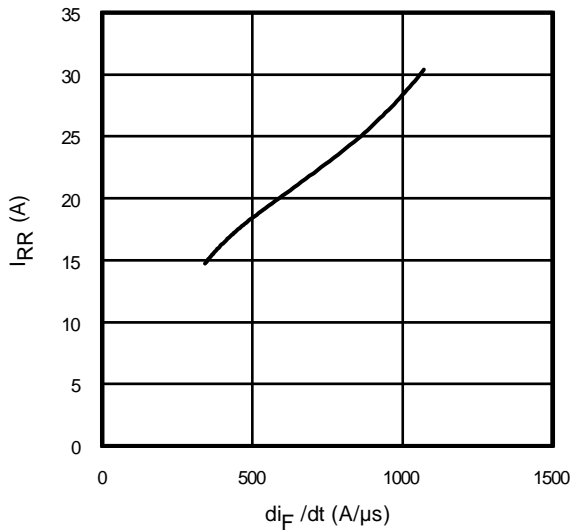

Fig. 19 - Typical Diode I_{RR} vs. di_F/dt
 $V_{CC} = 400\text{V}; V_{GE} = 15\text{V};$
 $I_{CE} = 15\text{A}; T_J = 150^\circ\text{C}$

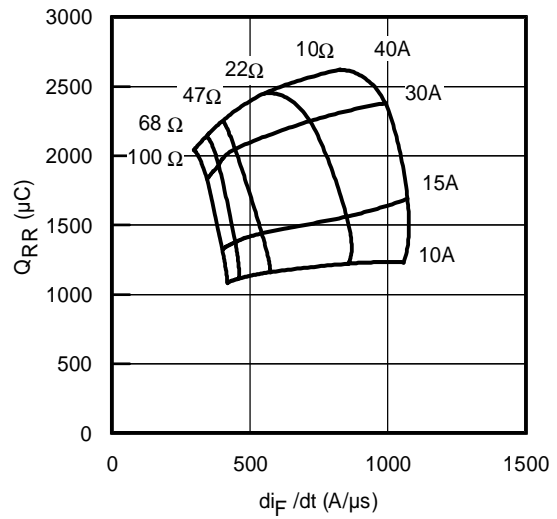

Fig. 20 - Typical Diode Q_{RR}
 $V_{CC} = 400\text{V}; V_{GE} = 15\text{V}; T_J = 150^\circ\text{C}$

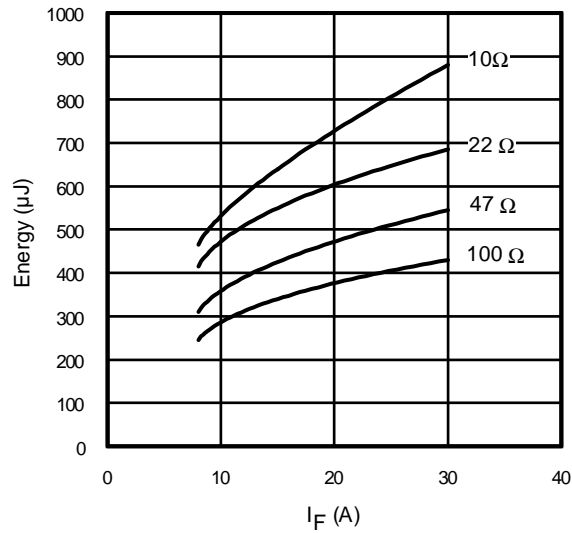

Fig. 21 - Typical Diode E_{RR} vs. I_F
 $T_J = 150^\circ\text{C}$

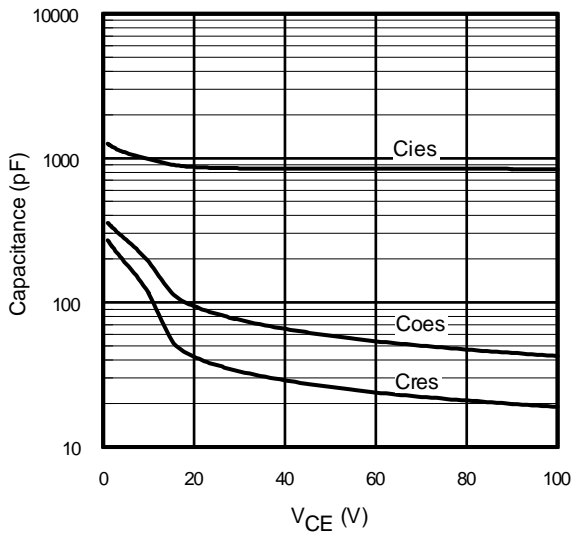

Fig. 22- Typ. Capacitance vs. V_{CE}
 $V_{GE} = 0\text{V}$; $f = 1\text{MHz}$

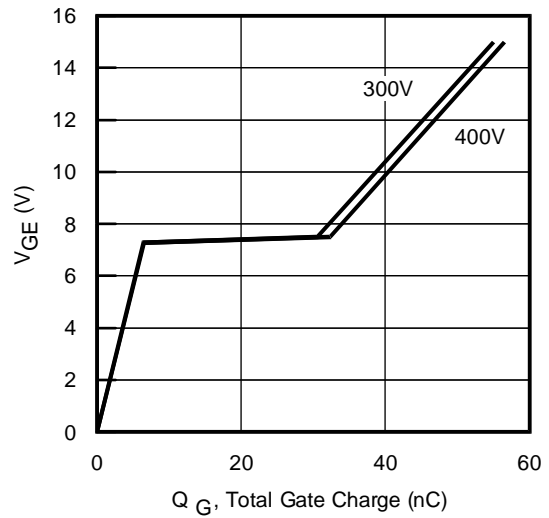

Fig. 23 - Typical Gate Charge vs. V_{GE}
 $I_{CE} = 15\text{A}$; $L = 600\ \mu\text{H}$

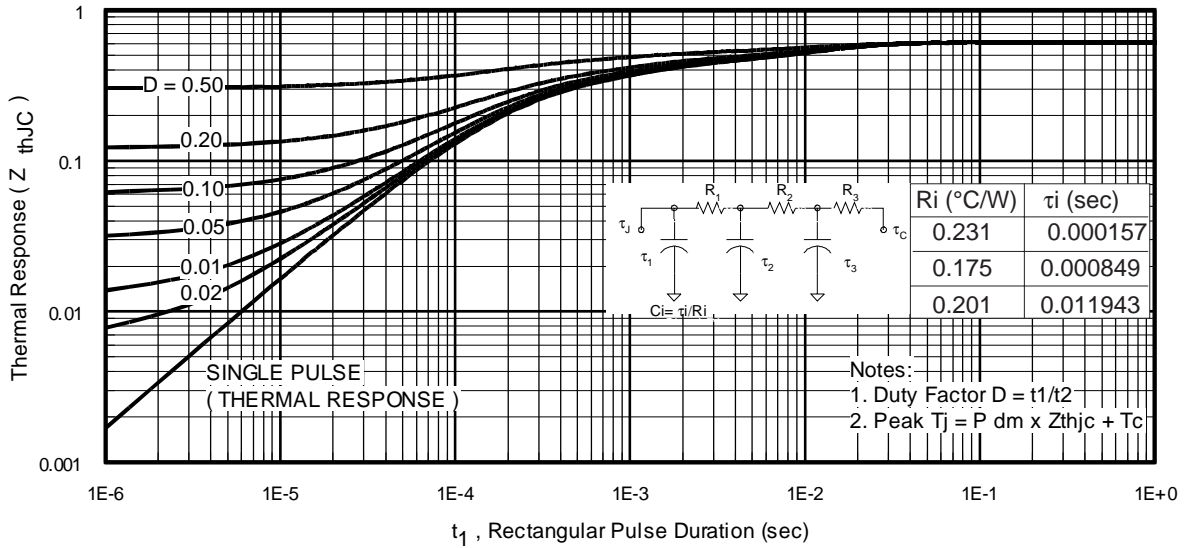

Fig 24. Maximum Transient Thermal Impedance, Junction-to-Case (IGBT)

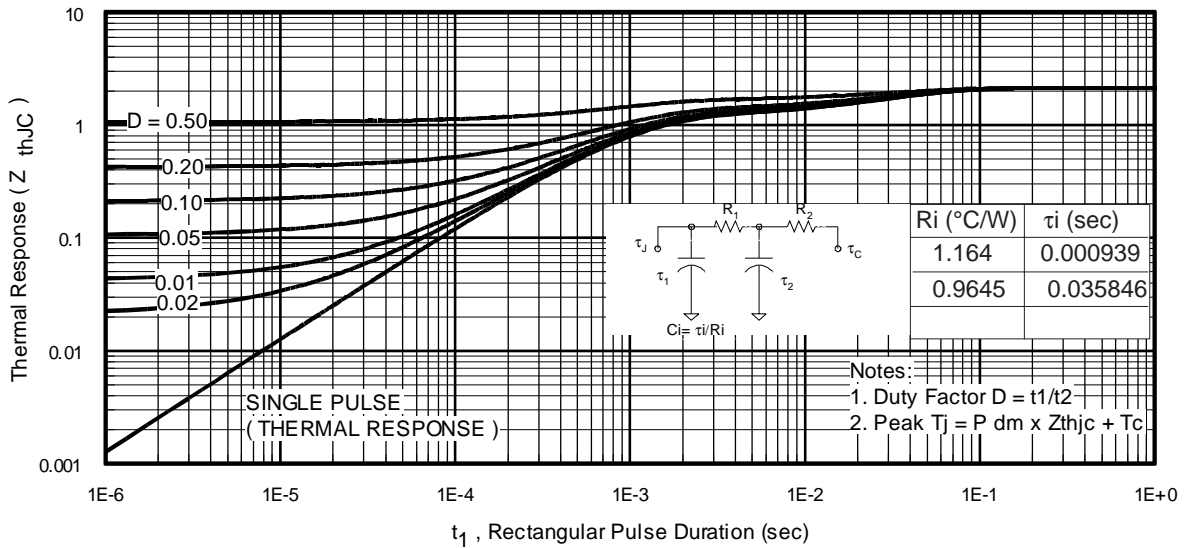

Fig 25. Maximum Transient Thermal Impedance, Junction-to-Case (DIODE)

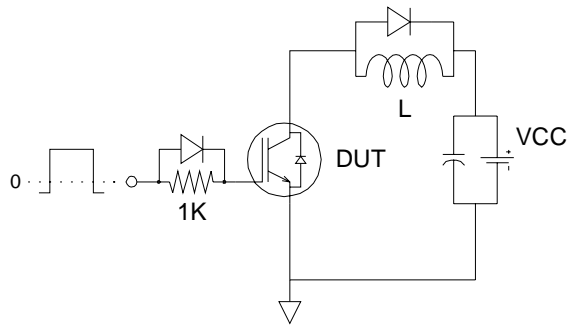

Fig.C.T.1 - Gate Charge Circuit (turn-off)

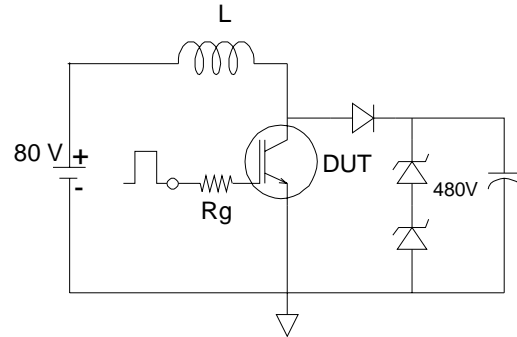

Fig.C.T.2 - RBSOA Circuit

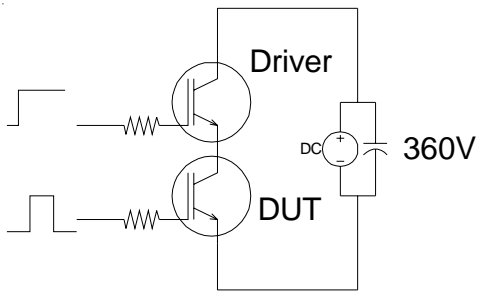

Fig.C.T.3 - S.C.SOA Circuit

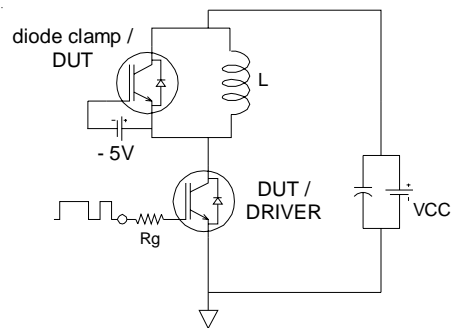

Fig.C.T.4 - Switching Loss Circuit

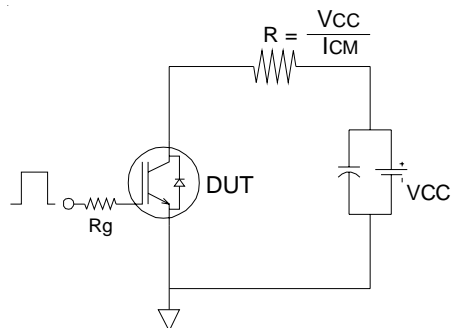
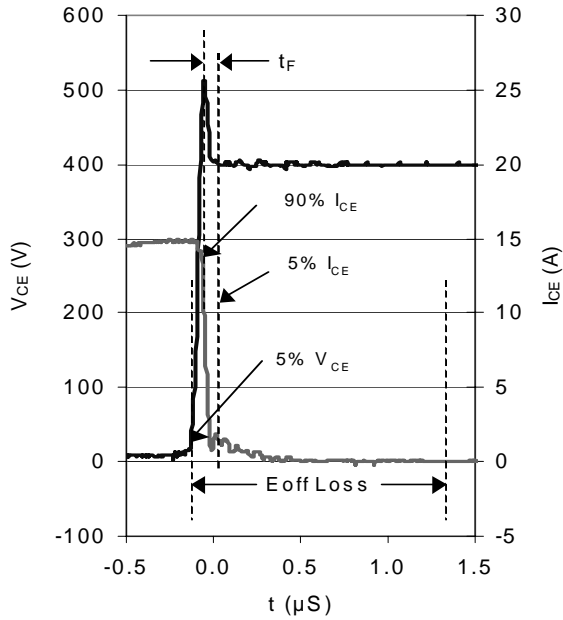
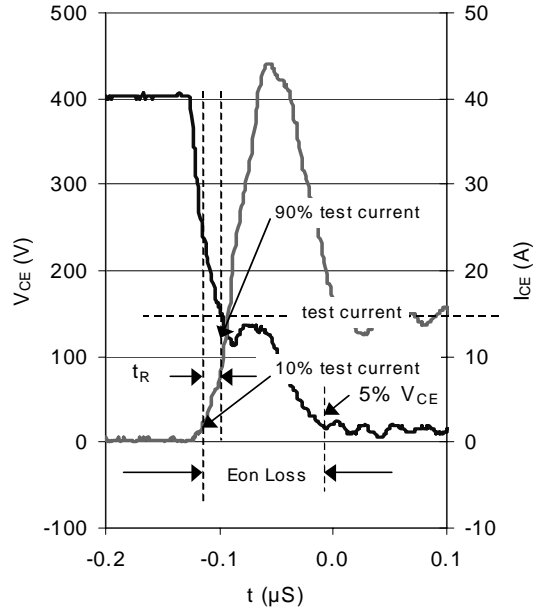

Fig.C.T.5 - Resistive Load Circuit



WF.1- Typ. Turn-off Loss
@ $T_J = 150^\circ\text{C}$ using CT.4



WF.2- Typ. Turn-on Loss
@ $T_J = 150^\circ\text{C}$ using Fig. CT.4

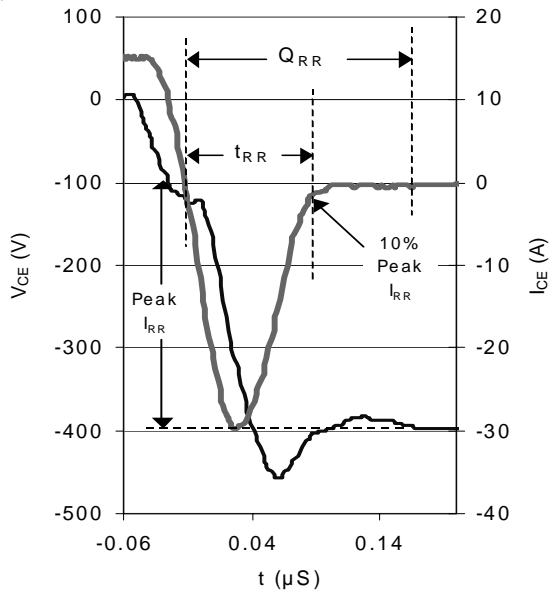

WF.3- Typ. Reverse Recovery
@ $T_J = 150^\circ\text{C}$ using CT.4

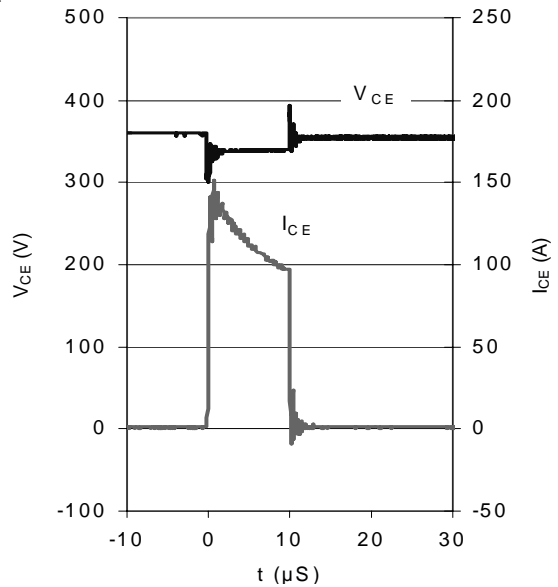

WF.4- Typ. Short Circuit
@ $T_J = 150^\circ\text{C}$ using CT.3

IRG/B/S/SL15B60KD



TO-220AB Package Outline

Dimensions are shown in millimeters (inches)

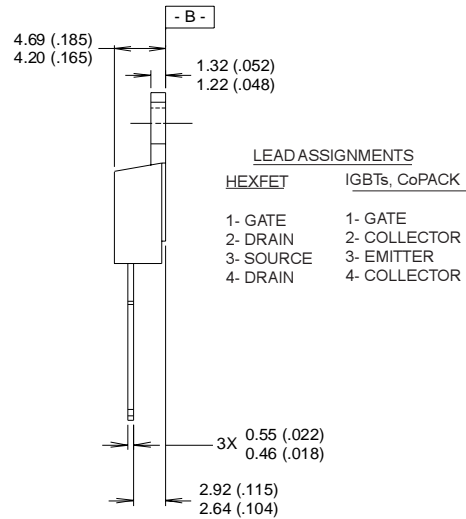
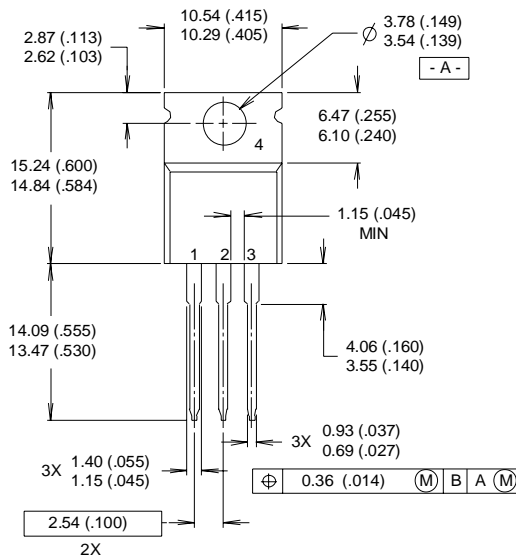

NOTES:

- 1 DIMENSIONING & TOLERANCING PER ANSI Y14.5M, 1982.
- 2 CONTROLLING DIMENSION : INCH

- 3 OUTLINE CONFORMS TO JEDEC OUTLINE TO-220AB.
- 4 HEATSINK & LEAD MEASUREMENTS DO NOT INCLUDE BURRS.

TO-220AB Part Marking Information

EXAMPLE: THIS IS AN IRF1010
 LOT CODE 1789
 ASSEMBLED ON WW 19, 1997
 IN THE ASSEMBLY LINE "C"

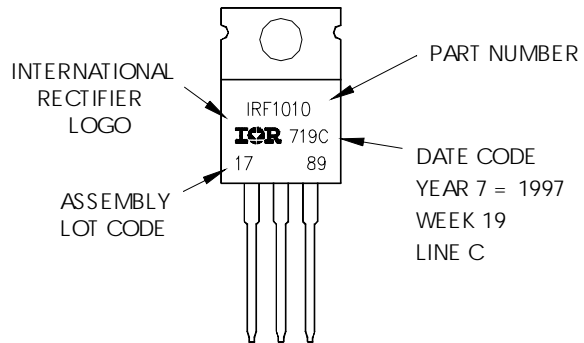

D²Pak Package Outline

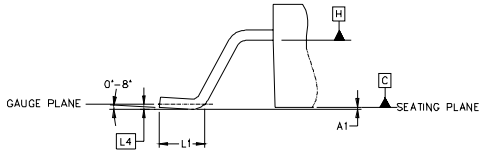

DETAIL "A"
 ROTATED 90°
 SCALE 8:1

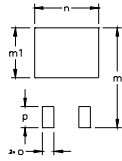
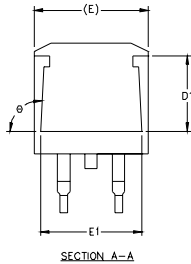
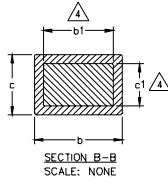

FOOT PRINT
 SCALE 2:1

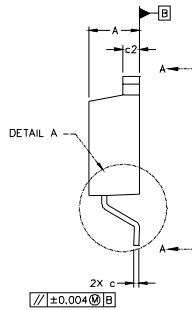
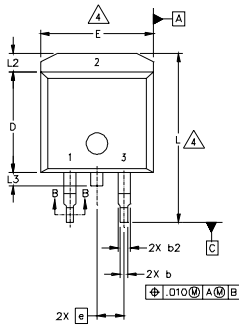

NOTES:

1. DIMENSIONING AND TOLERANCING PER ASME Y14.5M-1994
2. DIMENSIONS ARE SHOWN IN MILLIMETERS [INCHES].
3. DIMENSION D & E DO NOT INCLUDE MOLD FLASH. MOLD FLASH SHALL NOT EXCEED 0.127 [0.005"] PER SIDE. THESE DIMENSIONS ARE MEASURED AT THE OUTMOST EXTREMES OF THE PLASTIC BODY.
4. DIMENSION b1 AND c1 APPLY TO BASE METAL ONLY.
5. CONTROLLING DIMENSION: INCH.

IRG/B/S/SL15B60KD

SYMBOL	DIMENSIONS				NOTES
	MILLIMETERS		INCHES		
	MIN.	MAX.	MIN.	MAX.	
A	4.06	4.83	.160	.190	4
A1		0.127		.005	
b	0.51	0.99	.020	.039	
b1	0.51	0.89	.020	.035	
b2	1.14	1.40	.045	.055	
c	0.43	0.63	.017	.025	4
c1	0.38	0.74	.015	.029	
c2	1.14	1.40	.045	.055	
D	8.51	9.65	.335	.380	3
D1	5.33		.210		3
E	9.65	10.67	.380	.420	
E1	6.22		.245		
e	2.54 BSC		.100 BSC		
L	14.61	15.88	.575	.625	
L1	1.78	2.79	.070	.110	
L2		1.65		.065	
L3	1.27	1.78	.050	.070	
L4	0.25 BSC		.010 BSC		
m	17.78		.700		
m1	8.89		.350		
n	11.43		.450		
o	2.08		.082		
p	3.81		.150		
θ	90°	93°	90°	93°	

LEAD ASSIGNMENTS

HEXFET	IGBTs, CoPACK	DIODES
1.- GATE	1.- GATE	1.- ANODE *
2.- DRAIN	2.- COLLECTOR	2.- CATHODE
3.- SOURCE	3.- EMITTER	3.- ANODE

* PART DEPENDENT.

D²Pak Part Marking Information

EXAMPLE: THIS IS AN IRF530S WITH
 LOT CODE 8024
 ASSEMBLED ON WW02, 2000
 IN THE ASSEMBLY LINE "L"

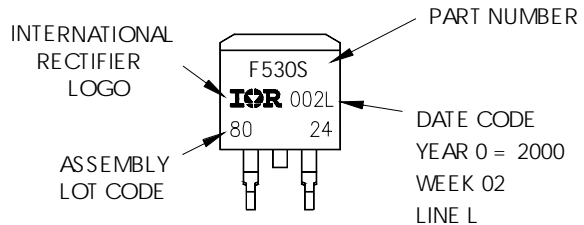

IRG/B/S/SL15B60KD

International
IRF Rectifier

TO-262 Package Outline

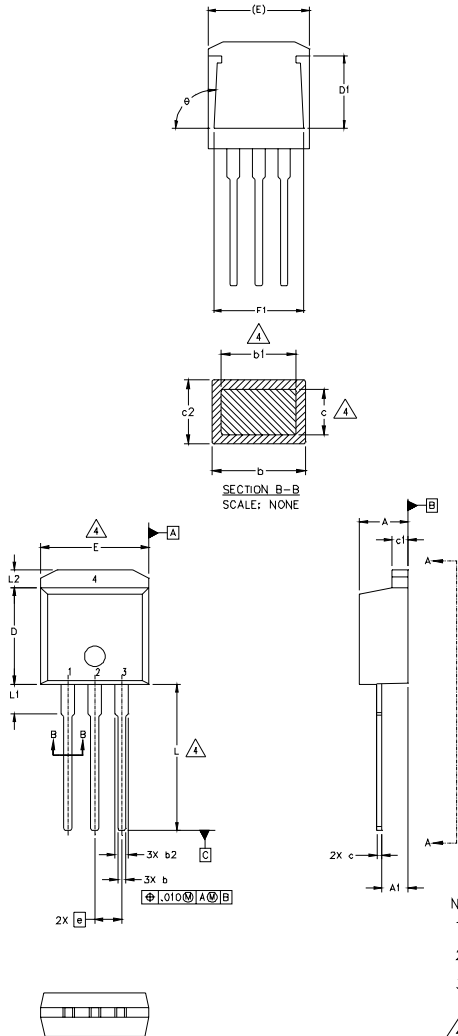

SYMBOL	DIMENSIONS				NOTES
	MILLIMETERS		INCHES		
	MIN.	MAX.	MIN.	MAX.	
A	4.06	4.83	.160	.190	
A1	2.03	2.92	.080	.115	
b	0.51	0.99	.020	.039	
b1	0.51	0.89	.020	.035	4
b2	1.14	1.40	.045	.055	
c	0.38	0.63	.015	.025	4
c1	1.14	1.40	.045	.055	
c2	0.43	.063	.017	.029	
D	8.51	9.65	.335	.380	3
D1	5.33		.210		
E	9.65	10.67	.380	.420	3
E1	6.22		.245		
e	2.54 BSC		.100 BSC		
L	13.46	14.09	.530	.555	
L1	3.56	3.71	.140	.146	
L2		1.65		.065	

LEAD ASSIGNMENTS

HEXFET	IGBT
1.- GATE	1- GATE
2.- DRAIN	2- COLLECTOR
3.- SOURCE	3- EMITTER
4.- DRAIN	4- COLLECTOR

NOTES:

1. DIMENSIONING AND TOLERANCING PER ASME Y14.5M-1994
2. DIMENSIONS ARE SHOWN IN MILLIMETERS [INCHES].
3. DIMENSION D & E DO NOT INCLUDE MOLD FLASH. MOLD FLASH SHALL NOT EXCEED 0.127 [".005"] PER SIDE. THESE DIMENSIONS ARE MEASURED AT THE OUTMOST EXTREMES OF THE PLASTIC BODY.
4. DIMENSION b1 AND c1 APPLY TO BASE METAL ONLY.
5. CONTROLLING DIMENSION: INCH.

TO-262 Part Marking Information

EXAMPLE: THIS IS AN IRL3103L
LOT CODE 1789
ASSEMBLED ON WW 19, 1997
IN THE ASSEMBLY LINE "C"

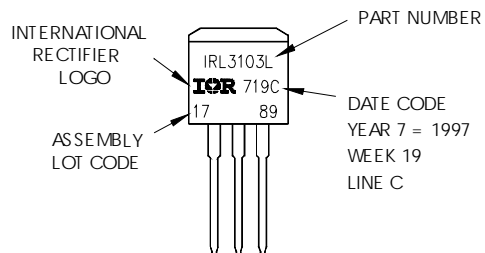

D²Pak Tape & Reel Information

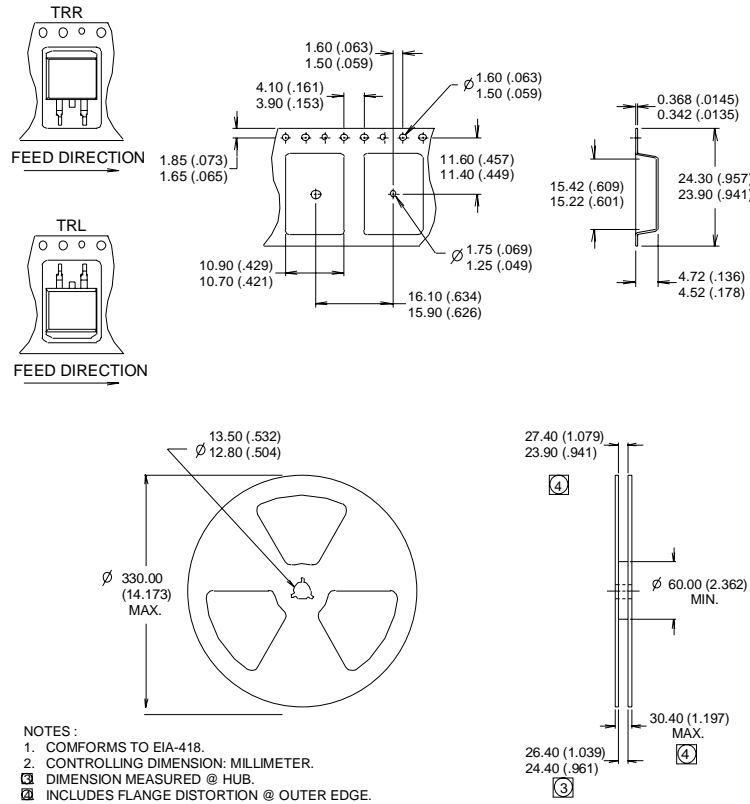

Notes:

- ① This is only applied to TO-220AB package
- ② This is applied to D²Pak, when mounted on 1" square PCB (FR-4 or G-10 Material).
For recommended footprint and soldering techniques refer to application note #AN-994.
- ③ Energy losses include "tail" and diode reverse recovery.

TO-220 package is not recommended for Surface Mount Application

Data and specifications subject to change without notice.
 This product has been designed and qualified for Industrial market.
 Qualification Standards can be found on IR's Web site.

International
IR Rectifier

IR WORLD HEADQUARTERS: 233 Kansas St., El Segundo, California 90245, USA Tel: (310) 252-7105
 TAC Fax: (310) 252-7903

Visit us at www.irf.com for sales contact information. 6/02