

- EP10 SMD Package
- Meets the specification for supplemental insulation per: UL60950-1, CSA60950-1, EN60950-1, IEC60950-1 with a working voltage of 250V
- Operating Temperature range: -40°C to +85°C
- Maximum reflow temperature: 250°C/-5°C for 20-40 seconds (Refer to IPC/JEDEC J-STD-020C Standard)

Electrical Specifications @25°C						
Turn Ratio (1-4):(8-5), (2+3, 6+7 short)		Inductance @ 10KHz, 0.1V (1-4), (2+3 short)		Leakage Inductance @ 100KHz, 0.1V (1-4) (2+3, 5+6+7+8 short)		Interwinding Capacitance @ 100KHz, 0.1V (1-8) (1+2+3+4, 5+6+7+8 short)
2:1±2%		1400uH±10%		1.0uH max.		104pF max.
DCR @ 10KHz, 0.1 V (1-4) (2+3 short)	DCR @ 10KHz, 0.1 V (8-5) (6+7 short)	THD Line Side		HI-POT (1-8) (1+2+3+4, 5+6+7+8 short)	Longitudinal Balance	
		25KHz/2Vp	25KHz/5.5Vp		12MHz	30MHz
2.0Ω max.	1.20Ω max.	-88dB max.	-85dB max.	1875Vac /0.5mA/1sec.	41dB min.	33dB min.

All specifications subject to change without notice.

**MECHANICAL**

**Dimension**

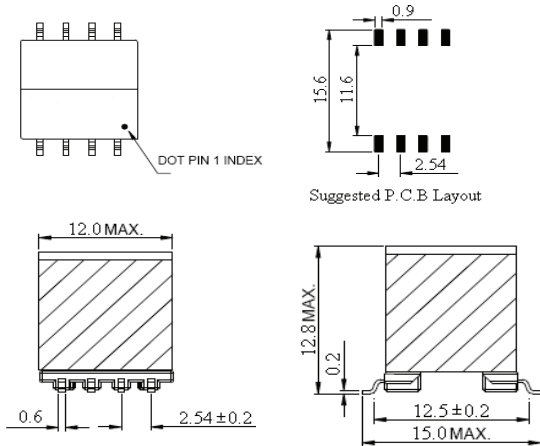

**Marking**



Remark:  
YYWW=DATE CODE  
YY=YEAR; WW=WEEK

**SCHEMATICS**

