

Spezifikation für Freigabe / specification for release

Kunde / customer : _____
 Artikelnummer / part number : **744771008**

LF



Bezeichnung : **SPEICHERDROSSEL WE-PD**
 description : **POWER-CHOKE WE-PD**

WÜRTH ELEKTRONIK

DATUM / DATE : 2005-01-12

A Mechanische Abmessungen / Dimensions :

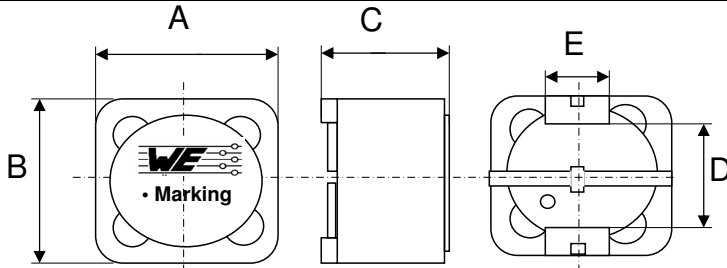

● = Start of winding Marking = Inductance code

	Typ L	
A	12,0 ± 0,3	mm
B	12,0 ± 0,3	mm
C	6,0 max.	mm
D	8,0 ± 0,3	mm
E	5,0 ± 0,2	mm

B Elektrische Eigenschaften / Electrical properties :

Eigenschaften / properties	Testbedingungen / test conditions		Wert / value	Einheit / unit	tol.
Induktivität / Inductance	1 kHz / 0,25V	L	8,20	μH	±20%
DC-Widerstand / DC-resistance	@ 20°C	R _{DC typ.}	0,014	Ω	typ.
DC-Widerstand / DC-resistance	@ 20°C	R _{DC max.}	0,020	Ω	max.
Nennstrom / Rated current	ΔT=40 K	I _{DC}	6,25	A	max.
Sättigungsstrom / Saturation current	ΔL/L <10%	I _{sat}	6,25	A	typ.
Eigenres.-Frequenz / Self-res.-frequency		SRF	25,00	MHz	min.

C Lötpad / Soldering spec. :

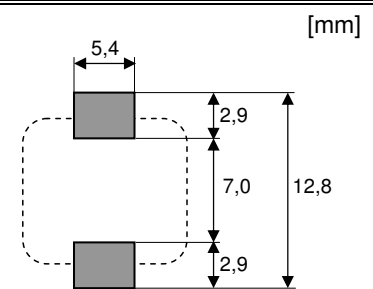

D Prüfgeräte / test equipment :

HP 4274 A für/for L und/and Q
 HP 34401 A für/for I_{DC} und/and R_{DC}

E Testbedingungen / test conditions :

Luftfeuchtigkeit / humidity: 33%
 Umgebungstemperatur / temperature: +20°C

F Werkstoffe & Zulassungen / material & approvals :

Basismaterial / base material: Ferrit/ferrite
 Endoberfläche / finishing electrode: 100% Sn
 Anbindung an Elektrode / soldering wire to plating: Sn/Ag/Cu - 96.5/3.0/0.5%
 Draht / wire: 2SFBW 155°C

G Eigenschaften / general specifications :

Betriebstemp. / operating temperature: -40°C - + 125°C
 Umgebungstemp. / ambient temperature: -40°C - + 85°C
 It is recommended that the temperature of the part does not exceed 125°C under worst case operating conditions.

Freigabe erteilt / general release:	Kunde / customer		
.....	Unterschrift / signature		
Datum / date	Würth Elektronik		
	PT	Version 7	06-09-07
	MST	Version 1	05-01-12
.....	Name	Änderung / modification	Datum / date
Geprüft / checked	Kontrolliert / approved		

Würth Elektronik eiSos GmbH & Co. KG

D-74638 Waldenburg · Max-Eyth-Strasse 1 - 3 · Germany · Telefon (+49) (0) 7942 - 945 - 0 · Telefax (+49) (0) 7942 - 945 - 400
<http://www.we-online.com>

Spezifikation für Freigabe / specification for release

Kunde / customer : _____
 Artikelnummer / part number : **744771008**

LF



Bezeichnung : **SPEICHERDROSSEL WE-PD**
 description : **POWER-CHOKE WE-PD**

WÜRTH ELEKTRONIK

DATUM / DATE : 2005-01-12

H Induktivitätskurve / Inductance curve :

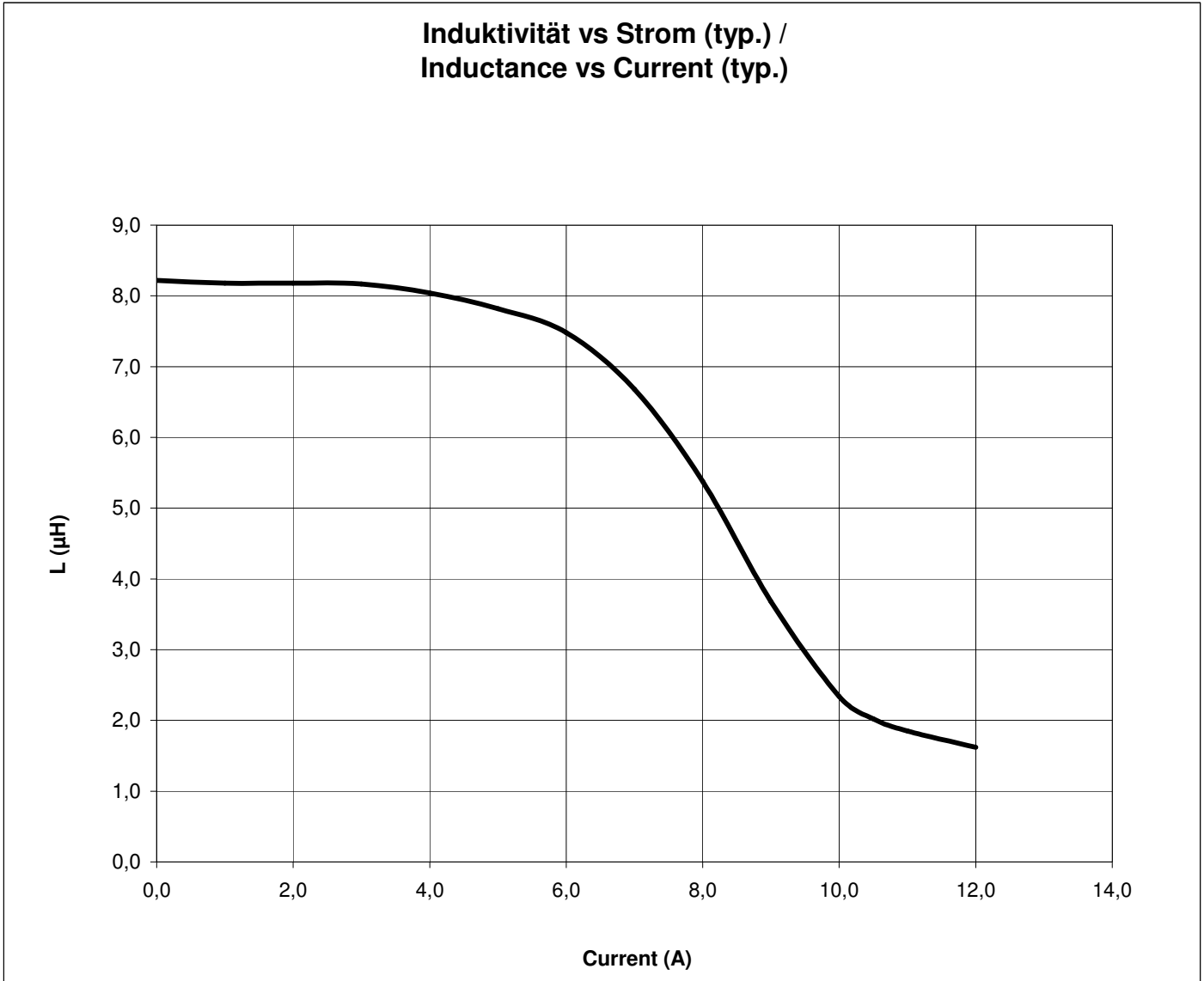

Freigabe erteilt / general release:	Kunde / customer			
Datum / date	Unterschrift / signature			
	Würth Elektronik			
Geprüft / checked	Kontrolliert / approved	PT	Version 7	06-09-07
		MST	Version 1	05-01-12
		Name	Änderung / modification	Datum / date

Würth Elektronik eiSos GmbH & Co. KG

D-74638 Waldenburg · Max-Eyth-Strasse 1 - 3 · Germany · Telefon (+49) (0) 7942 - 945 - 0 · Telefax (+49) (0) 7942 - 945 - 400
<http://www.we-online.com>

Spezifikation für Freigabe / specification for release

Kunde / customer : _____
 Artikelnummer / part number : **744771008**

LF



Bezeichnung : **SPEICHERDROSSEL WE-PD**
 description : **POWER-CHOKE WE-PD**

WÜRTH ELEKTRONIK

DATUM / DATE : 2005-01-12

I Rollenspezifikation / tape and reel specification :

Gurtspezifikation / Tape specification:

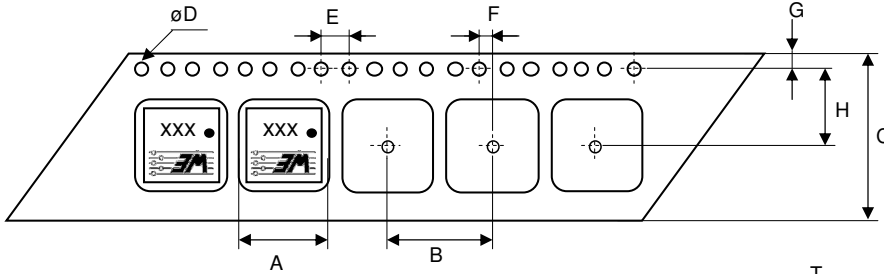

A	12,7 ± 0,1	mm
B	16,0 ± 0,1	mm
C	24,0 ± 0,2	mm
D	1,50 ± 0,1 - 0,0	mm
E	4,00 ± 0,1	mm
F	2,00 ± 0,1	mm
G	1,75 ± 0,1	mm
H	11,5 ± 0,1	mm
I	12,7 ± 0,1	mm
J	6,20 ± 0,1	mm
T	0,40 ± 0,05	mm

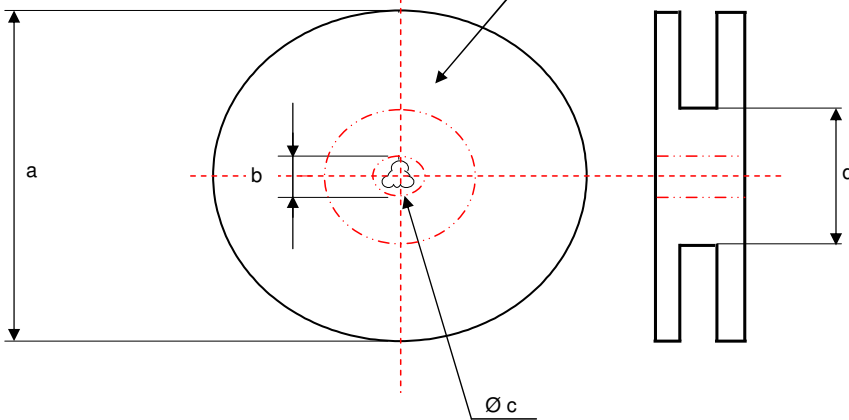
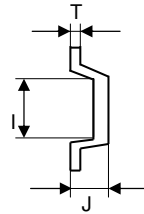

Rollenspezifikation / Reel specification:

a	330,0 ± 0,5	mm
b	20,20 ± 0,2	mm
c	13,00 ± 0,5 - 1,0	mm
d	100,0 ± 0,2	mm

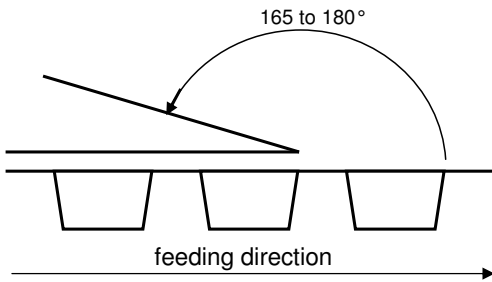

The force for tearing off cover tape is 10 to 130 grams in arrow direction

Freigabe erteilt / general release:	Kunde / customer		
Datum / date	Unterschrift / signature		
	Würth Elektronik		
Geprüft / checked	Kontrolliert / approved		
	PT	Version 7	06-09-07
	MST	Version 1	05-01-12
	Name	Änderung / modification	Datum / date

This electronic component has been designed and developed for usage in general electronic equipment. Before incorporating this component into any equipment where higher safety and reliability is especially required or if there is the possibility of direct damage or injury to human body, for example in the range of aerospace, aviation, nuclear control, submarine, transportation, (automotive control, train control, ship control), transportation signal, disaster prevention, medical, public information network etc, Würth Elektronik eiSos GmbH must be informed before the design-in stage. In addition, sufficient reliability evaluation checks for safety must be performed on every electronic component which is used in electrical circuits that require high safety and reliability functions or performance.

Würth Elektronik eiSos GmbH & Co. KG

D-74638 Waldenburg · Max-Eyth-Strasse 1 - 3 · Germany · Telefon (+49) (0) 7942 - 945 - 0 · Telefax (+49) (0) 7942 - 945 - 400
<http://www.we-online.com>