

FAN102

Primary-Side-Control PWM Controller

Features

- Constant-Voltage (CV) and Constant-Current (CC) Control without Secondary-Feedback Circuitry
- Green Mode: Frequency Reduction at Light Load
- Fixed PWM Frequency at 42kHz with Frequency Hopping to Reduce EMI
- Cable Voltage Drop Compensation in CV Mode
- Low Startup Current: 10µA
- Low Operating Current: 3.5mA
- Peak-Current-Mode Control in CV Mode
- Cycle-by-Cycle Current Limiting
- V_{DD} Over-Voltage Protection with Auto-Restart
- V_{DD} Under-Voltage Lockout (UVLO)
- Gate Output Maximum Voltage Clamped at 18V
- Fixed Over-Temperature Protection with Auto-Restart
- SOP-8 Package Available

Applications

- Battery Chargers for Cellular Phones, Cordless Phones, PDA, Digital Cameras, Power Tools
- Replaces Linear Transformer and RCC SMPS
- Offline High Brightness (HB) LED Drivers

Description

The primary-side PWM controller significantly simplifies power supply design that requires CV and CC regulation capabilities. The FAN102 controls the output voltage and current precisely with the information in the primary side of the power supply, not only removing the output current sensing loss, but eliminating all secondary feedback circuitry.

The green-mode function with a low startup current (10µA) maximizes the light-load efficiency so the power supply can meet stringent standby power regulations.

Compared with a conventional secondary-side regulation approach, the FAN102 can reduce total cost, component count, size, and weight; while simultaneously increasing efficiency, productivity, and system reliability.

A typical output CV/CC characteristic envelope is shown in Figure 1.

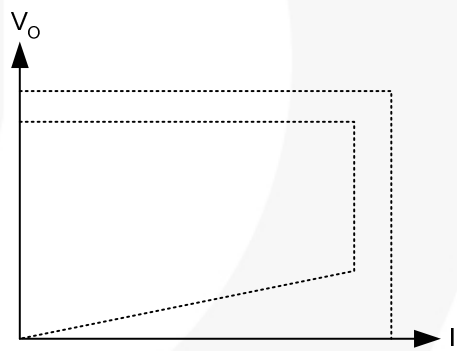

Figure 1. Typical Output V-I Characteristic

Ordering Information

| Part Number | Operating Temperature Range | Eco Status | Package | Packing Method |
|-------------|-----------------------------|------------|---------------------------------------|----------------|
| FAN102MY | -40°C to +105°C | Green | 8-Lead, Small Outline Package (SOP-8) | Tape & Reel |

For Fairchild's definition of Eco Status, please visit: http://www.fairchildsemi.com/company/green/rohs_green.html.

Marking Information

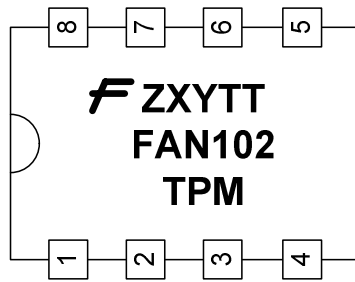

F- Fairchild Logo
 Z- Plant Code
 X- 1-Digit Year Code
 Y- 1-Digit Week Code
 TT- 2-Digit Die Run Code
 T- Package Type (M=SOP)
 P- Z: Pb Free, Y: Green Package
 M- Manufacture Flow Code

Figure 4. Top Mark

Pin Configuration

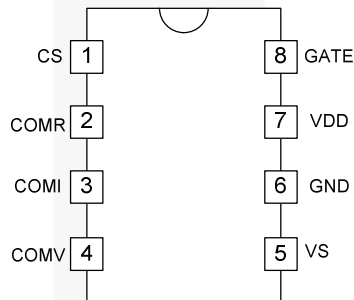

Figure 5. Pin Configuration

Pin Definitions

| Pin # | Name | Description |
|-------|------|---|
| 1 | CS | Current Sense. This pin connects a current-sense resistor to sense the MOSFET current for peak-current-mode control in CV mode and provides for output-current regulation in CC mode. |
| 2 | COMR | Cable Compensation. This pin is connects a capacitor between COMR and GND for compensation voltage drop due to output cable loss in CV mode. |
| 3 | COMI | Constant Current Loop Compensation. This pin is connects a capacitor and a resistor between COMI and GND for compensation current loop gain. |
| 4 | COMV | Constant Voltage Loop Compensation. This pin is connects a capacitor and a resistor between COMV and GND for compensation voltage loop gain. |
| 5 | VS | Voltage Sense. This pin detects the output voltage information and discharges time base on voltage of auxiliary winding. This pin connects two divider resistors and one capacitor. |
| 6 | GND | Ground. |
| 7 | VDD | Power Supply. IC operating current and MOSFET driving current are supplied using this pin. This pin is connected to an external V_{DD} capacitor (typically $10\mu\text{F}$). The threshold voltages for startup and turn-off are 16V and 5V, respectively. |
| 8 | GATE | PWM Signal Output. This pin outputs PWM signal and includes the internal totem-pole output driver to drive the external power MOSFET. The clamped gate output voltage is 18V. |

Absolute Maximum Ratings

Stresses exceeding the absolute maximum ratings may damage the device. The device may not function or be operable above the recommended operating conditions and stressing the parts to these levels is not recommended. In addition, extended exposure to stresses above the recommended operating conditions may affect device reliability. The absolute maximum ratings are stress ratings only.

| Symbol | Parameter | Min. | Max. | Unit |
|-------------------|---|------|------|------|
| V _{DD} | DC Supply Voltage ^(1,2) | | 30 | V |
| V _{VS} | VS Pin Input Voltage | -0.3 | 7.0 | V |
| V _{CS} | CS Pin Input Voltage | -0.3 | 7.0 | V |
| V _{COMV} | Voltage Error Amplifier Output Voltage | -0.3 | 7.0 | V |
| V _{COMI} | Voltage Error Amplifier Output Voltage | -0.3 | 7.0 | V |
| P _D | Power Dissipation (T _A < 50°C) | | 660 | mW |
| θ _{JA} | Thermal Resistance (Junction-to-Air) | | 150 | °C/W |
| θ _{JC} | Thermal Resistance (Junction-to-Case) | | 39 | °C/W |
| T _J | Operating Junction Temperature | | +150 | °C |
| T _{STG} | Storage Temperature Range | -55 | +150 | °C |
| T _L | Lead Temperature (Wave Soldering or IR, 10 Seconds) | | +260 | °C |
| ESD | Electrostatic Discharge Capability, Human Body Model, JEDEC- JESD22_A114 | | 4.5 | kV |
| | Electrostatic Discharge Capability, Charged Device Model, JEDEC- JESD22_C101 | | 1250 | V |

Notes:

1. Stresses beyond those listed under "absolute maximum ratings" may cause permanent damage to the device.
2. All voltage values, except differential voltages, are given with respect to GND pin.

Recommended Operating Conditions

The Recommended Operating Conditions table defines the conditions for actual device operation. Recommended operating conditions are specified to ensure optimal performance to the datasheet specifications. Fairchild does not recommend exceeding them or designing to Absolute Maximum Ratings.

| Symbol | Parameter | Conditions | Min. | Typ. | Max. | Unit |
|----------------|-------------------------------|------------|------|------|------|------|
| T _A | Operating Ambient Temperature | | -40 | | +105 | °C |

Electrical Characteristics

$V_{DD}=15V$ and $T_A=25^{\circ}C$ unless otherwise specified.

| Symbol | Parameter | Conditions | Min. | Typ. | Max. | Units | |
|-------------------------------|--|--|-------------------|-----------|-----------|-----------|-----|
| V_{DD} Section | | | | | | | |
| V_{OP} | Continuously Operating Voltage | | | | 25 | V | |
| V_{DD-ON} | Turn-On Threshold Voltage | | 15 | 16 | 17 | V | |
| V_{DD-OFF} | Turn-Off Threshold Voltage | | 4.5 | 5.0 | 5.5 | V | |
| I_{DD-OP} | Operating Current | $V_{DD}=20V$, $f_s=f_{OSC}$, $V_{VS}=2V$, $V_{CS}=3V$, $C_L=1nF$ | | 3.5 | 5.0 | mA | |
| I_{DD-ST} | Startup Current | $0 < V_{DD} < V_{DD-ON}-0.16V$ | 0 | 1.6 | 10.0 | μA | |
| $I_{DD-GREEN}$ | Green-Mode Operating Supply Current | $V_{DD}=20V$, $V_{VS}=2.7V$ $f_s=f_{OSC-N-MIN}$, $V_{CS}=0V$ $C_L=1nF$, $V_{COMV}=0V$ | | 1 | 2 | mA | |
| V_{DD-OVP} | V_{DD} Over-Voltage Protection Level | $V_{CS}=3V$, $V_{VS}=2.3V$ | 27 | 28 | 29 | V | |
| $t_{D-VDDOVP}$ | V_{DD} Over-Voltage Protection Debounce Time | $f_s=f_{OSC}$, $V_{VS}=2.3V$ | 100 | 250 | 400 | μs | |
| Oscillator Section | | | | | | | |
| f_{OSC} | Frequency | Center Frequency | $T_A=25^{\circ}C$ | 39 | 42 | 45 | KHz |
| | | Frequency Hopping Range | $T_A=25^{\circ}C$ | ± 1.8 | ± 2.6 | ± 3.6 | |
| t_{FHR} | Frequency Hopping Period | $T_A=25^{\circ}C$ | | 3 | | ms | |
| $f_{OSC-N-MIN}$ | Minimum Frequency at No Load | $V_{VS}=2.7V$, $V_{COMV}=0V$ | | 550 | | Hz | |
| $f_{OSC-CM-MIN}$ | Minimum Frequency at CCM | $V_{VS}=2.3V$, $V_{CS}=0.5V$ | | 20 | | KHz | |
| f_{DV} | Frequency Variation vs. V_{DD} Deviation | $V_{DD}=10V$ to $25V$ | | | 5 | % | |
| f_{DT} | Frequency Variation vs. Temperature Deviation | $T_A=-40^{\circ}C$ to $+105^{\circ}C$ | | | 15 | % | |
| Voltage-Sense Section | | | | | | | |
| I_{VS-UVP} | Sink Current for Brownout Protection | $R_{VS}=20K\Omega$ | | 180 | | μA | |
| I_{tc} | IC Compensation Bias Current | | | 9.5 | | μA | |
| $V_{BIAS-COMV}$ | Adaptive Bias Voltage Dominated by V_{COMV} | $V_{COMV}=0V$, $T_A=25^{\circ}C$, $R_{VS}=20K\Omega$ | | 1.4 | | V | |
| Current-Sense Section | | | | | | | |
| t_{PD} | Propagation Delay to GATE Output | | | 100 | 200 | ns | |
| t_{MIN-N} | Minimum On Time at No Load | $V_{VS}=-0.8V$, $R_S=2K\Omega$, $V_{COMV}=1V$ | | 1100 | | ns | |
| t_{MINCC} | Minimum On Time in CC Mode | $V_{VS}=0V$, $V_{COMV}=2V$ | | 400 | | ns | |
| V_{TH} | Threshold Voltage for Current Limit | | | 1.3 | | V | |

Continued on the following page...

Electrical Characteristics

$V_{DD}=15V$ and $T_A=25^{\circ}C$ unless otherwise specified.

| Symbol | Parameter | Conditions | Min. | Typ. | Max. | Units |
|--|---|---------------------------------------|-------|-------|-------|-------------|
| Voltage-Error-Amplifier Section | | | | | | |
| V_{VR} | Reference Voltage | | 2.475 | 2.500 | 2.525 | V |
| V_N | Green Mode Starting Voltage on COMV Pin | $f_s=f_{OSC}=2KHz$, $V_{VS}=2.3V$ | | 2.8 | | V |
| V_G | Green Mode Ending Voltage on COMV Pin | $f_s=1KHz$ | | 0.8 | | V |
| I_{V-SINK} | Output Sink Current | $V_{VS}=3V$, $V_{COMV}=2.5V$ | | 90 | | μA |
| $I_{V-SOURCE}$ | Output Source Current | $V_{VS}=2V$, $V_{COMV}=2.5V$ | | 90 | | μA |
| V_{V-HGH} | Output High Voltage | $V_{VS}=2.3V$ | 4.5 | | | V |
| Current-Error-Amplifier Section | | | | | | |
| V_{IR} | Reference Voltage | | 2.475 | 2.500 | 2.525 | V |
| I_{I-SINK} | Output Sink Current | $V_{CS}=3V$, $V_{COMI}=2.5V$ | | 55 | | μA |
| $I_{I-SOURCE}$ | Output Source Current | $V_{CS}=0V$, $V_{COMI}=2.5V$ | | 55 | | μA |
| V_{I-HGH} | Output High Voltage | $V_{CS}=0V$ | 4.5 | | | V |
| Cable Compensation Section | | | | | | |
| V_{COMR} | Variation Test Voltage on COMR Pin for Cable Compensation | $R_{COMR}=100K\Omega$ | | 0.735 | | V |
| Gate Section | | | | | | |
| DCY_{MAX} | Maximum Duty Cycle | | | 75 | | % |
| V_{OL} | Output Voltage LOW | $V_{DD}=20V$, $I_O=10mA$ | | | 1.5 | V |
| V_{OH} | Output Voltage HIGH | $V_{DD}=8V$, $I_O=1mA$ | 5 | | | V |
| V_{OH_MIN} | Output Voltage HIGH | $V_{DD}=5.5V$, $I_O=1mA$ | 4 | | | V |
| t_r | Rising Time | $V_{DD}=20V$, $C_L=1nF$ | | 200 | 300 | ns |
| t_f | Falling Time | $V_{DD}=20V$, $C_L=1nF$ | | 80 | 150 | ns |
| V_{CLAMP} | Output Clamp Voltage | $V_{DD}=25V$ | | 15 | 18 | V |
| Over-Temperature-Protection Section | | | | | | |
| T_{OTP} | Threshold Temperature for OTP ⁽³⁾ | | | +140 | | $^{\circ}C$ |

Note:

- When over-temperature protection is activated, the power system enters auto restart mode and output is disabled.

Typical Performance Characteristics

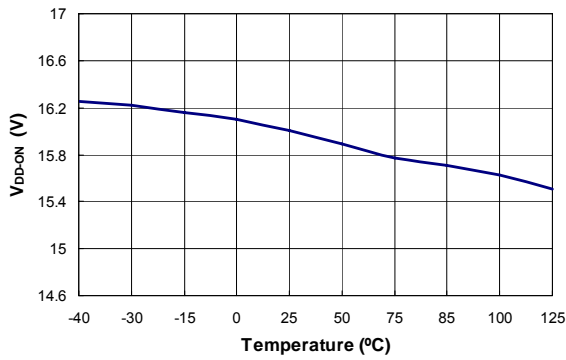

Figure 6. Turn-On Threshold Voltage (V_{DD-ON}) vs. Temperature

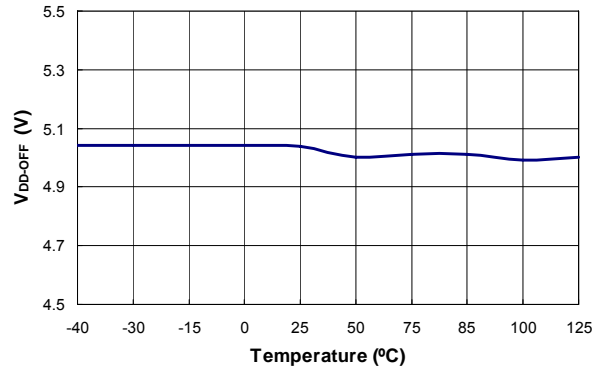

Figure 7. Turn-Off Threshold Voltage (V_{DD-OFF}) vs. Temperature

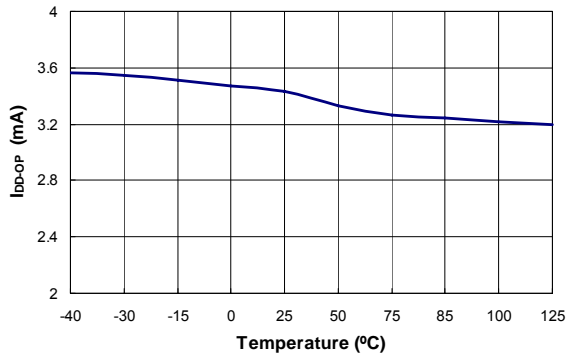

Figure 8. Operating Current (I_{DD-OP}) vs. Temperature

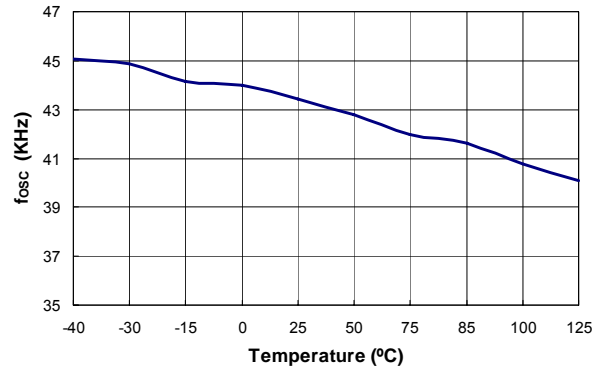

Figure 9. Center Frequency (f_{osc}) vs. Temperature

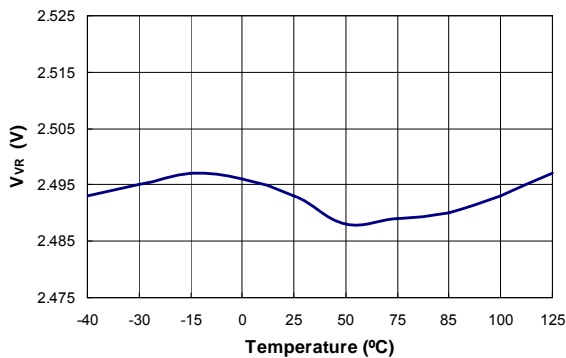

Figure 10. Reference Voltage (V_{VR}) vs. Temperature

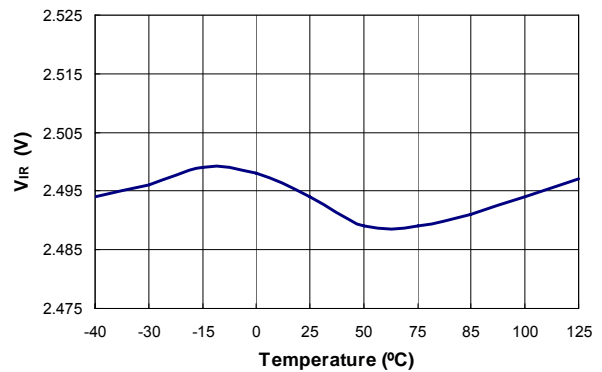

Figure 11. Reference Voltage (V_{IR}) vs. Temperature

Typical Performance Characteristics

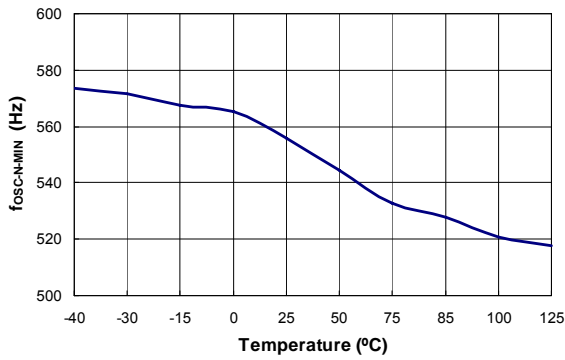

Figure 12. Minimum Frequency at No Load (f_{OSC-N-MIN}) vs. Temperature

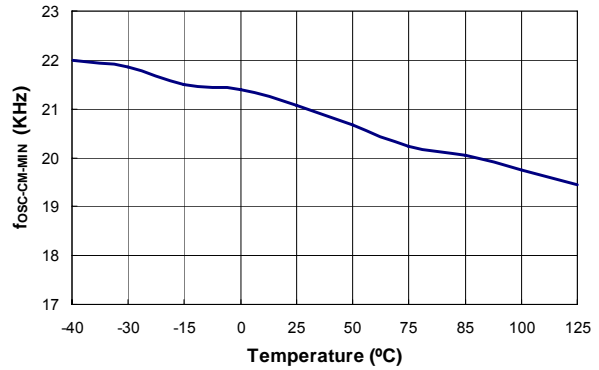

Figure 13. Minimum Frequency at CCM (f_{OSC-CM-MIN}) vs. Temperature

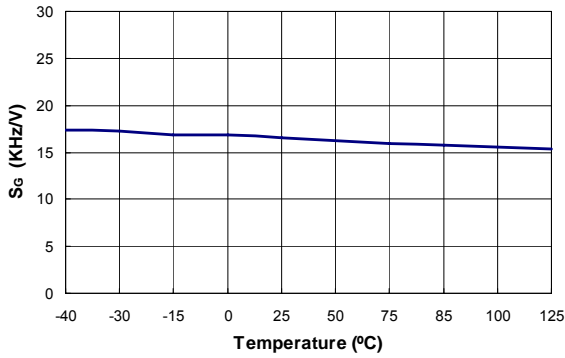

Figure 14. Green Mode Frequency Decreasing Rate (S_G) vs. Temperature

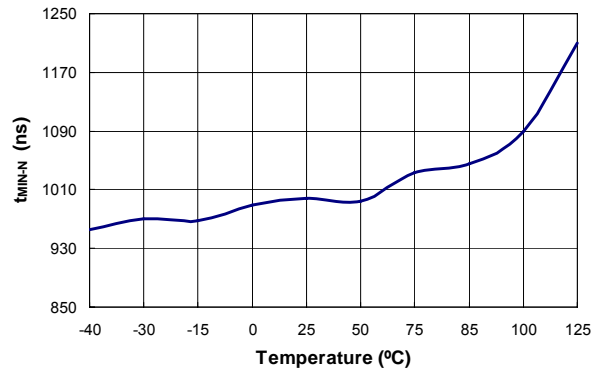

Figure 15. Minimum On Time at No Load (t_{MIN-N}) vs. Temperature

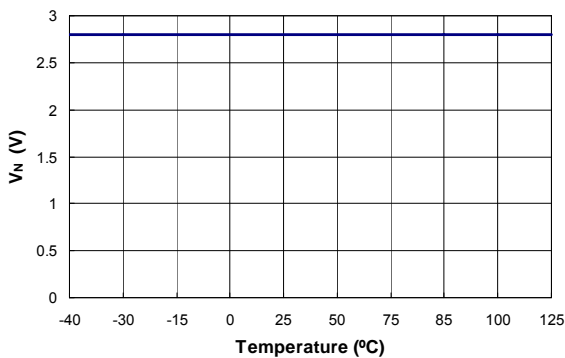

Figure 16. Green Mode Starting Voltage on COMV Pin (V_N) vs. Temperature

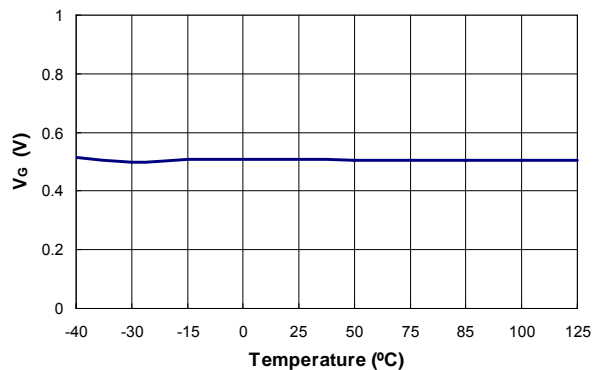

Figure 17. Green Mode Ending Voltage on COMV Pin (V_G) vs. Temperature

Typical Performance Characteristics

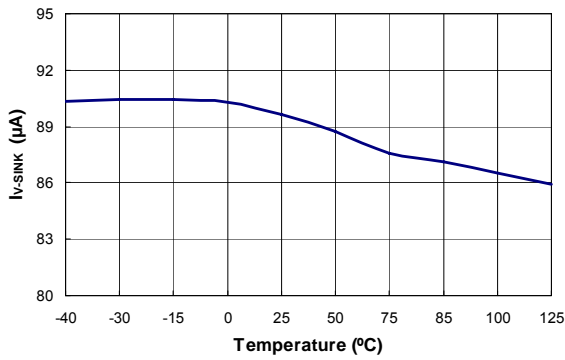

Figure 18. Output Sink Current (I_{v-SINK}) vs. Temperature

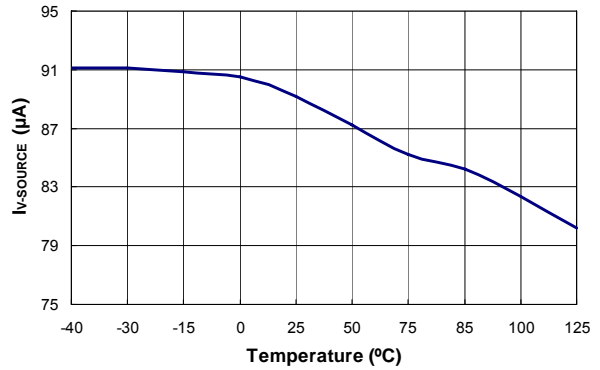

Figure 19. Output Source Current ($I_{v-SOURCE}$) vs. Temperature

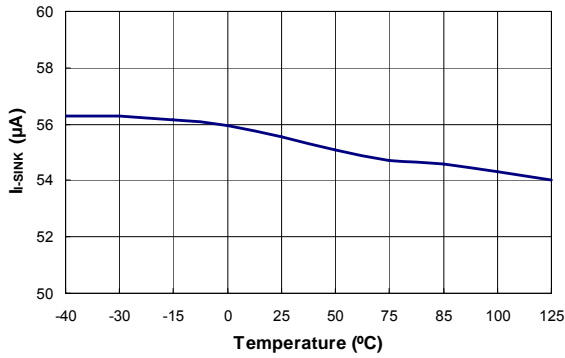

Figure 20. Output Sink Current (I_{i-SINK}) vs. Temperature

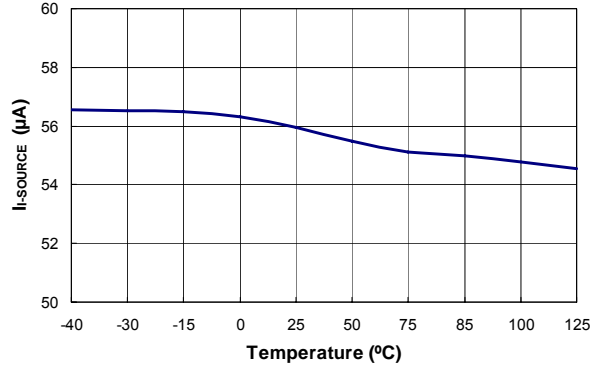

Figure 21. Output Source Current ($I_{i-SOURCE}$) vs. Temperature

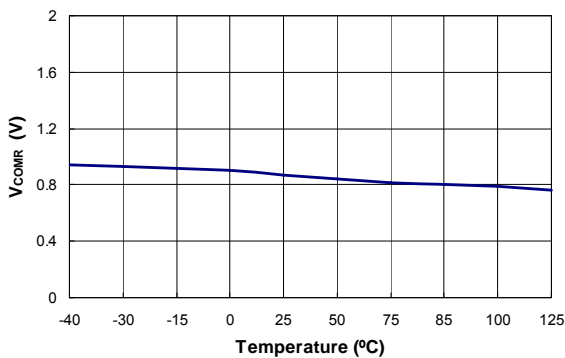

Figure 22. Variation Test Voltage on COMR Pin for Cable Compensation (V_{COMR}) vs. Temperature

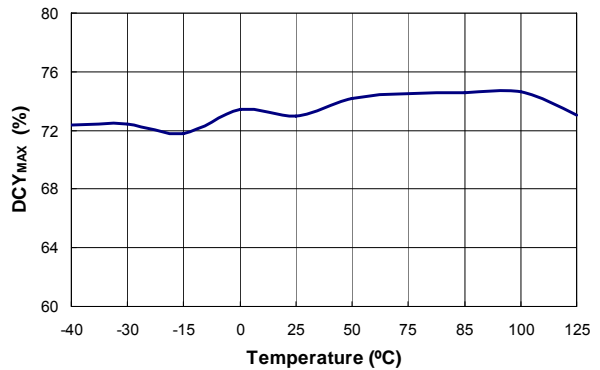

Figure 23. Maximum Duty Cycle (DCY_{MAX}) vs. Temperature

Functional Description

Figure 24 shows the basic circuit diagram of primary-side regulated flyback converter with typical waveforms shown in Figure 25. Generally, discontinuous conduction mode (DCM) operation is preferred for primary-side regulation since it allows better output regulation. The operation principles of DCM flyback converter are as follows:

During the MOSFET ON time (t_{ON}), input voltage (V_{DL}) is applied across the primary-side inductor (L_m). Then MOSFET current (I_{ds}) increases linearly from zero to the peak value (I_{pk}). During this time, the energy is drawn from the input and stored in the inductor.

When the MOSFET is turned off, the energy stored in the inductor forces the rectifier diode (D) to turn on. While the diode is conducting, the output voltage (V_o), together with diode forward voltage drop (V_F), are applied across the secondary-side inductor ($L_m \times N_s^2 / N_p^2$) and the diode current (I_D) decreases linearly from the peak value ($I_{pk} \times N_p / N_s$) to zero. At the end of inductor current discharge time (t_{DIS}), all the energy stored in the inductor has been delivered to the output.

When the diode current reaches zero, the transformer auxiliary winding voltage (V_w) begins to oscillate by the resonance between the primary-side inductor (L_m) and the effective capacitor loaded across MOSFET.

During the inductor current discharge time, the sum of output voltage and diode forward voltage drop is reflected to the auxiliary winding side as $(V_o + V_F) \times N_A / N_s$. Since the diode forward voltage drop decreases as current decreases, the auxiliary winding voltage reflects the output voltage best at the end of diode conduction time where the diode current diminishes to zero. By sampling the winding voltage at the end of the diode conduction time, the output voltage information can be obtained. The internal error amplifier for output voltage regulation (EA_V) compares the sampled voltage with internal precise reference to generate error voltage (V_{COMV}), which determines the duty cycle of the MOSFET in CV mode.

Meanwhile, the output current can be estimated using the peak drain current and inductor current discharge time since output current is same as average of the diode current in steady state.

The output current estimator picks up the peak value of the drain current with a peak detection circuit and calculates the output current using the inductor discharge time (t_{DIS}) and switching period (t_s). The output information is compared with internal precise reference to generate error voltage (V_{COMI}), which determines the duty cycle of the MOSFET in CC mode.

Among the two error voltages, V_{COMV} and V_{COMI} , the smaller actually determines the duty cycle. During constant voltage regulation mode, V_{COMV} determines the duty cycle while V_{COMI} is saturated to high. During constant current regulation mode, V_{COMI} determines the duty cycle while V_{COMV} is saturated to HIGH.

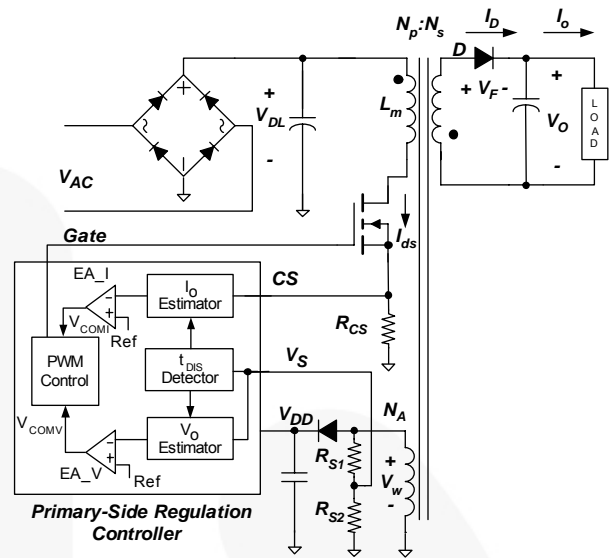

Figure 24. Simplified PSR Flyback Converter Circuit

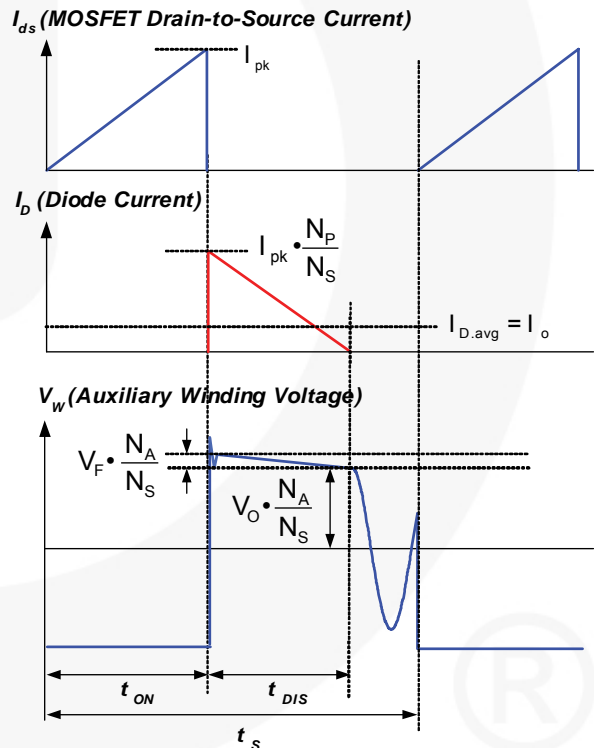

Figure 25. Key Waveforms of DCM Flyback Converter

Cable Voltage Drop Compensation

When it comes to cellular phone charger applications, the actual battery is located at the end of cable, which causes typically several percent of voltage drop on the actual battery voltage. FAN102 has a programmable cable voltage drop compensation, which provides a constant output voltage at the end of the cable over the entire load range in CV mode. As load increases, the voltage drop across the cable is compensated by increasing the reference voltage of voltage regulation error amplifier. The amount of compensation is programmed by the resistor on the COMR pin. The relationship between the amount of compensation and COMR resistor is shown in Figure 26.

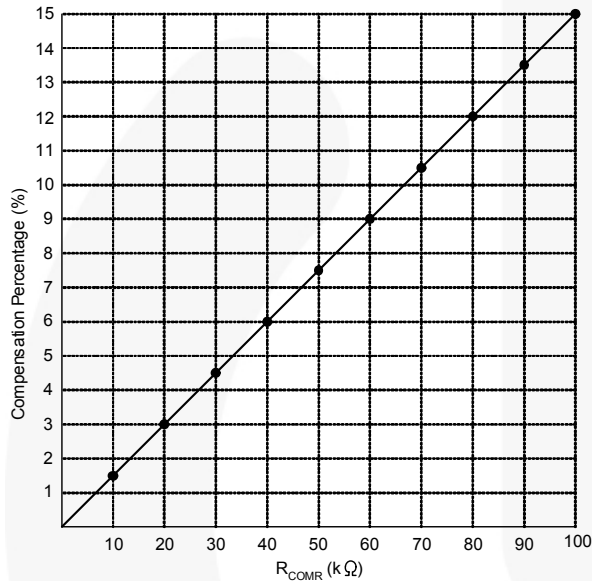

Figure 26. Cable Voltage Drop Compensation

Temperature Compensation

Built-in temperature compensation provides constant voltage regulation over a wide range of temperature variation. This internal compensation current compensates the forward-voltage drop variation of the secondary-side rectifier diode.

Green-Mode Operation

The FAN102 uses voltage regulation error amplifier output (V_{COMV}) as an indicator of the output load and modulates the PWM frequency, as shown in Figure 27, such that the switching frequency decreases as load decreases. In heavy load conditions, the switching frequency is fixed at 42KHz. Once V_{COMV} decreases below 2.8V, the PWM frequency starts to linearly decrease from 42KHz to 550Hz to reduce the switching losses. As V_{COMV} decreases below 0.8V, the switching frequency is fixed at 550Hz and FAN102 enters deep green mode, where the operating current reduces to 1mA, further reducing the standby power consumption.

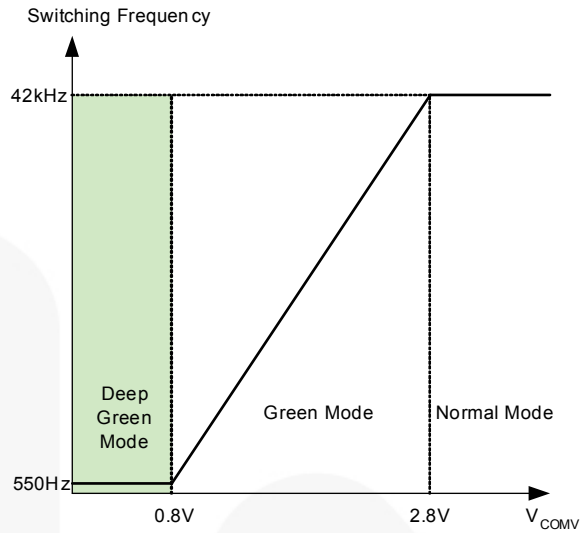

Figure 27. Switching Frequency in Green Mode

Frequency Hopping

EMI reduction is accomplished by frequency hopping, which spreads the energy over a wider frequency range than the bandwidth measured by the EMI test equipment. FAN102 has an internal frequency hopping circuit that changes the switching frequency between 39.4kHz and 44.6kHz with a period of 3ms, as shown in Figure 28.

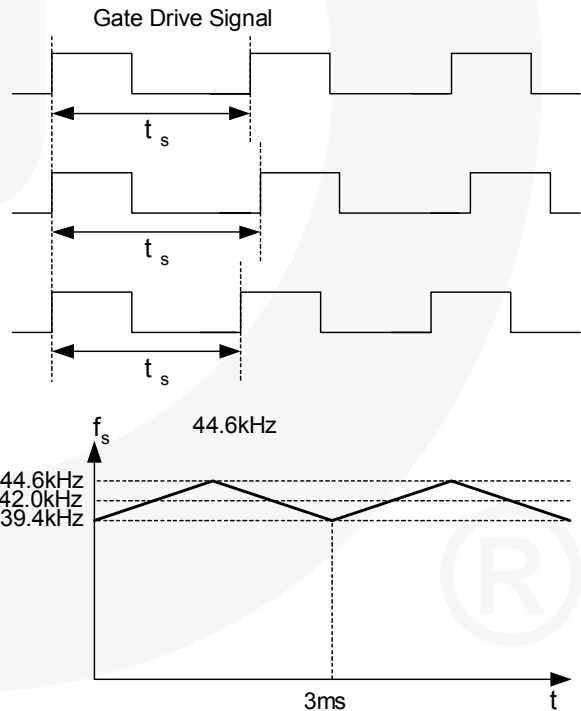

Figure 28. Frequency Hopping

Leading-Edge Blanking (LEB)

At the instant the MOSFET is turned on, a high-current spike occurs through the MOSFET, caused by primary-side capacitance and secondary-side rectifier reverse recovery. Excessive voltage across the R_{CS} resistor can lead to premature turn-off of MOSFET. FAN102 employs an internal leading-edge blanking (LEB) circuit. To inhibit the PWM comparator for a short time after the MOSFET is turned on. Thus, external RC filtering is not required.

Startup

Figure 29 shows the typical startup circuit and transformer auxiliary winding for a FAN102 application. Before FAN102 begins switching, it consumes only startup current (typically $10\mu\text{A}$) and the current supplied through the startup resistor charges the V_{DD} capacitor (C_{DD}). When V_{DD} reaches turn-on voltage of 16V (V_{DD-ON}), FAN102 begins switching and the current consumed by FAN102 increases to 3.5mA. Then, the power required for FAN102 is supplied from the transformer auxiliary winding. The large hysteresis of V_{DD} provides more holdup time, which allows using a small capacitor for V_{DD} .

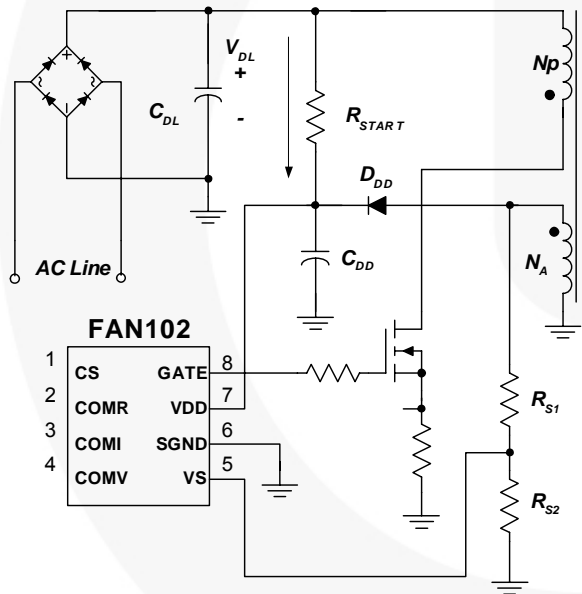

Figure 29. Startup Circuit

Protections

The FAN102 has several self-protective functions, such as Over-Voltage Protection (OVP), Over-Temperature Protection (OTP) and brownout protection. All the protections are implemented as auto-restart mode. Once the fault condition occurs, switching is terminated and the MOSFET remains off. This causes V_{DD} to fall. When V_{DD} reaches the V_{DD} turn-off voltage of 5V, the current consumed by FAN102 reduces to the startup current (typically $10\mu\text{A}$) and the current supplied startup resistor charges the V_{DD} capacitor. When V_{DD} reaches the turn-on voltage of 16V, FAN102 resumes normal

operation. In this manner, the auto-restart alternately enables and disables the switching of the MOSFET until the fault condition is eliminated (see Figure 30).

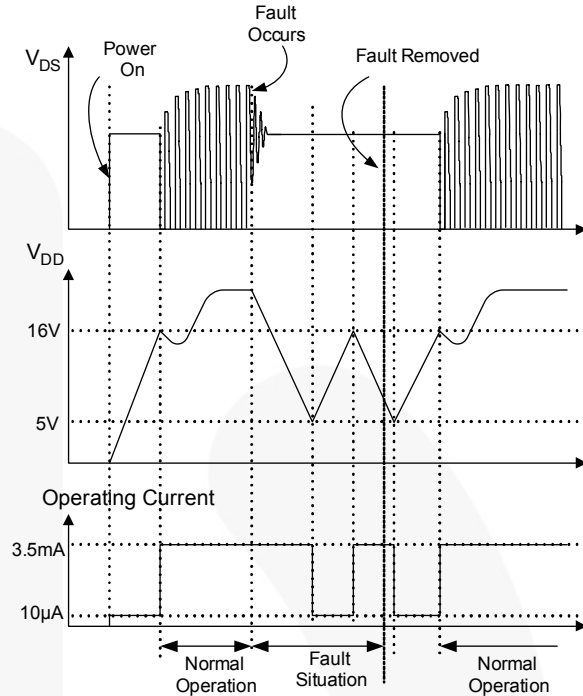

Figure 30. Auto-Restart Operation

V_{DD} Over-Voltage Protection (OVP)

V_{DD} over-voltage protection prevents damage from over-voltage conditions. If the V_{DD} voltage exceeds 28V by open feedback condition, OVP is triggered. The OVP has a de-bounce time (typical $250\mu\text{s}$) to prevent false trigger by switching noise. It also protects other switching devices from over voltage.

Over-Temperature Protection (OTP)

A built-in temperature-sensing circuit shuts down PWM output if the junction temperature exceeds 140°C .

Brownout Protection

FAN102 detects the line voltage using auxiliary winding voltage since the auxiliary winding voltage reflects the input voltage when the MOSFET is turned on. The VS pin is clamped at 1.15V while the MOSFET is turned on and brownout protection is triggered if the current out of the VS pin is less than I_{VS-UVP} (typical $180\mu\text{A}$) during the MOSFET conduction.

Pulse-by-Pulse Current Limit

When the sensing voltage across the current sense resistor exceeds the internal threshold of 1.4V, the MOSFET is turned off for the remainder of switching cycle. In normal operation, the pulse-by-pulse current limit is not triggered since the peak current is limited by the control loop.

Typical Application Circuit (Primary-Side Regulated Flyback Charger)

| Application | Fairchild Devices | Input Voltage Range | Output |
|--------------------|-------------------|-----------------------|-----------------|
| Cell Phone Charger | FAN102 | 90~265V _{AC} | 5V/0.78A (3.9W) |

Features

- High efficiency (>68% at full load) meeting Energy StarSM V2.0 and CEC regulation with enough margin
- Low standby power consumption (Pin=0.087W for 115V_{AC} and Pin=0.123W for 230V)
- Tight output regulation (CV:±5%, CC:±7%)

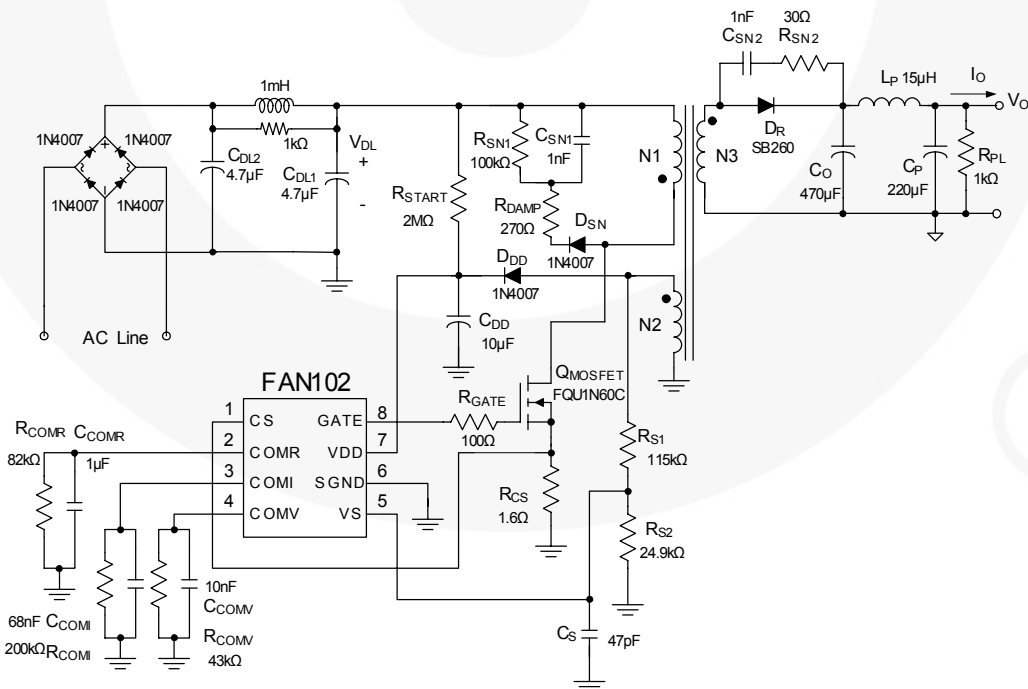
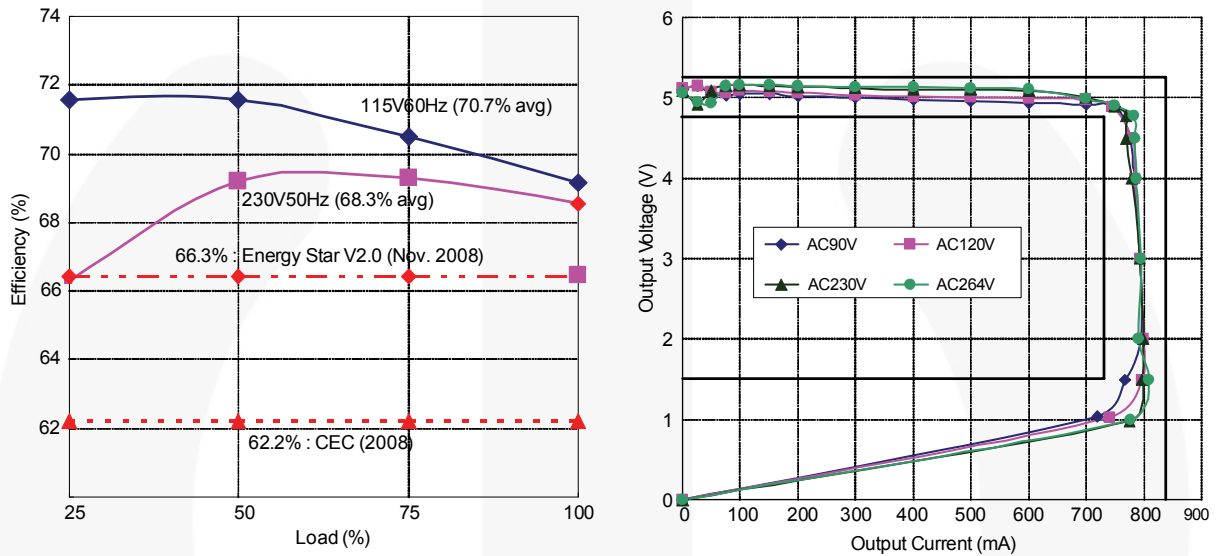

Typical Application Circuit (Continued)

Transformer specification

- Core: EE16
- Bobbin: EE16

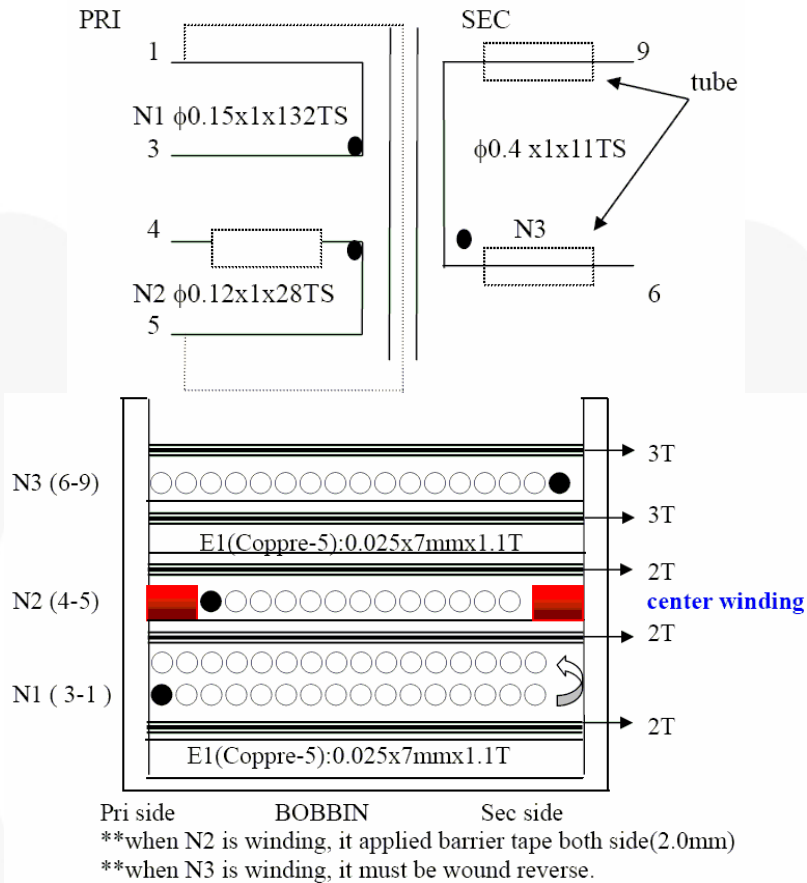

| | Pin | Specification | Remark |
|--------------------------------|-----|----------------------|-------------------------------------|
| Primary-Side Inductance | 1-3 | 2.3mH \pm 5% | 100kHz, 1V |
| Primary-Side Effective Leakage | 1-8 | 65 μ H \pm 5%. | Short one of the secondary windings |

Physical Dimensions

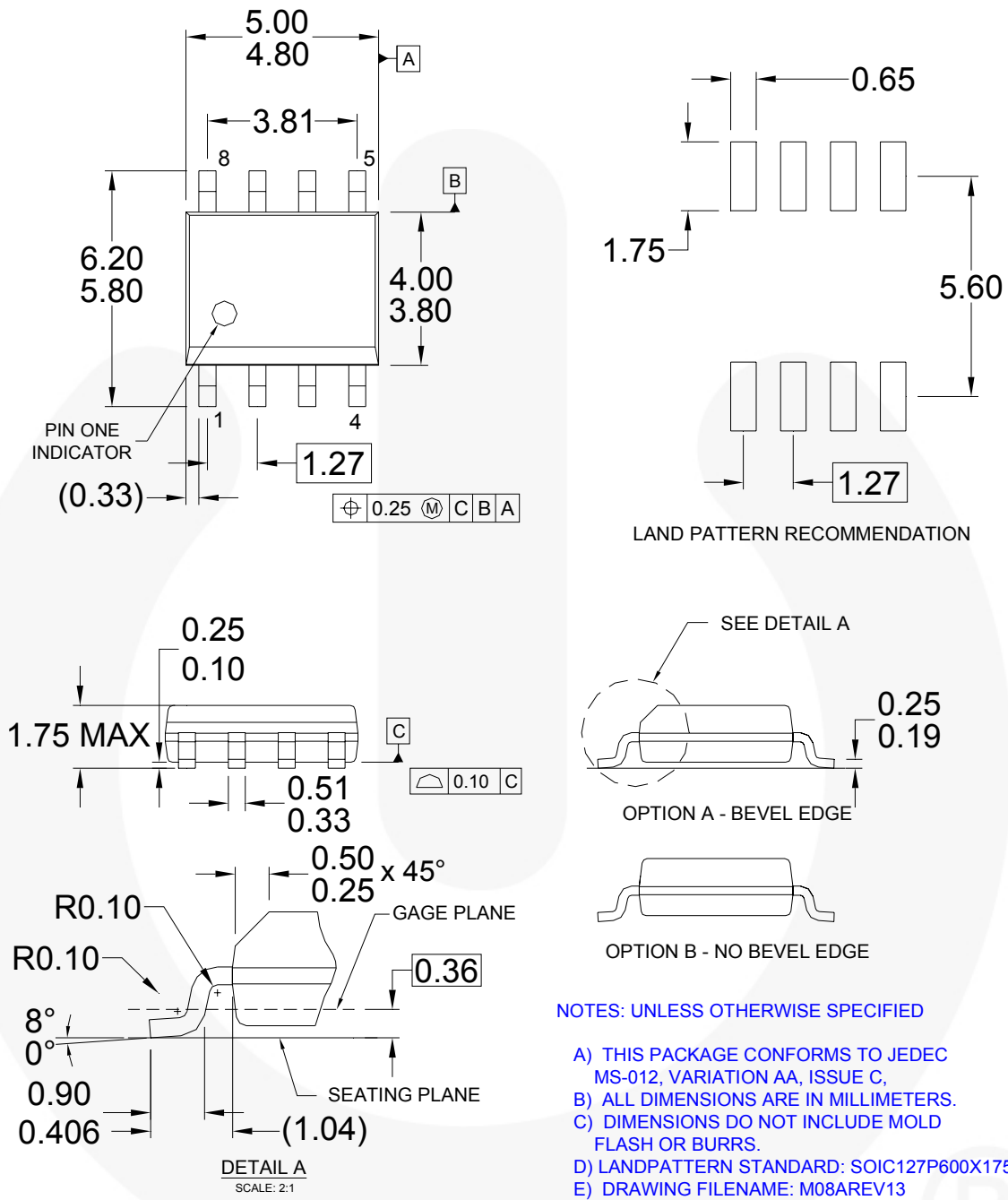

Figure 33. 8-Lead, Small Outline Package (SOP-8)



Package drawings are provided as a service to customers considering Fairchild components. Drawings may change in any manner without notice. Please note the revision and/or date on the drawing and contact a Fairchild Semiconductor representative to verify or obtain the most recent revision. Package specifications do not expand the terms of Fairchild's worldwide terms and conditions, specifically the warranty therein, which covers Fairchild products.

Always visit Fairchild Semiconductor's online packaging area for the most recent package drawings:
<http://www.fairchildsemi.com/packaging/>.



TRADEMARKS

The following includes registered and unregistered trademarks and service marks, owned by Fairchild Semiconductor and/or its global subsidiaries, and is not intended to be an exhaustive list of all such trademarks.

- | | | | |
|---|---|---|---|
| Auto-SPM™ | F-PFST™ | PowerTrench® | The Power Franchise® |
| Build it Now™ | FRFET® | PowerXS™ |  |
| CorePLUS™ | Global Power Resource™ | Programmable Active Droop™ | TinyBoost™ |
| CorePOWER™ | Green FPS™ | QFET® | TinyBuck™ |
| CROSSVOLT™ | Green FPS™ e-Series™ | QS™ | TinyLogic® |
| CTL™ | Gmax™ | Quiet Series™ | TINYOPTO™ |
| Current Transfer Logic™ | GTOT™ | RapidConfigure™ | TinyPower™ |
| EcoSPARK® | IntelliMAX™ |  | TinyPWM™ |
| EfficientMax™ | ISOPLANAR™ | Saving our world, 1mW/W at a time™ | TinyWire™ |
| EZSWITCH™ | MegaBuck™ | SmartMax™ | TriFault Detect™ |
|  | MICROCOUPLER™ | SMART START™ | TRUECURRENT™ |
|  | MicroFET™ | SPM® | μSerDes™ |
| Fairchild® | MicroPak™ | STEALTH™ |  |
| Fairchild Semiconductor® | MillerDrive™ | SuperFET™ | UHC® |
| FACT Quiet Series™ | MotionMax™ | SuperSOT™.3 | Ultra FRFET™ |
| FACT® | Motion-SPM™ | SuperSOT™.6 | UniFET™ |
| FAST® | OPTOLOGIC® | SuperSOT™.8 | VCM™ |
| FastvCore™ | OPTOPLANAR® | SupreMOS™ | VisualMax™ |
| FETBench™ |  | SyncFET™ | XS™ |
| FlashWriter® | PDP SPM™ | Sync-Lock™ | |
| FPS™ | Power-SPM™ |  | |

* Trademarks of System General Corporation, used under license by Fairchild Semiconductor.

DISCLAIMER

FAIRCHILD SEMICONDUCTOR RESERVES THE RIGHT TO MAKE CHANGES WITHOUT FURTHER NOTICE TO ANY PRODUCTS HEREIN TO IMPROVE RELIABILITY, FUNCTION, OR DESIGN. FAIRCHILD DOES NOT ASSUME ANY LIABILITY ARISING OUT OF THE APPLICATION OR USE OF ANY PRODUCT OR CIRCUIT DESCRIBED HEREIN; NEITHER DOES IT CONVEY ANY LICENSE UNDER ITS PATENT RIGHTS, NOR THE RIGHTS OF OTHERS. THESE SPECIFICATIONS DO NOT EXPAND THE TERMS OF FAIRCHILD'S WORLDWIDE TERMS AND CONDITIONS, SPECIFICALLY THE WARRANTY THEREIN, WHICH COVERS THESE PRODUCTS.

LIFE SUPPORT POLICY

FAIRCHILD'S PRODUCTS ARE NOT AUTHORIZED FOR USE AS CRITICAL COMPONENTS IN LIFE SUPPORT DEVICES OR SYSTEMS WITHOUT THE EXPRESS WRITTEN APPROVAL OF FAIRCHILD SEMICONDUCTOR CORPORATION.

As used herein:

1. Life support devices or systems are devices or systems which, (a) are intended for surgical implant into the body or (b) support or sustain life, and (c) whose failure to perform when properly used in accordance with instructions for use provided in the labeling, can be reasonably expected to result in a significant injury of the user.
2. A critical component in any component of a life support, device, or system whose failure to perform can be reasonably expected to cause the failure of the life support device or system, or to affect its safety or effectiveness.

ANTI-COUNTERFEITING POLICY

Fairchild Semiconductor Corporation's Anti-Counterfeiting Policy. Fairchild's Anti-Counterfeiting Policy is also stated on our external website, www.fairchildsemi.com, under Sales Support.

Counterfeiting of semiconductor parts is a growing problem in the industry. All manufacturers of semiconductor products are experiencing counterfeiting of their parts. Customers who inadvertently purchase counterfeit parts experience many problems such as loss of brand reputation, substandard performance, failed applications, and increased cost of production and manufacturing delays. Fairchild is taking strong measures to protect ourselves and our customers from the proliferation of counterfeit parts. Fairchild strongly encourages customers to purchase Fairchild parts either directly from Fairchild or from Authorized Fairchild Distributors who are listed by country on our web page cited above. Products customers buy either from Fairchild directly or from Authorized Fairchild Distributors are genuine parts, have full traceability, meet Fairchild's quality standards for handling and storage and provide access to Fairchild's full range of up-to-date technical and product information. Fairchild and our Authorized Distributors will stand behind all warranties and will appropriately address any warranty issues that may arise. Fairchild will not provide any warranty coverage or other assistance for parts bought from Unauthorized Sources. Fairchild is committed to combat this global problem and encourage our customers to do their part in stopping this practice by buying direct or from authorized distributors.

PRODUCT STATUS DEFINITIONS

Definition of Terms

| Datasheet Identification | Product Status | Definition |
|--------------------------|-----------------------|---|
| Advance Information | Formative / In Design | Datasheet contains the design specifications for product development. Specifications may change in any manner without notice. |
| Preliminary | First Production | Datasheet contains preliminary data; supplementary data will be published at a later date. Fairchild Semiconductor reserves the right to make changes at any time without notice to improve design. |
| No Identification Needed | Full Production | Datasheet contains final specifications. Fairchild Semiconductor reserves the right to make changes at any time without notice to improve the design. |
| Obsolete | Not In Production | Datasheet contains specifications on a product that is discontinued by Fairchild Semiconductor. The datasheet is for reference information only. |

Rev. 140